

Replacement of high-voltage battery - Observe modified procedure (139/20)

Change overview:

Version	Date	Change
0	09/21/2020	First publication
1	10/02/2020	Second publication
2	01/08/2021	<ul style="list-style-type: none"> 'Situation' section adapted Repair concept for RoW changed

Vehicle Type: **Panamera S E-Hybrid (970)**

Model Year: **As of 2014 up to 2016**

Subject: **High-voltage battery**

Information: **Modified procedure for high-voltage battery replacement**

- Due to a delay in the rollout of the battery repair concept to other markets because of training restrictions due to the Covid-19 situation, the high-voltage battery of the Cayenne S E-Hybrid (92A) must be used again in the RoW regions after the replacement high-voltage batteries for the Panamera S E-Hybrid (970) have been used up.
- Panamera batteries will be provided by PCNA's local remanufacturing partner: Spiers New Technologies.
- Once the relevant repair measure has been carried out, it may be necessary to re-program the high-voltage battery and air-conditioning control units.
- The previous Technical Information, Group 2, No. 88/19, which describes the procedure for general use of the Cayenne S E-Hybrid (92A) high-voltage battery in the Panamera S E-Hybrid (970), is no longer valid in this form and has been removed from the Porsche Central Service System (PCSS).



Information

HV battery replacement is under the Approval and Support Management process and procedures should be followed.

Remedial Action: Various repair concepts are available for the high-voltage battery, depending on the respective market. You will find the repair concept for your specific market and the relevant procedure for rectifying faults on the high-voltage battery in the ⇒ *Technical Information 'Replacement of high-voltage battery'* section.

Replacing the high-voltage battery

Work Procedure: The following repair concepts are currently available for the high-voltage battery, depending on the market:

- USA (PCNA): Coordinate approval for a replacement high-voltage battery with Technical Support of the PCNA, who will then assume responsibility for procuring the battery from Spiers Inc., see ⇒ *Technical Information 'Procedure - USA (PCNA)'*. Then return the old battery to Spiers Inc.



Information

The Canadian market is not linked to the procedure in the USA. In the event a replacement is required for the high-voltage battery, the procedure "RoW" must be used.

- All other markets incl. Canada (RoW): Order the Cayenne S E-Hybrid (92A) high-voltage battery, convert it for use in the Panamera S E-Hybrid (970) and then install it, see ⇒ *Technical Information 'Procedure - Remaining markets (RoW)'*.



Information

Procedure - USA (PCNA)



Incorrect handling of high-voltage components

- Electric shock
 - Short circuit
 - Fire
 - Explosion
- ⇒ Only appropriately trained and authorized persons are permitted to work on high-voltage vehicles and components.
- ⇒ Required qualification: High-voltage technician or high-voltage expert.
- ⇒ Observe all safety regulations.
- ⇒ Always use insulated tools, e.g. VAS 6883 High-voltage tool set, when working on these components.
- ⇒ Observe general warning notes for working on the high-voltage vehicle electrical system. ⇒ *Workshop Manual '2X00IN General warning notes for working on the high-voltage vehicle electrical system'*

 **WARNING**

Danger of fire, explosion

- **Insulation fault as a result of coolant leaking into high-voltage battery**
- ⇒ **Always drain the high-voltage battery cooling lines completely before transporting/handling the high-voltage battery.**



Information

The Canadian market is not linked to the procedure in the USA. In the event a replacement is required for the high-voltage battery, the procedure "RoW" must be used. See ⇒ *Technical Information '2X00IN Procedure - Remaining markets (RoW/China)'*.



Information

If the high-voltage battery needs to be replaced, approval must first be obtained from Technical Support of the PCNA. Once approval has been obtained, please see PPN for the ordering procedure: <https://ppn.porsche.com/portal/docs/DOC-324416>

Parts Info:

Part No.	Designation
PNA915590KX	Battery

Procedure module exchange USA

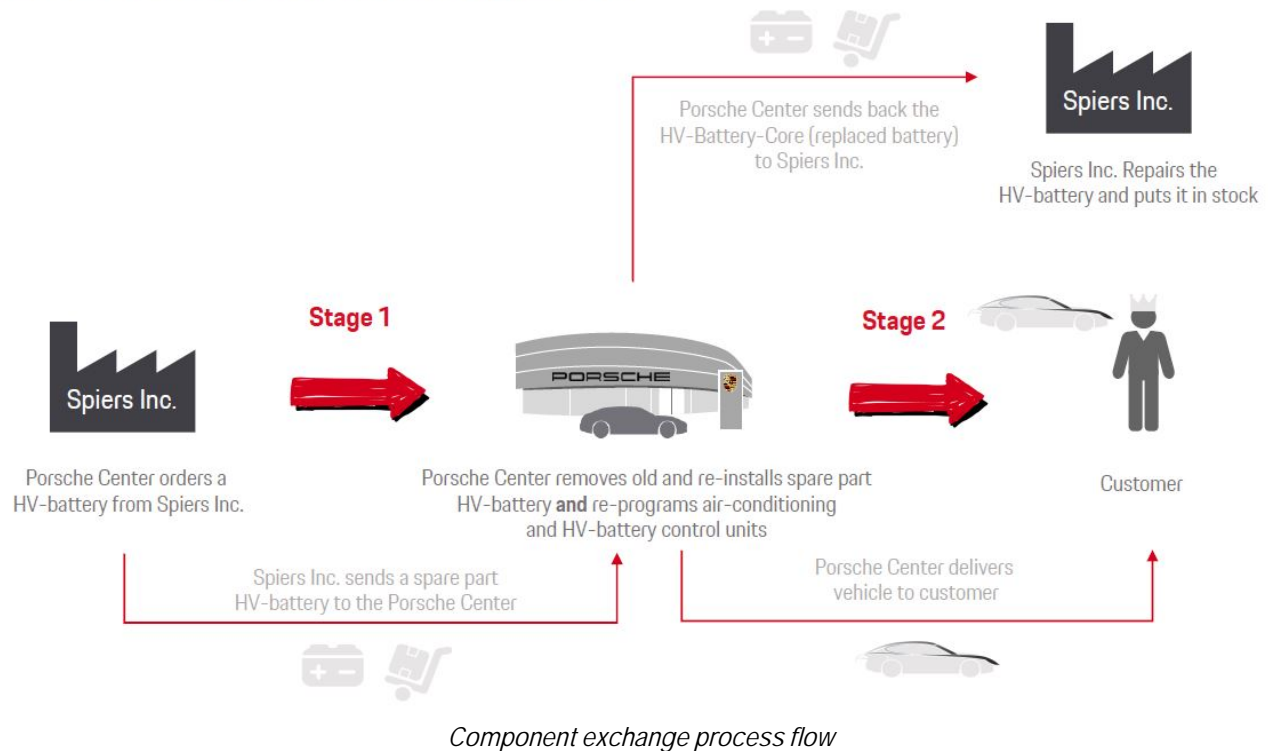

- Work Procedure: 1 **Create vehicle analysis log (VAL) using the PIWIS Tester.**
Mark the vehicle analysis log you have just created with the attribute "Initial VAL" and after programming the control units, return it using the PIWIS Tester.
- 2 Remove the old battery, see ⇒ *Workshop Manual '270855 Replacing high-voltage battery'* and then prepare for subsequent transportation to Spiers Inc. according to the respective battery status, see ⇒ *Workshop Manual '2X00IN Packing high-voltage battery with battery status "Normal" (not critical)'* or ⇒ *Workshop Manual '2X00IN Packing high-voltage battery with battery status "Warning" (critical)'*.
 - 3 Install new high-voltage battery supplied by Spiers Inc., see ⇒ *Workshop Manual '270855 Replacing high-voltage battery'*.
 - 4 **Adapt vehicle data.**
 - 4.1 In the control unit selection screen ('**Overview**' menu), press •F7" to call up the Additional menu.

- 4.2 Select '**Maintenance of vehicle data**' and press •F12" ('Next') to confirm your selection ⇒ *Maintenance of vehicle data*.
- 4.3 Press •F12" ('Next') to skip the displays containing information about vehicle description, colors/materials and X numbers.
- 4.4 Add the coding value '**ST2 - Installing HV battery (37 Ah cells)**' to the vehicle data on the second page of the M numbers. To do this, click in the "Installed" field for the relevant coding value to select the value. Make sure that the 'Installed' column is then **ticked** and that the pen symbol appears in the 'Changed' column. Then press •F12" ('Next') to exit the PR numbers display.
- 4.5 Press •F8" in the overview that is then displayed to save the changed vehicle data.
- 4.6 Once you have saved the vehicle data, press •F11" ('Back') to return to the control unit selection screen.

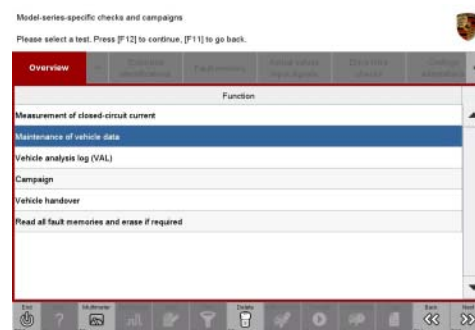

Maintenance of vehicle data

5 **Re-program control unit for high-voltage battery.**

The basic procedure for control unit programming is described in the Workshop Manual ⇒ *Workshop Manual '9X00IN Basic instructions and procedure for control unit programming using the PIWIS Tester'*.

For specific information on control unit programming during this remedial action, see the table below.

Required PIWIS Tester software version:	39.900.000 (or higher)
Type of control unit programming:	Control unit programming using the " Campaign " function in the Additional menu on the PIWIS Tester by entering a programming code.
Programming code:	C3B4V
Programming sequence:	Read and follow the information and instructions on the PIWIS Tester during the guided programming sequence. The high-voltage battery and air-conditioning control units are re-programmed and then re-coded automatically during the programming sequence. Do not interrupt programming and coding.

Software version programmed during this campaign: The software version of the programmed data record is based on the specified PIWIS Tester test software version. Please note that these may have changed in a higher version.	High-voltage battery control unit: 1300 Air-conditioning control unit: 1040 Following control unit programming, the software version can be read out of the relevant control unit in the 'Extended identifications' menu using the PIWIS Tester.
Procedure in the event of error messages appearing during the programming sequence:	⇒ <i>Workshop Manual '9X00IN Basic instructions and procedure for control unit programming using the PIWIS Tester - section on "Fault finding"</i> .



Information

Once the high-voltage battery control unit has been re-programmed, a diagnosis of the high-voltage battery is performed the next time the BUS is idle (ignition is switched off and the vehicle is locked). This process must not be interrupted. If the diagnosis is aborted because the vehicle was locked while the diagnosis was running, for example, a fault memory is stored.

6 Lock the vehicle to start on-board diagnosis of the high-voltage battery.

- 6.1 Disconnect the PIWIS Tester from the vehicle.
- 6.2 Switch off the ignition and lock the vehicle with the driver's key. Remove the driver's key and place outside the radio range of the vehicle at a distance of **at least 5 metres** from the vehicle.
- 6.3 Unlock the vehicle again after waiting **a minimum of 5 minutes**.
- 6.4 Switch on ignition.
- 6.5 Plug the PIWIS Tester diagnostic connector into the diagnostic socket again and restore communication with the vehicle.

7 Read out and erase fault memories.

- 7.1 In the control unit selection screen ('**Overview**' menu) ⇒ *Control unit selection*, press •F7" to call up the '**Additional menu**'.
- 7.2 Select the function "**Read all fault memories and erase if required**" and press •F12" ("Next") to confirm your selection ⇒ *Erasing fault memories*.



Control unit selection

The fault memories of the control units are read out.

- 7.3 Once you have read out the fault memories, check the fault memory entries.
- 7.4 Press •F8“ to delete fault memory entries.
- 7.5 Press •F12“ (“Yes”) in response to the question as to whether you really want to delete all fault memory entries.

The faults stored in the fault memories of the various control units are deleted.

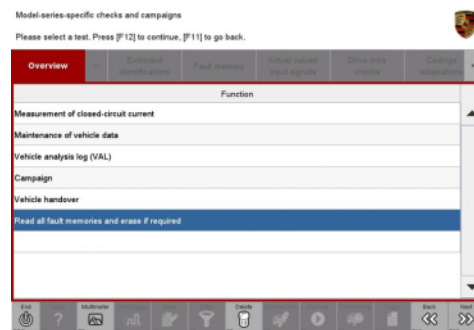

Erasing fault memories

8 **Create a vehicle analysis log (VAL) using the PIWIS Tester.**

Mark the vehicle analysis log you have just created with the attribute "Final VAL" and return it using the PIWIS Tester.



Information

If the workshop campaign ⇒ *Technical Information 'WKK500 WKK5 Workshop campaign -Re-programming air conditioning and high-voltage battery control units'* has not yet been carried out on the vehicle, **do not** start this workshop campaign.

When the programming mentioned above is performed, the relevant control units are programmed to the current software version.

Campaign WKK5 must be closed by performing a recall update (warranty claim with 0 time units and no material items) for the affected vehicles.

- 9 Once the vehicle has been repaired successfully, send the old high-voltage battery to Spiers Inc. for repairs and storage.

Invoicing:



Information

If there is a warranty-relevant defect, it can be invoiced using the existing high-voltage battery warranty.

In the event of an expired high-voltage battery warranty and an existing PAW, then if a technical defect is the case (not caused by wear) an application for invoicing for ageing and wear must be completed. The costs can also be invoiced under "External service" in the warranty claim following a successful test.

For documentation and warranty invoicing, select the labor operations and PQIS coding specified below for the relevant repairs and enter them in the warranty claim:

APOS	Labour operation	I No.
03350053	Self-diagnosis (create VAL)	
27085515	Replacing high-voltage battery	
27942565	Programming high-voltage battery control unit	

PQIS coding:

Location (FES5)	27080	High-voltage battery
Damage type (SA4)	1824	Severe wear

References: ⇒ *Workshop Manual '270855 Replacing high-voltage battery'*
 ⇒ *Workshop Manual '2X00IN Packing high-voltage battery with battery status "Normal" (not critical)'*
 ⇒ *Workshop Manual '2X00IN Packing high-voltage battery with battery status "Warning" (critical)'*

Procedure - Remaining markets (RoW)

WARNING

Incorrect handling of high-voltage components

- Electric shock
 - Short circuit
 - Fire
 - Explosion
- ⇒ Only appropriately trained and authorized persons are permitted to work on high-voltage vehicles and components.
- ⇒ Required qualification: High voltage technician or high voltage expert.
- ⇒ Observe national requirements and legislation for this work.
- ⇒ Always use insulated tools, e.g. VAS 6883 High voltage tool set, when working on these components.
- ⇒ Observe general warning notes for working on the high-voltage vehicle electrical system. ⇒ *Workshop Manual '2X00IN General warning notes for working on the high-voltage vehicle electrical system'*

WARNING

Danger of fire, explosion

- Insulation fault as a result of coolant leaking into high-voltage battery
- ⇒ Always drain the high-voltage battery cooling lines completely before transporting/handling the high-voltage battery.



Information

The procedure described for replacement of the high-voltage battery will be successively replaced by a high-voltage battery repair at the Porsche dealer. A corresponding training concept is currently being developed. The Porsche dealer will then be trained to carry out the repair process independently.

Procedure exchange of complete battery RoW and China

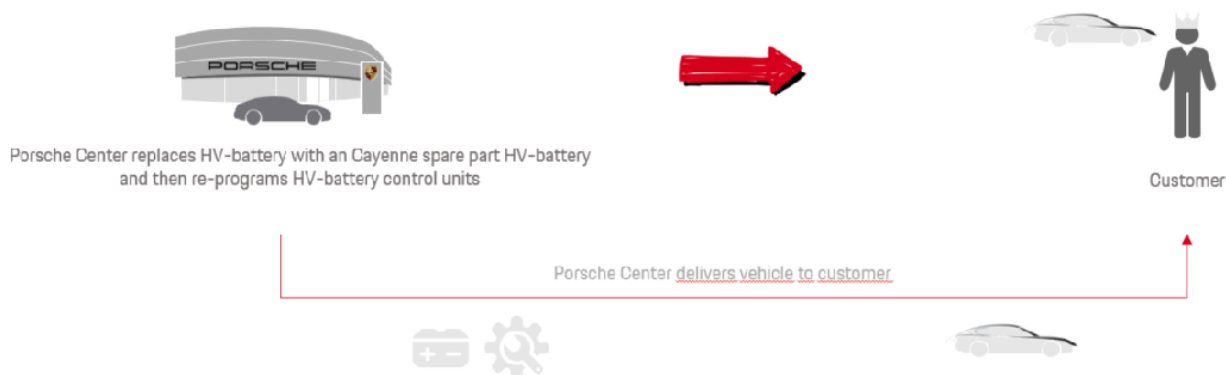

Process flow for exchange of complete battery

Work Procedure: Order the Cayenne S E-Hybrid (92A) high-voltage battery and convert it for installation in the Panamera S E-Hybrid (970).

Parts required

Parts Info:	Part No. 958611590DX	Designation ⇒ High-voltage battery	Qty. 1 ea.
-------------	--------------------------------	--	----------------------

Materials:	Part No. 00004330516	Designation ⇒ Coolant additive	Qty. 20-litre container (approx. 1 litre required per vehicle)
------------	--------------------------------	--	---

Required tools

- | | |
|--------|--|
| Tools: | <ul style="list-style-type: none"> • 3033 - Lifting tackle • 9860 - Adapter plate • VAS 6100 Workshop crane • 9703 - Flexible screwdriver • VAS 6890 Spring band clamp pliers |
|--------|--|

- VAG 1274B Cooling system tester
- 9696 - Filling device
- VAS 6096/2 Vacuum pump
- VAS 6562 Porsche adapter set for cooling system tester
- 9900 - PIWIS Tester 3
- Torque wrench, 0.4 - 2 Nm (0.3 - 1.5 ftlb.), e.g. **VAS 6253A Torque wrench, 0.4 - 2 Nm (0.3 - 1.5 ftlb.)**
- Torque wrench, 2 - 10 Nm (1.5 - 7.5 ftlb.), e.g. **VAG 1783 Torque wrench, 2 - 10 Nm (1.5 - 7.5 ftlb.)**
- Torque wrench, 6 - 50 Nm (4.5 - 37 ftlb.), e.g. **VAG 1331A Torque wrench, 6 - 50 Nm (4.5 - 37 ftlb.)**
- Torque wrench, 20 - 100 Nm (15 - 74 ftlb.), e.g. **VAS 5820 Torque wrench, 20 - 100 Nm (15 - 74 ftlb.)**

Converting and replacing high-voltage battery



Information

A log must be filled out during the repair measure and this must be attached to the warranty claim. To do this, use the document "**Attachment for TI 139/20: Rework log – Replacing high-voltage battery**".

Work Procedure: 1 **Create vehicle analysis log (VAL) using the PIWIS Tester.**

Mark the vehicle analysis log you have just created with the attribute "Initial VAL" and once the high-voltage battery has been installed, return it using the PIWIS Tester.

2 **Remove high-voltage battery.**

- 2.1 Observe warning notes ⇒ *Workshop Manual '2X00IN General warning notes for working on the high-voltage vehicle electrical system'*.
- 2.2 Carry out classification of high-voltage battery ⇒ *Workshop Manual '2X00IN Classification of high-voltage battery'*.
- 2.3 Isolate the high-voltage system from the power supply and complete the relevant documentation ⇒ *Workshop Manual '2X00IN Isolating high-voltage system from power supply/Starting high-voltage system'*.
- 2.4 Remove subwoofer ⇒ *Workshop Manual '2X00IN Removing and installing subwoofer (hybrid)'*.
- 2.5 Remove luggage compartment cover ⇒ *Workshop Manual '2X00IN Removing and installing centre luggage compartment trim panel (luggage compartment cover)'*.
- 2.6 Remove C-pillar trim panel ⇒ *Workshop Manual '2X00IN Removing and installing C-pillar trim panel'*.
- 2.7 Remove side trim panel for rear luggage compartment ⇒ *Workshop Manual '2X00IN Removing and installing side trim panel for rear luggage compartment'*.

- 2.8 Remove cover for rear lock support ⇒ *Workshop Manual '2X00IN Removing and installing cover for rear lock support'*.
- 2.9 Remove vehicle electrical system battery ⇒ *Workshop Manual '2X00IN Removing and installing battery'*.
- 2.10 Remove antenna for Porsche Entry & Drive in the luggage compartment ⇒ *Workshop Manual '2X00IN Removing and installing KESSY antenna'*.
- 2.11 Remove high-voltage charger ⇒ *Workshop Manual '2X00IN Removing and installing high-voltage charger'*.
- 2.12 Remove high-voltage battery ⇒ *Workshop Manual '2X00IN Removing and installing high-voltage battery'*.

3 Convert new high-voltage battery.

- 3.1 Check the new high-voltage battery ⇒ *Hollow section -2-* and if the hollow section ⇒ *Hollow section -1-* is fitted, this must be removed. To do this, unscrew the two fastening screws for the hollow section.

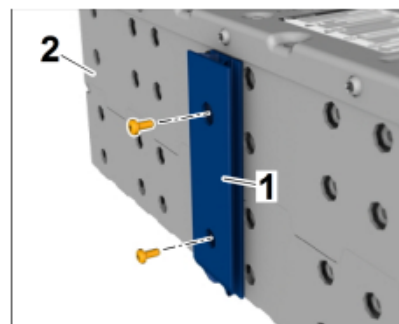

Hollow section

- 3.2 Remove equipotential bonding line ⇒ *Equipotential bonding line -1-* from the removed high-voltage battery and fit it on the new high-voltage battery.

Tightening torque 17 Nm (13ftlb.)



Information

The fastening screws for the battery cross member will be re-used.

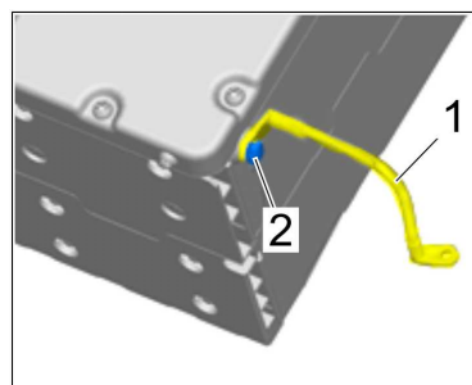

Equipotential bonding line

4 Replace high-voltage battery.

Remove battery cross member together with the heater for the high-voltage battery from the removed high-voltage battery and fit them on the new high-voltage battery.

For instructions, see ⇒ *Workshop Manual '2X00IN Replacing high-voltage battery'*.

Part No.	Designation	Qty.
958611590DX	High-voltage battery	1 ea.

- 5 Carefully pull off the existing part identification sticker from the battery cross member ⇒ *Part identification on battery cross member -1-*. Carefully remove any adhesive residue left behind.

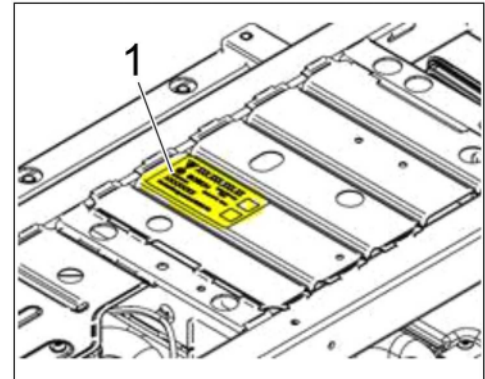

Part identification on battery cross member

6 **Install new high-voltage battery.**

- 6.1 Install high-voltage battery ⇒ *Workshop Manual '2X00IN Removing and installing high-voltage battery'*.
- 6.2 Install high-voltage charger ⇒ *Workshop Manual '2X00IN Removing and installing high-voltage charger'*.
- 6.3 Install vehicle electrical system battery ⇒ *Workshop Manual '2X00IN Removing and installing battery'*.
- 6.4 Install antenna for Porsche Entry & Drive in the luggage compartment ⇒ *Workshop Manual '2X00IN Removing and installing KESSY antenna'*.
- 6.5 Install C-pillar trim panel ⇒ *Workshop Manual '2X00IN Removing and installing C-pillar trim panel'*.
- 6.6 Install side trim panel for rear luggage compartment ⇒ *Workshop Manual '2X00IN Removing and installing side trim panel for rear luggage compartment'*.
- 6.7 Install cover for rear lock support ⇒ *Workshop Manual '2X00IN Removing and installing cover for rear lock support'*.
- 6.8 Install luggage compartment cover ⇒ *Workshop Manual '2X00IN Removing and installing centre luggage compartment trim panel (luggage compartment cover)'*.
- 6.9 Install subwoofer ⇒ *Workshop Manual '2X00IN Removing and installing subwoofer (hybrid)'*.
- 6.10 Start the high-voltage system and complete the documentation ⇒ *Workshop Manual '2X00IN Isolating high-voltage electrical system from power supply/Starting high-voltage electrical system'*.

7 **Adapt vehicle data.**

- 7.1 In the control unit selection screen ('**Overview**' menu), press **•F7** to call up the Additional menu.

7.2 Select **'Maintenance of vehicle data'** and press **•F12** ("Next") to confirm ⇒ *Maintenance of vehicle data*.

7.3 Press **•F12** ("Next") to skip the displays containing information about vehicle description, colors/materials and X numbers.

7.4 Add the coding value **'ST1 - Installing E2 HV battery (28 Ah cells)'** to the vehicle data on the second page of the M numbers. To do this, click in the "Installed" field for the relevant coding value to select the value.

Make sure that the 'Installed' column is then **ticked** and that the pen symbol appears in the 'Changed' column.

Then press **•F12** ("Next") to exit the PR numbers display.

7.5 Press **•F8** in the overview that is then displayed to save the changed vehicle data.

7.6 Once you have saved the vehicle data, press **•F11** ("Back") to return to the control unit selection screen.

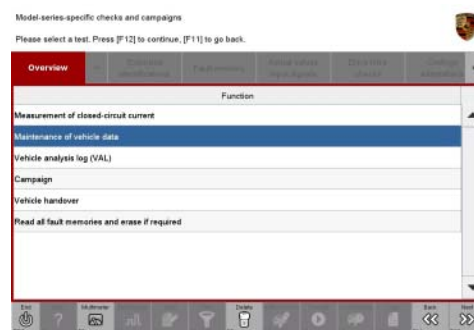

Maintenance of vehicle data

8 Re-program control unit for high-voltage battery.

The basic procedure for control unit programming is described in the Workshop Manual ⇒ *Workshop Manual '9X00IN Basic instructions and procedure for control unit programming using the PIWIS Tester'*.

For specific information on control unit programming as part of this programming process, see the table below.

Required PIWIS Tester software version:	39.900.000 (or higher)
Type of control unit programming:	Control unit programming using the 'Campaign' function in the Additional menu on the PIWIS Tester by entering a programming code.
Programming code:	T2L5V
Programming sequence:	Read and follow the information and instructions on the PIWIS Tester during the guided programming sequence. The high-voltage battery control unit is re-programmed and then re-coded automatically during the programming sequence. Do not interrupt programming and coding.
Programming time (approx.):	6 minutes

Software version programmed during this campaign:	1200 Following control unit programming, the software version can be read out of the high-voltage battery control unit in the 'Extended identifications' menu using the PIWIS Tester.
Procedure in the event of error messages appearing during the programming sequence:	⇒ <i>Workshop Manual '9X00IN Basic instructions and procedure for control unit programming using the PIWIS Tester - section on "Fault finding"</i> .

9 Read out and erase fault memories.

9.1 In the control unit selection screen ('Overview' menu) ⇒ *Control unit selection*, press •F7" to call up the '**Additional menu**'.

9.2 Select the function "**Read all fault memories and erase if required**" and press •F12" ("Next") to confirm ⇒ *Erasing fault memories*.



Control unit selection

The fault memories of the control units are read out.

9.3 Once you have read out the fault memories, check the fault memory entries.

9.4 Press •F8" to delete fault memory entries.

9.5 Press •F12" ("Yes") in response to the question as to whether you really want to delete all fault memory entries.

The faults stored in the fault memories of the various control units are deleted.

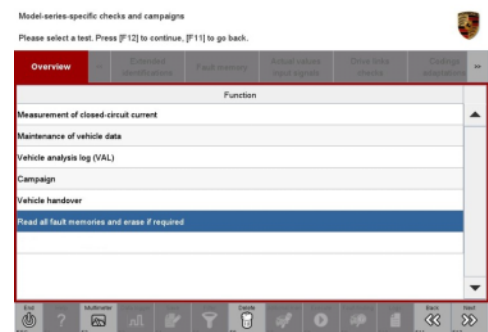

Erasing fault memories

10 Create a vehicle analysis log (VAL) using the PIWIS Tester.

Mark the vehicle analysis log you have just created with the attribute "Final VAL" and return it using the PIWIS Tester.

11 Complete the rework log and attach it to the warranty claim.

To do this, use the document "**Attachment to TI 139/20: Rework log – Replacing high-voltage battery**".



Information

If the workshop campaign ⇒ *Technical Information '9X00IN WKK5 Workshop campaign - Re-programming air-conditioning and high-voltage battery control units'* has not yet been carried out on the vehicle, **do not** perform this workshop campaign.

When the programming mentioned above is performed, the relevant control units are programmed to the current software version.

Campaign WKK5 must be closed by performing a recall update (warranty claim with 0 time units and no material items) for the affected vehicles.



Information

After carrying out the repair measure described here, **pay particular attention** to the following:

- **Capacity of the installed high-voltage battery**

The capacity of the high-voltage battery is set to **24 Ah** following installation in the Panamera S E-Hybrid and thus corresponds to the capacity of the high-voltage battery originally installed in the Panamera S E-Hybrid.

- **Electric range display**

When driving using electric power only in the "E-Power" driving programme, the internal combustion engine may be switched on although the remaining electric range displayed is still up to 4 km (2.5 miles). This is not a malfunction because the electric range is estimated. The electric range depends on driving style, climatic conditions and the use of energy-intensive electrical loads. Please inform the customer about this.

Invoicing:



Information

If there is a warranty-relevant defect, it can be invoiced using the existing high-voltage battery warranty.

In the event of an expired high-voltage battery warranty and an existing PAW, then if a technical defect is the case (not caused by wear) an application for invoicing for ageing and wear must be completed. The costs can also be invoiced under "External service" in the warranty claim following a successful test.

For documentation and warranty invoicing, enter the labor operation, PQIS coding and part number specified below in the warranty claim:

APOS	Labor operation	I No.
03350053	Self-diagnosis (create VAL)	
27083119	Converting high-voltage battery	

PQIS coding:

Location (FES5)	27080	High-voltage battery
Damage type (SA4)	1824	Severe wear

Parts Info:

Part No.	Designation	Qty.
958611590DX	High-voltage battery	1 ea.
00004330516	Coolant additive	0.05 ea. (= approx. 1 litres)

- References:
- ⇒ *Workshop Manual '9X00IN General warning notes for working on the high-voltage electrical system'*
 - ⇒ *Workshop Manual '9X00IN Classification of high-voltage battery'*
 - ⇒ *Workshop Manual '9X00IN Isolating high-voltage electrical system from power supply/Starting high-voltage electrical system'*
 - ⇒ *Workshop Manual '9X00IN Removing and installing subwoofer (hybrid)'*
 - ⇒ *Workshop Manual '9X00IN Removing and installing centre trim panel for luggage compartment (loadspace cover)'*
 - ⇒ *Workshop Manual '9X00IN Removing and installing C-pillar trim panel'*
 - ⇒ *Workshop Manual '9X00IN Removing and installing side trim panel for rear luggage compartment'*
 - ⇒ *Workshop Manual '9X00IN Removing and installing cover for rear lock carrier'*
 - ⇒ *Workshop Manual '9X00IN Removing and installing battery'*
 - ⇒ *Workshop Manual '9X00IN Removing and installing Kessy antenna'*
 - ⇒ *Workshop Manual '9X00IN Removing and installing high-voltage charger'*
 - ⇒ *Workshop Manual '9X00IN Removing and installing high-voltage battery'*
 - ⇒ *Workshop Manual '9X00IN Replacing high-voltage battery'*
 - ⇒ *Workshop Manual '9X00IN Basic instructions and procedure for control unit programming using the PIWIS Tester'*

Important Notice: Technical Bulletins issued by Porsche Cars North America, Inc. are intended only for use by professional automotive technicians who have attended Porsche service training courses. They are written to inform those technicians of conditions that may occur on some Porsche vehicles, or to provide information that could assist in the proper servicing of a vehicle. Porsche special tools may be necessary in order to perform certain operations identified in these bulletins. Use of tools and procedures other than those Porsche recommends in these bulletins may be detrimental to the safe operation of your vehicle, and may endanger the people working on it. Properly trained Porsche technicians have the equipment, tools, safety instructions, and know-how to do the job properly and safely. Part numbers listed in these bulletins are for reference only. The work procedures updated electronically in the Porsche PIWIS diagnostic and testing device take precedence and, in the event of a discrepancy, the work procedures in the PIWIS Tester are the ones that must be followed.

© 2021 Porsche Cars North America, Inc.