



Technical Service Bulletin

SUBJECT:			No: TSB-20-23-001REV
POTENTIAL TRANSMISSION SHUDDER/SURGE WITH POSSIBLE DTC (CVT-8) - REVISED			DATE: June 2020
			MODEL: See below
CIRCULATE TO:	<input type="checkbox"/> GENERAL MANAGER	<input checked="" type="checkbox"/> PARTS MANAGER	<input checked="" type="checkbox"/> TECHNICIAN
<input checked="" type="checkbox"/> SERVICE ADVISOR	<input checked="" type="checkbox"/> SERVICE MANAGER	<input checked="" type="checkbox"/> WARRANTY PROCESSOR	<input type="checkbox"/> SALES MANAGER

This bulletin supersedes TSB-20-23-001, issued April, 2020, to update the Control Valve part number and make it applicable to all models and model years listed below. Revisions are italicized and indicated by ◀.

PURPOSE

Certain vehicles with F1CJC/W1CJC (CVT-8) transmissions may exhibit a shudder or surge condition possibly caused by poor reaction of the hydraulic pressure circuit. With continued driving under these conditions, the CVT belt may slip repeatedly when accelerating, and abrasion powder may enter the hydraulic pressure circuit, causing a warning light to turn on with one of the following DTCs: P0776, P0730, P0741, P084A, P0969, P2719. The shudder/surge condition may also be described as engine flare, lack of acceleration, and/or car shake.

This TSB instructs dealers to diagnose and test drive vehicles exhibiting this condition. For all vehicles, verify that SR-16-006 has been completed for vehicles listed in that Recall bulletin (2016 Lancer, 2016 Outlander, and 2015-2016 Outlander Sport: CVT ECU should be updated to the software numbers listed in the "CVT ECU Reprogramming Chart" in this TSB, or higher). If any of the DTCs previously listed are present, dealers are required to submit data from MUTIII-SE, create a Techline case, follow inspection procedures related to recorded DTCs, and make necessary repair based on results. A replacement transmission should ONLY be ordered if approved by Techline or your DPSM.

AFFECTED VEHICLES

The following vehicles equipped with F1CJC/W1CJC (CVT-8) transmissions ONLY:

- 2018 - 2020 Eclipse Cross*
- 2016 - 2017 Lancer with 2.0L/2.4L engine
- 2016 - 2020 Outlander with 2.4L engine*
- 2015 - 2020 Outlander Sport/RVR with 2.0L engine*
- 2018-2020 Outlander Sport/RVR with 2.4L engine*◀

* This TSB may also apply to later model years with F1CJC/W1CJC (CVT-8) transmissions.

NOTE: This TSB should be performed on a customer complaint basis only.

CVT ECU REPROGRAMMING CHART (only for models listed in SR-16-006)

NOTE: If SR-16-006 shows as an open Recall in the Warranty Superscreen, then SR-16-006 must be completed. Once completed, the CVT ECU should then display the software numbers listed below.

Model	ECU Part Number	Data No.	Software Part Number	
			Previous	New
2016 Lancer (2.0L/4B11) (CY0A, CX0A; F1CJC, W1CJC)	8631B482	8631B802	8631B482 0A 8631B482 0B	8631B482 0C
2016 Lancer (2.4L/4B12) (CY0A, CX0A; F1CJC, W1CJC)	8631B483	8631B803	8631B483 0A 8631B483 0B	8631B483 0C
2016 Outlander (2.4L/4J12) (GF0W; F1CJC, W1CJC)	8631B371	8631B788	8631B371 0A 8631B371 0B 8631B371 0C	8631B371 0D
2015 Outlander Sport/RVR (2.0L/4B11) (GA0W; F1CJC, W1CJC)	8631B287	8631B780	8631B287 0A 8631B287 0B 8631B287 0C	8631B287 0D

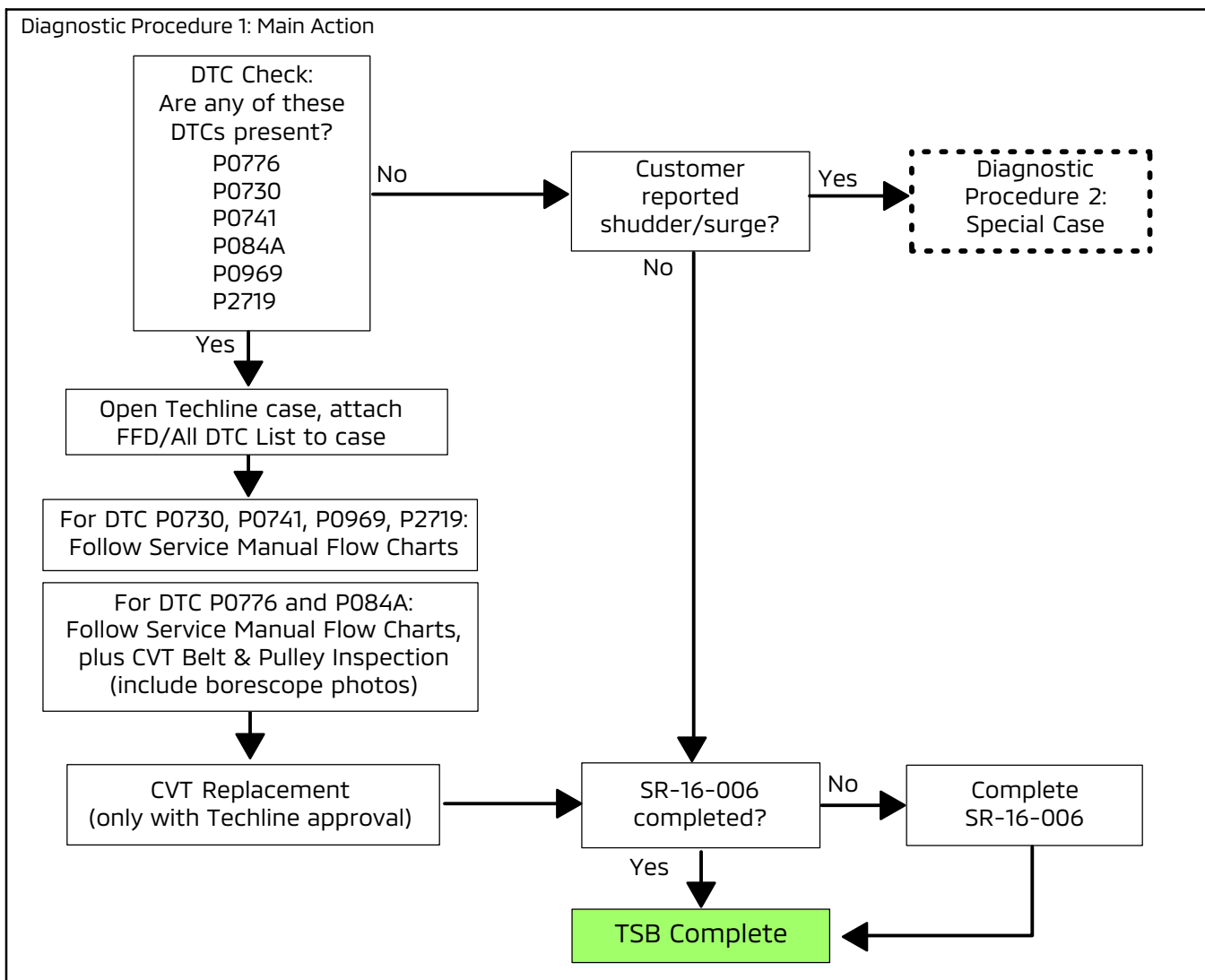
REPAIR PROCEDURE

DIAGNOSTIC PROCEDURE 1: MAIN ACTION

1. Connect MUT-III to the vehicle and check for **any** of the following DTCs stored in the CVT ECU: P0776, P0730, P0741, P084A, P0969, P2719.

Are any of the DTCs listed above stored in the CVT ECU?

- **YES** - Go to step 3.
- **NO** - Go to step 2.

2. Did customer report that the vehicle exhibited (currently or previously) a shudder or surge condition? (This condition may also be described as engine flare, lack of acceleration, and/or car shake.)

- **YES** - Go to "Diagnostic Procedure 2: Special Case" in this TSB.
- **NO** - Go to step 4 to verify that SR-16-006 has been completed for vehicles listed in that Recall bulletin (2016 Lancer, 2016 Outlander, and 2015-2016 Outlander Sport).

3. If any of the DTCs listed in step 1 are stored in the CVT ECU, perform the steps below.
 - a. Using MUT3-SE save an "ALL DTC" list or "Freeze Frame Data" file displaying the vehicle's VIN **and** all accompanying DTCs.

For instructions on saving an "ALL DTC" list and "Freeze Frame Data" file and attaching to a Techline case, go to:

- MDL > service > systems > Techline > Techline system
- Click on the "HOW-TO" Instructions button, and follow instructions under "DTC LISTS" and "FREEZE FRAME DATA."

NOTE: A "screen shot" will NOT be accepted as it does not include the vehicle's VIN.

The image illustrates the navigation path for finding diagnostic instructions. On the left, a screenshot of the Techline System website shows the 'HOW-TO' Instructions button highlighted with a red arrow. On the right, a 'HOW-TO' INSTRUCTIONS menu is shown with the 'DTC LISTS' dropdown highlighted by a red arrow. Next to the menu is a 3D rendering of a spiral-bound notebook titled 'HOW TO instructions' with the subtitle 'What You Need to Know!'. Below the notebook is the Mitsubishi Motors logo and the text 'CHOOSE A TOPIC FROM THE MENU ON THE LEFT.....'

- b. Create a Techline case and attach the files to the Techline case.
- c. For DTCs P0730, P0741, P0969, P2719:
Follow the Flow chart in the applicable Service Manual.
Group 23A -> Diagnosis <CVT> -> Diagnostic Trouble Code Procedures.

For DTCs P0776 and P084A:

Follow the Flow Chart in the applicable Service Manual, then follow the inspection of the CVT Belt and Pulley system as outlined later in this TSB, in the section called "**CVT Belt and Pulley Inspection.**"

- d. Contact Techline for assistance.
- e. Depending on diagnosis, and instruction from Techline, order replacement parts as needed. Refer to Parts Information in this TSB for the correct part number.
- f. If applicable, replace the CVT-8 transaxle or the valve body, then perform the CVT ECU coding procedures found in TSB-15-23-001, "F1CJC/W1CJC CVT ECU Coding Procedure."
4. If vehicle is listed in SR-16-006: Look up the vehicle's VIN in the Warranty Superscreen and verify that SR-16-006 has been completed.

Has SR-16-006 been completed?

- **YES** - Repair is complete.
- **NO** - Complete SR-16-006.

NOTE: All CAN reprogramming is now performed with MUT3-SE. Refer to TIN-17-00-001REV for more details on the updated procedures with MUT3-SE.

DIAGNOSTIC PROCEDURE 2: SPECIAL CASE

ONLY if customer reports a shudder/surge condition, follow this procedure **before** replacing the CVT-8 transmission.

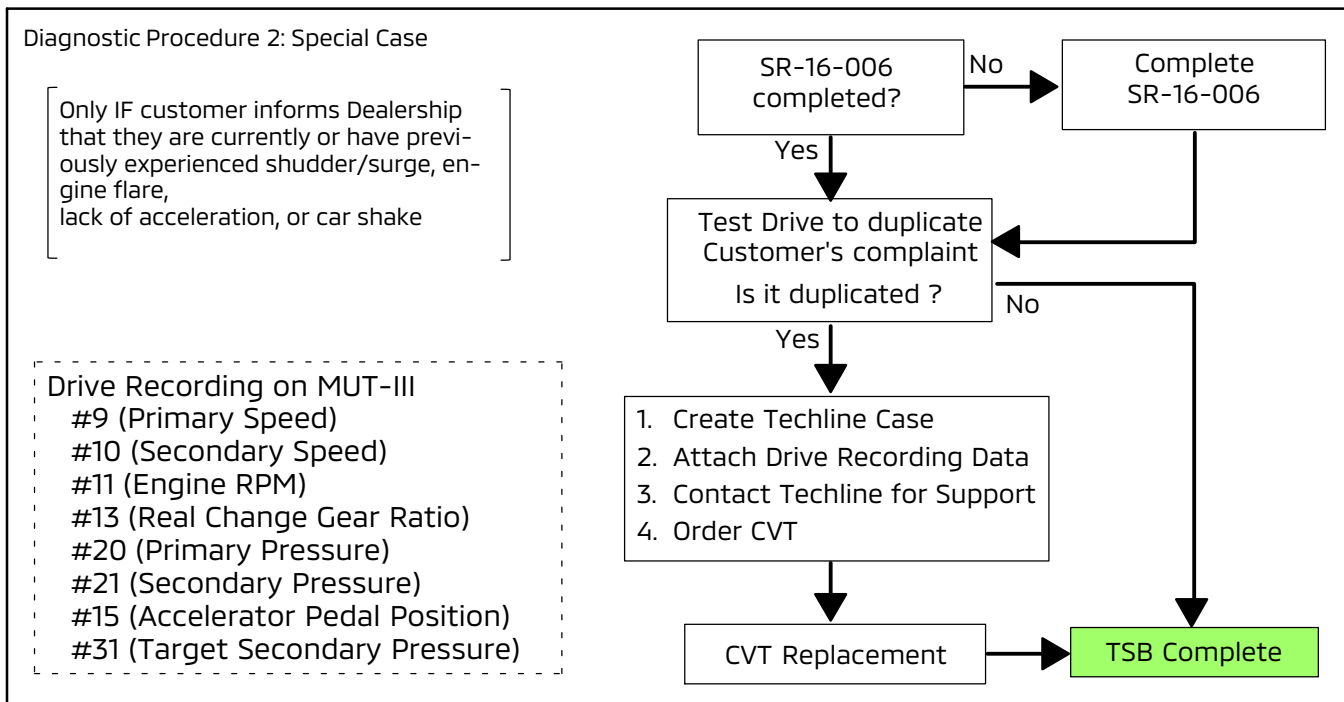

1. Look up the vehicle's VIN in the Warranty Superscreen and verify that SR-16-006 has been completed (for 2016 Lancer, 2016 Outlander, and 2015-2016 Outlander Sport). If not completed, perform SR-16-006, then go to step 2.
2. Test drive the vehicle to see if the shudder/surge condition can be duplicated.
 - a. Refer to "Figure 1: Test Drive Procedure for Duplicating CVT-8 Belt Slip" on next page.
 - b. Setup MUT-III with the applicable Drive Recording parameters listed in the "Diagnostic Procedure 2: Special Case" diagram above.



For instructions on setting up Drive Recordings in **MUTIII-SE**:

- Using MEDIC, from the main page, click the "MUT3-SE" icon at the top center of the screen to open MUT-III SE.
- Click on the MUTIII-SE User's Manual button in lower left corner; go to Chapter 5: Drive Recorder.
- Set the Manual Trigger to index the recording when the shudder/surge condition is noticed.

- c. Follow the Test Drive procedures to duplicate these conditions. Set the Manual Trigger when the shudder/surge condition is noticed.

⚠ WARNING Test drive route should be relatively free from other traffic so you can safely conduct the test and concentrate on vehicle operation and performance. **ALWAYS follow all traffic laws and safe driving practices.**

Figure 1: Test Drive Procedure for Duplicating CVT-8 Belt Slip

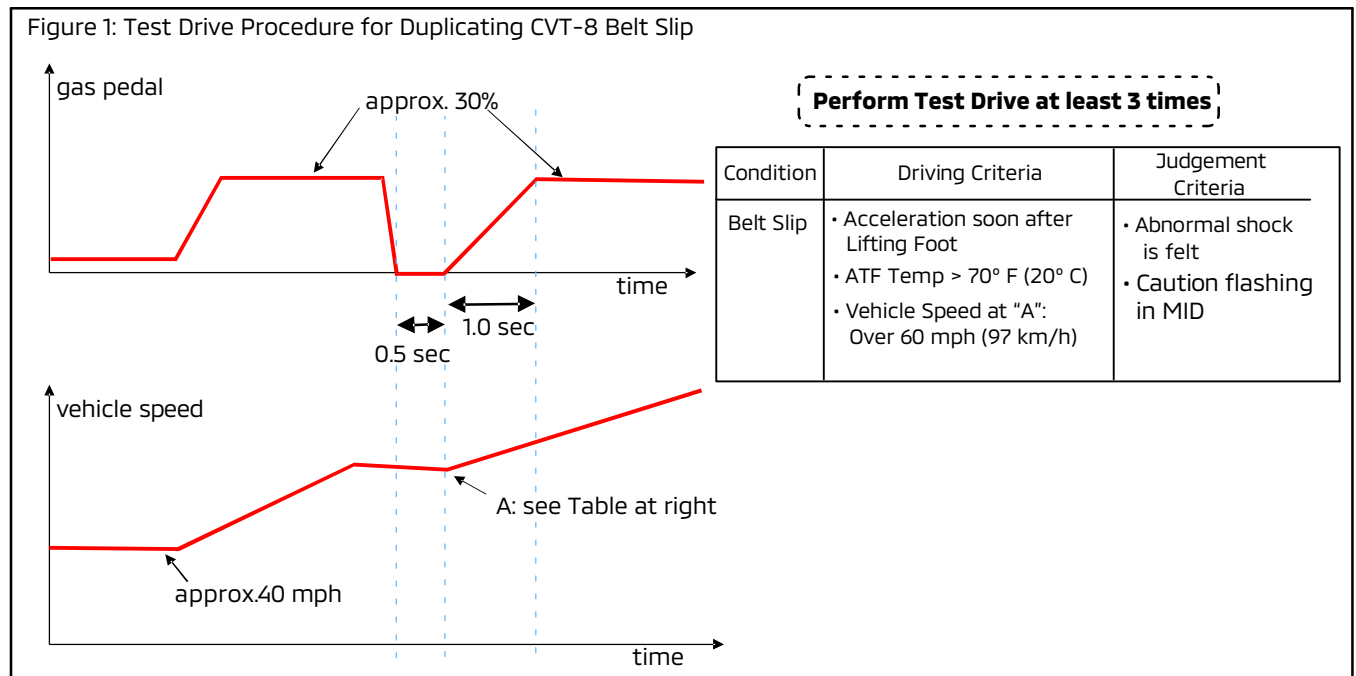

3. Was the shudder/surge condition duplicated?
 - **YES** - Go to step 4.
 - **NO** - Repair is complete. Return vehicle to customer.
4. Create a Techline case.
5. Attach the following Drive Recording Data from MUT-III to the Techline case.

No.	Description	No.	Description
9	Primary Speed	20	Primary Pressure
10	Secondary Speed	21	Secondary Pressure
11	Engine RPM	15	Accelerator Pedal Position
13	Real Change Gear Ratio	31	Target Secondary Pressure

For instructions on attaching a Drive Recording to a Techline case, go to:

- MDL > service > systems > Techline > Techline system
- Click on the "HOW-TO" Instructions button, and follow instructions under "DRIVE RECORDINGS" and "3. Attach A Drive Recording To A Techline Case."

The image shows two parts: a screenshot of the Techline System web interface and a graphic for 'HOW-TO' instructions.

Techline System Screenshot: The interface displays a 'Techline Alerts' section with a red arrow pointing to the 'HOW-TO' Instructions button in the 'Techline FAQs' section at the bottom.

'HOW-TO' INSTRUCTIONS Graphic: This graphic features the Mitsubishi Motors logo, a gear icon, and a spiral-bound notebook titled 'HOW TO instructions "What You Need to Know!"'. A red arrow points to the 'DRIVE RECORDINGS' menu item in the left-hand navigation menu. Below the notebook, text reads: 'CHOOSE A TOPIC FROM THE MENU ON THE LEFT.....'

6. Contact Techline for assistance.
7. Depending on diagnosis, and instruction from Techline, order replacement parts as needed. Refer to Parts Information in this TSB for the correct part number.
8. If applicable, replace the CVT-8 transaxle or the valve body, then perform the CVT ECU coding procedures found in TSB-15-23-001, "F1CJC/W1CJC CVT ECU Coding Procedure."

CVT BELT AND PULLEY INSPECTION

For DTCs P0776 and P084A, follow the Flow Chart in the applicable Service Manual, then follow the steps below to complete CVT belt and pulley inspection.

Attach any borescope photos to the Techline case. Then contact Techline for assistance. Return to step 6 above.

**CVT
 DIAGNOSTIC TROUBLE CODE PROCEDURES**

DTC P0776: Abnormality in Secondary Pressure Solenoid Valve Function

DIAGNOSTIC FUNCTION

TCM conducts fault detection by measuring the difference between the target value and the actual value for the secondary pressure.

MONITOR EXECUTION

- Voltage of battery: 10 volts or more.

DESCRIPTIONS OF MONITOR METHODS

The following three conditions are met for 10 seconds.

- The engine is running.
- Selector lever position: Other than P, N
- Fluid temperature: More than -20°C (-4°F)
- Difference between the target secondary pressure and actual secondary pressure is 1.2 MPa (174 psi) or more.

MONITOR EXECUTION CONDITIONS (OTHER MONITOR AND SENSOR)

Other Monitor (There is no temporary DTC stored in memory for the item monitored below)

- Not applicable

Sensor (The sensor below is determined to be normal)

- Not applicable

LOGIC FLOW CHARTS (Monitor Sequence–Output Functional High)

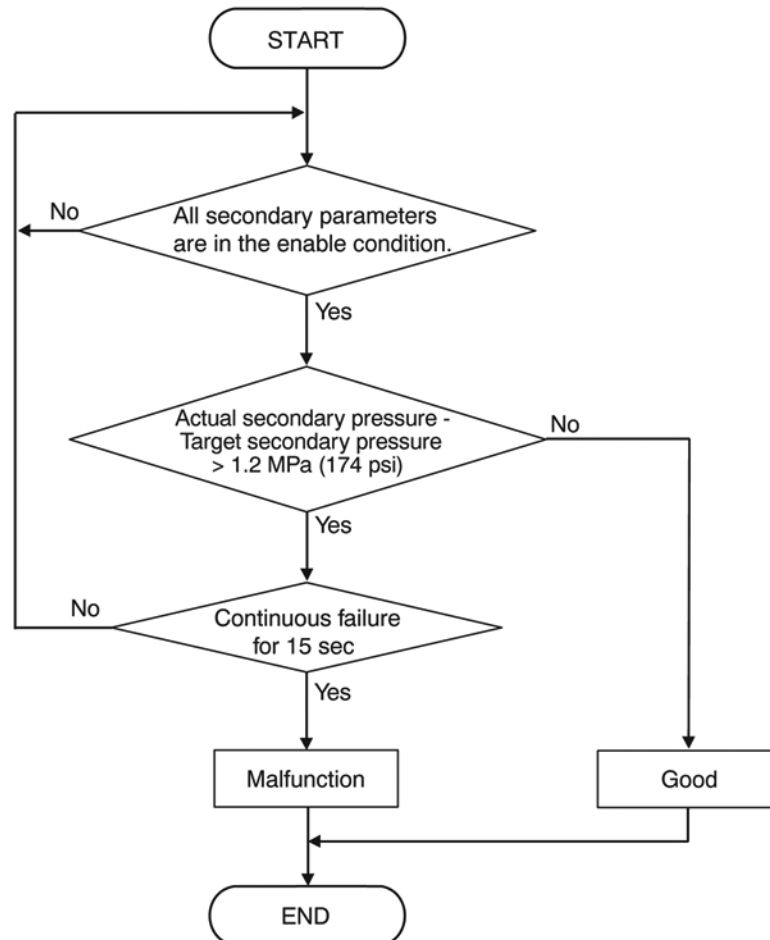

**CVT
 DIAGNOSTIC TROUBLE CODE PROCEDURES**

LOGIC FLOW CHARTS (Monitor Sequence–Output Functional Low)

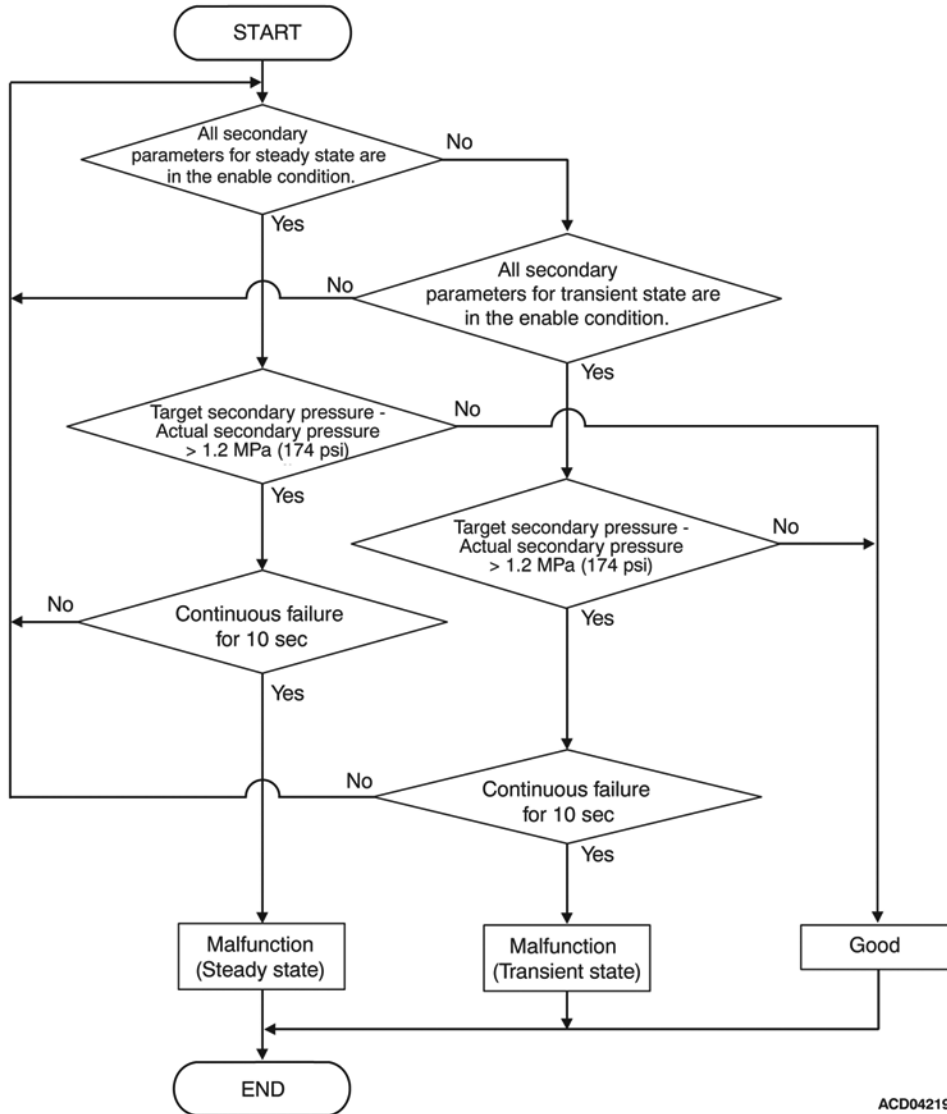

DTC SET CONDITIONS

Check Conditions <Output Functional High>

- Voltage of battery: 10 volts or more.
- Transmission range switch position: D or R.

Check Conditions <Output Functional Low (Steady state)>

- Voltage of battery: 10 volts or more.
- Transmission range switch position: D or R.
- Engine speed: 450 r/min or more.

- Target secondary pressure: 0 MPa (0 psi) or more.
- Time since following conditions are approved: More than 1.52 seconds. [2 times (Interval: 30 second)].
 - a. Target secondary pressure – Actual secondary pressure: 0.25 MPa (36 psi) or more.
 - b. Actual secondary pressure: Less than minimum line pressure.

CVT
DIAGNOSTIC TROUBLE CODE PROCEDURES

- c. Accelerator pedal position change rate:
6.25% / 1.52 seconds or less.
- d. Vehicle speed change rate: 15 km/h (9 mph) /
1.52 seconds or less.

Check Conditions <Output Functional Low (Transient state)>

- Voltage of battery: 10 volts or more.
- Transmission range switch position: D or R.
- Engine speed: 450 r/min or more.
- Target secondary pressure: 0 MPa (0 psi) or more.
- Time since following conditions are approved:
More than 1 seconds.
 - a. MIN [(Target secondary pressure – Actual secondary pressure), (Minimum line pressure – Actual secondary pressure)]: 2 MPa (290 psi) or more.

Judgment Criteria <Output Functional High>

- Actual secondary pressure – Target secondary pressure: More than 1.2 MPa (174 psi) (15 seconds).

Judgment Criteria <Output Functional Low (Steady state)>

- Target secondary pressure – Actual secondary pressure: More than 1.2 MPa (174 psi) (10 seconds).

Judgment Criteria <Output Functional Low (Transient state)>

- Target secondary pressure – Actual secondary pressure: More than 1.2 MPa (174 psi) (10 seconds).

OBD-II DRIVE CYCLE PATTERN

The vehicle is driven for at least 10 seconds with the accelerator opening angle at 20% or more.

PROBABLE CAUSES

- Malfunction of valve body assembly (Faulty secondary pressure solenoid valve)
- Malfunction of the CVT assembly

DIAGNOSIS

STEP 1. Scan tool (M.U.T.-III) DTC.

Q: Is diagnostic trouble code No. P0966 or P0967 set?

YES : Carry out the appropriate troubleshooting.

NO : Go to Step 2.

STEP 2. Measure the output wave pattern of the secondary pressure solenoid valve at TCM connector (SCLS terminal).

- (1) Connect the CVT assembly connector.
- (2) Selector lever position: L.
- (3) Drive at a constant speed of approx. 20 km/h (13 mph).
- (4) Connect an oscilloscope, and measure the voltage between TCM connector SCLS terminal and body ground.

OK: A wave pattern such as the one shown on (Check Procedure Using an Oscilloscope) should be output. There should be no noise in the output wave pattern.

Q: Is the check result normal?

YES : Go to Step 3.

NO : Refer to diagnostic trouble code No.P0966: Malfunction of Secondary Pressure Solenoid Valve (low input), or diagnostic trouble code No.P0967: Malfunction of Secondary Pressure Solenoid Valve (high input).

CVT
DIAGNOSTIC TROUBLE CODE PROCEDURES

STEP 3. CVT belt inspection

Use the bore scope to check the appearance (Slip marks, the presence or absence of damage) of the CVT belt. (Refer to Attached sheet 5)

Q: Is the CVT belt normal?

- YES** : Replace the valve body assembly. Then go to Step 4.
NO : Replace the CVT assembly.

STEP 4. Check whether the DTC is stored again

Erase the DTC.

Then, drive the vehicle for a while and check again.

Q: Is the diagnostic trouble code set?

- YES** : Replace the TCM.
NO : This diagnosis is complete.

DTC P084A: Abnormality in Primary Pressure Sensor Function

DIAGNOSTIC FUNCTION

The TCM determines that the system is defective when the primary pressure sensor output voltage is outside the predetermined value range.

DESCRIPTIONS OF MONITOR METHODS

All the conditions listed below remain for 5 seconds.

- The pulley ratio is 0.5 or more, 1.0 or less.
- The primary pulley speed is 300 r/min or more.
- The secondary pulley speed is 250 r/min or more.
- Target shifting speed is 0.1/sec or less.
- The primary pressure is outside the predetermined pressure range.

MONITOR EXECUTION

- Voltage of battery: 10 volts or more.

MONITOR EXECUTION CONDITIONS (OTHER MONITOR AND SENSOR)

Other Monitor (There is no temporary DTC stored in memory for the item monitored below)

- P0966, P0967: Malfunction of secondary pressure solenoid valve
- P0970, P0971: Malfunction of primary pressure solenoid valve

Sensor (The sensor below is determined to be normal)

- Not applicable

**CVT
 DIAGNOSTIC TROUBLE CODE PROCEDURES**

LOGIC FLOW CHARTS (Monitor Sequence)

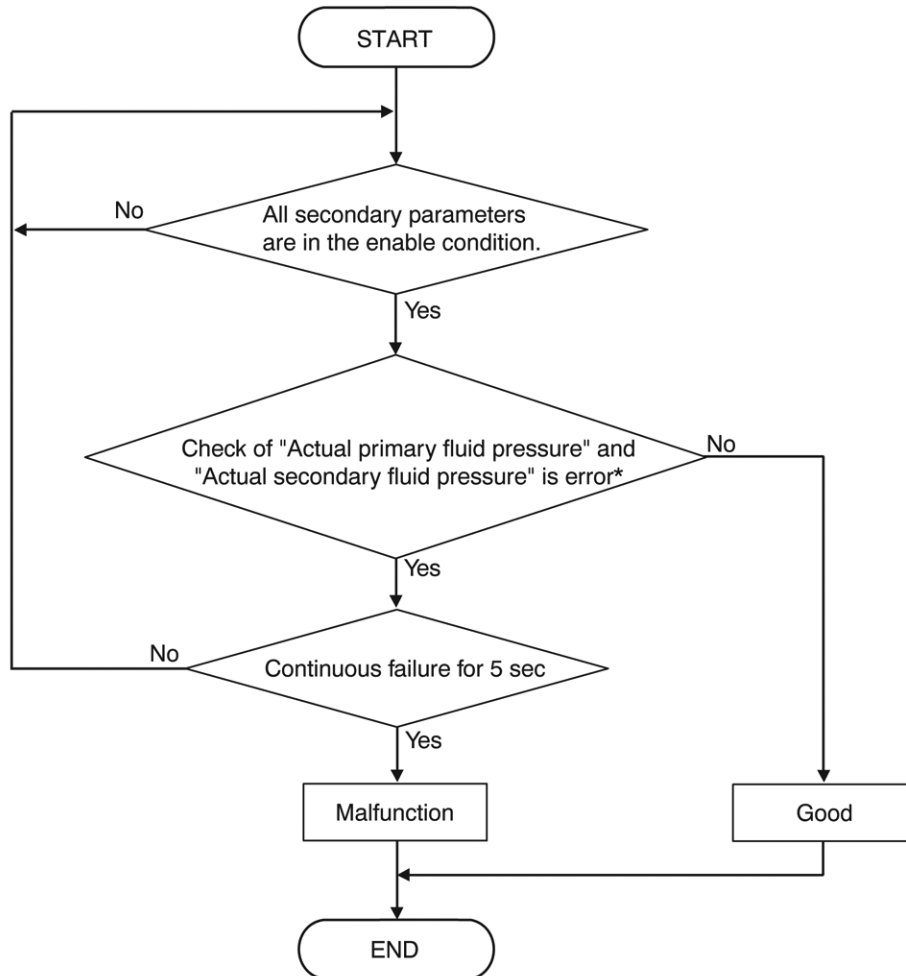

NOTE: *

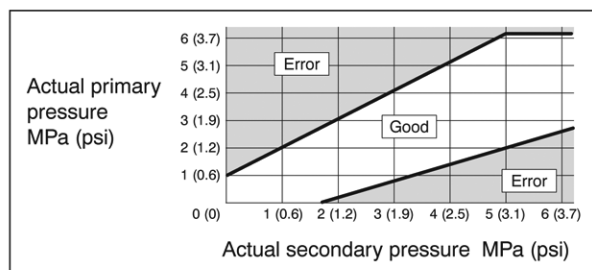

ACD04282

DTC SET CONDITIONS

Check Conditions

- Voltage of battery: 10 volts or more.
- Primary pulley speed: 300 r/min or more.
- Secondary pulley speed: 250 r/min or more.
- Pulley ratio: More than 0.5, less than 1.0.

Judgment Criteria

- Check of "Actual primary pressure" and "Actual secondary pressure" is error. (5 seconds)

OBD-II DRIVE CYCLE PATTERN

Ignition switch: ON (start the engine and keep it for 10 seconds or more)

**CVT
TROUBLE SYMPTOM DIAGNOSIS CHART**

PROBABLE CAUSES

- Malfunction of valve body assembly (Faulty primary pressure sensor, secondary pressure sensor)
- Damaged wiring harness and connectors
- Malfunction of the CVT assembly

DIAGNOSIS

STEP 1. Scan tool (M.U.T.-IIISE) DTC.

Q: Is diagnostic trouble code No. P0842, P0843, P0847 or P0848 set?

YES : Carry out the appropriate troubleshooting.

NO : Go to Step 2.

STEP 2. CVT belt inspection

Use the bore scope to check the appearance (Slip marks, the presence or absence of damage) of the CVT belt. (Refer to Attached sheet 5)

Q: Is the CVT belt normal?

YES : Replace the valve body assembly. Then go to Step 3.

NO : Replace the CVT assembly.

STEP 3. Check whether the DTC is stored again

Erase the DTC.

Then, drive the vehicle for a while and check again.

Q: Is the diagnostic trouble code set?

YES : Replace the TCM.

NO : This diagnosis is complete.

**CVT
 TROUBLE SYMPTOM DIAGNOSIS CHART**

TROUBLE SYMPTOM DIAGNOSIS CHART

M1231220500285

Diagnose the system by referring to the trouble symptom chart and the possible cause chart. Then check, repair or replace if necessary.

Trouble symptom chart

NOTE: Diagnose the system in the order of "Possible cause No."

Trouble symptom		Possible cause No.
Others	Malfunction of hesitation or poor acceleration	2 → 3 → 1 → 18

Possible cause chart

Possible cause No.	Probable cause	Remedy
1	Malfunction of the engine system	Check the engine system, and repair or replace if necessary.
2	Improper transmission fluid level	Check the transmission fluid, and repair or replace if necessary.
3	Not within the standard value of the line pressure	Check the hydraulic system, and repair or replace if necessary.
18	Malfunction of the CVT belt & pulley assembly	Visually inspection of CVT belt.

CVT
ON-VEHICLE SERVICE

ON-VEHICLE SERVICE

CVT BELT INSPECTION

M1231229800012

<Valve Body Removal>

1. Place the vehicle on a lift, put gear in "N".
2. Turn the ignition switch to the "LOCK" (OFF) position.
3. Disconnect negative (-) battery terminal.
4. Raise the vehicle. Make sure gear is in "N" prior to raising the vehicle.
5. Tie the right front tire and any vehicle member with a rope not to rotate the wheel.
6. Remove the drain plug from CVT oil pan and then drain CVT fluid.
7. Remove the oil pan bolts, and then oil pan and oil pan gasket. (Refer to GROUP 23A Oil pan and Valve body assembly)
8. Check CVT fluid condition and inside of the oil pan.
 - If large metal debris found, stop the incident CVT repair, re-install the removed oil pan and oil pan gasket with the removed oil pan bolts, and then replace with a new CVT assembly. (Refer to GROUP 23A Transaxle assembly)
 - Otherwise, follow next steps for the repair.
9. Remove the magnets from the oil pan, and then thoroughly wipe and clean the magnets.

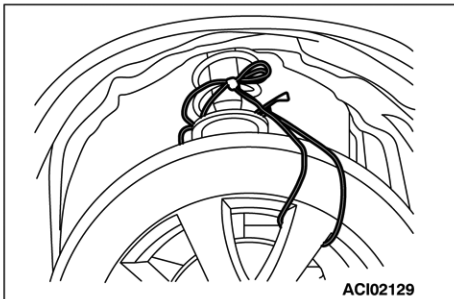

⚠ CAUTION

- No need to disconnect the CVT terminal body connector from the vehicle harness.
- Do not remove the snap ring from the CVT terminal body connector.
- Do not press the CVT terminal body connector into the CVT case.
- Valve body harness connector is different from CVT terminal connector and it needs to disconnect the valve body harness connector to remove the valve body from the CVT.

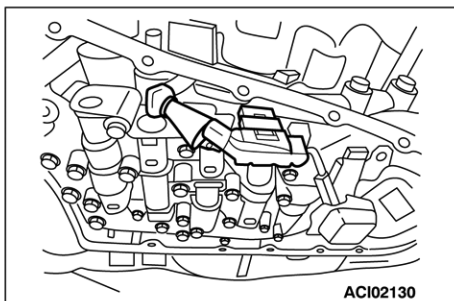

CVT
ON-VEHICLE SERVICE

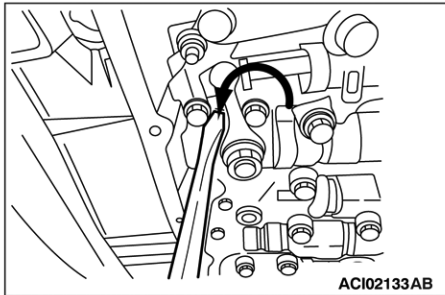

- Use a flat head screwdriver to prevent manual plate shifting out of "N" position while removing the manual plate fixing nut as shown below figures.

10. Remove the valve body assembly. (Refer to GROUP 23A Oil pan and Valve body assembly)
After valve body removal, leave the vehicle rose up on the lift for 30 minutes to drain CVT fluid residue.

<Belt Visual Inspection>

CAUTION

- Slowly rotate the front left tire entire one round to rotate the belt to inspect all around of the belt flanks surfaces.
- Rotate the tire as slow as each belt element flank can be carefully inspected if any evidence of damage presented or not, or pose the rotation periodically such as every 9 – 10 elements movement on a camera view, and inspect, and then move to next 9 – 10 elements to inspect.
- The aim is performing inspection to each belt element flank if damaged or not.
- Make a mark on a side wall of the tire to recognize one round of rotation.
- Rotate the tire in the forward rotation only. If the tire is rotated in the backward rotation, the bore scope camera lens may get caught between the belt and pulley.
- Make sure the front right tire is fixed by a rope not to rotate.
- Clean so that foreign matter does not adhere to the insertion portion of the bore scope camera.
- Make sure the 90 degree viewing mirror is securely attached.

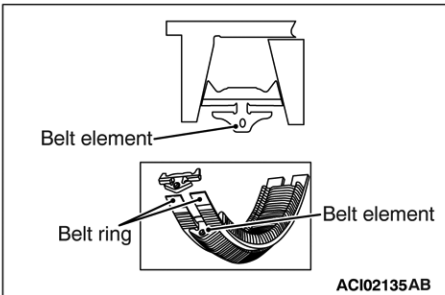

Visually inspect all around of the both pulley mating surfaces of the belt (flanks surfaces of belt elements) using a bore scope camera with a 90 degree viewing mirror.

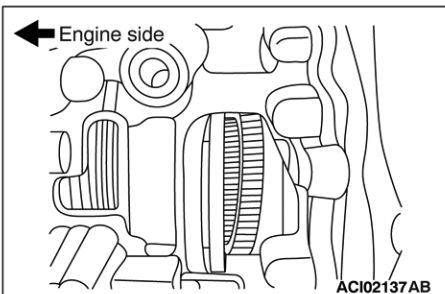
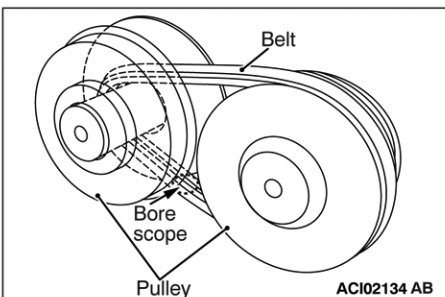
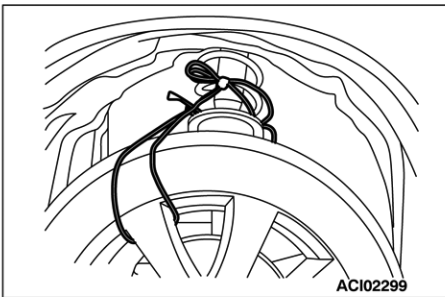

1. Inspect the near engine side - vehicle right side of flanks surfaces of the belt.
 - (1) Straighten the cable and face the scope towards side of the primary pulley.

CVT ON-VEHICLE SERVICE

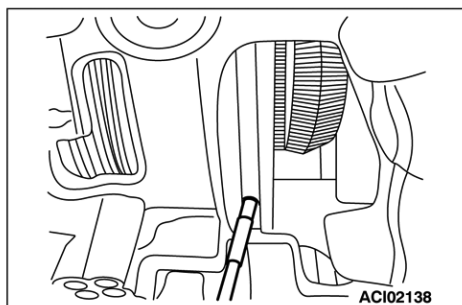

- (2) Enter the scope in between rear of the primary pulley and CVT case.

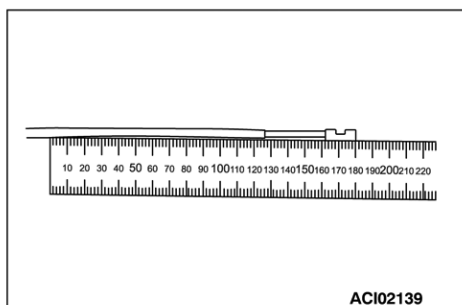

- (3) Feed the cable straight in about 180 mm (7 inches) until a side of the belt appears in the camera screen. (Past pulley.)

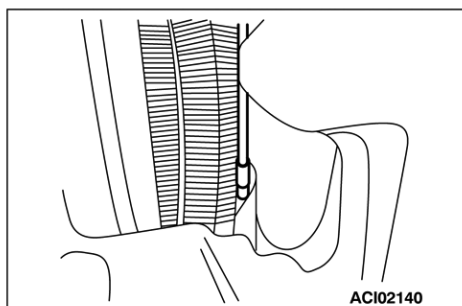

2. If the inspection result is OK, inspect the other side - near CVT side cover side - vehicle left side of flanks surfaces of the belt.

CAUTION

Refer to below damage sample illustrations.

- If damage is found on either side of mating surfaces of the belt, CVT assembly replacement is required.
- If no damage is found on mating surfaces of the belt, a new valve body installation is required. Follow next steps.

NOTE: Be sure to replace the filter screen and external filter element. Refer to ASA CAPS for correct part numbers for the vehicle.

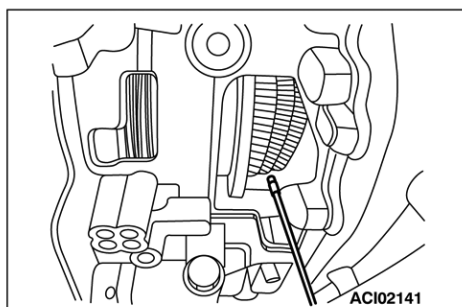

CVT
ON-VEHICLE SERVICE

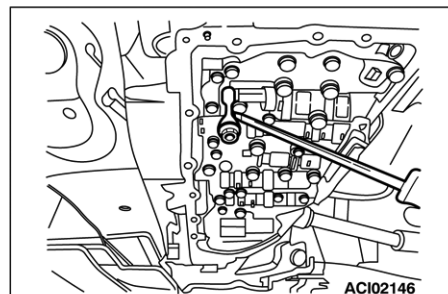
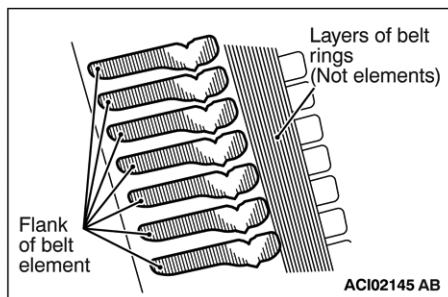
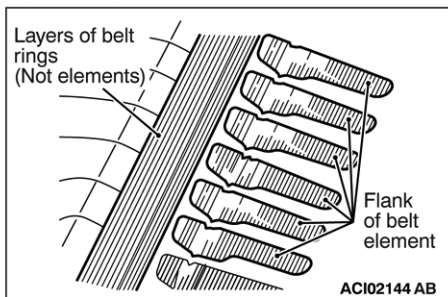
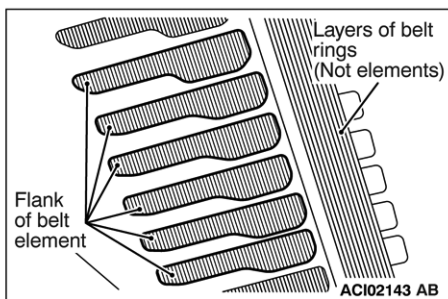
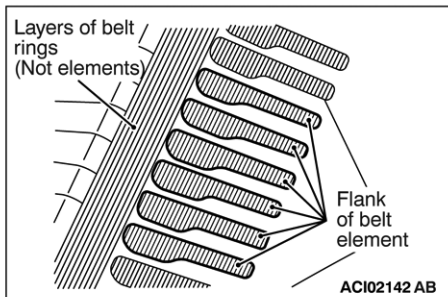

<OK SAMPLES>

- No damage is observed on flanks (grooved surfaces) of belt elements.

< DAMAGE SAMPLES >

- Damages to grooves are observed on flanks of belt elements.

<New Valve Body Installation>

CAUTION

Place a flat head screwdriver as shown below figures while installing the manual plate to the valve body with the nut. It prevents damages to the manual valve spool. Do not pry the screwdriver. Shifting out from the "N" position is acceptable after the belt visual inspection.

1. Install the new valve body assembly.
(Refer to GROUP 23A Oil Pan and Valve Body assembly.)

**CVT
ON-VEHICLE SERVICE**

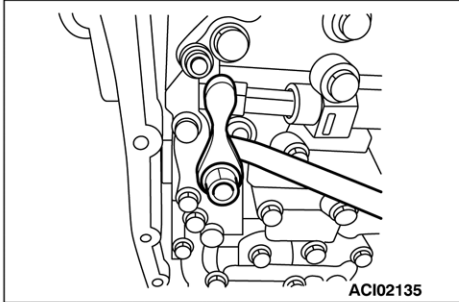

CAUTION

The magnets and the oil pan must be thoroughly cleaned.

2. Place the magnets on the oil pan.

CAUTION

Do not re-use the old oil pan gasket.

3. Install an oil pan gasket and the oil pan.

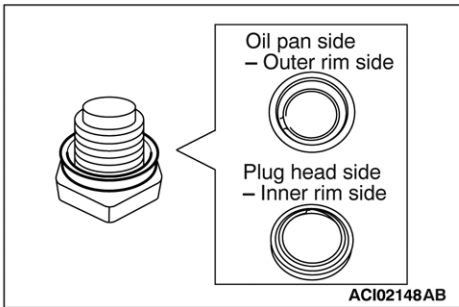

CAUTION

- Do not re-use the drain washer. Use a new one.
- Drain washer has two sides. Refer to below figures.
- **Replace the oil strainer and transmission fluid filter, circled in diagram below.**

4. Place a drain plug washer on the drain plug, and then install the drain plug with washer.

Tightening torque: 33 ± 1 N·m (24 ± 0.4 ft·lb)

5. Connect the battery negative terminal.

6. Remove the rope which tying the front right tire and vehicle member.

CAUTION

Make sure no fluid leak.

7. Fill CVT fluid into CVT assembly.

8. Perform TCM initialization.

(Refer to GROUP 23A Initialization Procedure for CVT Learned Value)

9. Perform TCM Learning Procedure.

(Refer to GROUP 23A Learning Procedure)

10. Test drive the vehicle.

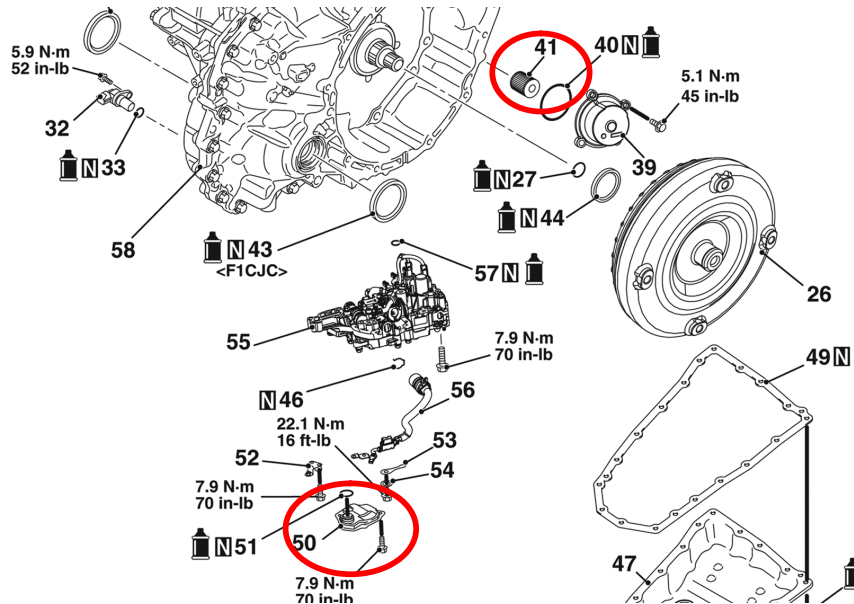

PARTS INFORMATION

Use the genuine Mitsubishi Parts listed below:

NOTE: ONLY order a new CVT-8 transmission after following instructions in the Repair Procedure in this TSB.

Description	Model	Part Number		Quantity
CVT-8 Transmission Assembly	2016 Lancer (4B11)	2WD	2700A401	1
		4WD	2700A403	1
	2016 Lancer (4B12)	2WD	2700A435	1
		4WD	2700A406	1
	2016 Outlander (4J12)	2WD	2700A435	1
		4WD	2700A406	1
	2015 Outlander Sport/RVR (4B11)	2WD	2700A401	1
		4WD	2700A403	1
Transmission Fluid: Mitsubishi Motors Genuine CVTF-J4	All	MZ320185		6.9 L (7.3 qt)

NOTE: ONLY order a new valve body or CVT-8 transmission after following instructions in the Repair Procedure in this TSB.

Model	Vehicle Drive	Control Valve Part Number	CVT-8 Transmission Part Number	Quantity	
2018-2020 Eclipse Cross (4B40)	2WD	2800A187	2700A451	1	
	4WD		2700A453	1	
2016-2017 Lancer (4B11)	2WD		2700A401	1	
	4WD		2700A403	1	
2016-2017 Lancer (4B12)	2WD		2700A435	1	
	4WD		2700A406	1	
2016-2020 Outlander (4J12)	2WD		2700A435	1	
	4WD		2700A406	1	
2015-2020 Outlander Sport/RVR (4B11)	2WD		2700A401	1	
	4WD		2700A403	1	
2018-2020 Outlander Sport/RVR (4B12)	2WD		2700A401	1	
	4WD		2700A403	1	
All			MZ320185	Transmission Fluid: Mitsubishi Motors Genuine CVTF-J4	6.9 L (7.3 qt)

WARRANTY INFORMATION**REPROGRAMMING OF CVT-8 TRANSMISSION:**

Look up the vehicle's VIN in the Warranty Superscreen. Check if any of the following campaigns are showing as open on the Superscreen:

- C1606Z
- C1607Z
- C1512Z
- C1513R
- C1514R (Canada)

If any of these campaigns are NOT completed, complete SR-16-006 ONLY, following instructions in that bulletin to enter the proper claims for the vehicle.

TEST DRIVE AND REPLACEMENT OF CVT-8 TRANSMISSION:

Operation	Nature Code	Cause Code	Country of Origin	Model	Labor Operation	Vehicle Drive	Time Allowance
Test Drive Only (no replacement needed)	05A	440	USA, Canada, Puerto Rico	All	233010TD	All	0.3 hrs
Replace CVT-8 Assembly + includes Test Drive	05A	440	USA	Lancer	233010R1	2WD	5.5 hrs
				Lancer AWC		4WD	6.4 hrs
			Canada	Lancer	233010R2	2WD	5.8 hrs
				Lancer AWC		4WD	6.7 hrs
			USA, Puerto Rico	Outlander	233010R3	2WD	6.5 hrs
					233010R4	4WD w/out S-AWC*	7.1 hrs
					233010R5	4WD w/S-AWC*	8.5 hrs
					233010R6	2WD	7.0 hrs
			Canada	Outlander	233010R7	4WD w/out S-AWC*	7.6 hrs
					233010R8	4WD w/S-AWC*	9.0 hrs
			USA, Puerto Rico	Outlander Sport	233010R9	2WD	6.5 hrs
					233010R0	4WD	7.6 hrs
			Canada	RVR	233010R9	2WD	6.8 hrs
					233010R0	4WD	7.9 hrs

* Please check the "Monroney" listing to verify if a 4WD/AWD vehicle has Super All Wheel Control (S-AWC). The "Monroney" can be found on the Warranty Superscreen for the specific VIN.

Factory and POE Installed Equipment	
10B GD1 GL1 GM1 G21 G81 HC1	
View Vehicle Monroney	
Dealer Installed Options	

CVT-8 BELT INSPECTION & VALVE BODY REPLACEMENT/REINSTALLATION:

Operation	Nature Code	Cause Code	Country of Origin	Model	Labor Operation	Vehicle Drive	Time Allowance
CVT Belt Inspection and Valve Body Replace/Reinstall	24F	830	USA	Eclipse Cross	233810YM	All	2.9 hrs
				Lancer			3.1 hrs
				Outlander			2.9 hrs
				Outlander Sport			2.9 hrs

Warranty Coverage: Powertrain coverage

- 10/100 if Original owner
- 5/60 if Subsequent owner