



SERVICE BULLETIN

Classification: AT20-002a	Reference: NTB20-036a	Date: June 25, 2020
------------------------------	--------------------------	------------------------

2018-2019 VERSA SEDAN AND VERSA NOTE; CVT JUDDER

This bulletin has been amended. See **AMENDMENT HISTORY** on the last page.
Please discard previous versions of this bulletin.

APPLIED VEHICLES: 2018-2019 Versa Sedan (N17)
2018-2019 Versa Note (E12)

APPLIED TRANSMISSION: CVT (RE0F11A)

IF YOU CONFIRM

The customer reports a transmission judder (shake, shudder, single or multiple bumps or vibration), hesitation on acceleration, lack of power or RPM flare.

ACTION

Refer to the **Repair Overview** on pages 2 and 3.

IMPORTANT: The purpose of **ACTION** (above) is to give you a quick idea of the work you will be performing. You **MUST** closely follow the entire **SERVICE PROCEDURE** as it contains information that is essential to successfully complete this repair.

Nissan Bulletins are intended for use by qualified technicians, not 'do-it-yourselfers'. Qualified technicians are properly trained individuals who have the equipment, tools, safety instruction, and know-how to do a job properly and safely. **NOTE:** If you believe that a described condition may apply to a particular vehicle, **DO NOT** assume that it does. See your Nissan dealer to determine if this applies to your vehicle.

REPAIR OVERVIEW

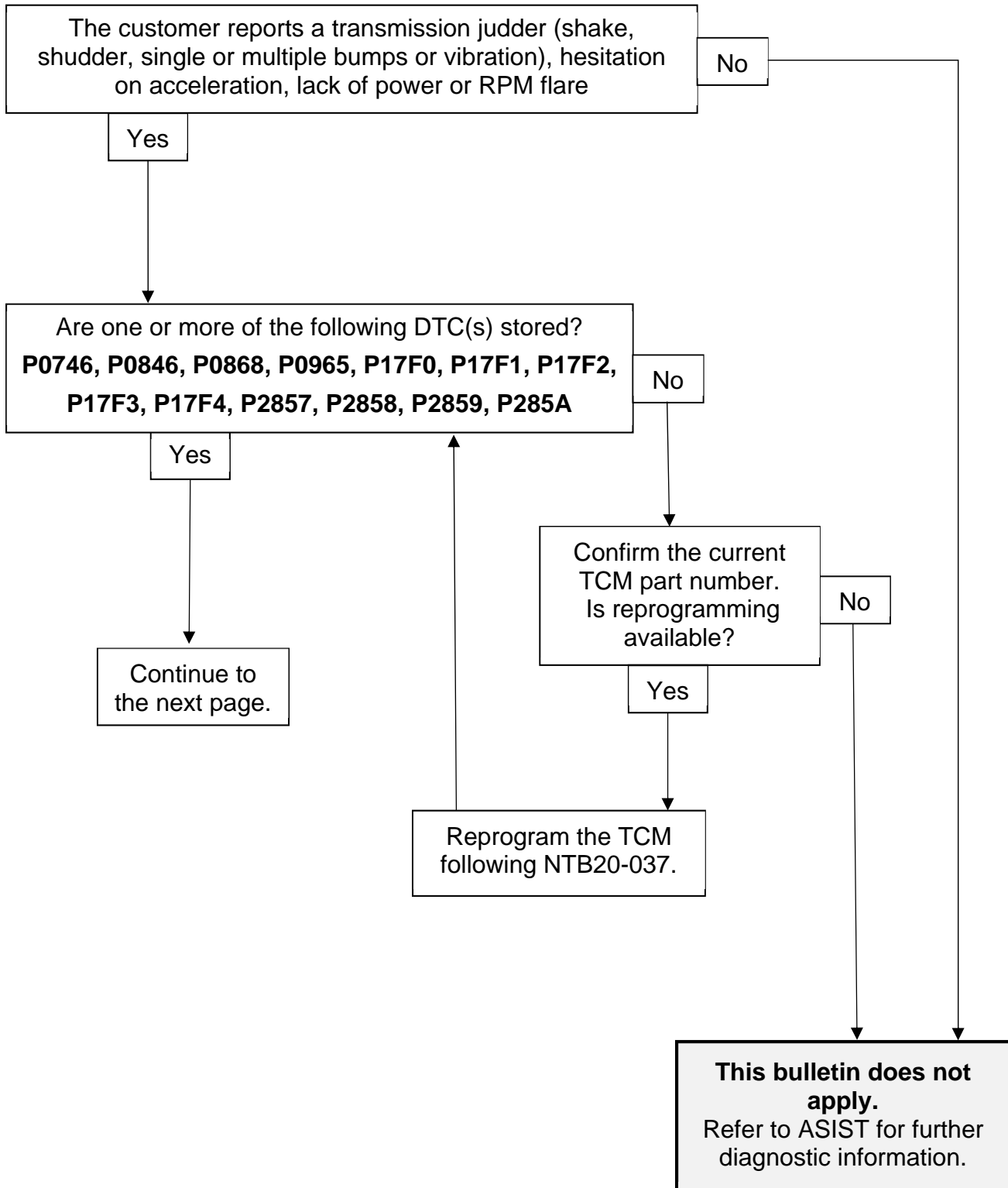

Continued on the next page

Repair Overview (continued)

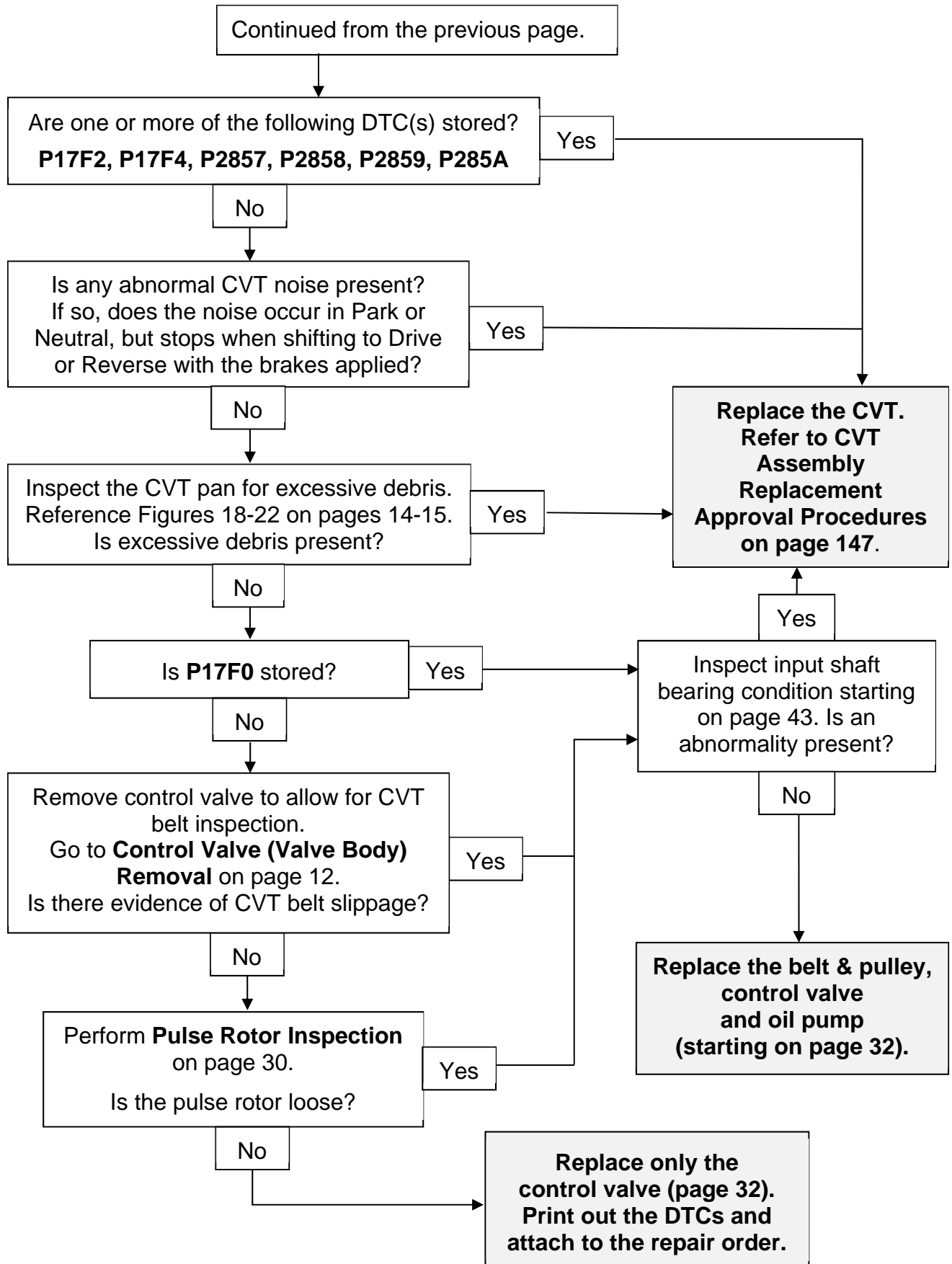

Table of Contents

• Required Tools / Material.....	page 6
• Essential Special Service Tools.....	page 6
• Weights.....	page 9
• Precautions when Disassembling a CVT Assembly.....	page 10
• Inspection for Abnormal Noise.....	page 11
• Control Valve (Valve Body) Removal.....	page 12
• CVT Belt Visual Inspection.....	page 18
• Pulse Rotor Inspection.....	page 30
• No Belt Damage/Pulse Rotor Not Loose – Replace Control Valve.....	page 32
• Belt Damaged Or Pulse Rotor Loose.....	page 33
• Remove CVT from Vehicle and Disassemble External Parts.....	page 33
• Remove the Fluid Filter.....	page 35
• Remove the Oil Pan and Torque Converter Housing.....	page 37
• Remove the Oil Seals from the Torque Converter Housing.....	page 38
• Remove the CVT Internal Components.....	page 39
• Remove the Sub-assembly.....	page 50
• Clean the CVT Surfaces.....	page 56
• Clean the Oil Passages in the CVT Case and Oil Pump Cover.....	page 57
• Measuring the CVT Sub-assembly Case Depth.....	page 63
• New Snap Ring Selection and Installation to the New Sub-assembly.....	page 66
• Install Sub-assembly to CVT Case.....	page 72
• Install the Oil Pump and the Manual Shaft.....	page 77
• Install Powertrain Parts.....	page 80
• Install the Torque Converter Housing.....	page 88
• Install the Control Valve and Oil Pan.....	page 91
• Seal the Sub-assembly Cover.....	page 94

Table of Contents (continued)

- Install and Adjust the Transmission Range Switch..... page 99
- Install Exterior CVT Parts..... page 100
- Install the CVT Assembly..... page 105
- Additional Service When Replacing Control Valve or Transaxle Assembly page 106
- TCM Reprogramming..... page 107
- TCM Recovery..... page 126
- Control Valve Replacement..... page 127
- Erase Learning Value..... page 132
- Conform CVTF Deterioration..... page 134
- Auxiliary Gearbox Clutchpoint Learning..... page 137
- PARTS INFORMATION..... page 140
- CLAIMS INFORMATION..... page 143
- KIT PARTS REFERENCE TABLE..... page 145
- CVT Assembly Replacement Approval Procedures..... page 148
- AMENDMENT HISTORY..... page 148

REQUIRED TOOLS / MATERIALS

- Petroleum jelly or equivalent
- Extendable magnet
- Large clean surface / 1 to 2 work tables
- Brake cleaner
- Rubbing alcohol
- Plastic scraper
- Mallet
- Sandpaper

Essential Special Service Tools

Additional Essential Tools are available from Tech•Mate online: www.nissantechmate.com or by phone: 1-800-662-2001.

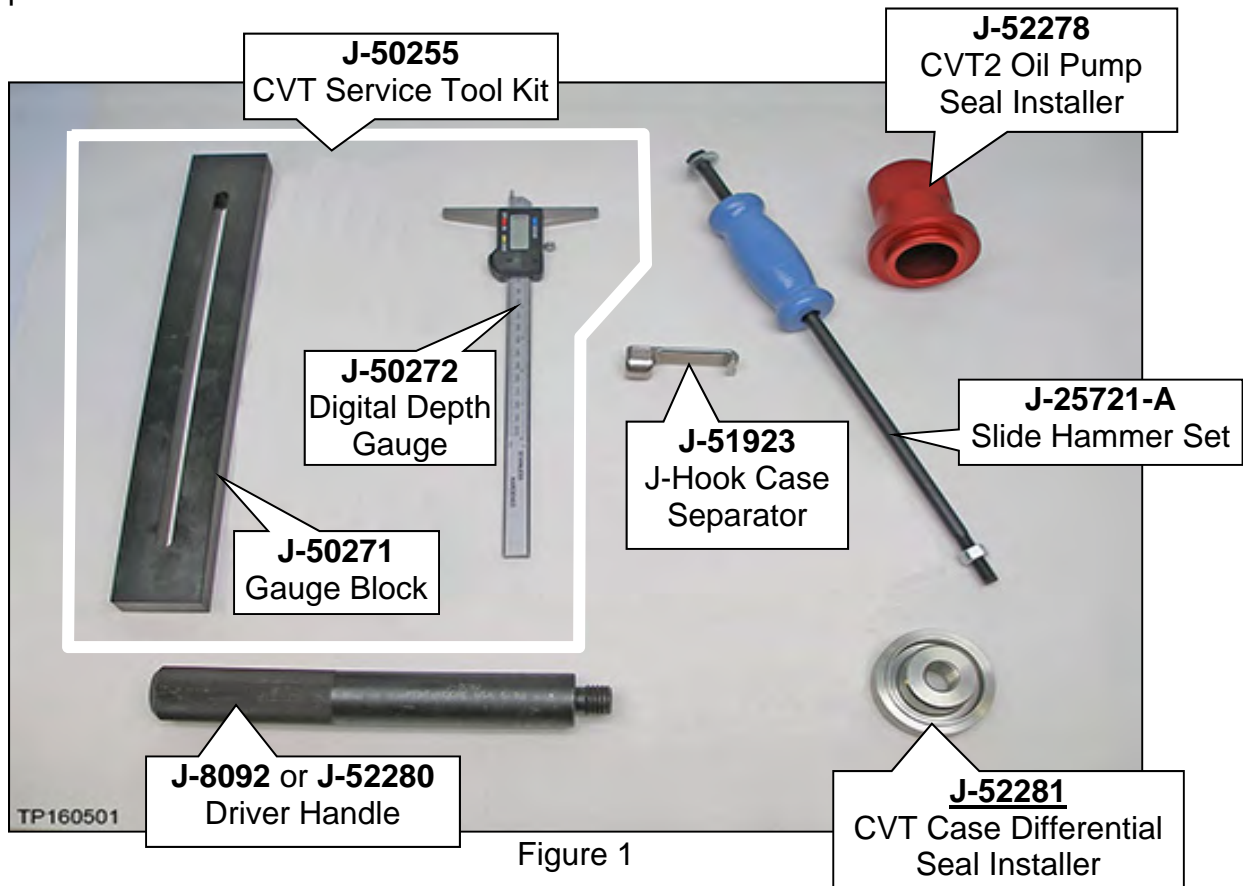

Essential Special Service Tools (continued)

Tech Cam J-51951

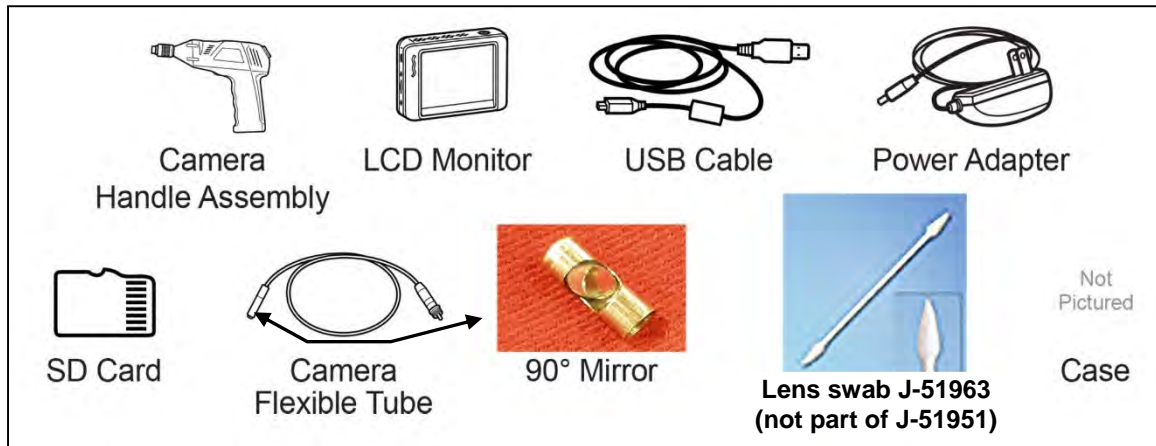

Figure 3

J-52306-1 and J-52306-2
Transmission Range Switch
Alignment Bracket and Pin



Figure 4

J-52273 Clutch
Engagement Tool

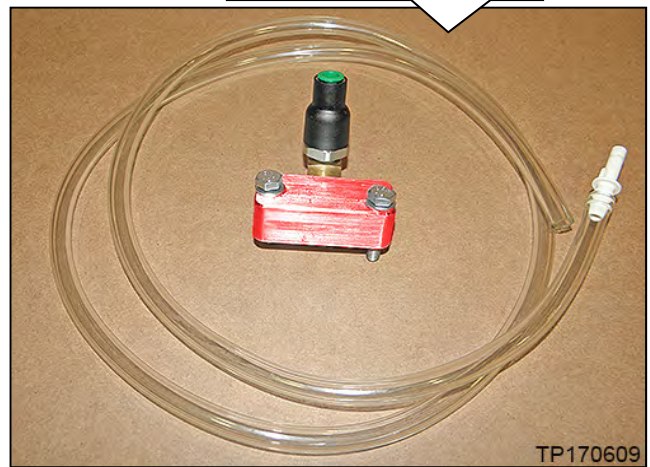

Figure 5

J-42909 Evap
Pressure Test Kit

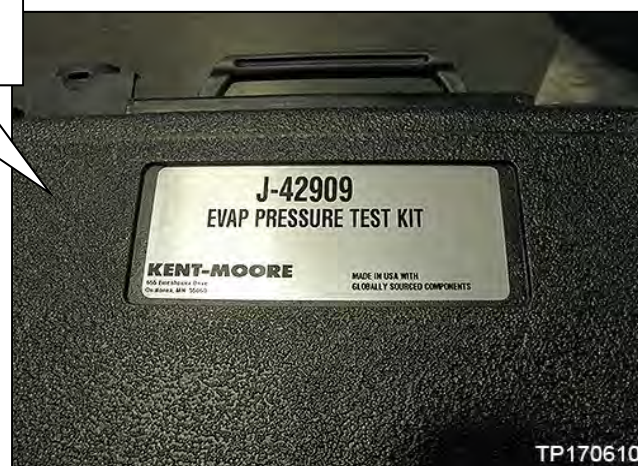

Figure 6

Essential Special Service Tools (continued)

- Split Ring Seal Installer Kit **J-52595**

J-52595-3
Seal Driver



Figure 7

J-52595-4
Split Ring Seal Cover



Figure 8

J-52595-1
First Groove Seal Tool (Top)



Figure 9

J-52595-1
First Groove Seal Tool (Bottom)



Figure 10

J-52595-2
Second Groove Seal Tool (Top)



Figure 11

J-52595-2
Second Groove Seal Tool (Bottom)



Figure 12

Essential Special Service Tools (continued)



Figure 13



Figure 14

Weights

- CVT assembly: 150 lbs. approximately
- CVT sub-assembly: 40 lbs. approximately

SERVICE PROCEDURE

IMPORTANT: Repairs performed for this bulletin require CONSULT-III plus (C-III plus) **Diagnostic result reporting function-Setting** be turned ON and **Diagnosis (All Systems)** be performed. If not done, it may result in a repair being non-warrantable.

Precautions when Disassembling a CVT Assembly

IMPORTANT:

Transmissions are vulnerable to particle contamination (dust, metal, lint, etc.).

When disassembling a CVT, make sure your work environment (shop, workbench, etc.), transmission area (sub-frame, oil pan, harness connector, etc.), and your hands are free of any contamination.

It is essential that any foreign contamination be kept out of the CVT internals. Disassembly and re-assembly shall be carried out under the following conditions:

NOTICE

To prevent possible drivability concerns, cover all air breather and drive shaft holes to prevent water intrusion.

- Wash and clean the exterior of the CVT assembly prior to disassembling.
- Work in a covered indoor room to prevent contamination of the CVT.
- Work on clean stainless drain table.
- Avoid debris from dropping into the converter housing, side cover or CVT case.
- Remove any sealant remaining on bolts or mating surfaces of the converter housing, side cover and/or the CVT case using a scraper, and then clean with lint-free paper cloths.
- Store removed parts separately to prevent mix-up. (i.e. small cups)
- Do not use cotton gloves or woven cloths. Latex or rubber gloves are recommended.
 - Only lint-free paper cloths.
- Apply rust penetrant to locator / dowel pins on torque converter housing and side cover of CVT and allow to soak as needed.
- Only disassemble those parts which are mentioned in this bulletin.
- Make sure all parts are clean prior to assembling / installing.
 - Brake cleaner is acceptable to remove remaining CVT fluid and residual sealer.
 - Unpack service parts just before installation.
- Use only specified sealant material.

- Store the related parts that have been removed separately to prevent being mixed up; small cups can be used.

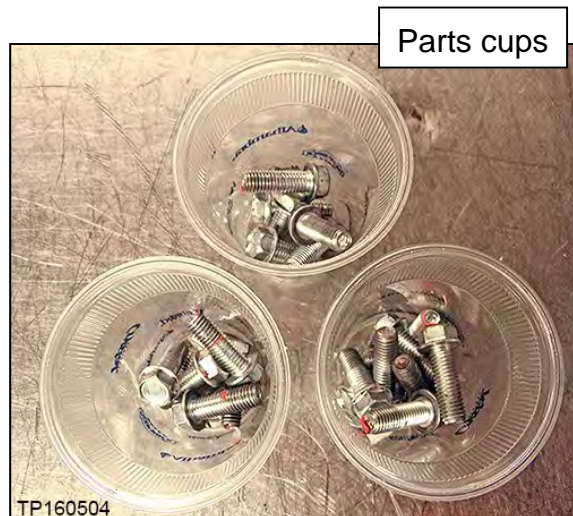

Figure 15

NOTICE Non-warrantable damage to the CVT may occur if the steps in this procedure are not followed in order.

Inspection for Abnormal Noise

HINT: If DTCs are stored, abnormal noise may be present.

Listen for any abnormal CVT noises under the following conditions:

Set the parking brake, and start the engine.

- If an abnormal CVT noise stops once the CVT is shifted into drive or reverse, this bulletin does not apply.
 - Refer to ASIST for further diagnostic information.
- If an abnormal CVT noise occurs while the CVT is in Drive (D) or Reverse (R), proceed to **Control Valve (Valve Body) Removal** on the next page.

Control Valve (Valve Body) Removal

NOTICE

- To avoid damage to the CVT, never allow any chemicals or fluids other than NS-3 CVT fluid or suitable cleaners to enter the CVT assembly.
- To avoid damage to the CVT, never allow any foreign debris, dust, dirt, etc. to enter the CVT assembly.

1. Write down all audio presets.

Presets	1	2	3	4	5	6
AM						
FM 1						
FM 2						
SAT 1						
SAT 2/3						
Bass	Treble	Balance	Fade	Speed Sen. Vol.		

2. Place the vehicle on a lift.

3. Before lifting the vehicle, place the transmission gear selector in Neutral.

4. Disconnect both battery cables, negative cable first.

5. Raise the vehicle, and then drain the CVT fluid by removing the drain plug.

- Remove the engine under cover if needed.

CAUTION To avoid the risk of minor personal injury, use caution when looking into the drain hole as there is the risk of fluid entering the eye.

6. Disconnect the engine room harness from the CVT.

7. Remove the oil pan mounting bolts, and then remove the oil pan and oil pan gasket.

- Do not discard the bolts. These will be reused during assembly.



Figure 16

Exploded View

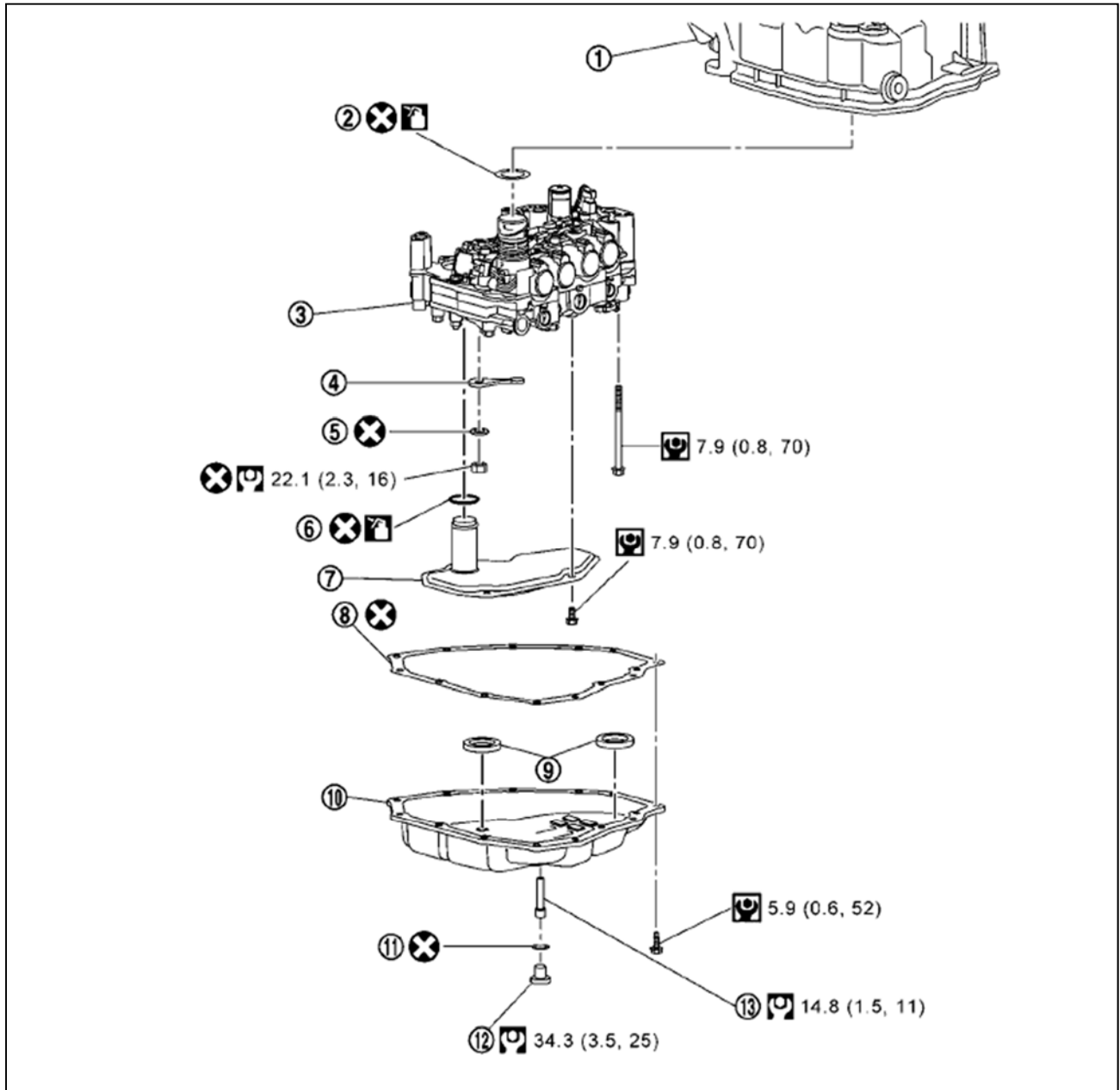





Figure 17

- 1. Transaxle assembly
- 4. Manual plate
- 7. Strainer
- 10. Oil pan
- 13. Overflow tube

- 2. O-ring
- 5. Washer
- 8. Oil pan gasket
- 11. Drain plug gasket

- 3. Control valve
- 6. O-ring
- 9. Magnet
- 12. Drain plug

-  : Always replace after every disassembly.
-  : N•m (kg-m, ft-lb)
-  : N•m (kg-m, in-lb)

8. Inspect the inside of the CVT pan for any evidence of broken parts.

EXAMPLE:

- Figure 18 and Figure 19 **are acceptable for this repair** – Magnets with fine debris or sludge in any amount.

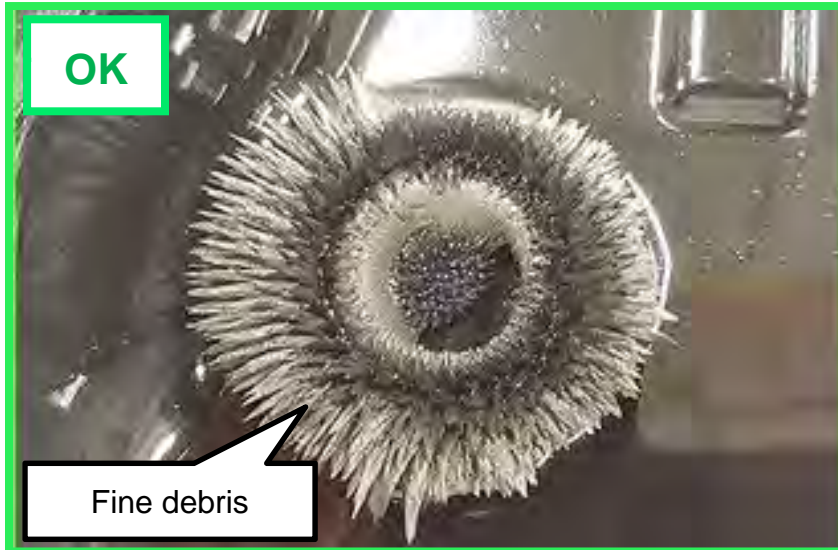

Figure 18

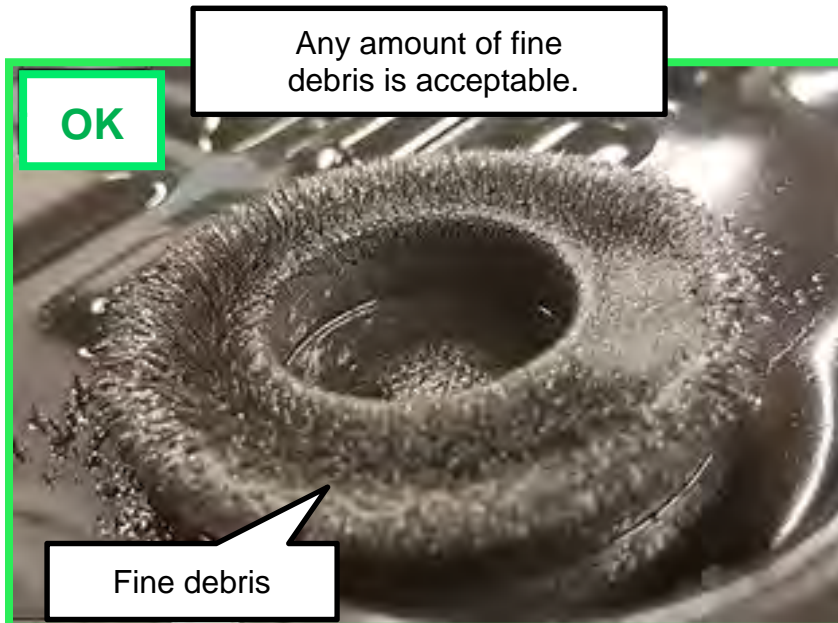

Figure 19

Continue to the next page.

- Figure 20, Figure 21 and Figure 22 are **No Good (NG)** for this repair - Broken parts would include pieces of bearings, clutch material, belt elements, etc.



Figure 20

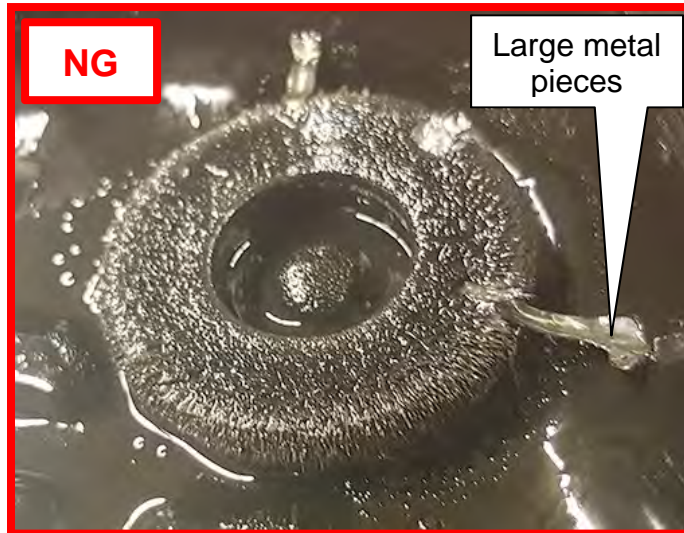

Figure 21



Figure 22

Continue to the next page.

Is there any evidence of broken parts or excessive debris?

- **YES:** Replace the CVT assembly as follows:
 - a. Document the debris found with a video (see page 148 for details).
 - b. Re-install the CVT oil pan gasket and oil pan.
 - c. Call the PCC for CVT replacement authorization (see page 148 for contact information).
 - d. Refer to the Electronic Service Manual (ESM), section **TRANSMISSION & DRIVELINE > TRANSAXLE & TRANSMISSION > CVT: RE0F11A > UNIT REMOVAL AND INSTALLATION** for CVT replacement.
- **NO:**
 - If DTC P17F0 is not stored, proceed to next step to continue the repair.
 - If DTC P17F0 is stored, proceed to **Remove CVT from the Vehicle and Disassemble External Parts** on page 33.

9. Remove the magnets from the oil pan.

HINT: The CVT pan may come with two (2) or three (3) magnets.

- Clean the magnets.
- Clean the CVT oil pan.
- Reinstall the magnets to the oil pan in their original positions.

10. Remove the three (3) oil strainer bolts, and then remove the oil strainer from the control valve.

- These bolts will be reused.

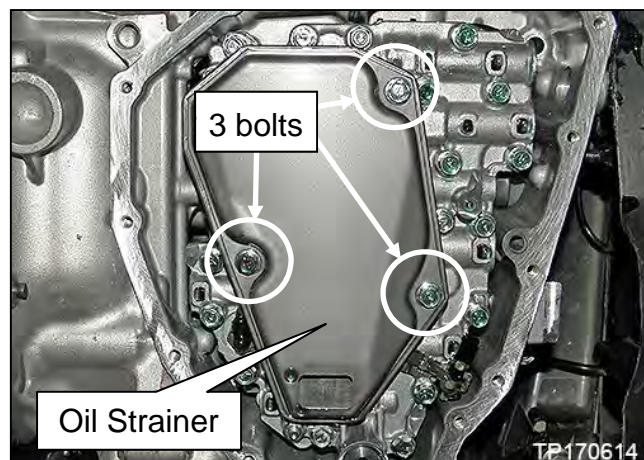

Figure 23

11. Remove the nut and washer, and then remove the manual plate shown in Figure 24.

- Use a screwdriver to hold the manual plate (Figure 25) to keep the shaft from rotating while removing the nut.
- Do not discard the nut and washer. These will be reused during assembly.

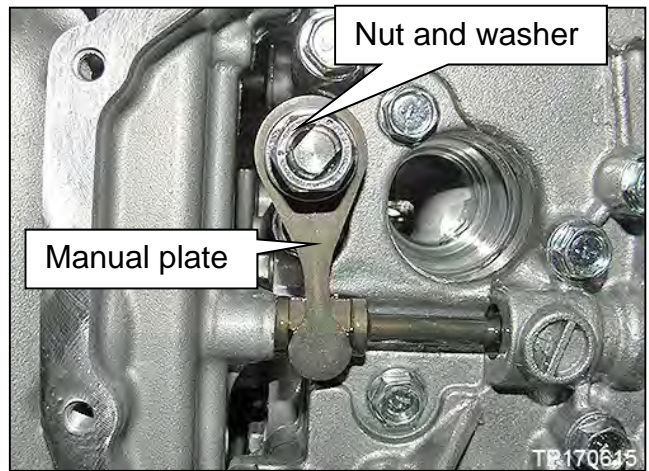

Figure 24

12. Clean around the CVT unit harness connector to prevent foreign materials from entering into the CVT case (picture not shown).

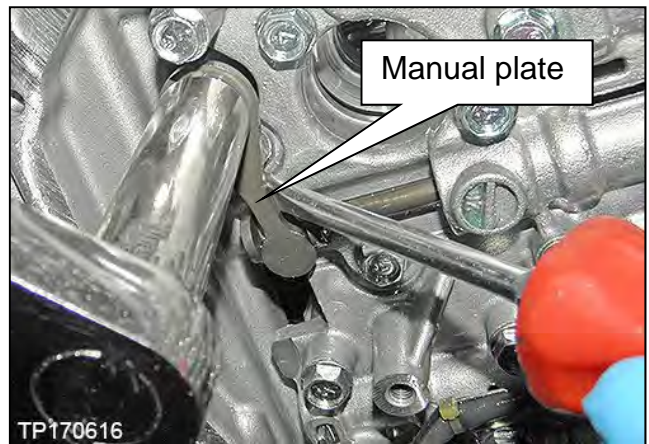

Figure 25

13. Remove ONLY the eleven (11) control valve bolts circled in yellow with markings as shown in Figure 26.

- On this model transaxle, Do NOT remove the bolts with a single dot over the "7" (not shown).
- The bolts removed will be reused.

14. Press the CVT unit harness connector down, into the transaxle case, and then remove the control valve from the transaxle case.

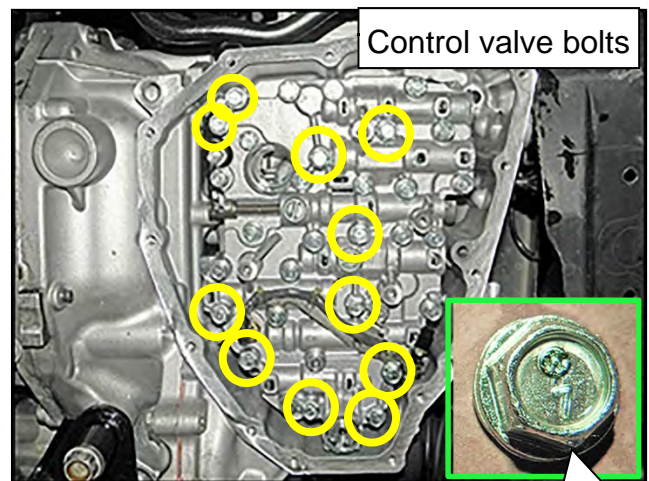

Figure 26

NOTICE Transaxle damage may occur if care is not taken when handling the CVT unit harness connector.

CVT Belt Visual Inspection

15. Secure the passenger side (RH) front wheel with a suitable strap.
 - a. Connect the first hook of the strap to the coil spring as shown in Figure 27.
 - b. Route the strap around the center of the tire and attach the second hook through the eyelet of the first hook that is attached to the coil spring.
 - c. Tighten the strap sufficiently to keep the passenger side (RH) front tire from rotating but do not overtighten.
 - d. This will assist in making the belt turn during the borescope belt inspection step.

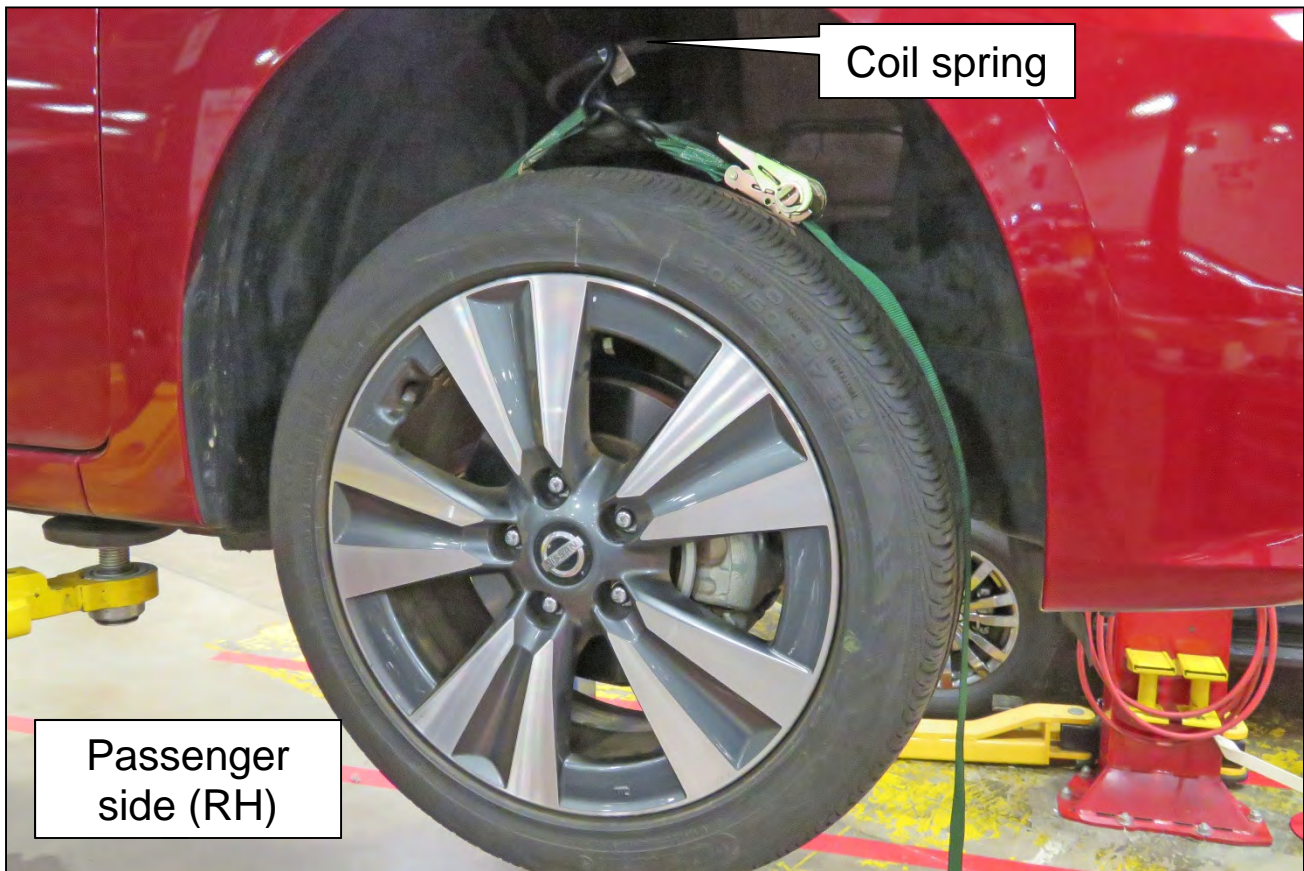

Figure 27

16. Mark the driver side (LH) front wheel with a suitable marking.
 - This will ensure all 360° of the belt are inspected.

17. Inspect the entirety of the two sides of the belt that come in contact with the pulleys (Figure 28).

IMPORTANT:

- Reference Figure 40 through Figure 48 on pages 26 - 29 for comparison.
- Use borescope J-51951 with mirror attachment.
- Be sure to remove the protective film from the mirror before the first use.
- Clean the camera lens and mirror before each inspection. Use 90% isopropyl alcohol, and a lens swab from Lens Swab packet J-51963 listed in **PARTS INFORMATION** on page 140.
- Before inspecting, make sure the batteries in the camera handle and LCD monitor are charged.

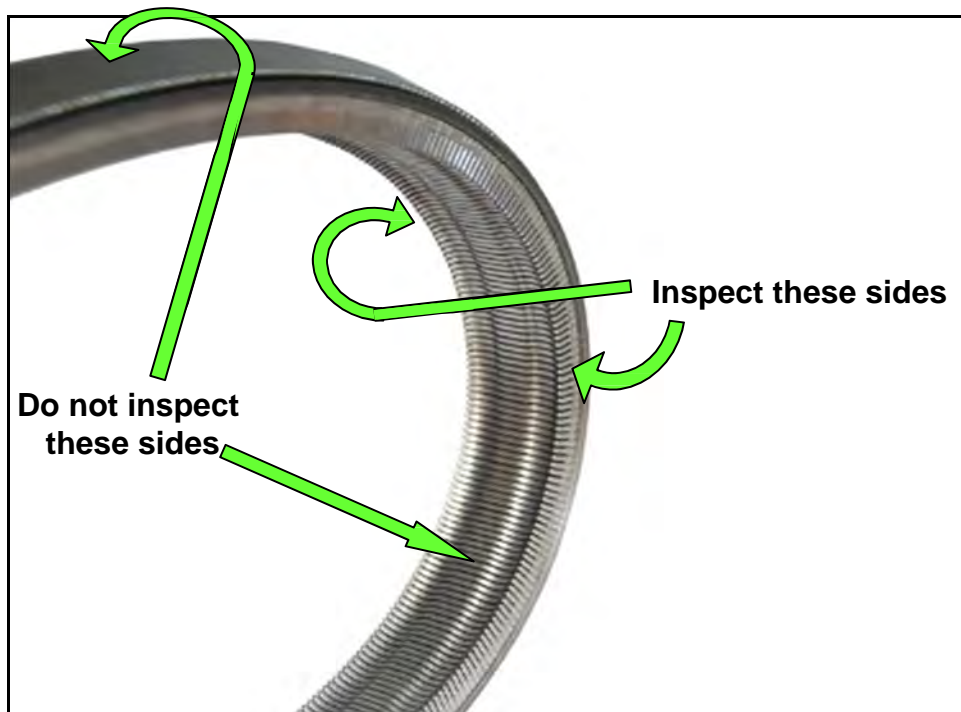

Figure 28

- a. Install the Clutch Engagement Tool (J-52273) to the CVT case with two bolts, finger tight, where shown in Figure 29 and Figure 30.
 - Bolt torque not to exceed: 2.26 N•m (0.23 kg-m, **20 in-lb.**)

NOTICE

- Use care when tightening the bolts as damage to the bolts/CVT could occur.
- Make sure an O-ring is installed to the Clutch Engagement Tool (J-52273) before installation as this could lead to improper/incomplete testing.

HINT: The O-ring for the Clutch Engagement Tool comes with the attachment. To order additional O-rings, refer to **PARTS INFORMATION** on page 140.

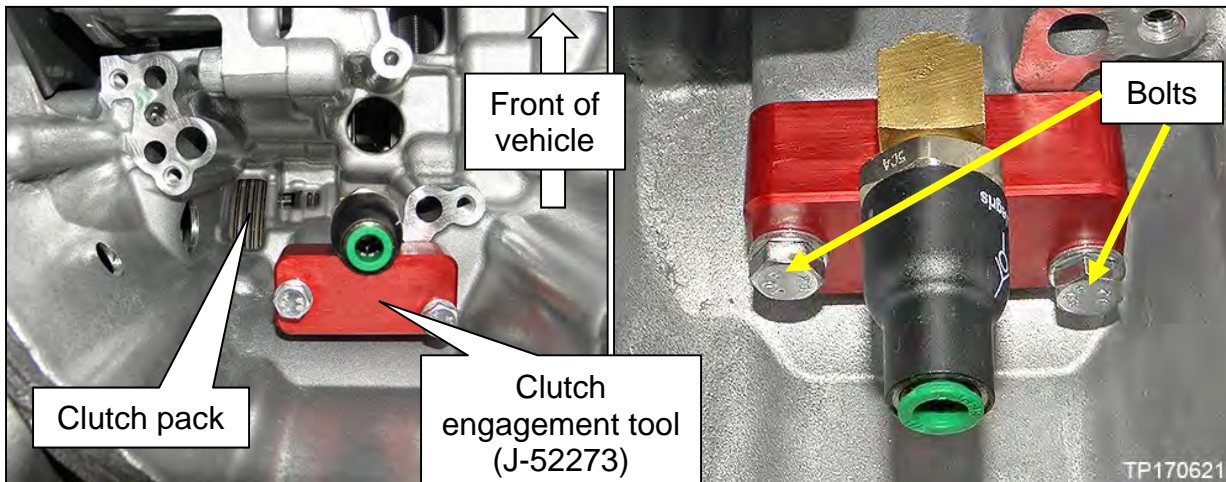

Figure 29

Figure 30

- b. Connect the hand pump from Evap Pressure Test Kit (J-42909) to the Clutch Engagement Tool (J-52273) and pump to 30 PSI (Figure 31).

IMPORTANT:

- Proper pressure has been achieved when the CVT belt moves while the driver side (LH) front wheel is rotated and the CVT is in NEUTRAL with the passenger side (RH) front wheel secured.

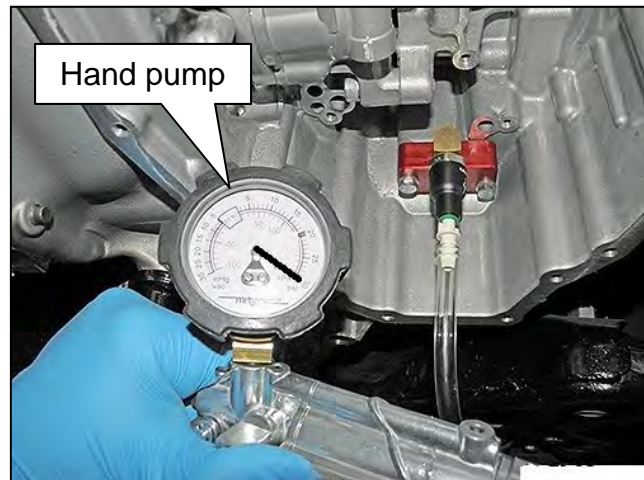

Figure 31

NOTICE

- Do NOT over-pressurize the system as internal damage to the CVT could result.
- The hand pump should be removed from the Clutch Engagement Tool (J-52273) quick connect once the clutch has been engaged and the belt is observed moving with tire rotation. Pressure will be retained.

c. Insert the borescope where shown in Figure 32 as follows:

- i. Face the mirror of the borescope toward the driver side of the vehicle (CVT side cover).
- ii. Insert the lens approximately 7.5 inches from the CVT oil pan gasket surface as shown in Figure 34 on page 22.
- iii. View the side of the belt that contacts the pulley.

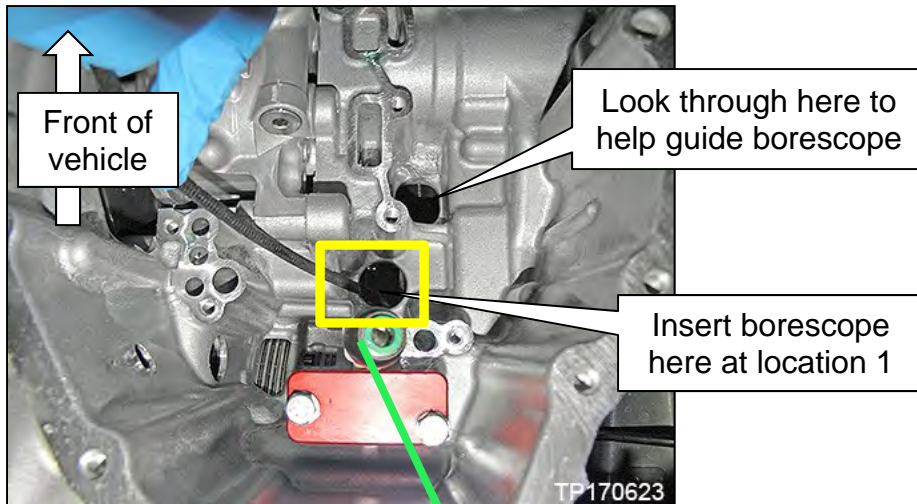

Figure 32

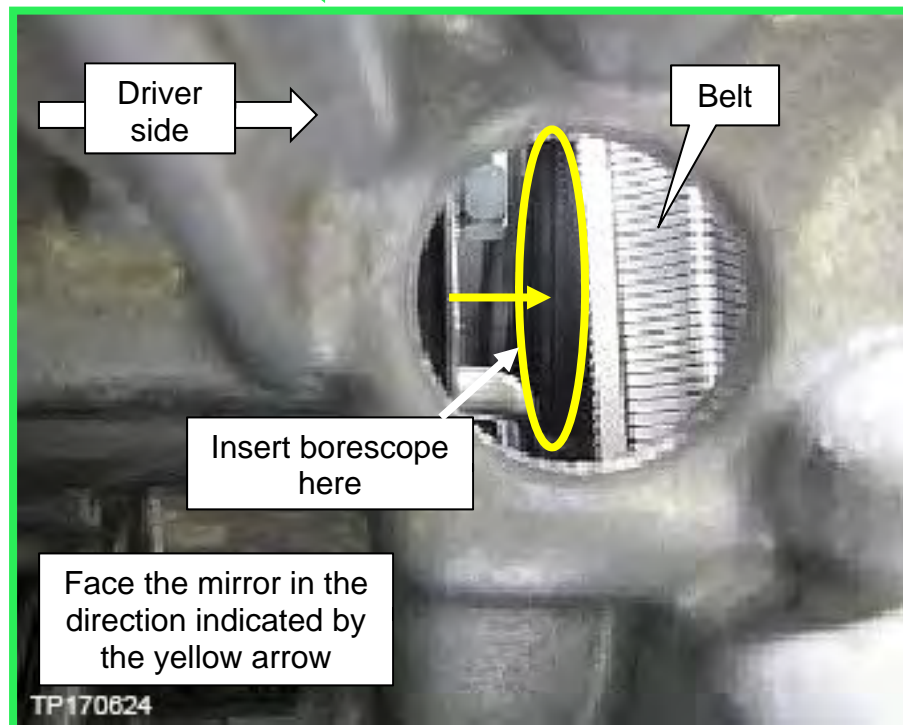

Figure 33

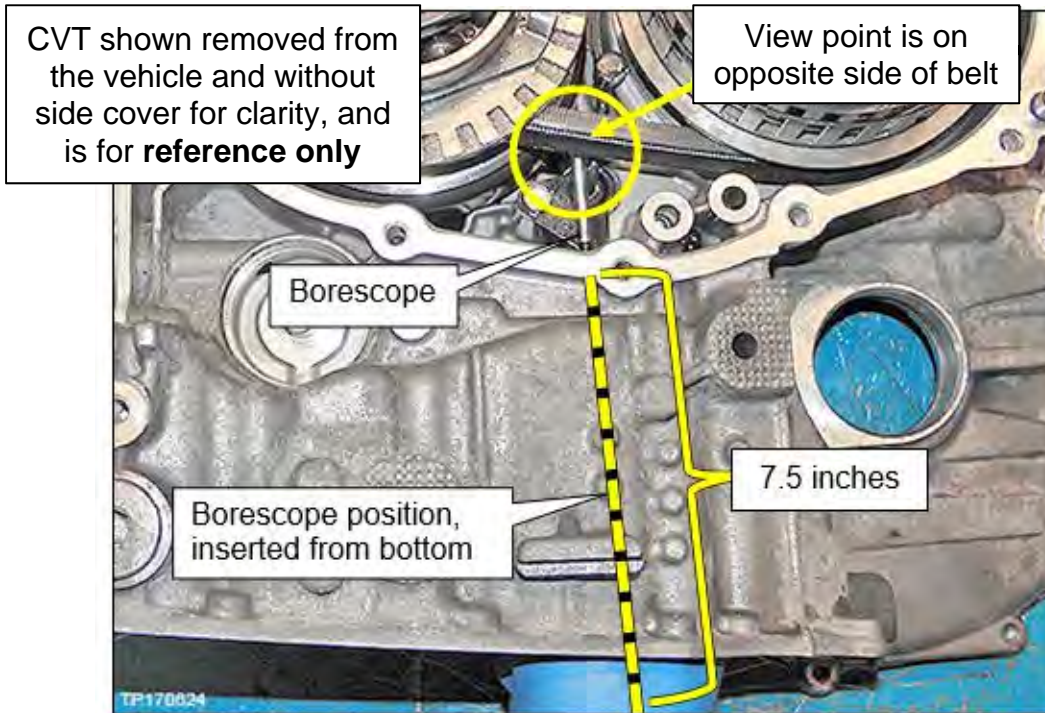

Figure 34

d. Using the mark applied to the driver side (LH) front wheel for reference, slowly and carefully rotate the driver side (LH) front wheel one full turn in either direction to view all of the belt.

- Holding the borescope (camera flexible tube) with one hand allows rotation of the wheel with the other hand (Figure 35).
- If evidence of belt slip is identified, as shown in Figure 44 through Figure 48 on pages 28 - 29, skip to step 26 on page 33.
- If the belt does not move when rotating the driver side (LH) front wheel, return to step 17b on page 20.



Figure 35

e. If the inspection result confirms that no slippage has occurred on the observed side, inspect the other side of the belt as follows:

For the following steps print this page as a template and then shape the borescope camera flexible tube like the image in Figure 36.

- Do not shrink or enlarge the sheet size when printing.
- The template shown is actual size when printed on 8.5" x 11" paper.

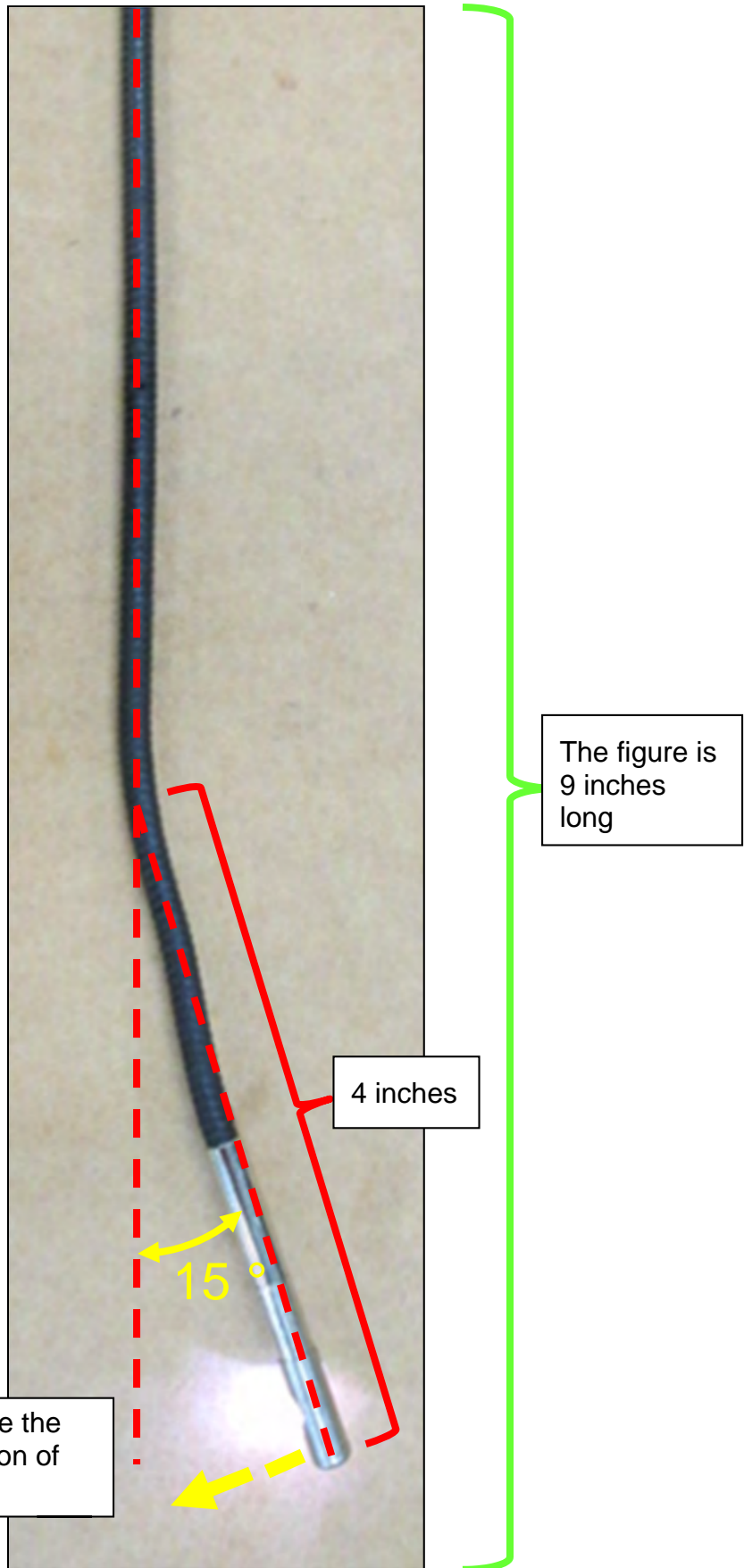

Figure 36

- i. Face the mirror of the borescope toward passenger side (engine side).
- ii. Insert the borescope in the second location where shown in Figure 37 and Figure 38.
- iii. Insert the lens approximately 8.7 inches from the CVT case rim as shown in Figure 39 on page 25.
- iv. View the side of the belt that contacts the pulley.

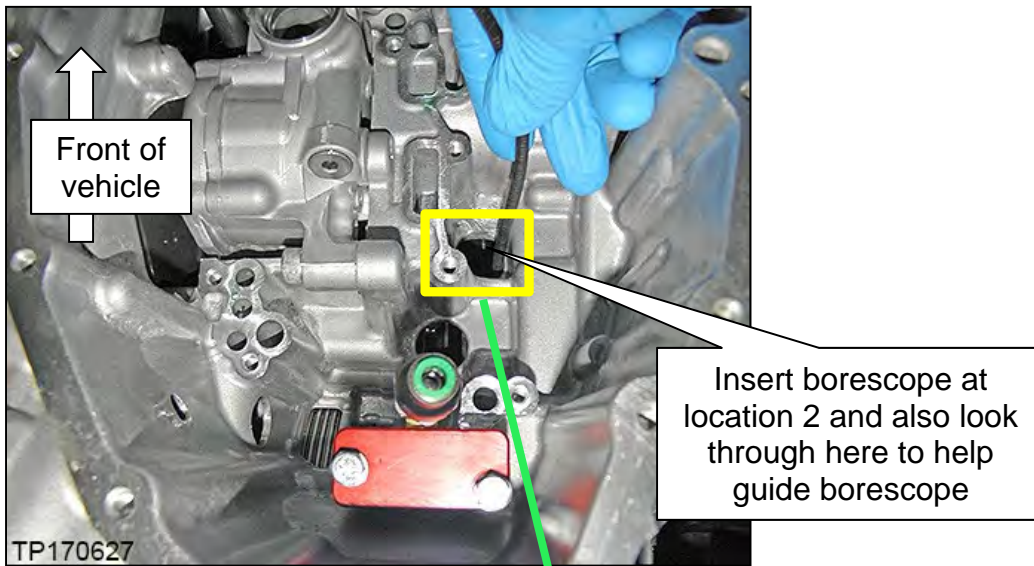

Figure 37

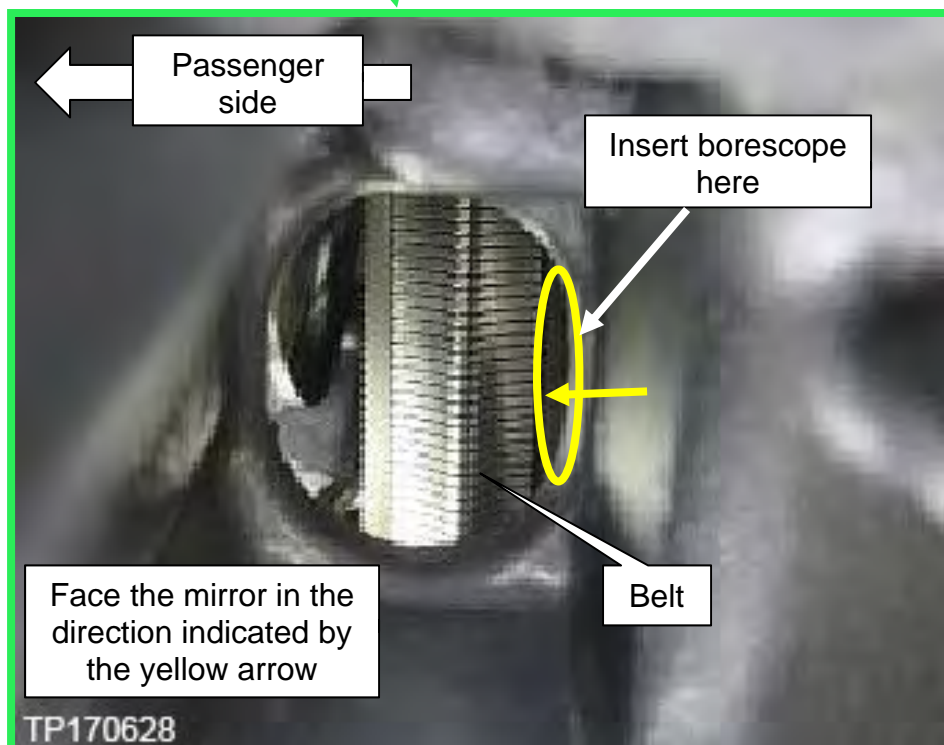

Figure 38

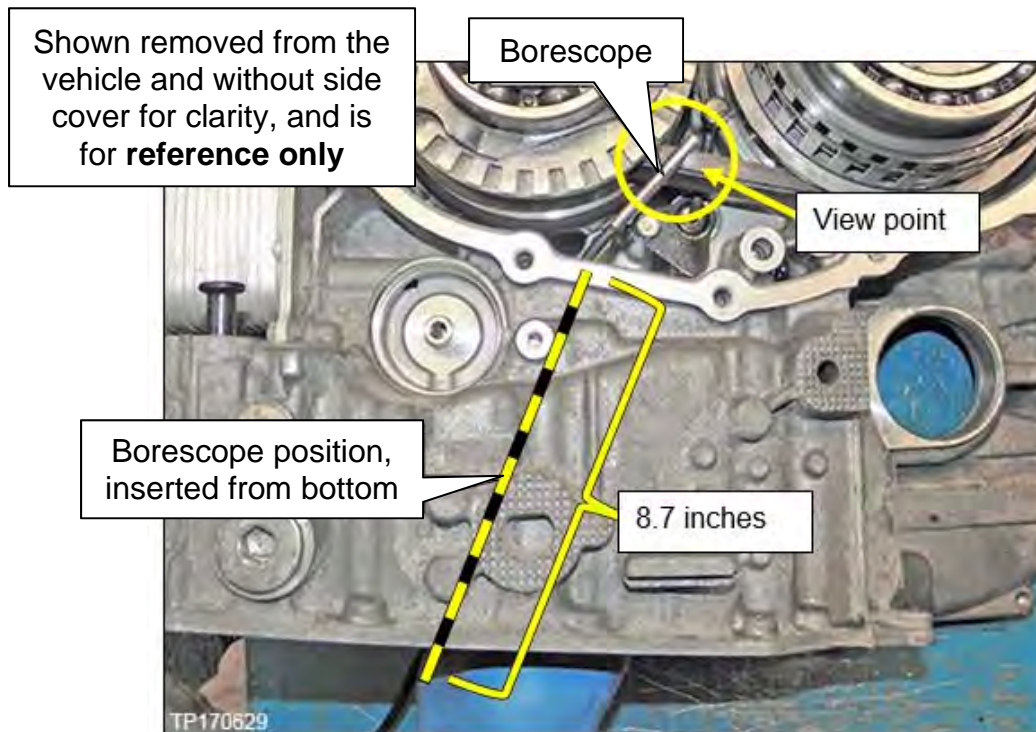

Figure 39

- f. Using the mark applied to the driver side (LH) front wheel for reference, slowly and carefully rotate the driver side (LH) front wheel one full turn in either direction to view all of the belt.
 - i. Holding the borescope (camera flexible tube) with one hand allows rotation of the wheel with the other hand (Figure 35).

HINT: If the belt does not move when rotating the driver side (LH) front wheel, supply additional air with hand pump (J-45664) to re-engage the clutch as necessary.
 - ii. Look for evidence of belt slip as shown in Figure 44 through Figure 48 on pages 28 - 29.
- g. Is the inspection result OK (no evidence of slip) for 360° rotation of both sides of the belt?

YES: Go to step 18 on page 30.

NO: Skip to step 26 on page 33.



TP170630

Figure 40



TP170631

Figure 41

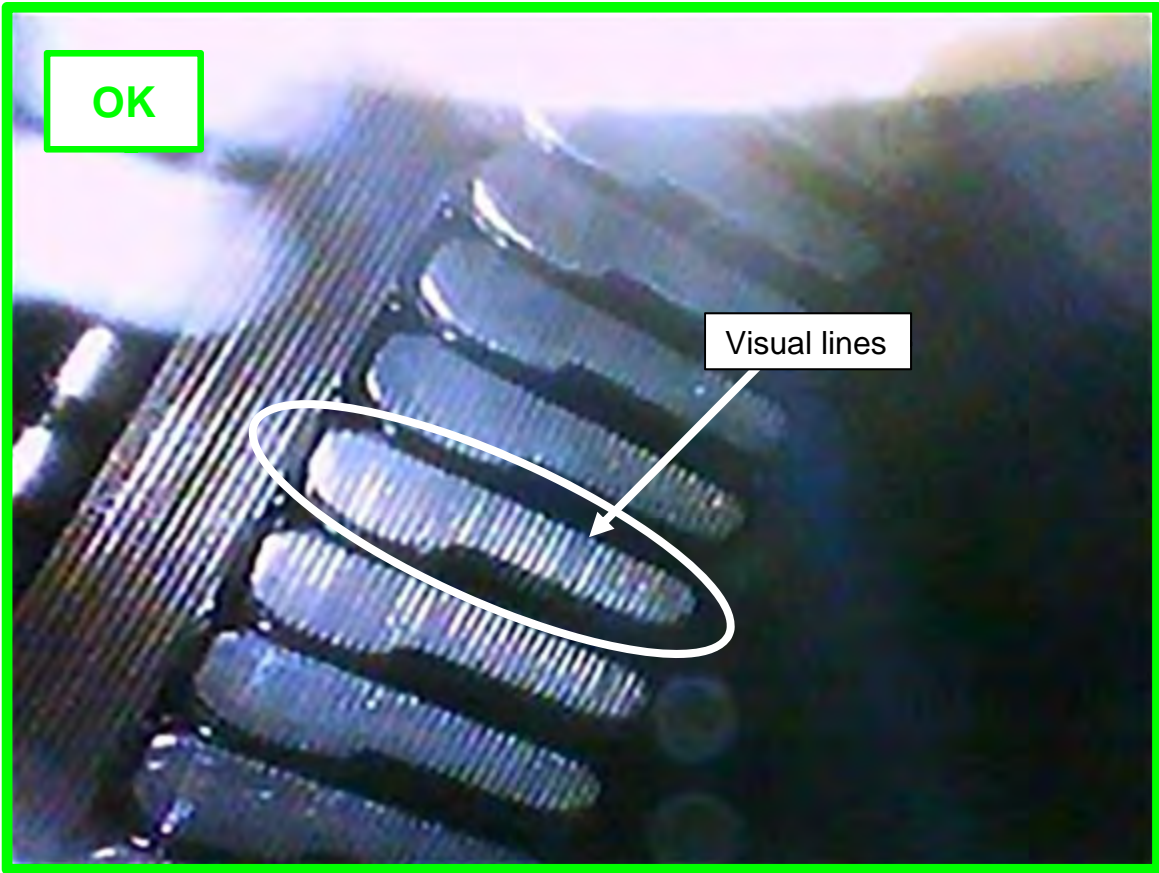

Figure 42

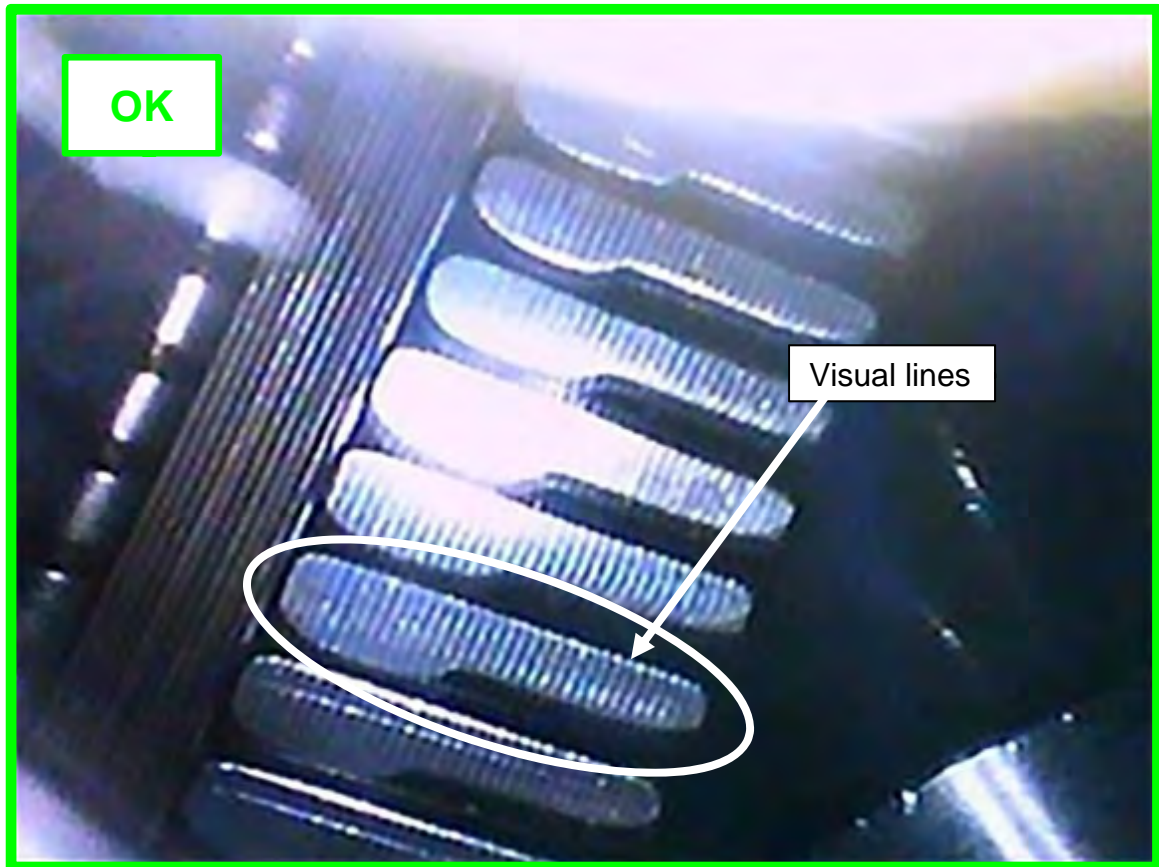

Figure 43

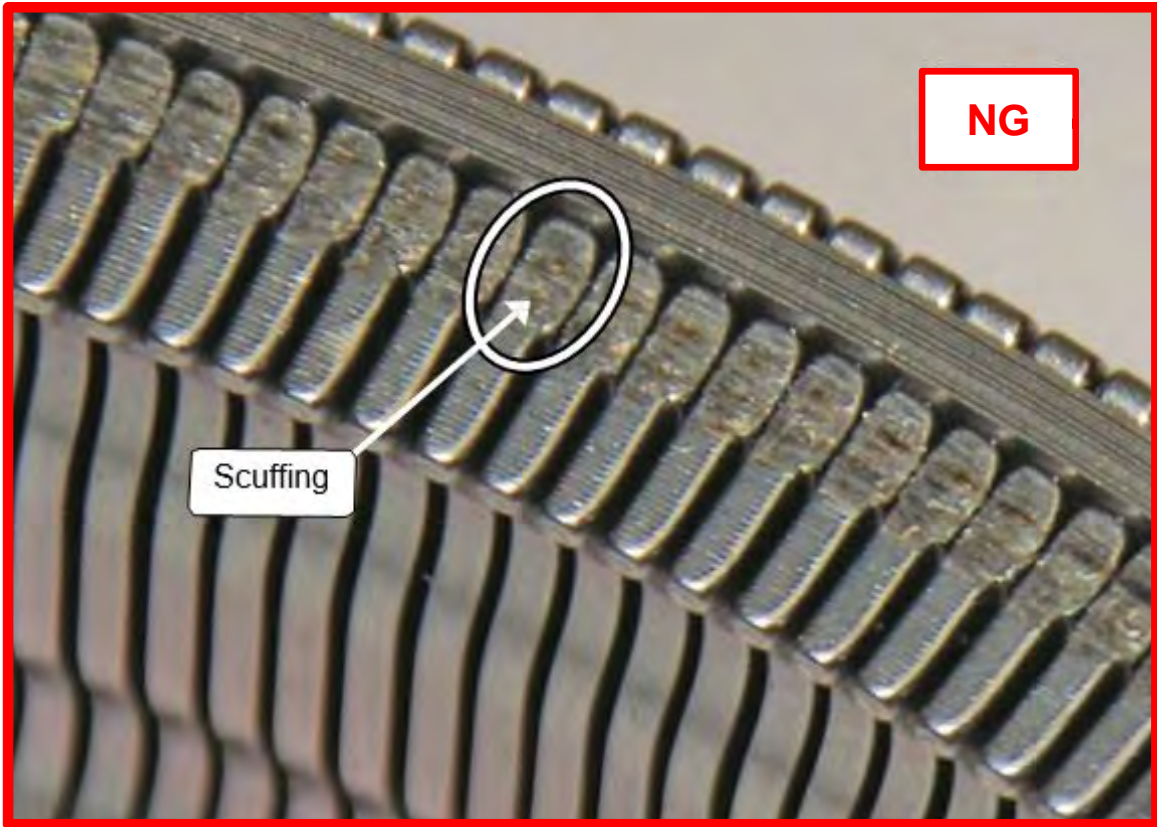

Figure 44

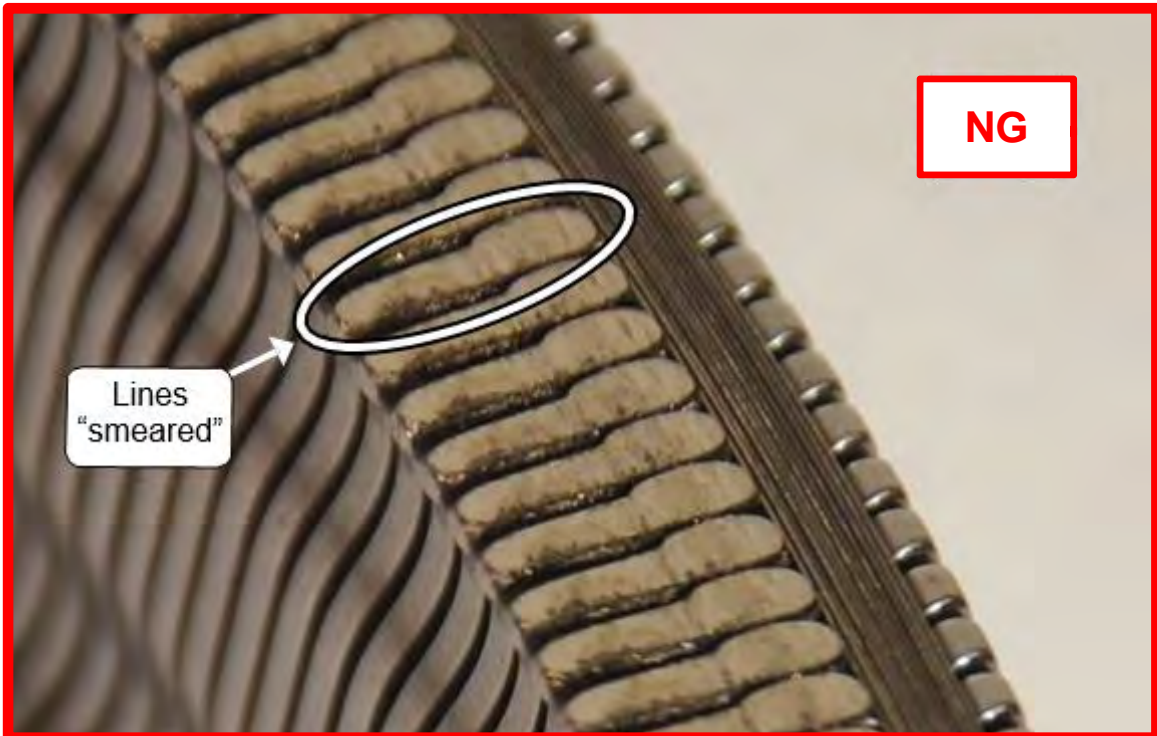

Figure 45



Figure 46



Figure 47



Figure 48

Pulse Rotor Inspection

18. Check for looseness in the pulse rotor using special tools Pulse Rotor Lock J-52728 and Wheel Lug Torque Adapter Set J-52729.

- a. Remove the secondary speed sensor. Refer to the ESM, section **TRANSMISSION & DRIVELINE > TRANSAXLE & TRANSMISSION > CVT: RE0F11A > REMOVAL AND INSTALLATION > SECONDARY SPEED SENSOR**.
 - Remove the O-ring from the secondary speed sensor. The O-ring is a one-time use part. Do not reuse.

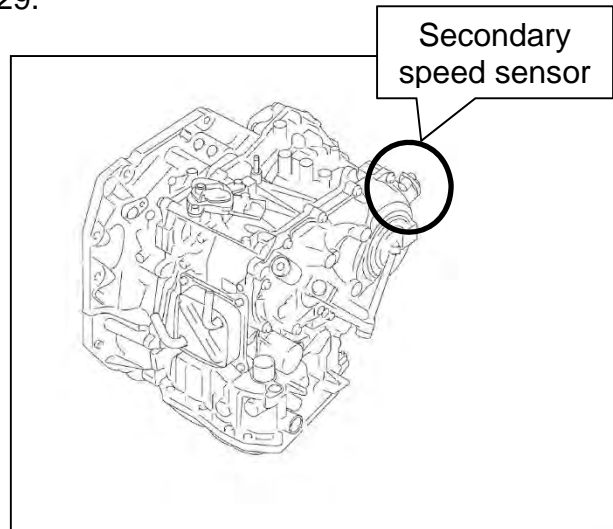

Figure 49

- b. Install the Pulse Rotor Lock Tool J-52728 into the secondary speed sensor hole and tighten the bolt to 5.9 N•m (0.60 kg-m, **52 in-lb.**)
- c. Using the Wheel Lug Torque Adapter Set J-52729-1 and an appropriate torque wrench, apply torque to the driver side (LH) front wheel (Figure 50).
- d. Smoothly apply a maximum torque of 25 N•m (2.5 kg-m, **18 ft-lbs**) in a forward driving direction (counter-clockwise at driver side [LH] front wheel).

- A slight movement in the front wheel is considered normal due to gear lash.



Figure 50

- e. Was maximum torque 25 N•m (2.5 kg-m, **18 ft-lbs**) achieved without wheel spin in a forward direction?
 - **YES:** Continue to step 18f on page 31.
 - **NO:** Skip to step 18h on page 31.

f. Smoothly apply a maximum torque of 25 N•m (2.5 kg-m, **18 ft-lbs**) in a reverse driving direction (Clockwise to the driver side (LH) front wheel).

- A slight movement in the front wheel is considered normal due to gear lash.



Figure 51

g. Was maximum torque 25 N•m (2.5 kg-m, **18 ft-lbs**) achieved without wheel spin in either direction?

- **YES:** Skip to step 19 on page 32.
- **NO:** Continue to step 18h.

h. If the driver side (LH) front wheel spins in either direction, check the following:

- Ensure the passenger side (RH) front wheel is not moving when applying torque as referenced in step 18d on page 30 and step 18f on page 31.
- If the passenger side (RH) front wheel is moving, check that the strap securing the passenger side (RH) front wheel is secure.
- If the CVT belt is NOT moving while the wheel spins return to step 17b on page 20 and verify the clutch engagement tool is at 30 PSI.

i. If the driver side (LH) front wheel still spins in either direction after checking all of the possible causes in step 18h, a loose pulse rotor is confirmed. Skip to step 26 on page 33.

No Belt Damage and Pulse Rotor Not Loose – Replace Control Valve

19. Remove the Pulse Rotor Lock Tool J-52728 if previously installed.

20. Reinstall the secondary speed sensor if previously removed.

- Refer to the ESM, section **TRANSMISSION & DRIVELINE > TRANSAXLE & TRANSMISSION > CVT: RE0F11A > REMOVAL AND INSTALLATION > SECONDARY SPEED SENSOR.**
- The secondary speed sensor O-ring is a one-time use part. Do not reuse.

HINT: See Reference # 19 in the **KIT PARTS REFERENCE TABLE.**

21. Remove the Clutch Engagement Tool J-52273 from the CVT.

CAUTION To avoid the risk of minor personal injury, place a rag over the Clutch Engagement tool and SLOWLY loosen the two bolts until the audible depressurization is noted. The remaining CVT fluid may spray when the Clutch Engagement Tool is removed.

22. Install a new control valve in the reverse order of disassembly:

- Refer to steps 163 - 174 on pages 91 - 93.

23. Connect both battery cables, negative cable last.

24. Reset/reinitialize systems as needed.

- Refer to the ESM, section **GENERAL INFORMATION > GENERAL INFORMATION > BASIC INSPECTION > INSPECTION AND ADJUSTMENT > ADDITIONAL SERVICE WHEN REMOVING BATTERY NEGATIVE TERMINAL,** for a listing of systems that require reset/initialization after reconnecting the 12V battery.
- This list often includes items such as radio, power windows, clock, sunroof, etc.

25. Perform **Additional Service When Replacing Control Valve or Transaxle Assembly** starting on page 106.

Belt Damaged or Pulse Rotor Loose

26. Remove the Pulse Rotor Lock Tool (J-52728) if previously installed.

27. Remove the Clutch Engagement Tool (J-52273) from the CVT.

CAUTION To avoid the risk of minor personal injury, place a rag over the Clutch Engagement tool and SLOWLY loosen the two bolts until the audible depressurization is noted. The remaining CVT fluid may spray when the Clutch Engagement Tool is removed.

28. Install the original (removed) oil pan gasket and oil pan temporarily with at least two oil pan bolts, hand tight.

IMPORTANT: DO NOT discard the remaining oil pan bolts. These bolts will be reused.

29. Continue to step 30.

Remove CVT from the Vehicle and Disassemble External Parts

30. Remove the CVT from the vehicle.

- Refer to the FSM, section **TRANSMISSION & DRIVELINE > TRANSAXLE & TRANSMISSION > CVT: RE0F11A > UNIT REMOVAL AND INSTALLATION.**

31. Remove the torque converter and set aside.

- The torque converter may be reused if CVT replacement is not required.

32. Put the CVT assembly on a work bench with the oil pan side down.

CAUTION

- To avoid minor personal injury, use assistance when placing the CVT on the work bench.

NOTICE

- Use care when placing the CVT on the work bench to avoid damage to the oil pan or internal CVT components.

33. Drain the CVT fluid out of the torque converter.

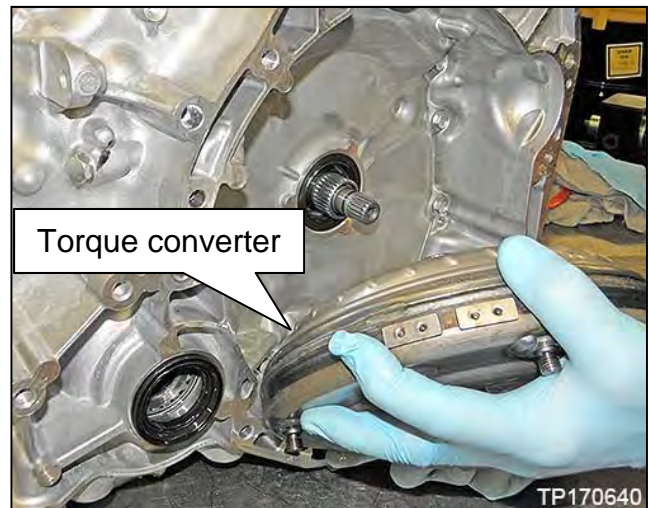

Figure 52



Figure 53

34. Remove the output speed sensor, primary speed sensor and secondary speed sensor from the CVT (Figure 54, Figure 55 and Figure 56).

- These sensors will be reused.
- Inspect all three sensors for debris on the magnet and clean as necessary.

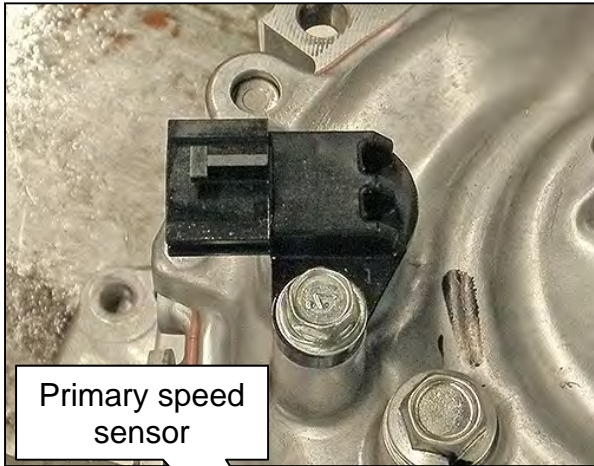

Figure 54

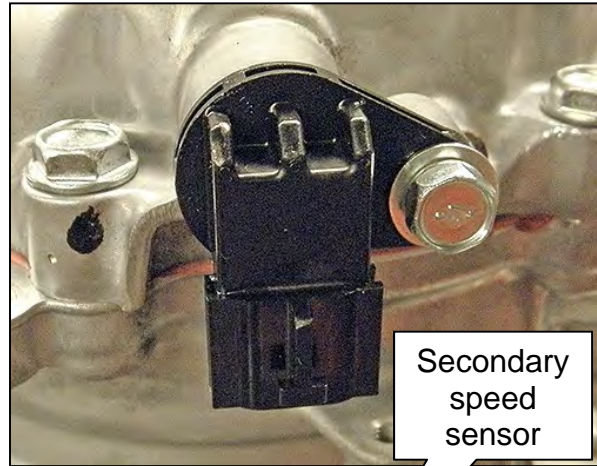

Figure 55

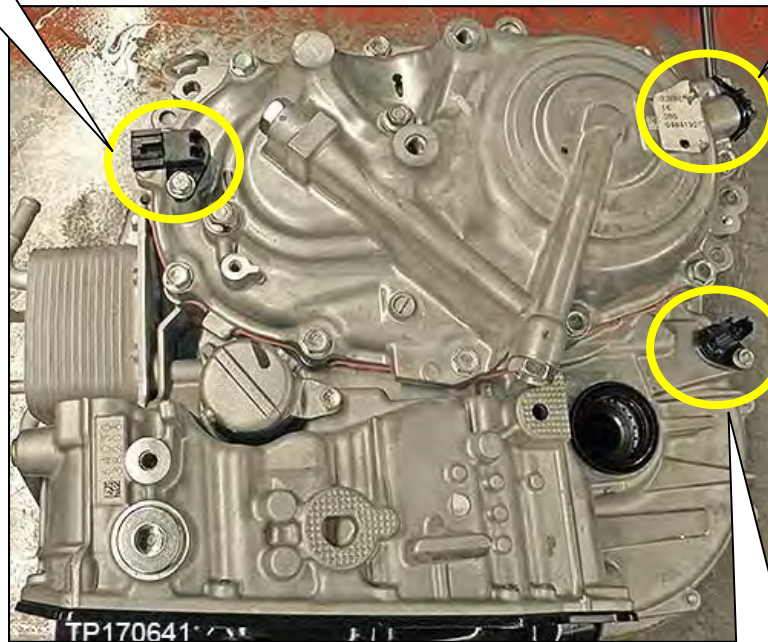

Figure 56

35. Remove the O-rings from all three speed sensors.

- The O-rings are one-time use parts. Do not reuse.

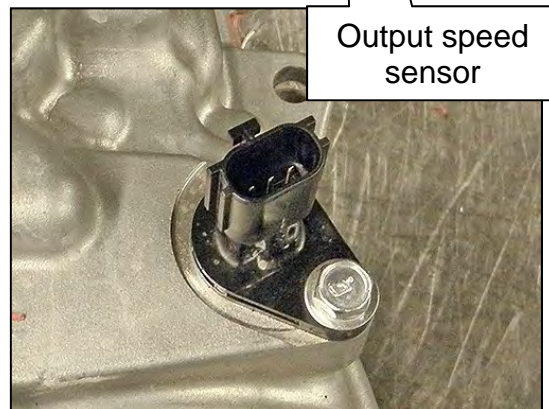

Figure 57

Remove the Fluid Filter

36. Remove the fluid filter from the CVT case as follows:

- a. Remove the fluid filter cover bolt.
 - This bolt will be reused.

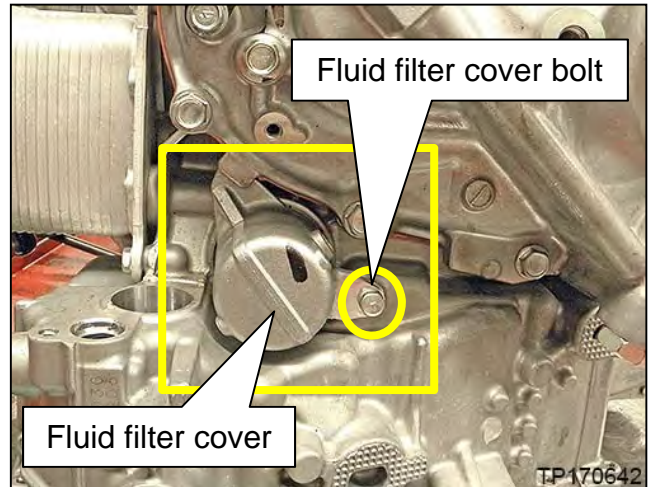

Figure 58

- b. Rotate the fluid filter cover counterclockwise approximately 15 degrees or until the cover clears the side cover tab.
- c. Pull the fluid filter cover away from the CVT case to remove.

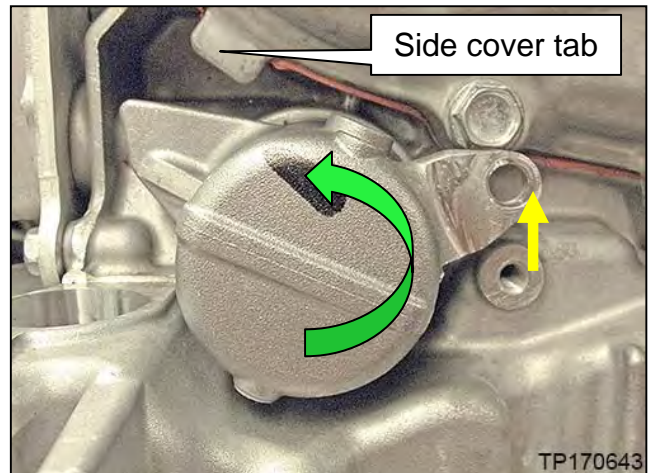

Figure 59

37. Pull the fluid filter with grommet away from the CVT case to remove.

- The filter is a one-time use part. Do not reuse.

NOTE: The grommet may separate from the filter and remain on the CVT case.

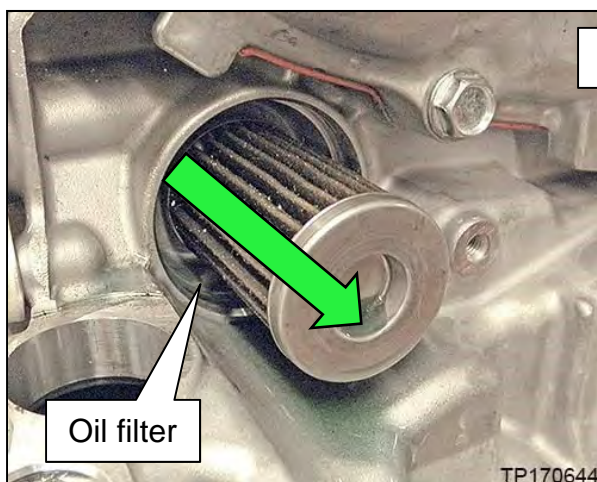

Figure 60



Figure 61

38. Remove the O-ring from the fluid filter cover.

- The O-ring is a one-time use part. Do not reuse.



Figure 62

39. Thoroughly wipe and clean the inside of the fluid filter cover.

- Brake cleaner may be used during this step to thoroughly remove any residual material.



Figure 63

40. Thoroughly wipe and clean the filter bore of the CVT case.

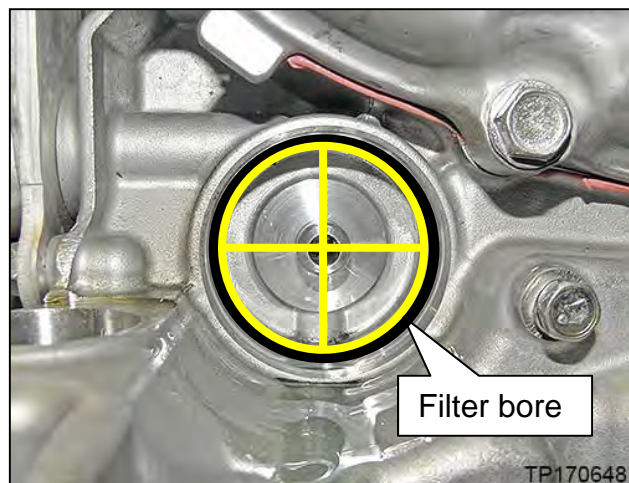

Figure 64

Remove the Oil Pan and Torque Converter Housing

41. Reposition the CVT assembly on the work bench with the torque converter housing side facing up.

- Use plastic or wood blocks to stabilize the CVT assembly on the work bench if needed.

NOTE: CVT fluid will drain from the CVT case when the oil pan is removed.

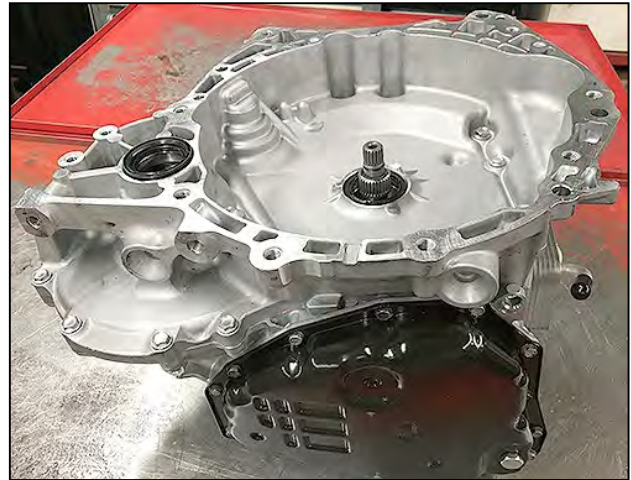

Figure 65

42. Remove the oil pan and oil pan gasket which were installed to the CVT temporarily.
Bolts will be reused.

- Keep the original oil pan for installation during reassembly.

43. Remove the nineteen (19) bolts circled in yellow shown in Figure 66 from the torque converter housing.

- Do not discard these bolts. They will be temporarily re-used later in this procedure.

NOTE: The bolts that are not visible in Figure 66 are indicated with a dotted yellow circle.

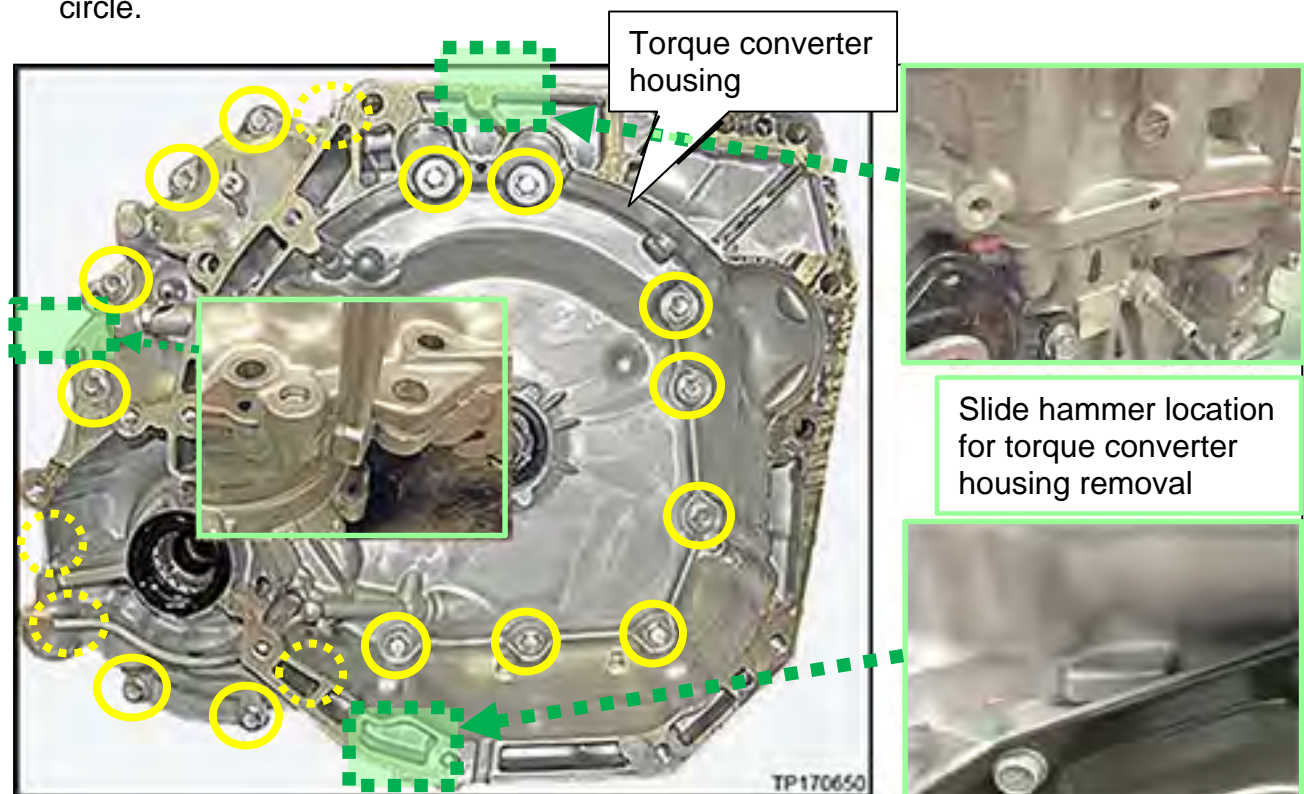

Figure 66

44. Remove the torque converter housing from the CVT case.

- If necessary, use a Slide Hammer J-25721-A at the three locations (highlighted in green) shown in Figure 66.
- The input shaft thrust bearing washer may be attached to the torque converter housing, remove it and put it aside; it will be reused.

Remove the Oil Seals from the Torque Converter Housing

45. Remove the torque converter oil seal from the torque converter housing with a suitable tool.

- Take care not to damage the seal-to-case surface when removing seal.
- The torque converter oil seal is a one-time use part. Do not reuse.

46. Remove the differential side oil seal from the torque converter housing with a suitable tool.

- The differential side oil seal is a one-time use part. Do not reuse.

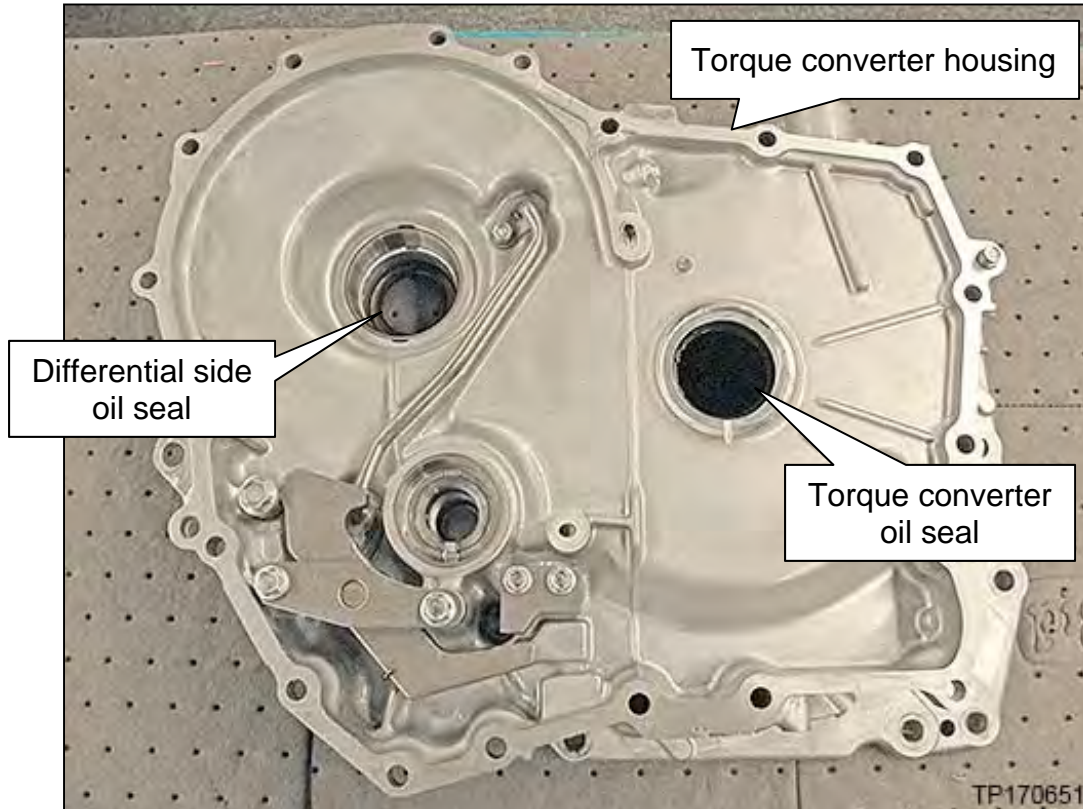

Figure 67

Remove the CVT Internal Components

47. Remove the final drive assembly and the reduction gear assembly at the same time by lifting both straight up.

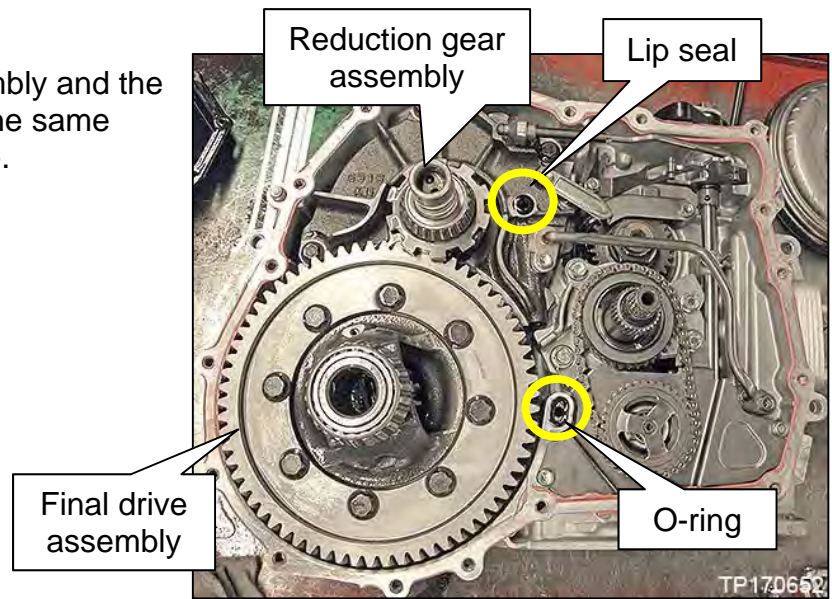

Figure 68

48. Remove the lip seal from the CVT case.

- The lip seal is a one-time use part. Do not reuse.

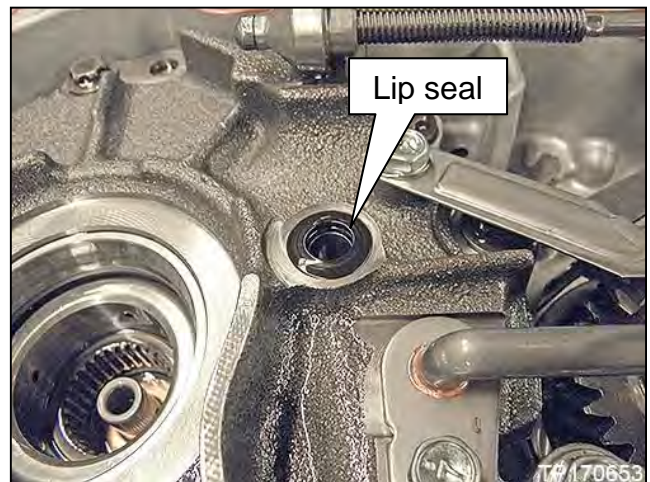

Figure 69

49. Remove the O-ring from the CVT case.

- The O-ring is a one-time use part. Do not reuse.

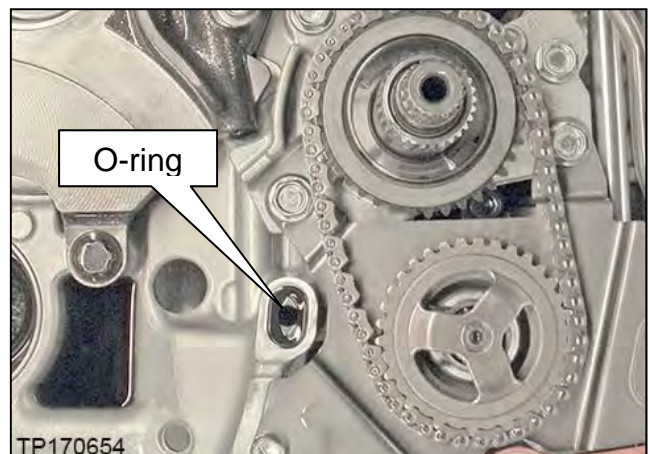

Figure 70

50. Remove the O-ring from the input shaft.

- The O-ring is a one-time use part. Do not reuse.

51. Remove the thrust bearing from the drive sprocket and set aside to reuse during re-assembly.

NOTE: The thrust washer for the thrust bearing may either be on the drive sprocket or may have remained with the torque converter housing when it was removed.

- The thrust washer will be reused later in this procedure.

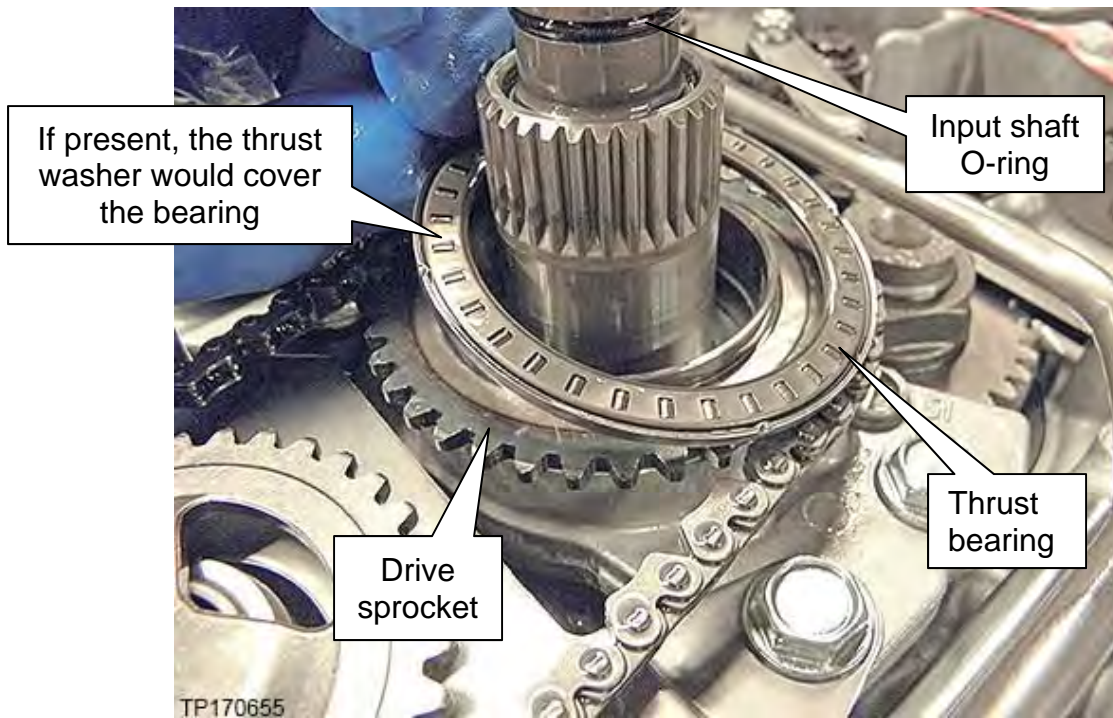

Figure 71

52. Spread the snap ring shown in Figure 72 and Figure 73 then remove both sprockets and the chain.

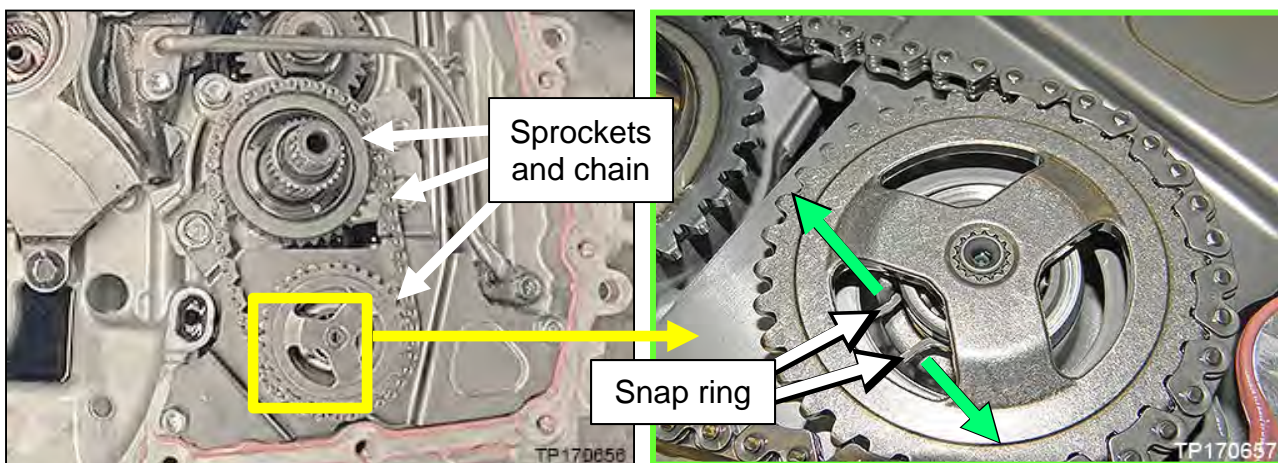

Figure 72

Figure 73

53. Remove the parking rod from the detent plate.

- Rotate the parking rod vertically to align the tab on the parking rod (Figure 75) with the slot on the detent plate and then separate from the detent plate.

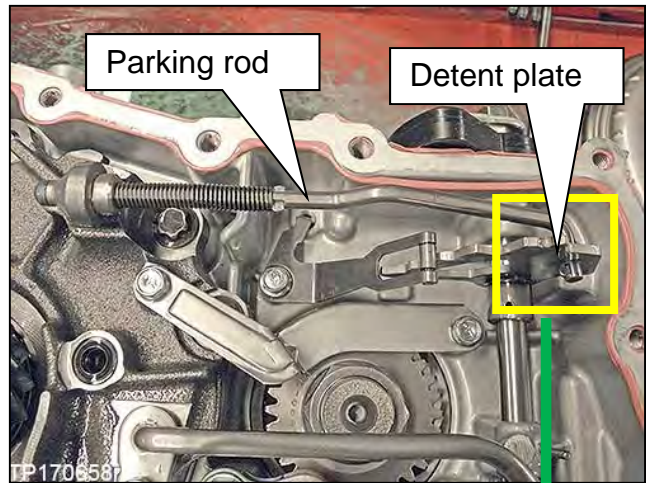

Figure 74

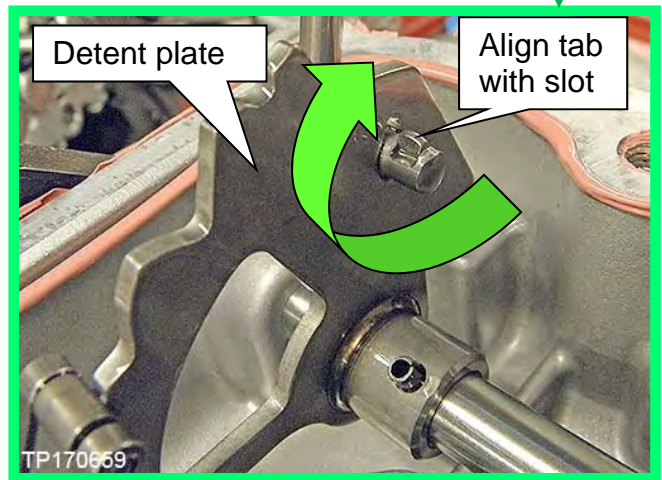

Figure 75

54. Remove the two (2) bolts shown in Figure 76, and then remove the reverse brake tube from the CVT.

- Do not discard. These will be reused during assembly.

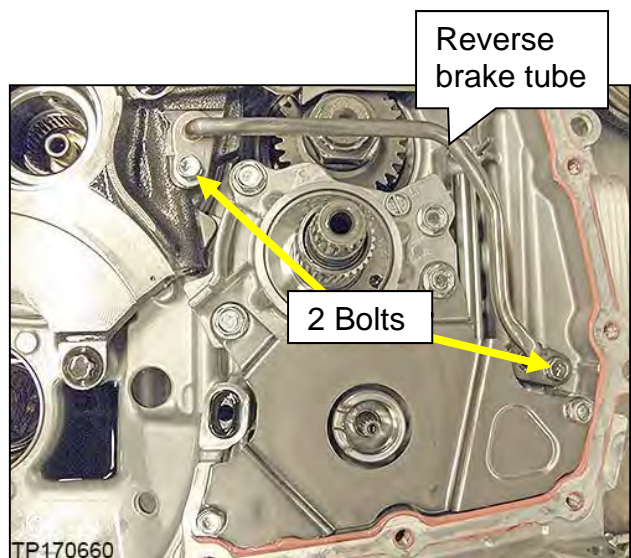

Figure 76

55. Remove the sleeve from the reverse brake tube.

- The sleeve is a one-time use part. Do not reuse.

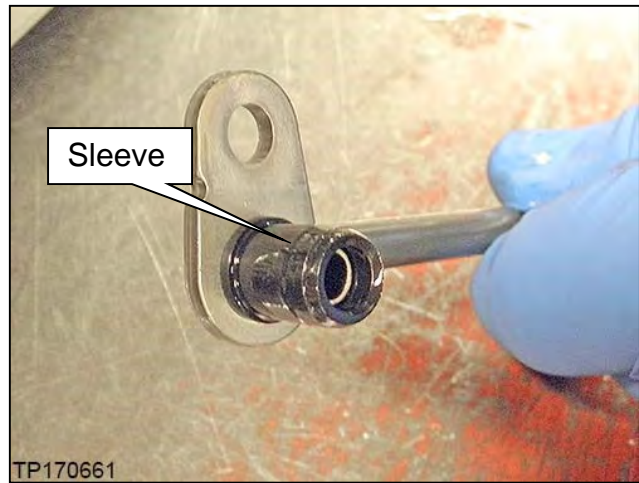

Figure 77

56. Remove the six (6) bolts shown in Figure 78, and then remove the chain cover.

- Do not discard. The bolts and chain cover will be reused during assembly.

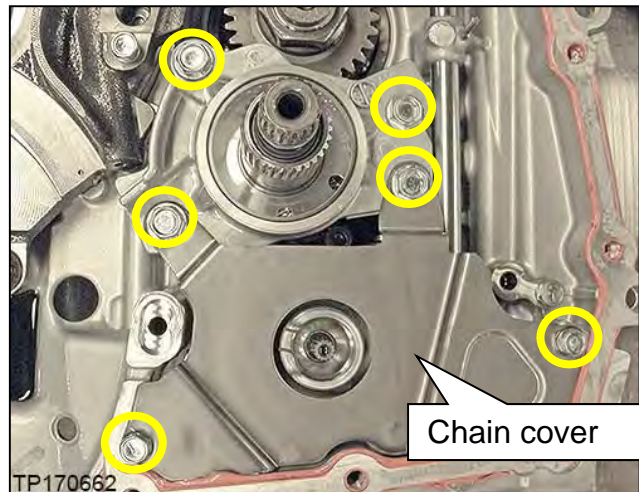

Figure 78

57. Remove the input shaft assembly and the oil pump cover (dummy cover) from the CVT as a unit.

- Hold the input shaft assembly by the end, as shown in Figure 79, and pull straight up to remove.

HINT: The dummy cover, shaft and bearing will separate if the input shaft is not held at the end.

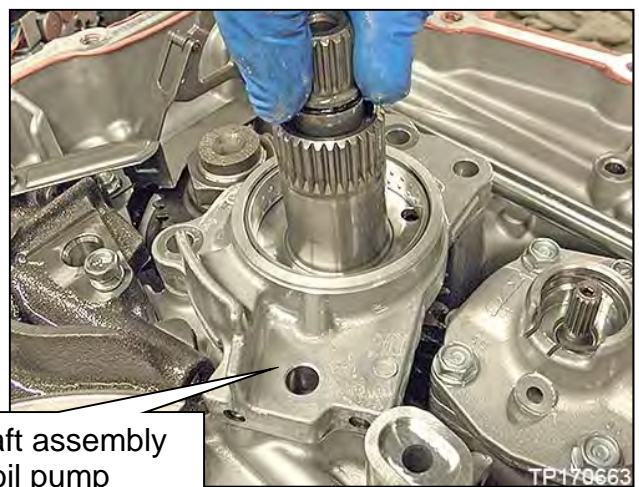

Figure 79

58. Confirm the “type” of bearing used on the end of the input shaft, and then proceed to the indicated step.

- For type “A” roller bearing proceed to step 59.
- For type “B” ball bearing skip to step 61 on page 45.
- For type “C” sealed ball bearing skip to step 61 on page 45.



Bearing type A

Figure 80

Bearing type B and C
(type C shown)

59. Remove the outer race of the roller bearing from the counter bearing bore of the CVT case by hand.

NOTICE Do not use excessive force to remove the bearing race as damage to the CVT may occur. A magnet can be used to lift this bearing if needed.

HINT: The outer race of the roller bearing might remain on the shaft when removing the input shaft and dummy cover.

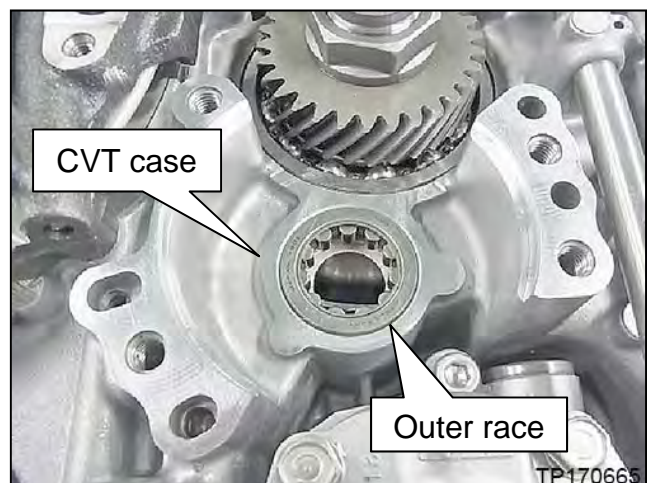

CVT case

Outer race

Figure 81

60. Inspect type “A” bearing (Roller bearing) as follows:

- Inspect the bearing outer race and input shaft for flaking or pitting.
- Install the bearing outer race onto the input shaft assembly with the “bearing number” facing the gear, and then rotate the bearing while applying an axial load by hand to check for any abnormality.

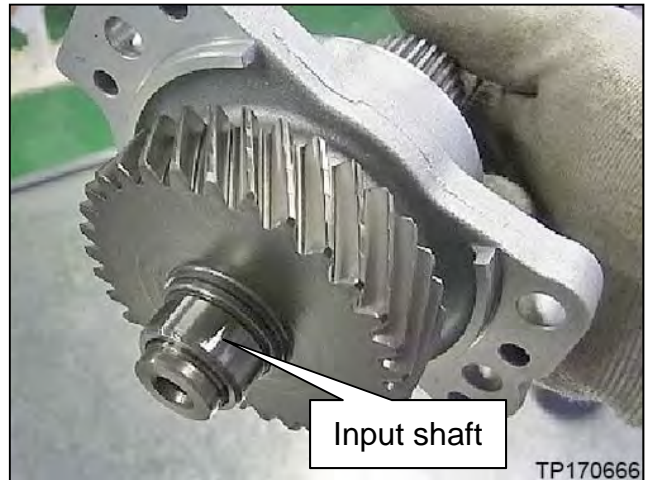

Figure 82

NOTICE DO NOT drop the outer race of the bearing to avoid damage and/or contamination.

- Were any abnormalities found or felt in the bearing (sound, flat spots, flaking)?
 - **NO:** Put bearing and shaft aside and then skip to step 62 on page 45.
 - **YES:**
 - a. Document the abnormalities found with a video and then contact the PCC for authorization to replace the CVT. See page 148 for PCC contact information.
 - b. Refer to steps 203 - 207 on page 105 when replacing the CVT.
 - c. After CVT replacement, perform **ADDITIONAL SERVICE WHEN REPLACING CONTROL VALVE OR TRANSAXLE ASSEMBLY** on page 106.
 - d. Loosely reassemble the original CVT in the reverse order of disassembly with the original parts.

61. Inspect type “B” and type “C” bearings (ball bearing) as follows:

- Apply an axial load and rotate the bearing by hand to check for any abnormality (sound, flat spot, flaking).



Figure 83

- Were any abnormalities observed in the bearing when applying an axial load (sound, flat spots, flaking)?
 - **NO:** Proceed to step 62.
 - **YES:**
 - a. Document the abnormalities found with a video and then contact the PCC for authorization to replace the CVT. See page 148 for PCC contact information.
 - b. Loosely re-assemble the CVT in the reverse order of disassembly with the original parts.
 - c. Refer to steps steps 203 - 207 on page 105 when installing the CVT.
 - d. After CVT replacement, perform **ADDITIONAL SERVICE WHEN REPLACING CONTROL VALVE OR TRANSAXLE ASSEMBLY** on page 106.

62. If the bearing is judged to be OK, remove the shim (Figure 84) from the bottom of the counter bearing bore.

- A magnet can be used to remove the shim if needed.
- This shim will be reused later in this procedure.

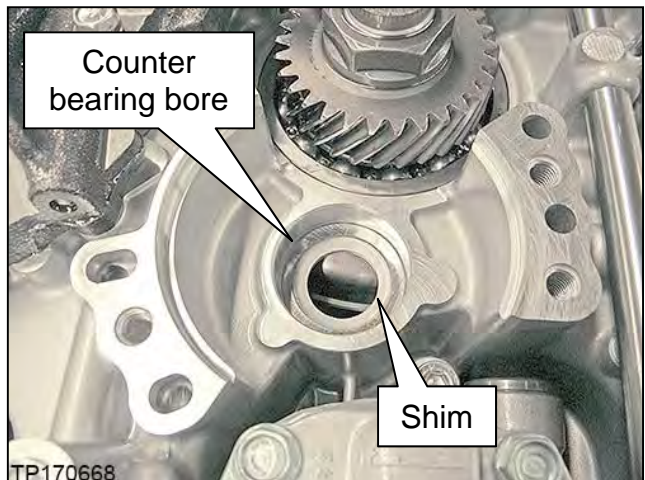

Figure 84

63. Remove the differential side oil seal from the CVT case by driving it away from the case with a suitable tool.

- The differential side oil seal is a one-time use part. Do not reuse.
- Take care not to damage the seal-to-case surface when removing seal.

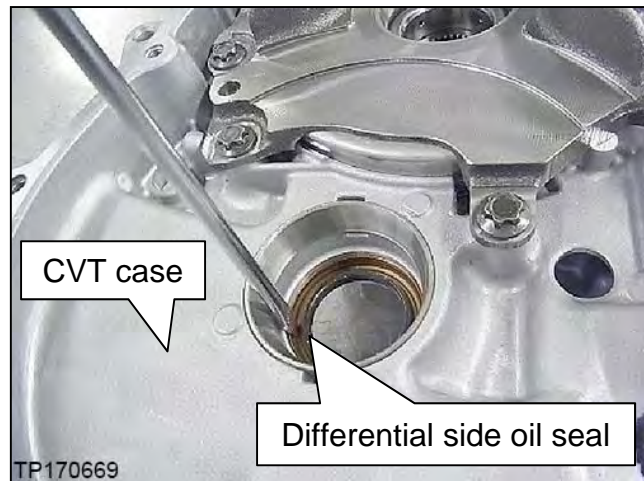

Figure 85

64. Rotate the manual shaft (Figure 86) until it stops in the Park position (see Figure 87).

NOTICE Confirm that the detent plate is in the Park position before proceeding. Do not remove the roll pin in any other position. This will allow pin removal and avoid damage to the case.

65. Remove the roll pin completely from the manual shaft with a 3 mm punch.

- The roll pin is a one-time use part. Do not reuse.

NOTICE Use a 3 mm punch. If a larger sized punch is used, the hole may become enlarged and damage the manual shaft.

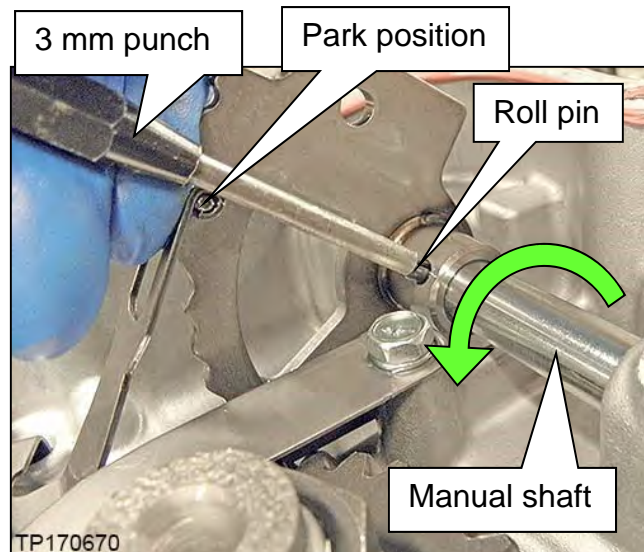

Figure 86

66. Remove the detent spring bolt shown in Figure 87 and then remove the detent spring from the CVT case.

- Do not discard the bolt. It will be reused during reassembly.

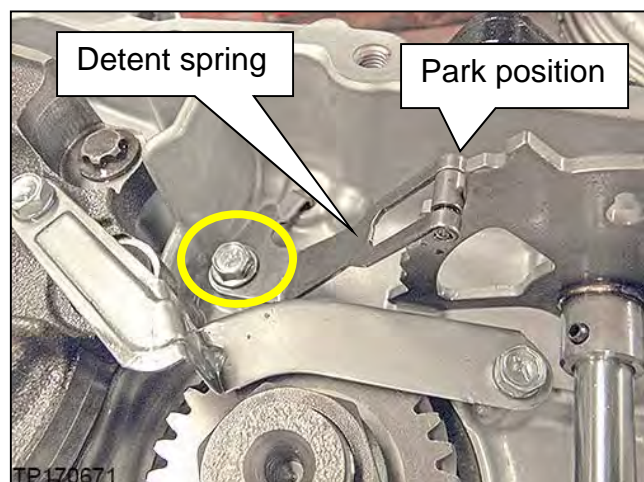

Figure 87

67. Remove the manual shaft retaining pin (straight pin) from the CVT case by grasping and pulling vertically by hand.

- Do not discard the pin. It will be reused during reassembly.

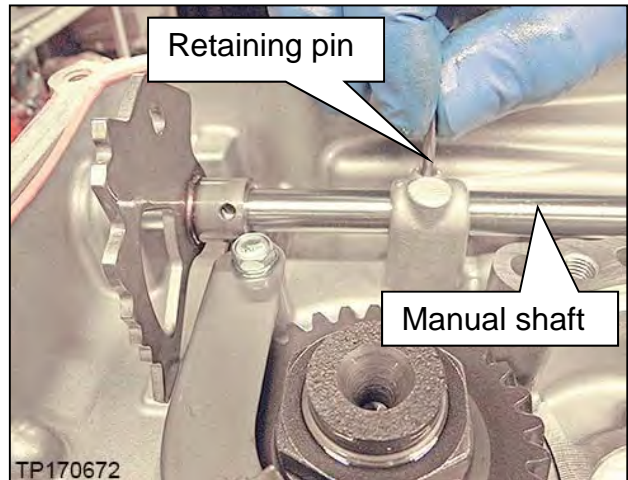

Figure 88

68. Remove the two (2) bolts shown in Figure 89 for the transmission range switch.

- Do not discard the bolts. They will be reused during reassembly.

HINT:

- DO NOT remove the manual shaft lock nut at this step.
- DO NOT try to remove the transmission range switch from the manual shaft.

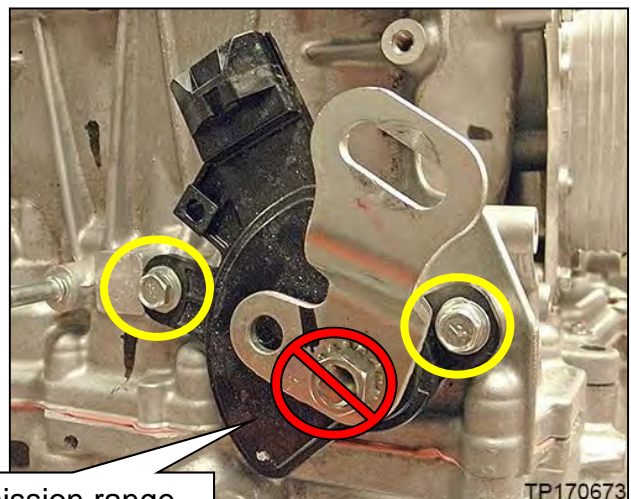

Figure 89

69. Slide the manual shaft approximately 5.3 inches (135 mm) out of the CVT case to allow removal of the oil pump (step 70).

NOTICE

Do not remove the manual shaft completely from the CVT case. If the retaining pin slot contacts the seal, damage may occur.

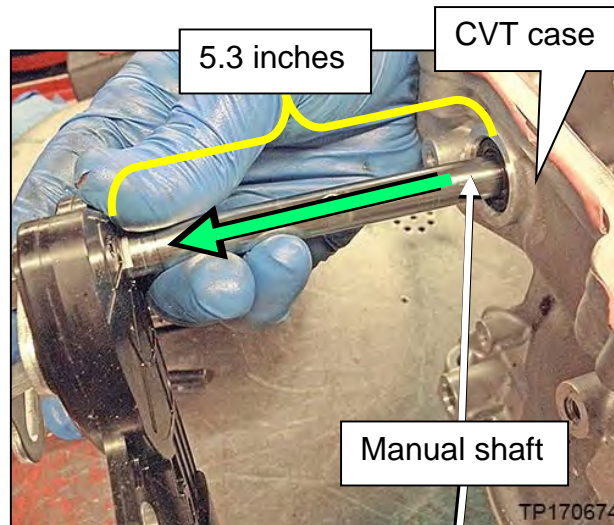

Figure 90

70. Remove the three (3) Allen® bolts shown in Figure 91 and then remove the oil pump from the CVT case.

- This oil pump will not be reused, it will be replaced with a new one.
- Do not discard Allen® bolts. They will be reused during reassembly.

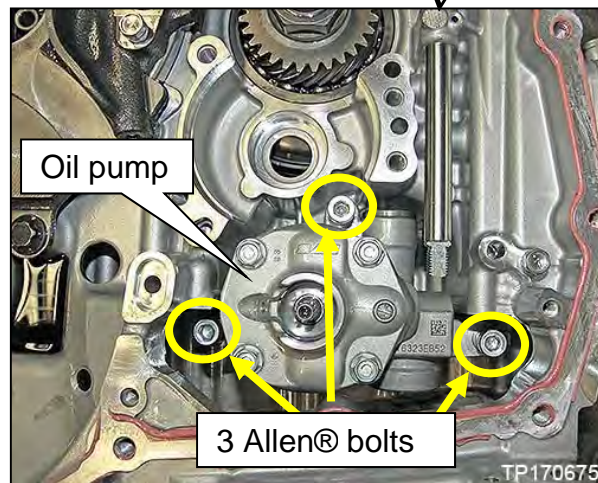

Figure 91

71. Remove the snap ring from the original oil pump.

HINT: DO NOT discard the removed snap ring. This snap ring will be reused.



Figure 92

72. Remove the oil pump gasket from the CVT case.

- The oil pump gasket is a one-time use part. Do not reuse.

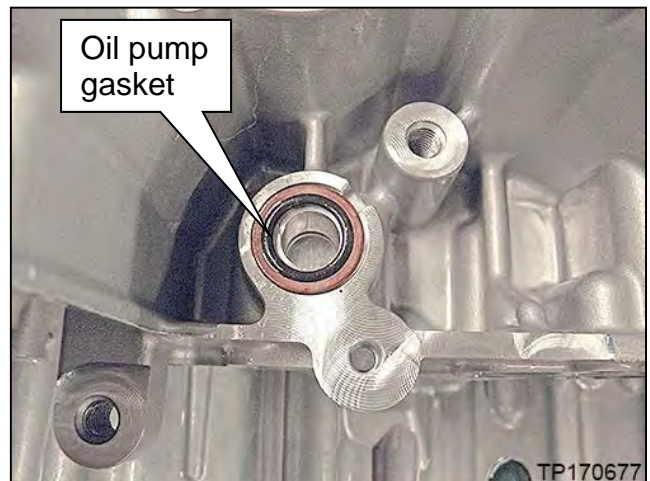

Figure 93

73. Temporarily install the transmission range switch with the two (2) original bolts removed in step 68 on page 47, finger tight.

- The transmission range switch will be permanently installed later in this procedure.

Remove the Sub-assembly

IMPORTANT: Steps 74 through 81 are **ONLY** to separate the sealant of the side cover. The sub-assembly with belt and pulley **CANNOT** be removed from the CVT while in this orientation and will be removed from the case at a later step.

74. Reposition the CVT on the work bench with the torque converter housing side down.

HINT: A wood block may be used to stabilize the CVT during disassembly/reassembly.

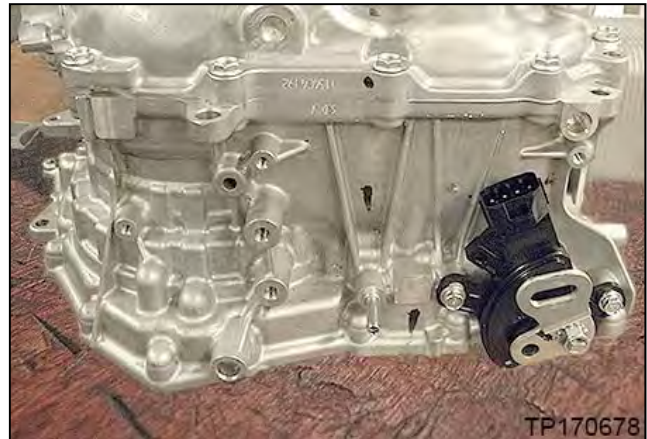

Figure 94

75. Remove the two (2) pulley bearing retainer bolts shown in Figure 95.

- Do not discard bolts. They will be temporarily installed during a later step.

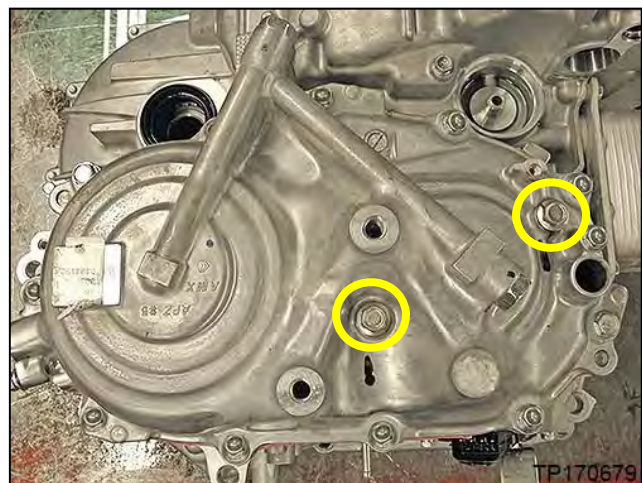

Figure 95

76. Remove the eleven (11) side cover bolts shown in Figure 96.

- Retain two (2) of these bolts. They will be temporarily installed during a later step.

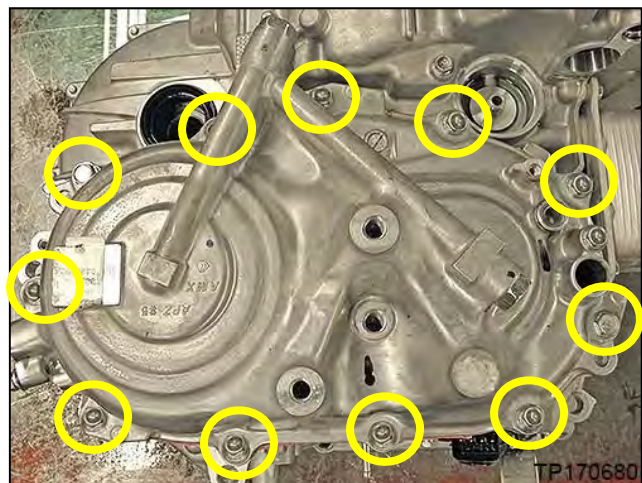

Figure 96

77. Remove the side cover with a slide hammer J-25721-A to separate the side cover and CVT case.

- There are three slide hammer tool points shown in Figure 97.
- The mating surfaces will be cleaned at a later step.
- This step will help with sub-assembly removal at a later step.

NOTICE

- To avoid damage to the CVT, do not use the speed sensor bore for slide hammer tool location.
- Do not pry the surfaces apart as internal CVT damage may result.

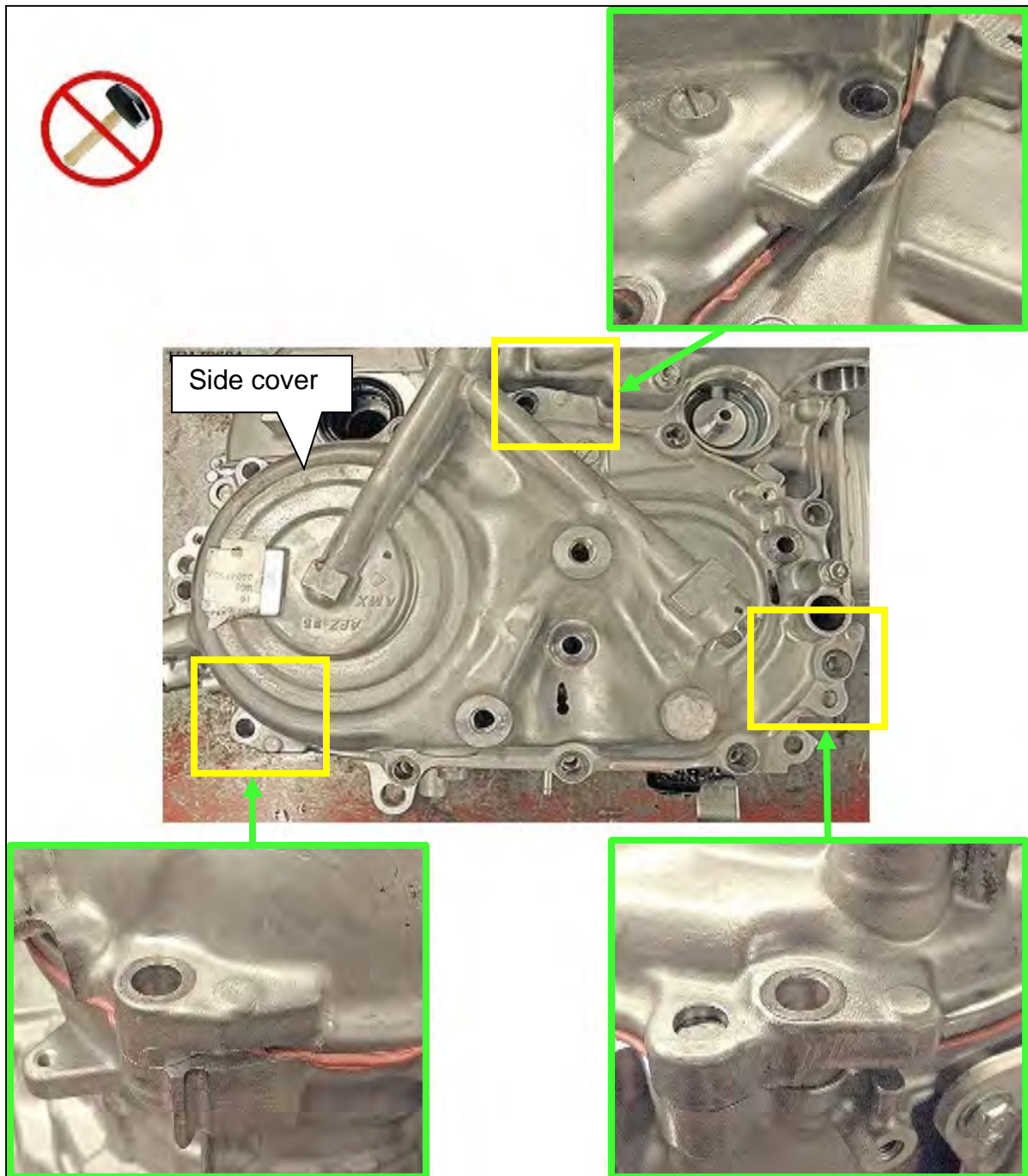

Figure 97

78. Align the primary pulley bearing retainer bolt holes with the bolt hole on the case as shown in Figure 98.

HINT: This helps alignment of the bearing retainer bolt threads after reinstalling the original side cover.

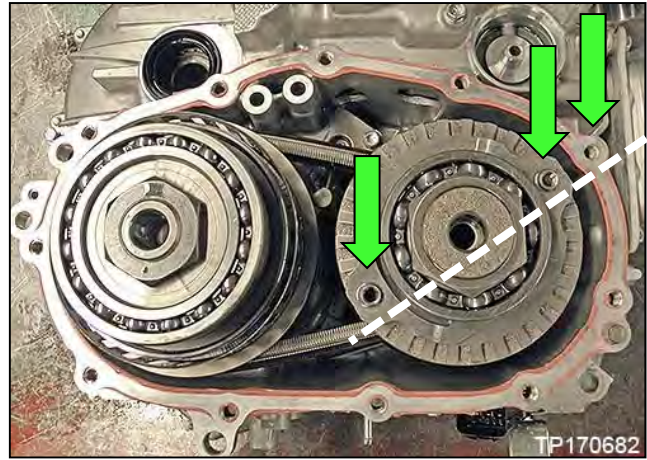

Figure 98

79. Install one of the “Assembly Guide Pins, Pulley Bracket” (Guide Pin J-52272) to one of the two pulley bearing retainer bolt holes.

- This will assist in installation of the original side cover to the pulley assembly.

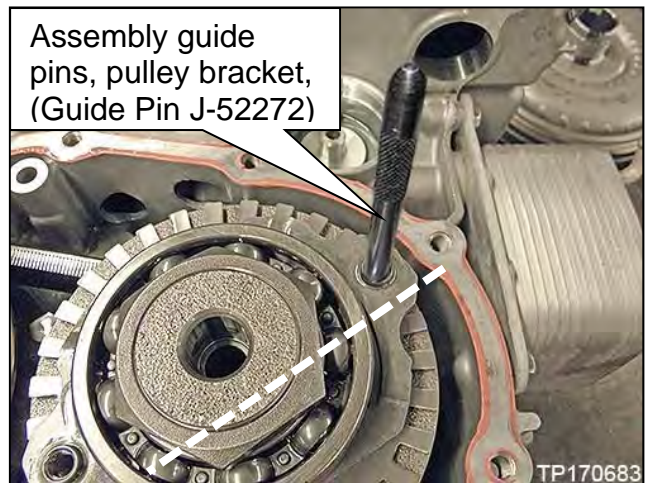

Figure 99

80. Place the original side cover onto the CVT case.

- Position the primary pulley bearing retainer to allow the guide pin to be inserted through the bolt hole of the side cover.



Figure 100

81. Install the two (2) original pulley bearing retainer bolts (Figure 101) as follows:

- Use the original bolts and O-rings at this step.
 - a. Install one pulley bearing retainer bolt finger tight into open bearing retainer bolt hole.
 - b. Remove the guide pin from the other bearing retainer bolt hole.
 - c. Install the other bearing retainer bolt by hand (finger tight).

82. Temporarily reattach the removed side cover onto the CVT case with two (2) original bolts on opposite corners, hand tight.

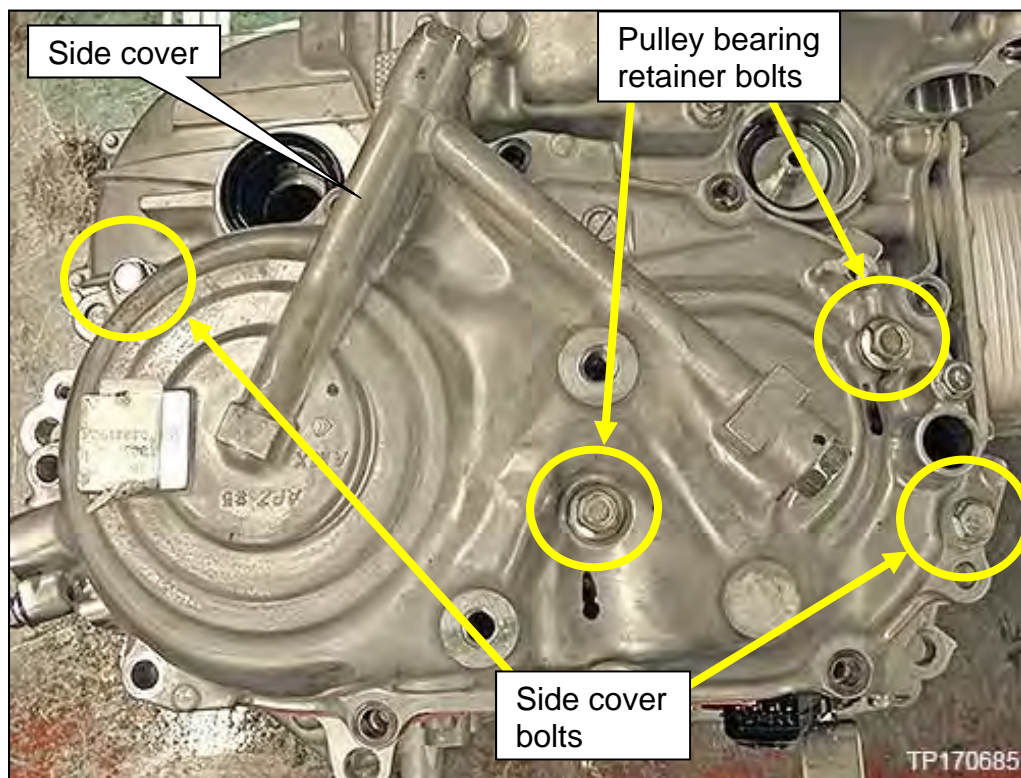

Figure 101

83. Reposition the CVT with the side cover facing down.

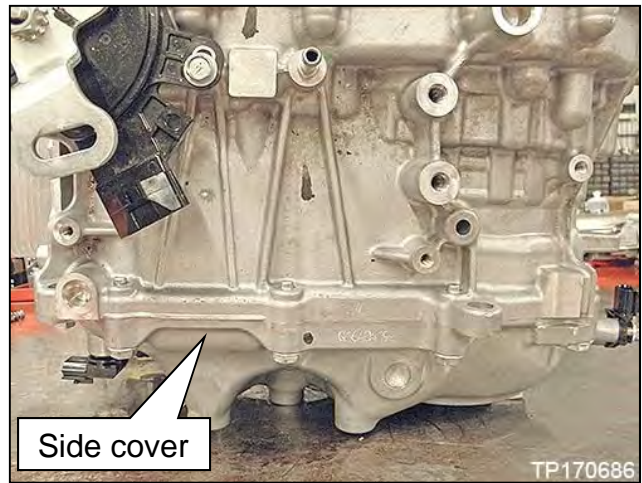

Figure 102

84. Remove the two (2) side cover bolts which were temporarily installed to hold the side cover to the CVT in step 82 on page 53.

HINT: Only one (1) bolt is shown in Figure 103 and is for reference only.



Figure 103

85. Lift the CVT case vertically off of the sub-assembly and side cover.

- Weight 17.4 kg (38.4 lbs.)
- This sub-assembly will not be reused.

IMPORTANT: The sub-assembly must be separated from the case as shown in Figure 104.



Figure 104

86. Place the CVT case on the work bench with the torque converter side facing down.



Figure 105

87. Remove the lubrication tube bolt, shown in Figure 106, and then remove the lubrication tube from the CVT case.

- Do not discard the bolt or lubrication tube. These will be reused during reassembly.

NOTICE To prevent drivability concerns, ensure that the lubrication tube is not bent during sub-assembly installation.

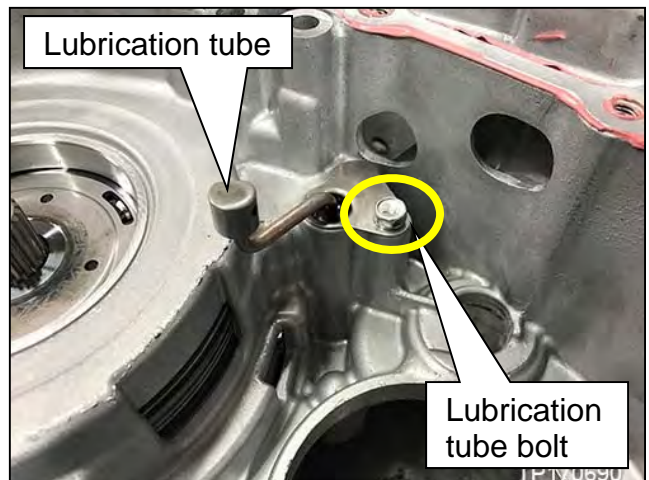

Figure 106

Clean the CVT Surfaces

NOTICE To avoid damage to the CVT and potential drivability concerns:

- Prevent any debris from dropping into the torque converter housing, side cover or the CVT case.
- Use brake cleaner to remove the remaining CVT fluid and any residual sealant.
- Do not use sanding discs, abrasive tools, or metal blades on sealing surfaces.
- Clean dowel pins with a mild abrasive sandpaper to remove all rust and debris.
 - This will assist at a later step when mating the CVT case to the sub-assembly and again when mating the CVT case to the torque converter housing.

88. Remove any sealant that remains on the sealing surface of the CVT case where it seals with the sub-assembly side cover.

- A plastic scraper can be used.
- Use ONLY brake cleaner to clean surfaces.
- Clean with a lint-free paper towel.

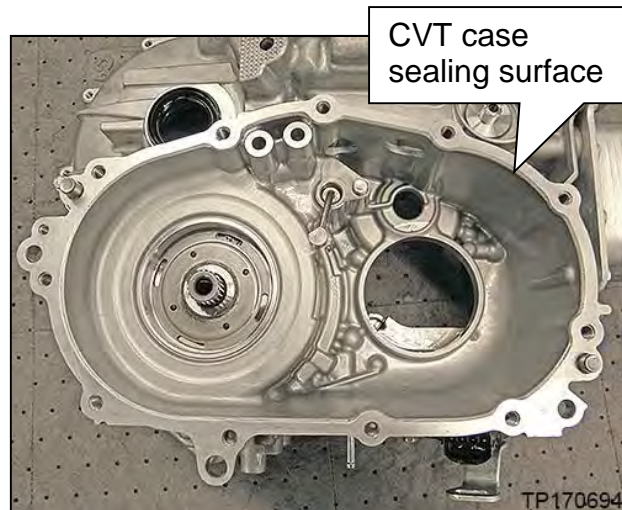

Figure 107

89. Remove any sealant that remains on the sealing surfaces of the torque converter housing and CVT case using a plastic scraper, and then clean with a lint-free paper towel.

- Use ONLY brake cleaner to clean surfaces.

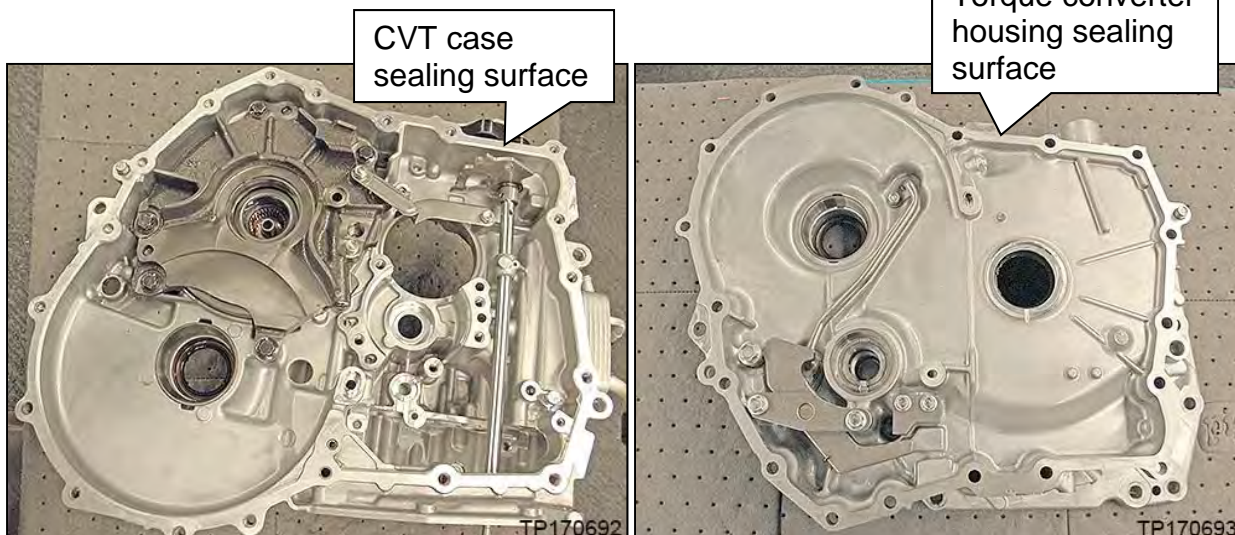

Figure 108

Figure 109

Clean Oil Passages in CVT Case and Oil Pump Cover

In the following steps:

- Brake cleaner and compressed air will be used to clean out oil passages in the CVT assembly.

CAUTION

- To avoid the risk of minor personal injury, wear eye/face protection when using compressed air and cleaning fluids.
- To avoid risk of minor personal injury, regulate air pressure up to a maximum of 75 PSI.

90. Confirm the CVT case is on the work bench with sub-assembly side down.

- Use wood blocks as necessary to stabilize the assembly during these steps.

NOTICE Make sure the surface of the work bench has been cleaned to avoid contamination of components.

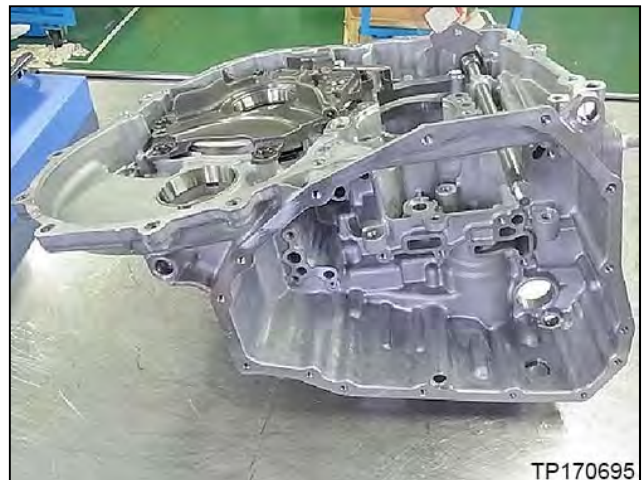

Figure 110

91. Spray brake cleaner into each oil passage of the CVT case, where shown in Figure 111 and Figure 112 with yellow circles, until the fluid runs clear for 5 seconds.

NOTICE To avoid damage to the CVT and potential drivability concerns, do not apply brake cleaner or compressed air to passages shown in red.

92. Apply compressed air in the same passages to remove remaining brake cleaner and debris.

CAUTION To avoid the risk of minor personal injury, do not stand in front of the passages while using compressed air.

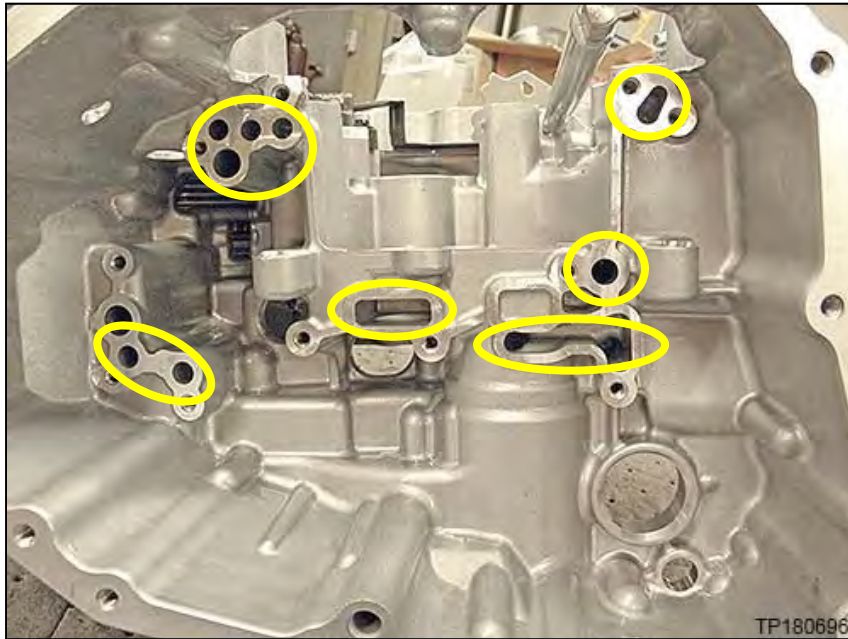

Figure 111

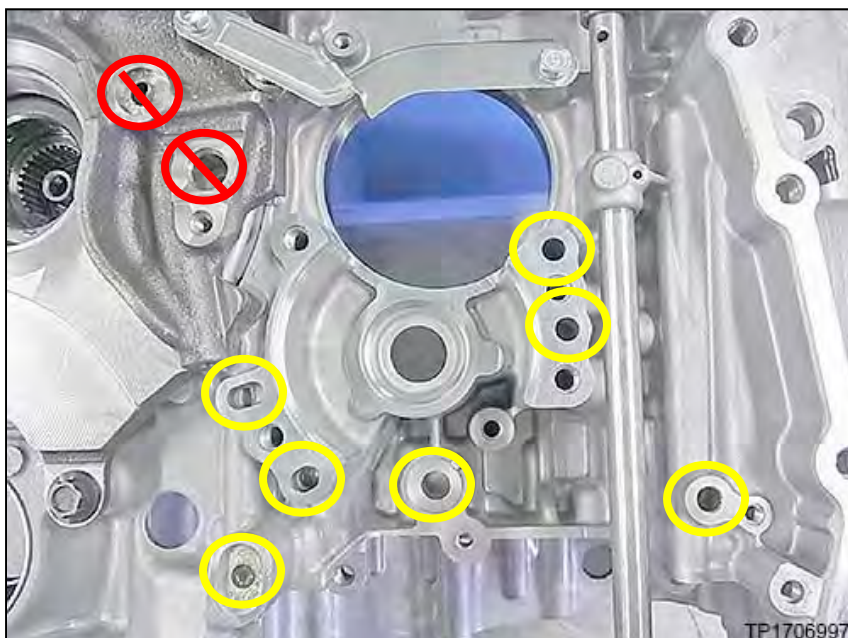

Figure 112

93. Spray brake cleaner into the reverse brake tube.

- Apply compressed air in the same passages to remove remaining cleaner and debris.

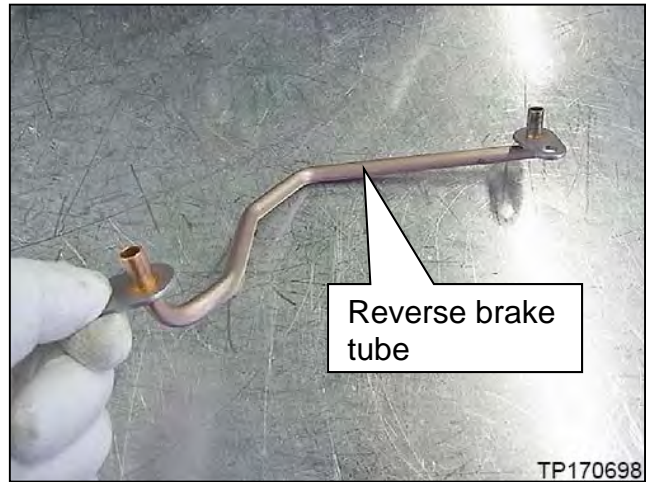

Figure 113

94. Clean the input shaft bearing bore area (Figure 114 and Figure 115).

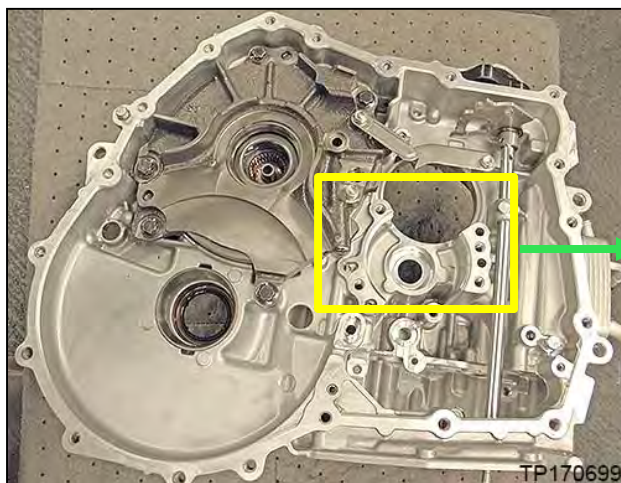

Figure 114

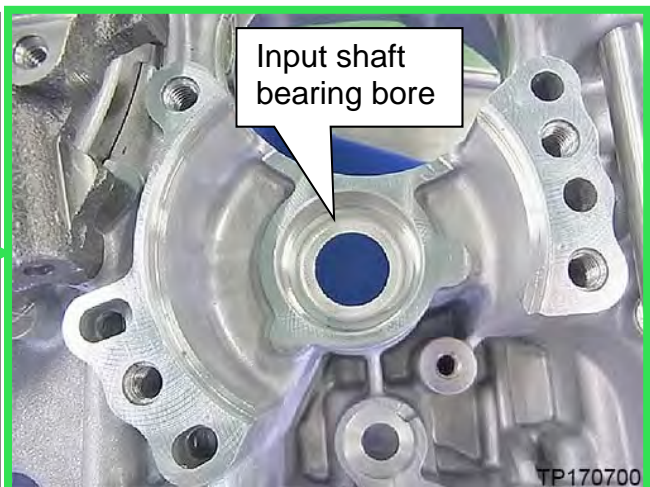

Figure 115

95. Spray brake cleaner into the high clutch fluid passage on the torque converter housing.

CAUTION

- To avoid the risk of minor personal injury, take care when cleaning passages as brake cleaner will exit the passage shown as “fluid discharge” in Figure 116.
- Apply compressed air in the same passages to remove the remaining cleaner and debris.

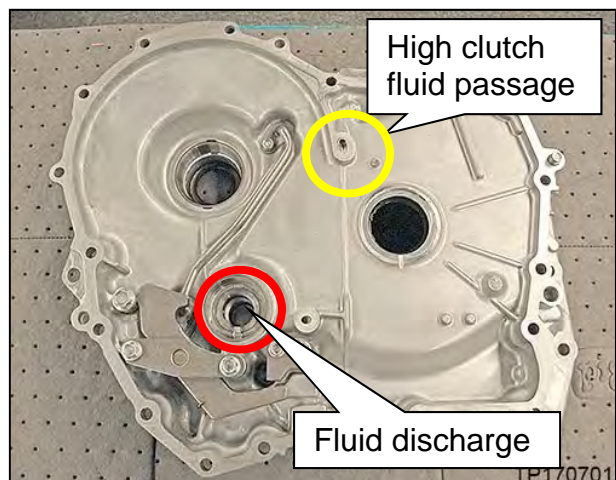

Figure 116

96. Spray brake cleaner into the reduction gear bearing fluid passage on the torque converter housing. Then apply compressed air in the same passages to remove remaining cleaner and debris.

CAUTION

- To avoid the risk of minor personal injury, do not face the passage indicated in red of Figure 117 when cleaning passages as brake cleaner will exit the passage.

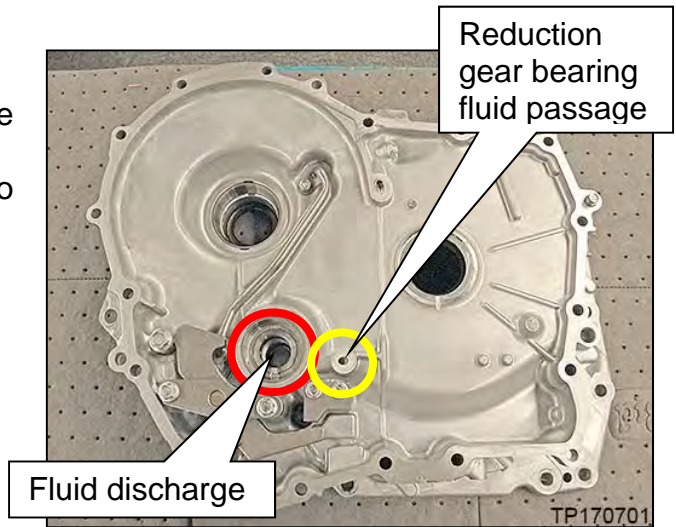

Figure 117

97. Clean the passages of the oil pump cover as follows:

- a. Remove the input shaft from the oil pump cover.

NOTICE

Do not drop the counter bearing outer race (roller bearing type only) as damage or contamination could occur.

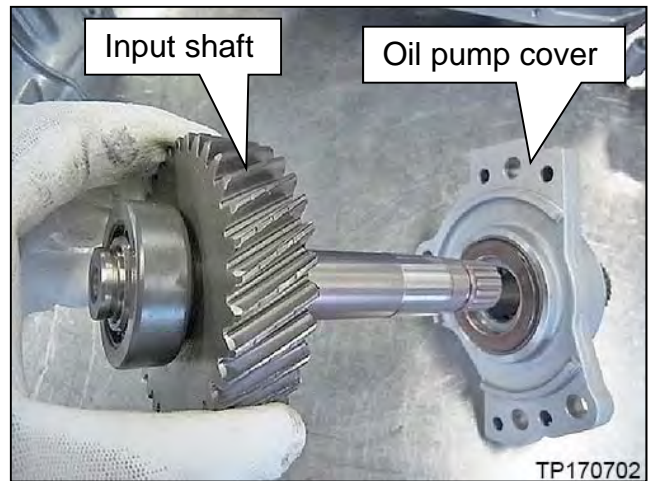

Figure 118

- b. Note the orientation and then remove the thrust bearing.
 - o Do NOT discard. This will be reused at a later step.

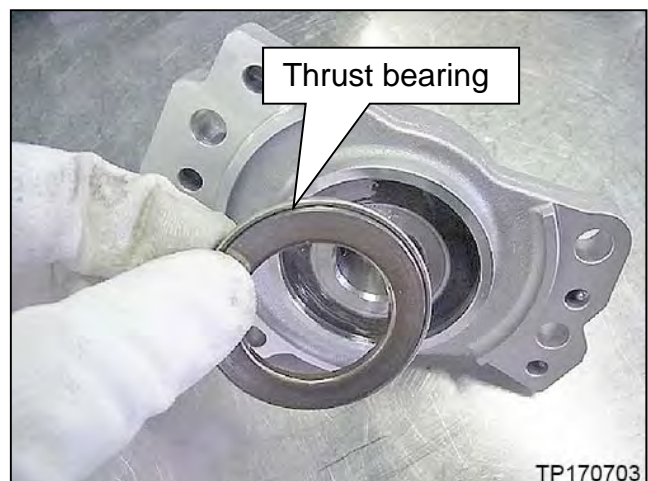

Figure 119

- c. Remove the washer.
 - o Do NOT discard. This will be reused at a later step.
- d. Spray brake cleaner into the oil pump cover oil passages indicated in yellow in Figure 121.
- e. Apply compressed air in the same passages to remove the remaining cleaner and debris.

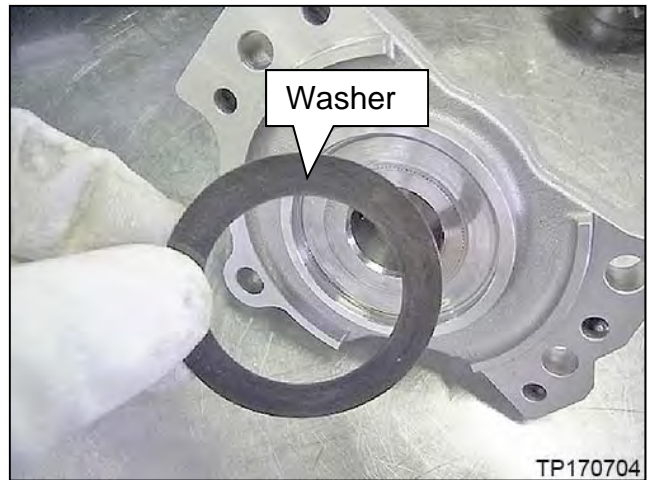

Figure 120

CAUTION

To avoid the risk of minor personal injury, do not face the passage indicated in white in Figure 121 and Figure 122 while cleaning.

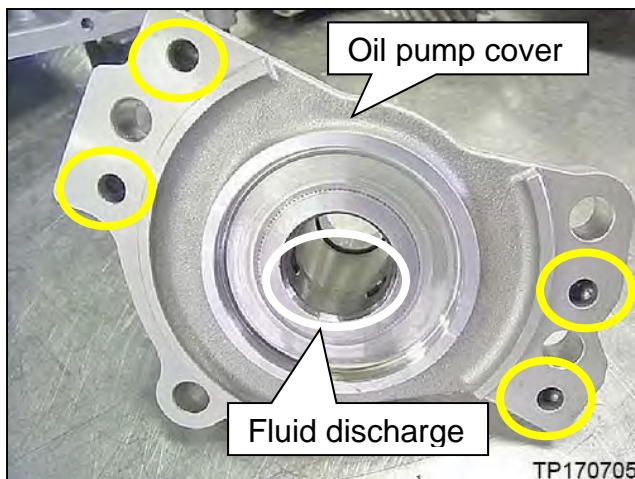

Figure 121

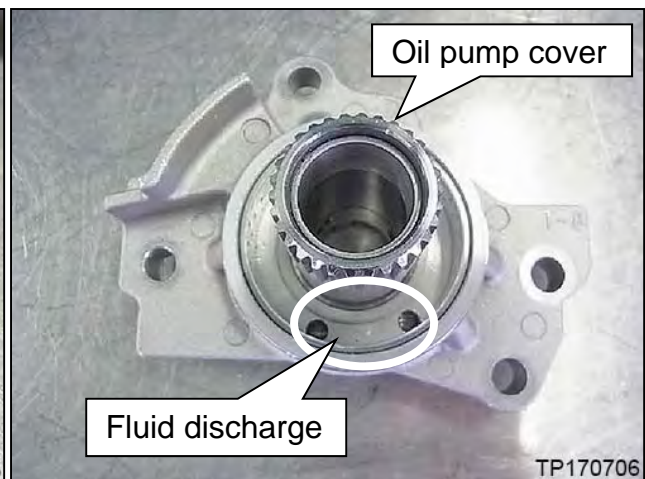

Figure 122

- f. Install the original washer.

HINT:

- Orientation is NOT critical for the washer.
- Apply petroleum jelly to the washer to hold it in place during assembly.

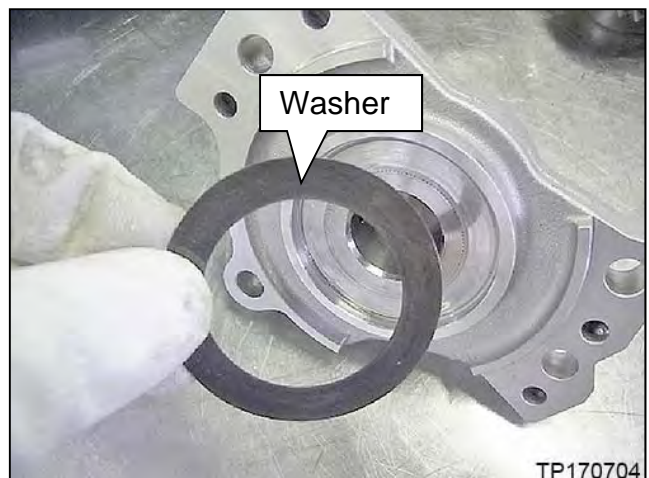

Figure 123

- g. Install the original thrust bearing in the correct orientation as shown in Figure 124 and Figure 125.
- Apply petroleum jelly or equivalent to hold in place.

NOTICE

The thrust washer is direction specific. Install in the correct orientation. If the thrust washer is incorrectly installed, damage to the CVT may occur.

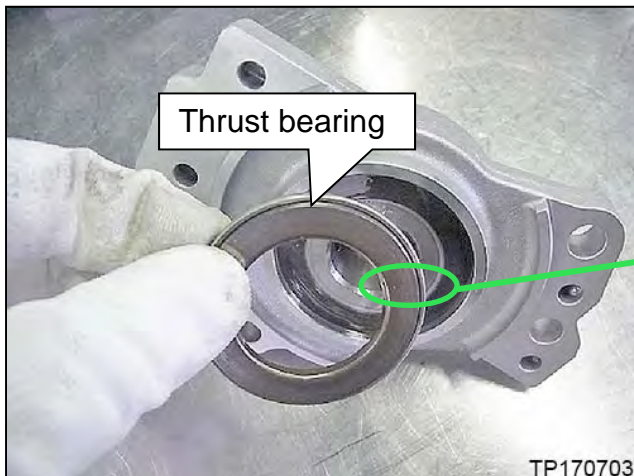

Figure 124

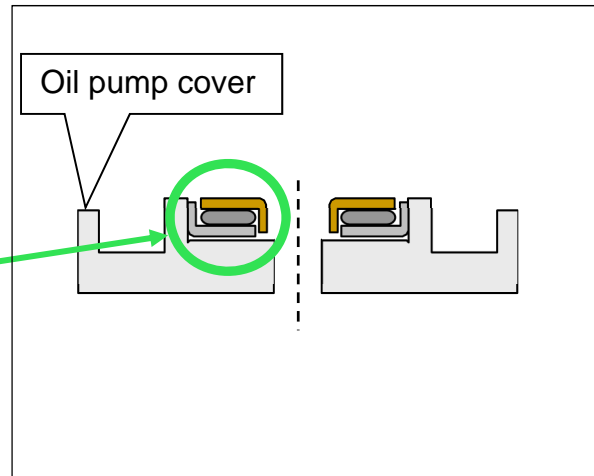

Figure 125

- h. Insert the input shaft into the oil pump cover (Figure 126 and Figure 127).

IMPORTANT:

- Apply petroleum jelly to the sealing ring on the input shaft before installation.
 - The sealing ring is hidden behind the input gear in Figure 126.
- Make sure all exposed internal areas of the CVT (including the oil pan and magnets) have been thoroughly cleaned.

NOTICE

- To avoid damage to the CVT, use care while assembling the input shaft to the oil pump cover as the input shaft sealing ring may become damaged.
- To avoid damage to the CVT when not being worked on, cover all parts with a lint-free covering to prevent contamination.

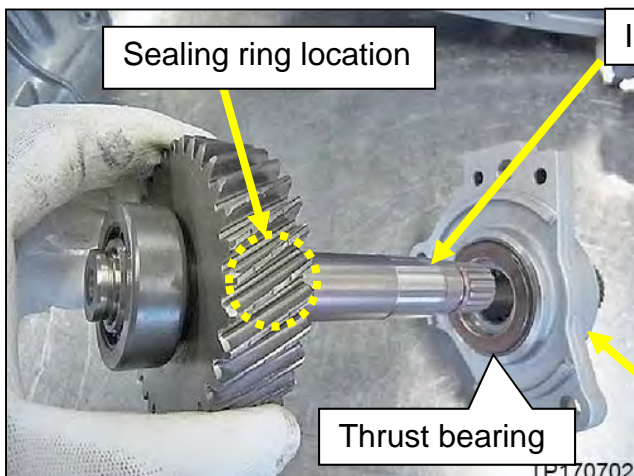

Figure 126

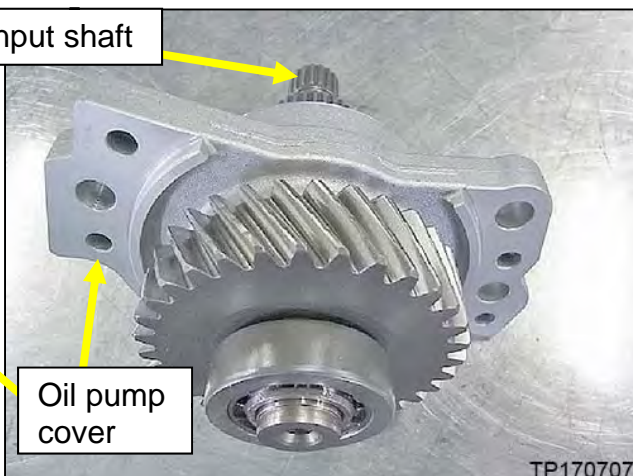

Figure 127

Measuring the CVT Sub-assembly Case Depth

98. Temporarily install the torque converter housing to the CVT case with two (2) bolts at opposite corners, hand tight (Figure 128).

- Use the original bolts to secure.

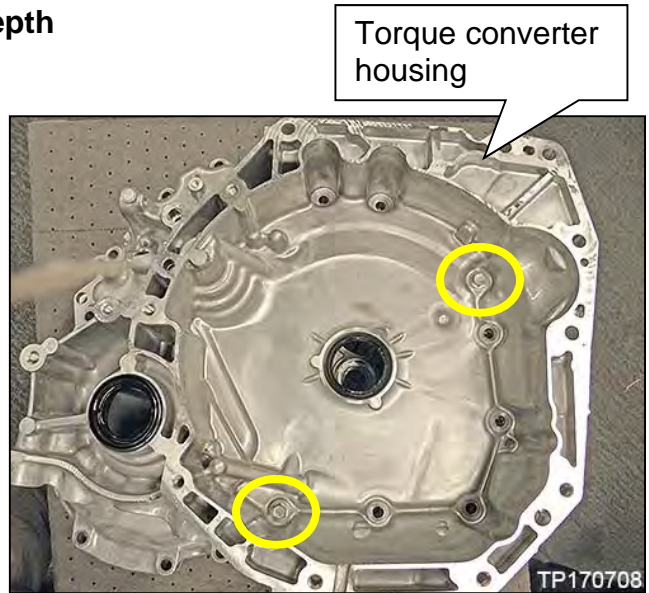

Figure 128

99. Reposition the CVT on the work bench with the torque converter housing side facing down (Figure 129).

100. Clean and then zero the Digital Depth Gauge J-50272.

101. Set the digital gauge to millimeters.

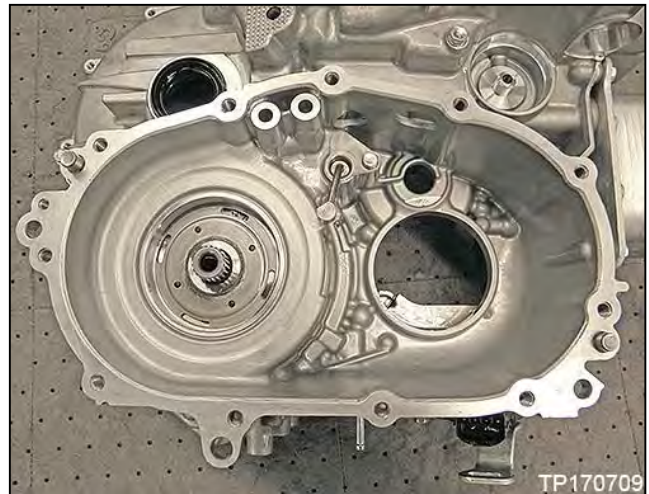

Figure 129

102. Clean the Gauge Block J-50271.

HINT: If Gauge Block J-50271 is not used, the thickness of the substitute gauge block will need to be measured. The thickness of the gauge block is shown as "X" in Figure 133 on page 64.

103. Confirm the sealing surfaces of the CVT case are clean.

104. Place Gauge Block J-50271 across the sub-assembly sealing surface as shown in Figure 130.

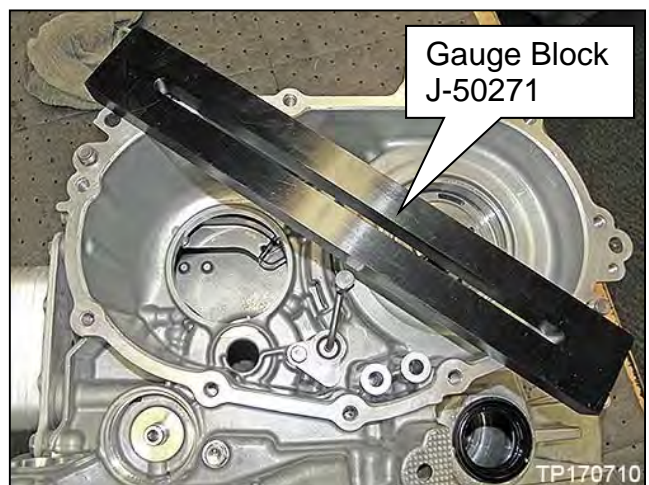
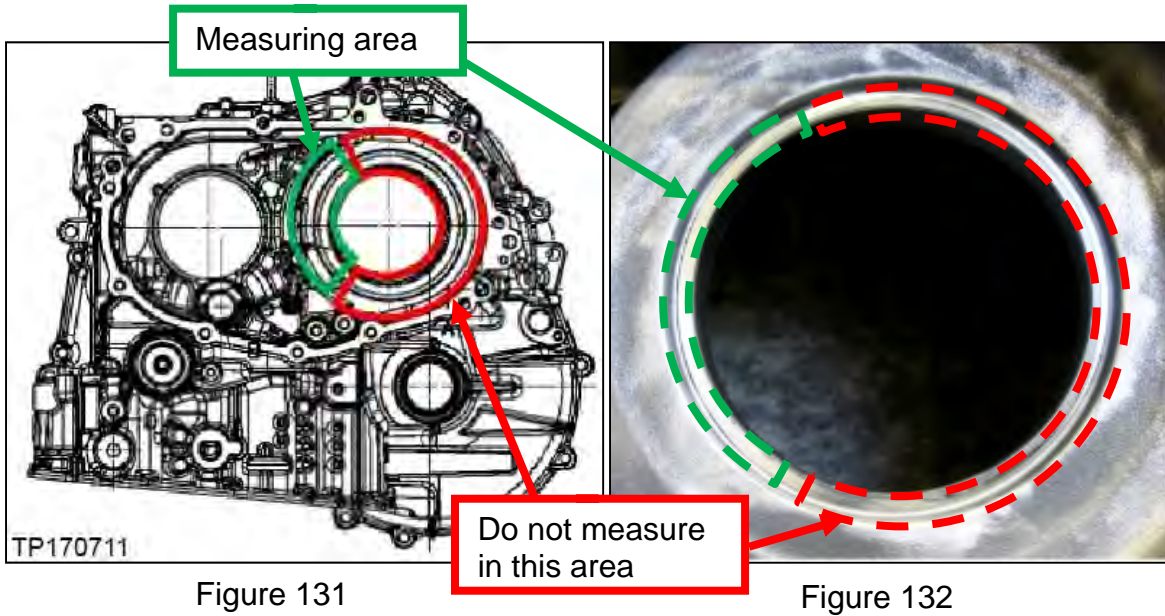

Figure 130

105. Measure the average distance (Y) shown in Figure 133 as follows:

- Refer to Figure 131, Figure 132 and Figure 133, then proceed to page 65.
- Measure only from areas that do not have any signs of contact.
- Refer to “Measuring area” referenced in green to measure “Y”.



Y = The distance between the upper surface of the Gauge Block J-50271 and the surface where the snap ring seats.

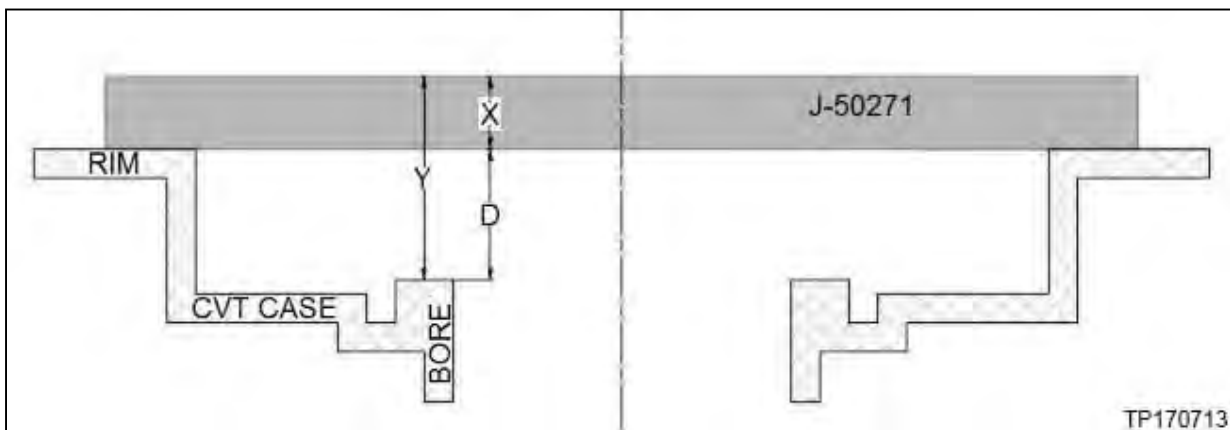

Figure 133

Proceed to the next page.

Secondary pulley bearing snap ring surface

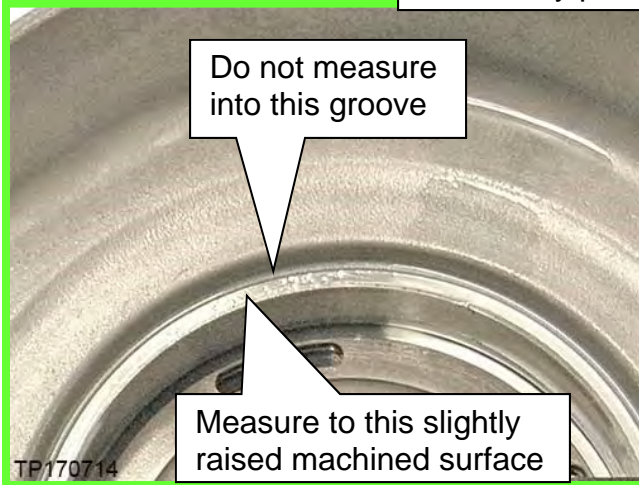

Figure 134

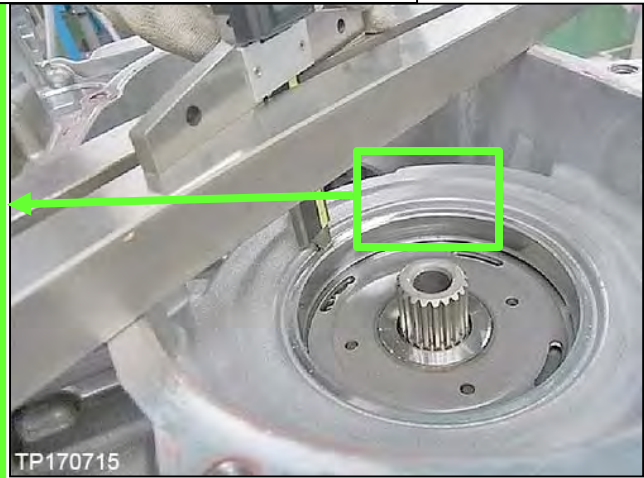

Figure 135

- a. Measure between the top of the Gauge Block (J-50271) to where the snap ring on the secondary pulley bearing seats in three (3) locations to calculate the average value, "Y". Refer to Figure 134 and Figure 135.

Y1 _____, Y2 _____, Y3 _____

- b. Calculate the average, "Y", using the formula below and then record it below.

$$Y = \frac{(Y1+Y2+Y3)}{3} \text{ (millimeter)}$$

Y = _____

- c. Calculate case depth "D" as follows:

IMPORTANT: Essential tool Gauge Block (J-50271) is **20 mm** thick.

- Average depth calculated in step 103b → Y _____
- Subtract the Gauge Block thickness → - X _____
- Calculated depth → = D _____

D = Distance between the sub-assembly sealing surface and the secondary pulley front bearing surface with the snap ring attached.

EXAMPLE:

$$\begin{array}{r} Y = 61.39 \text{ mm} \\ - X = 20.00 \text{ mm} \\ \hline D = 41.39 \text{ mm} \end{array}$$

New Snap Ring Selection and Installation to the New Sub-assembly

106. Remove the top of the shipping box of the new sub-assembly.

HINT: The outer cardboard of the shipping box can be disassembled for easy removal of the sub-assembly by removing the shipping tape.



Figure 136

107. Remove the upper board with foam spacer assembly.

- The packing material may be different then what is shown in Figure 137.

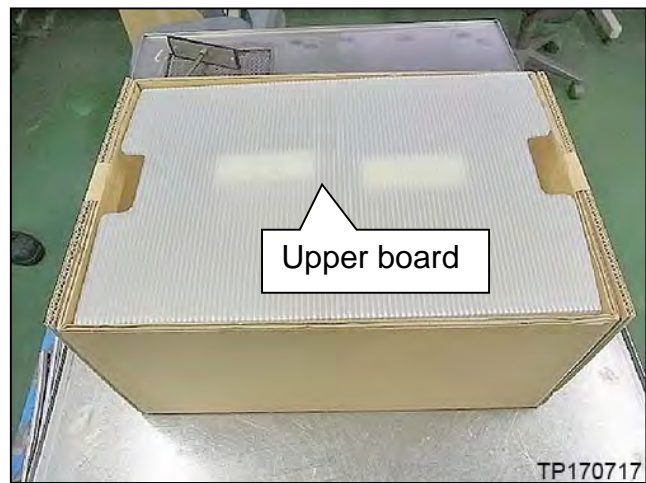

Figure 137

108. Locate the data sheet in the shipping box and place it in a safe place.

- This data sheet is required for snap ring selection in the following steps.

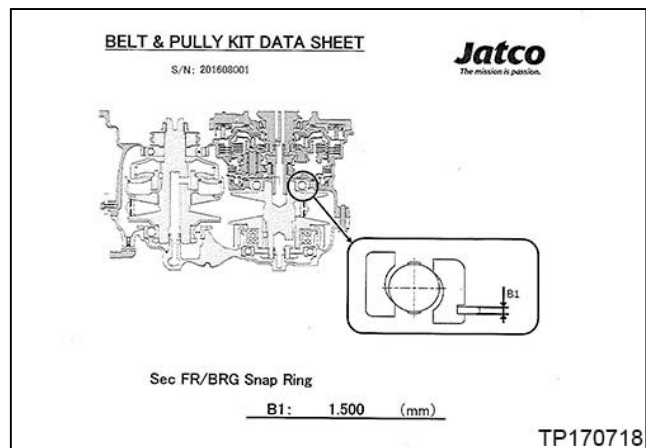

Figure 138

109. Locate the plastic bag that contains the snap rings (Figure 139).

- There are six individual snap rings in the plastic bag.
- Take the plastic bag out of the shipping box, and put aside on the work bench.

HINT: See Reference # 5 in the **KIT PARTS REFERENCE TABLE**.



Figure 139

110. Take the new sub-assembly out of the shipping box and place it on the work bench.

NOTICE To avoid possible damage to the CVT:

- Hold the sub-assembly by the side cover **ONLY** when removing it from the shipping box.
- **DO NOT** handle the belt or pulleys of the sub-assembly when removing from the shipping box.
- **DO NOT BREAK** the foam cushion in the shipping box. This will be used as a stabilizer for the sub-assembly during the repair.



Figure 140

HINT: See Reference # 4 in the **KIT PARTS REFERENCE TABLE**.

111. Take the lower board with foam cushion (lower board) out of the shipping box shown in Figure 142.

HINT: Step 112 is for kits that have a separate spacer (Figure 141). In later kits this spacer will be part of the lower board and step 112 will not be used.

112. Take the spacer (Figure 141) out of the shipping box and place on the work bench where the sub-assembly will be installed, and then place the lower board on top of the spacer as shown in Figure 142.

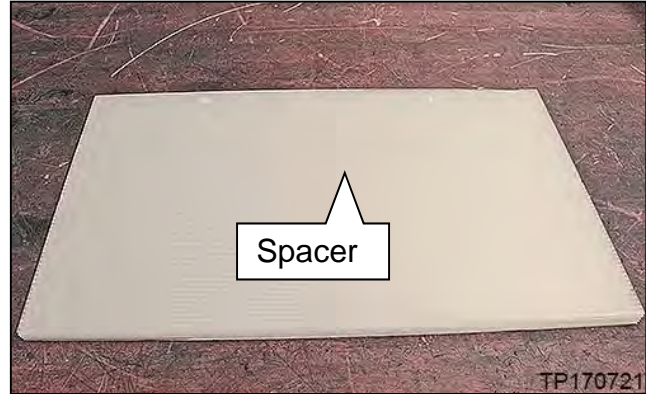

Figure 141

HINT: The spacer will be the last item that is removed from the shipping box and is approximately 1 inch thick.

- Position the lower board so that it hangs over the spacer.
- Align the lower board so that the left and the right cut-outs are even with the spacer.

NOTE: The positioning of the lower board with foam cushion will allow the CVT case enough clearance from the work bench to allow it to seat flush with the sub-assembly.

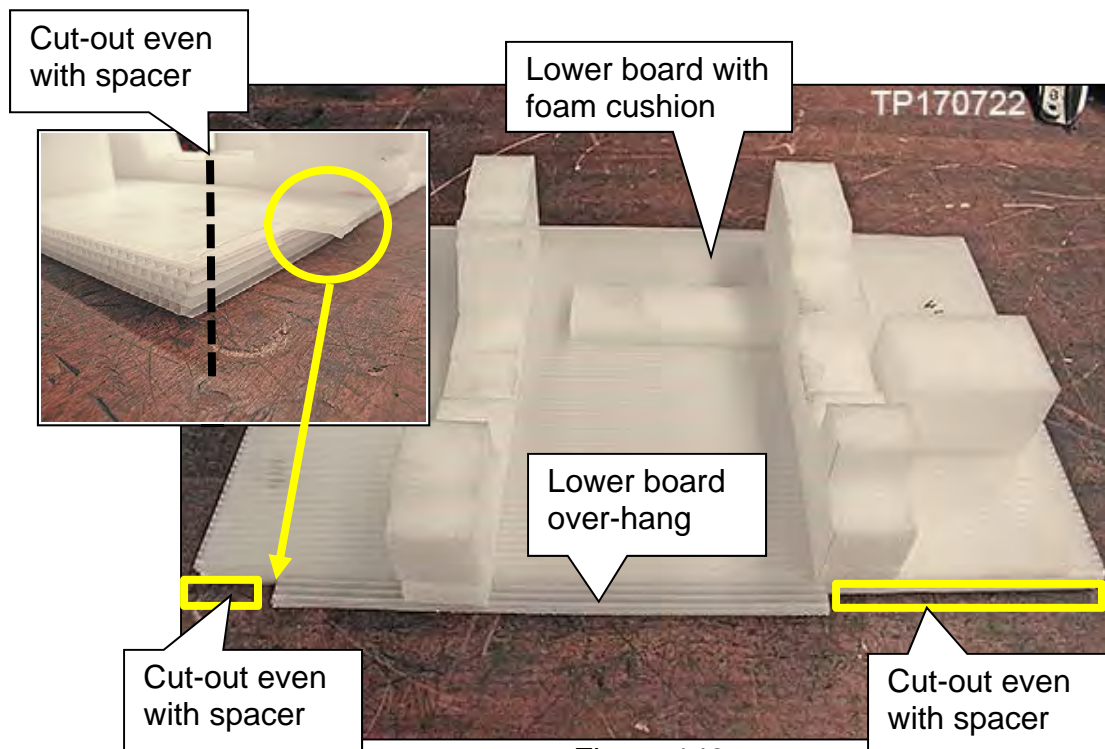
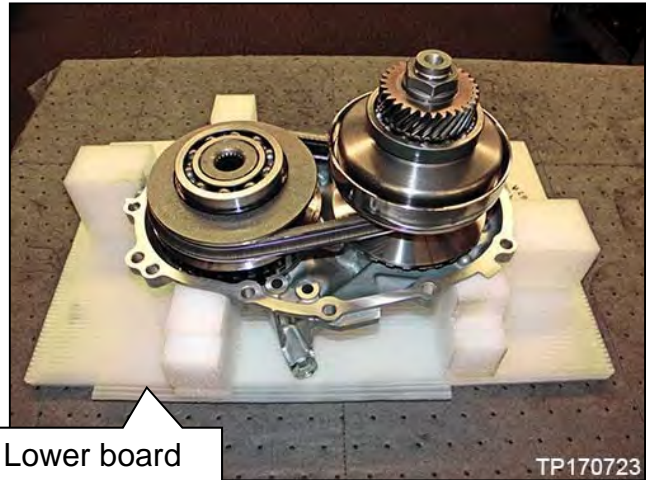

Figure 142

113. Remove the sub-assembly from the plastic bag.

114. Place the new sub-assembly onto the lower board.

- The sub-assembly must be level and oriented as shown in Figure 143 for proper seating of the CVT case later in this procedure.



Lower board and spacer

Figure 143

115. Remove the snap ring from the secondary pulley front bearing of the new sub-assembly.

- A new snap ring will be installed later in the procedure.

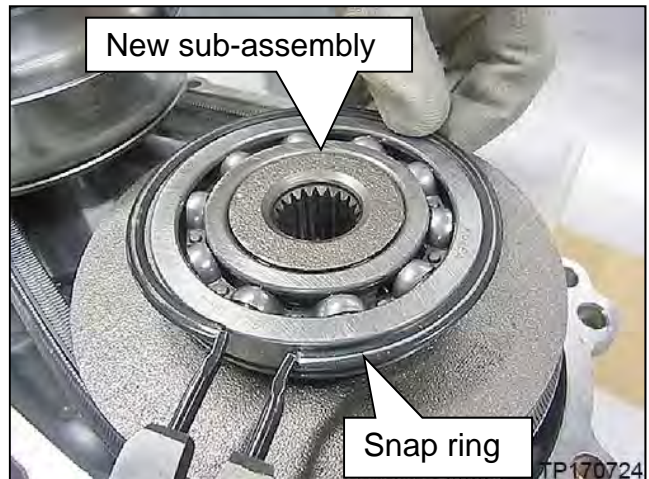

New sub-assembly

Snap ring

Figure 144

116. Calculate “E” for snap ring selection as follows:

HINT: For the value of “B1”, refer to the data sheet that was put aside when the sub-assembly shipping box was opened.

- Calculated case depth from step c on page 65 → **D** _____
- Subtract constant value → **− 41.30**

- Subtotal → **=** _____
- Add value for “B1” from data sheet → **+ B1** _____

- Total calculated depth → **= E** _____

E = This will be used to select a snap ring from **Table A** on page 71.

EXAMPLE:

If D = 41.39 mm
Constant = 41.30 mm (subtracted)
And B1 = 1.56 mm (added)

E = 1.65 mm

117. Select the appropriate Part Number from **Table A** shown below, based on the calculated result of “E” in step 116 on page 70.

EXAMPLE: If $E = 1.65$, and is between or equal to **1.64 to 1.67**, choose new snap ring Part Number “**31506 3JX9C**”.

E (MM)	PART NUMBER	SNAP RING REFERENCE (MM)
1.55 to 1.59	31506 3JX9A	1.61
1.60 to 1.63	31506 3JX9B	1.65
1.64 to 1.67	31506 3JX9C	1.69
1.68 to 1.71	31506 3JX9D	1.73
1.72 to 1.75	31506 3JX9E	1.77
1.76 to 1.76	31506 3JX8A	1.79

Example only. Do not use in your calculations.

Table A

E (MM)	PART NUMBER	SNAP RING REFERENCE (MM)
1.55 to 1.59	31506 3JX9A	1.61
1.60 to 1.63	31506 3JX9B	1.65
1.64 to 1.67	31506 3JX9C	1.69
1.68 to 1.71	31506 3JX9D	1.73
1.72 to 1.75	31506 3JX9E	1.77
1.76 to 1.76	31506 3JX8A	1.79

118. Open the plastic bag (with snap rings) that was removed from the shipping box in step 109 on page 67 and then choose the correct Part Number selected from **Table A**.

HINT: There are six individually packed snap rings in the plastic bag. See Reference # 5 in the **KIT PARTS REFERENCE TABLE**.

119. Measure the new snap ring and confirm its thickness is equal to the Snap Ring Reference in **Table A**.

120. Install the selected snap ring onto the secondary pulley front bearing of the new sub-assembly.

HINT: Discard unused snap rings.



Figure 145



Figure 146

Install Sub-assembly to CVT Case

121. Make sure the CVT case sealing surface of the side cover is thoroughly cleaned.
122. Make sure the dowel pins are cleaned and any rust has been removed.

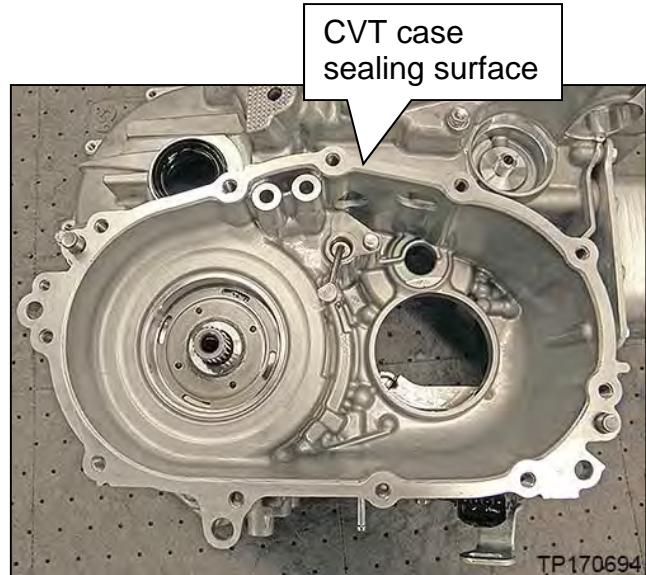

Figure 147

123. Flip the CVT case over on the work bench with the torque converter housing side facing up.

NOTICE To avoid possible contamination and damage to the CVT, ensure the work bench surface is thoroughly cleaned before flipping the CVT case.

124. Remove the two (2) temporary bolts and then remove the torque converter housing from the CVT case.

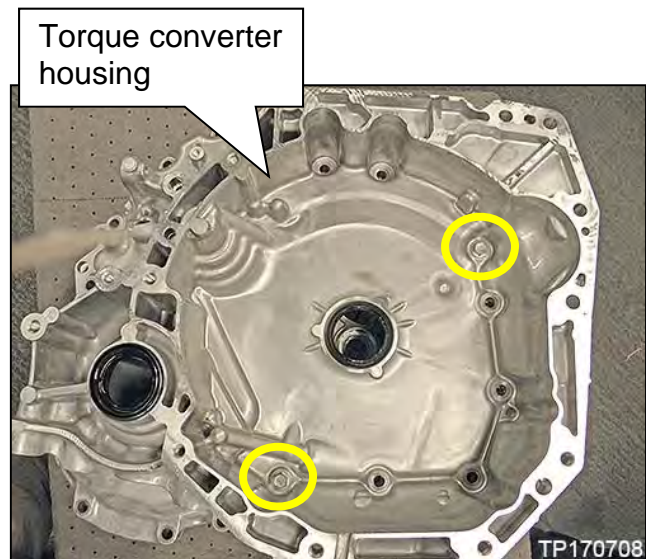

Figure 148

125. Install the CVT case onto the new sub-assembly as follows:

NOTE: Sealant will be applied between these components at a later step.

a. Slowly lower the CVT case onto the sub-assembly.

NOTICE To avoid damage to the CVT:

- Only use the weight of the CVT case when installing it to the sub-assembly.
- Do NOT use any other external force to seat the CVT case to the sub-assembly.

b. Align the primary pulley front bearing bore of the CVT case to the primary pulley front bearing of the sub-assembly.

HINT: Figure 150 is shown looking down into the CVT case while it is being lowered.

c. Align one of two dowel pin holes found on the CVT case to the sub-assembly.

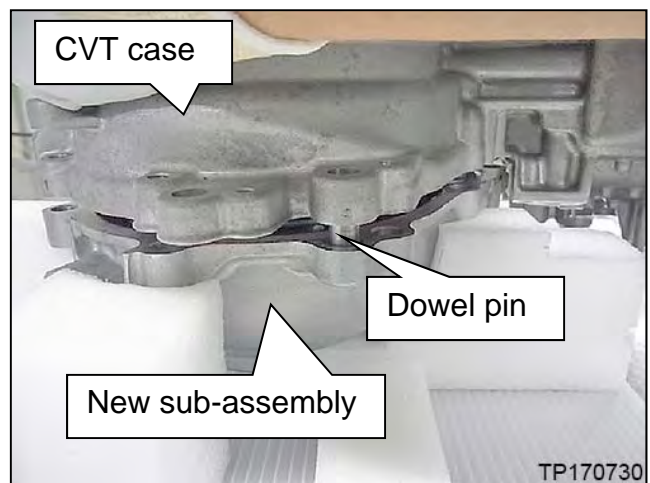
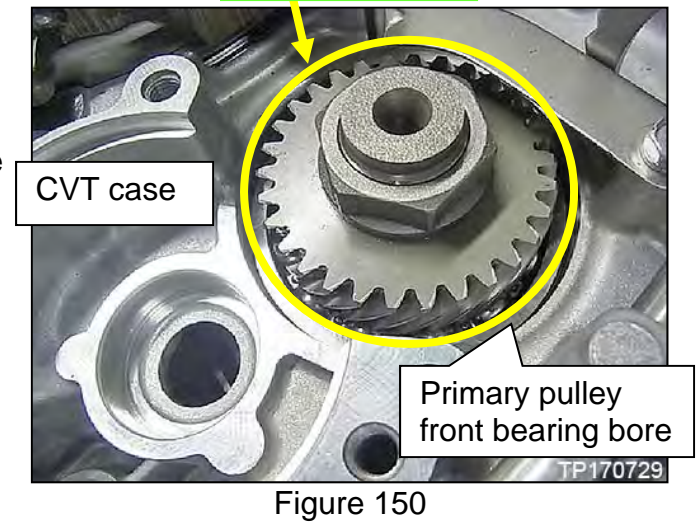
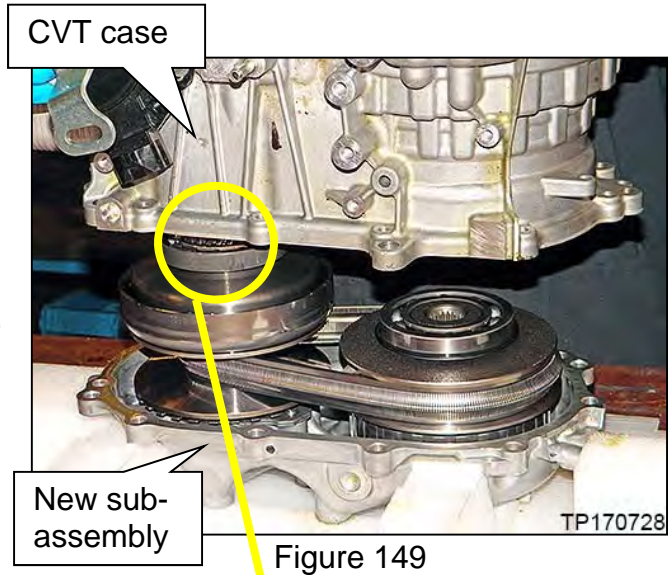

- d. Align the second dowel pin of the sub-assembly with the hole on the opposite side of the CVT case and seat CVT case.

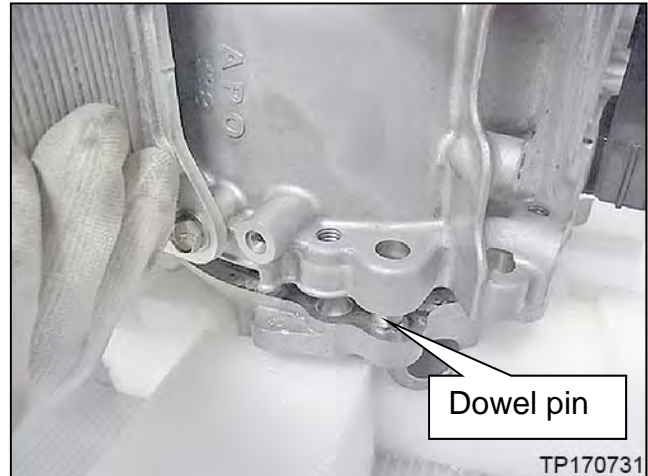

Figure 152

- e. If the CVT case will not seat on the sub-assembly:

- 1) Access the counter driven gear through the top of the CVT case, **and**
- 2) Rotate the counter driven gear on the primary pulley back and forth.

HINT: This will allow the splines of the secondary pulley and the planetary carrier plate to align. See Figure 154.

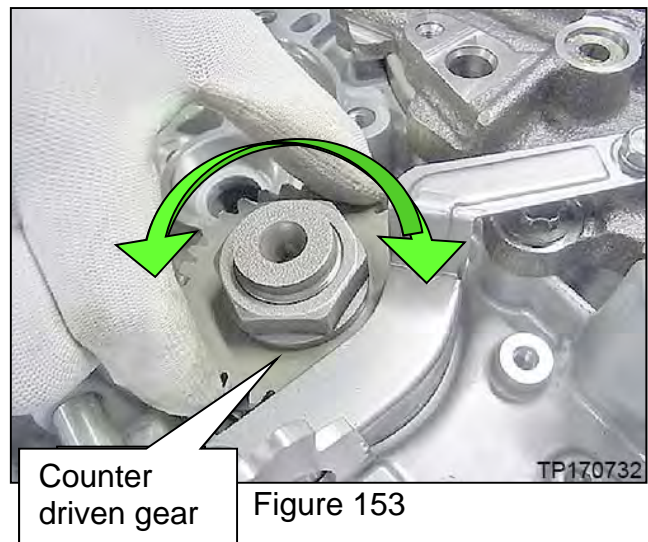

Figure 153

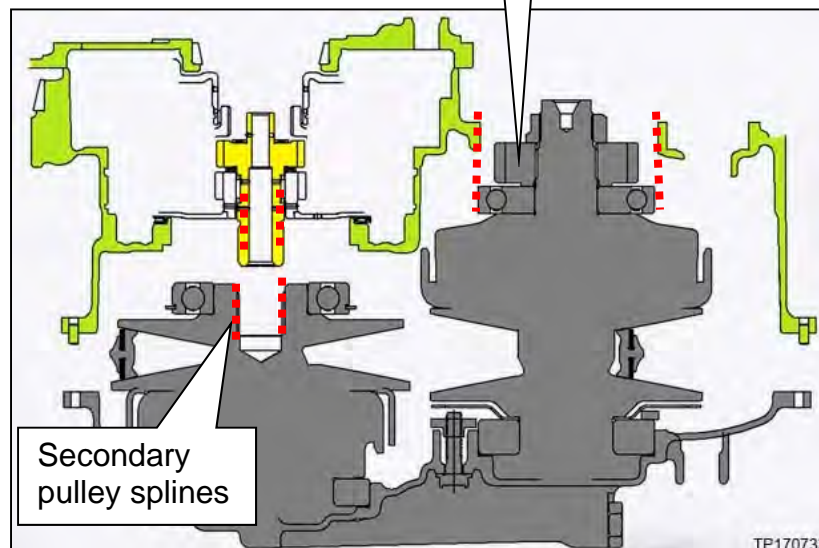

Figure 154

- f. Confirm that the mating surface of the CVT case is seated to the sub-assembly completely.
- If the CVT case does not sit completely flush with the sub-assembly, DO NOT apply any vertical force to seat it.
 - 1) If this occurs, first lift the CVT case up slightly and then lower.
 - 2) Repeat until the CVT case and sub-assembly sit flush with each other.

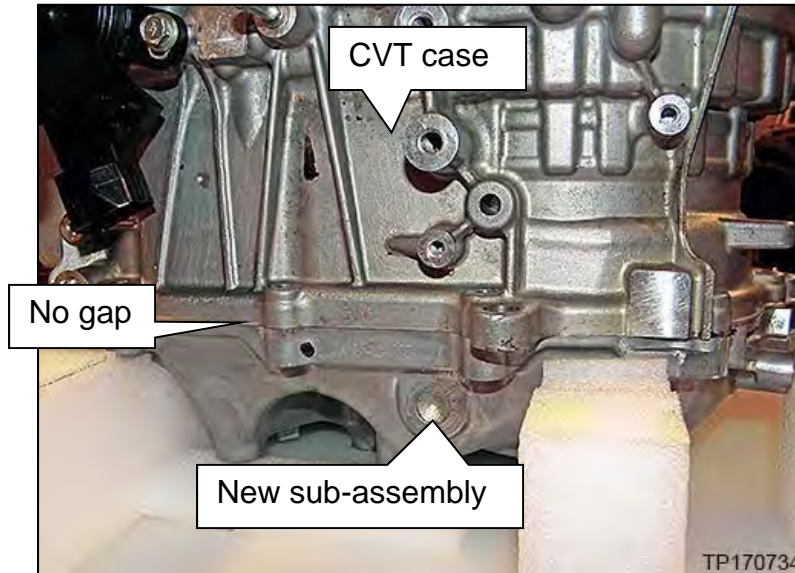

Figure 155

- g. Rotate the counter driven gear back and forth by hand to confirm its rotation is smooth.

126. Temporarily install two (2) original bolts hand tight to hold the sub-assembly to the CVT case.

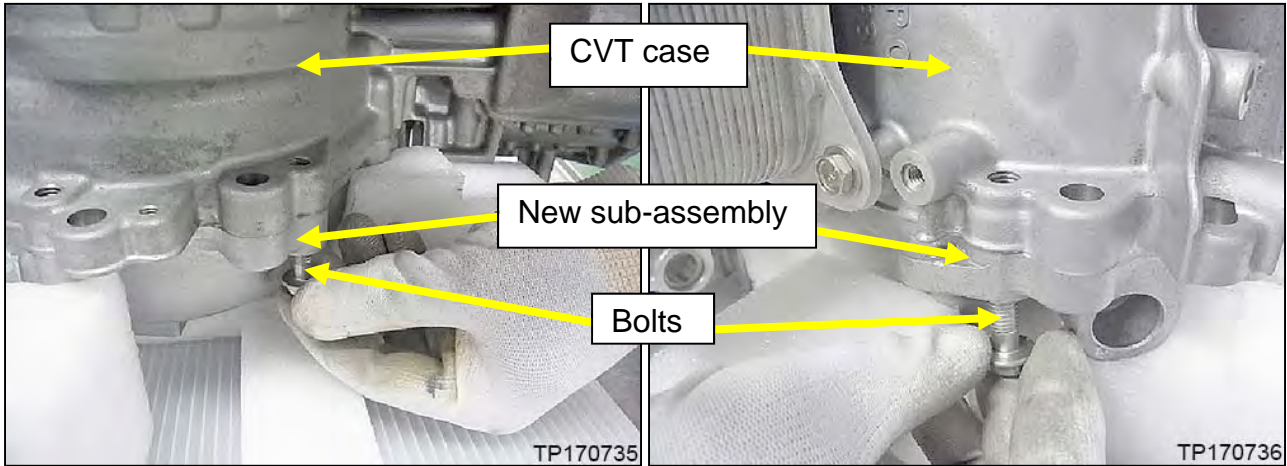

Figure 156

Figure 157

127. Lift the sub-assembly / CVT case away from the cradle and set aside. Discard the cradle.

- Leave the sub-assembly side cover facing down as shown in Figure 158.
- Weight: 29 kg (64 lbs.)

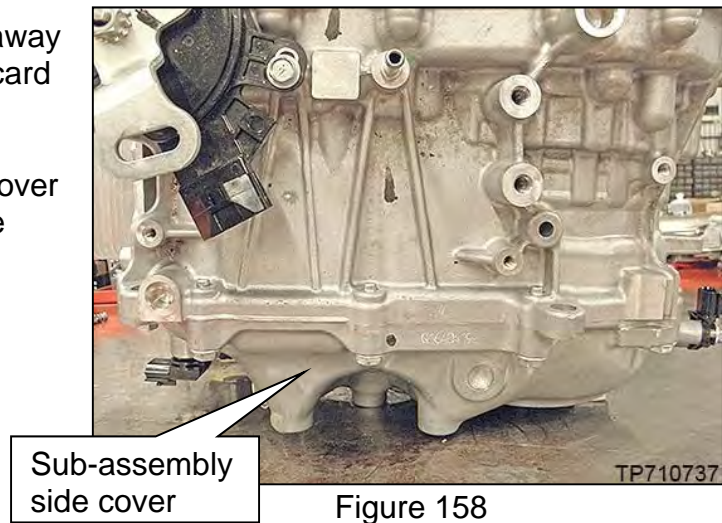

Figure 158

Install the Oil Pump and the Manual Shaft

128. Install the oil pump gasket to the CVT case.

- Use a new gasket (non-reusable).
- Apply CVT fluid before installation.

HINT: See Reference # 14 in the **KIT PARTS REFERENCE TABLE**.

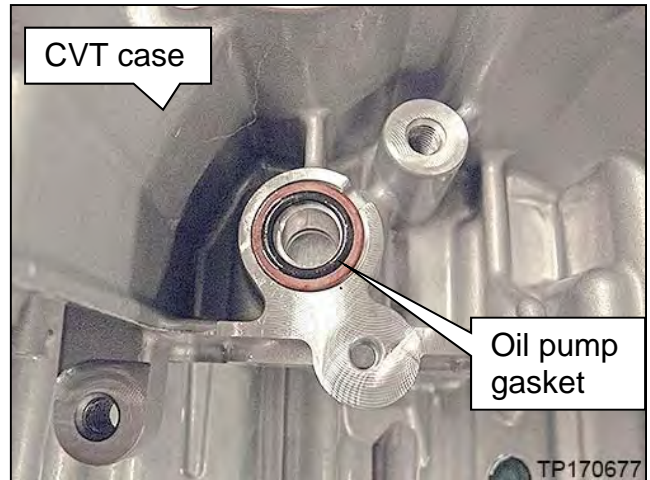

Figure 159

129. Remove the hand tight transmission range switch bolts and then slide the manual shaft out only far enough to install the oil pump. See Figure 90 on page 48.

NOTICE

- Do not remove the manual shaft completely from the CVT case. If the retaining pin slot contacts the seal, damage may occur.

130. Install a new oil pump to the CVT case.

- Reuse the three original Allen® bolts for the oil pump.
- 35 mm (1.4 inches) long bolt.
 - Bolt torque: 20.3 N•m (2.1 kg-m, 15 ft-lbs.)

HINT: See Reference # 13 in the **KIT PARTS REFERENCE TABLE**.

131. Install the snap ring that came out of the original oil pump to the new oil pump.

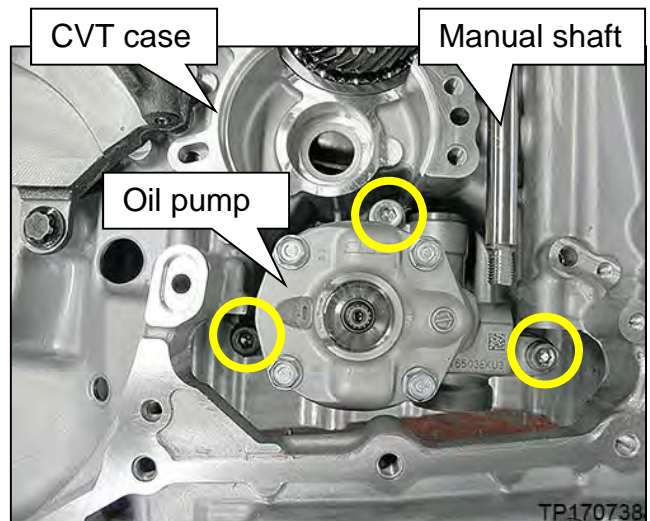

Figure 160



Figure 161

132. Slide the manual shaft back to the original position.

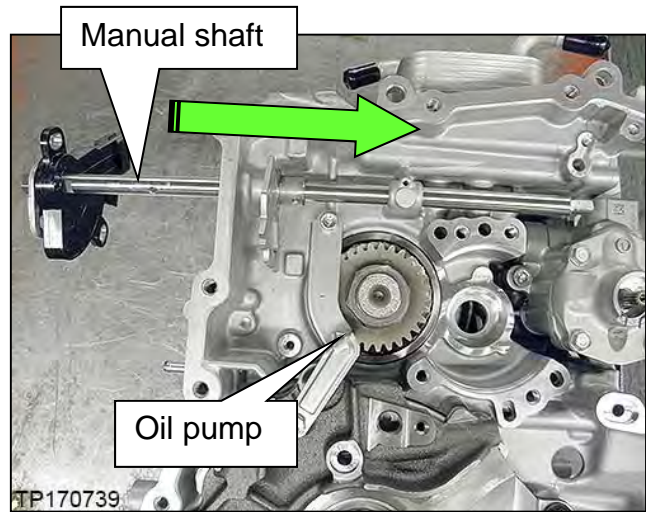

Figure 162

133. Install the original retaining pin as shown in Figure 163.

- Align the manual shaft groove (Figure 164) to allow the retaining pin (Figure 163) to go through completely.

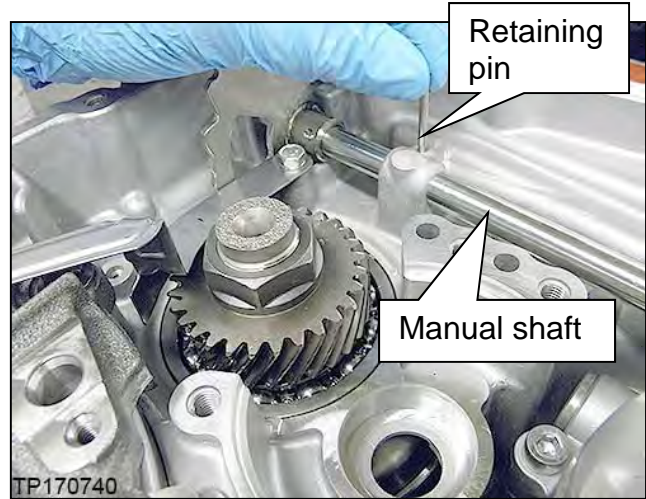
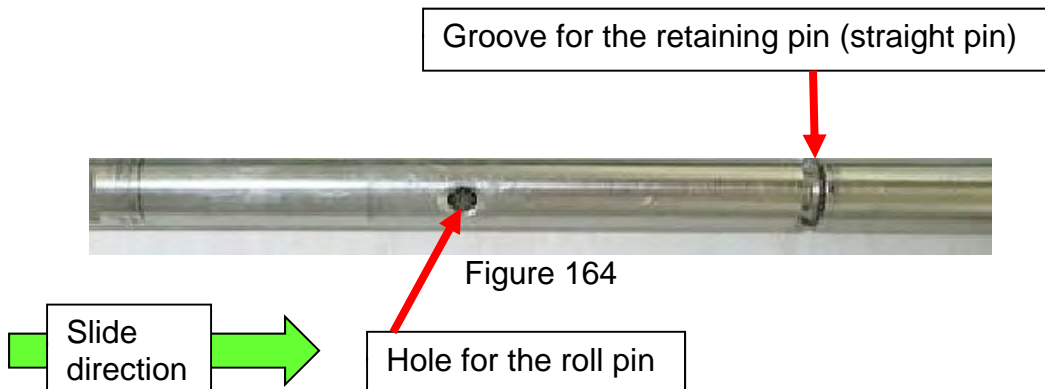

Figure 163



NOTICE

To prevent CVT operational issues, use care when assembling the manual shaft and detent plate.

- Do not drive the roll pin flush with the detent plate.
- If the roll pin is driven flush, it will be overextended on the opposite side and the manual shaft/detent plate assembly will not rotate.
- The roll pin MUST be the same length on both sides of the detent plate after it is installed through the detent plate and manual shaft.

134. Install the new roll pin through the detent plate and manual shaft.

- The roll pin must be inserted through the detent plate so that both ends are the same length.
- Use a new roll pin (non-reusable).
- Punch size: Diameter 3 mm, Length 20 mm or longer.

NOTICE Use the appropriate size punch to prevent damage to the roll pin or detent plate.

HINT: See Reference # 12 in the **KIT PARTS REFERENCE TABLE**.

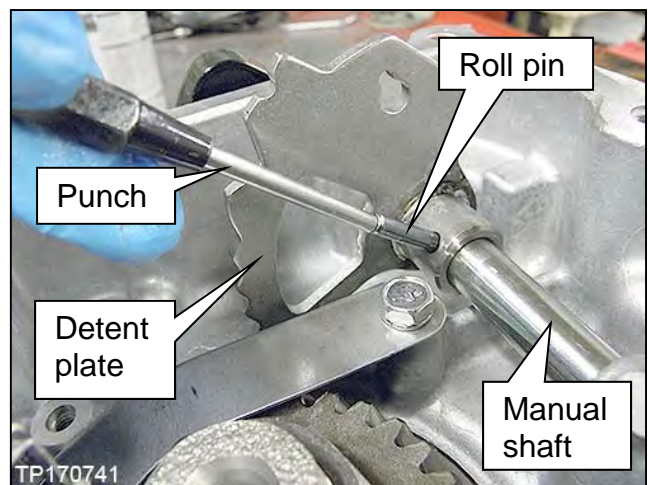

Figure 165

Install Powertrain Parts

135. Install the original manual shaft detent spring to the CVT case.

IMPORTANT: Locate the tab of the detent spring to the hole of the CVT case.

- 16 mm (**0.6 inches**) long bolt.
 - Bolt torque:
6.8 N•m (0.70 kg-m, **60 in-lbs.**)

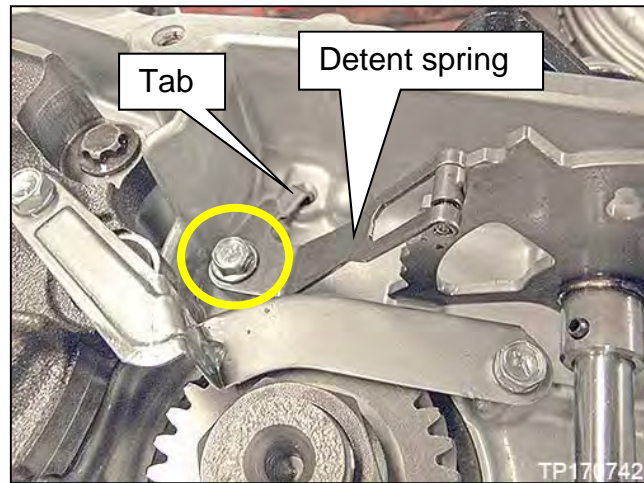

Figure 166

136. Install the original shim for the input shaft in the counter bearing bore (Figure 167).

- If the counter bearing is a type "A" (roller bearing) continue to step 137 on page 81.
- If the counter bearing is a type "B" or "C" (ball bearing) skip to step 139 on page 81.

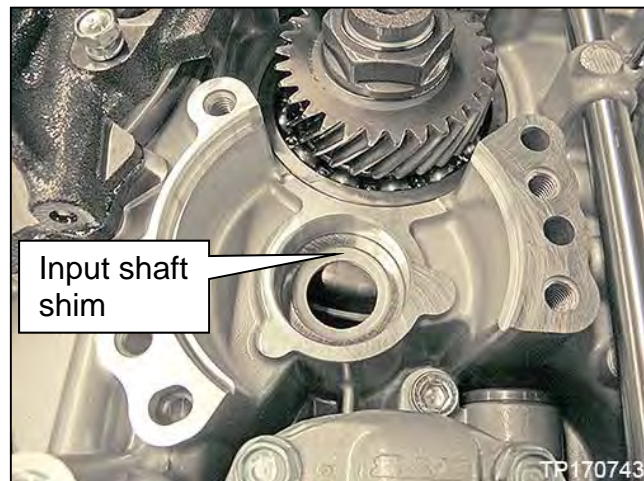

Figure 167

NOTE: Type "C" counter bearing shown in Figure 168. Type "B" is similar.

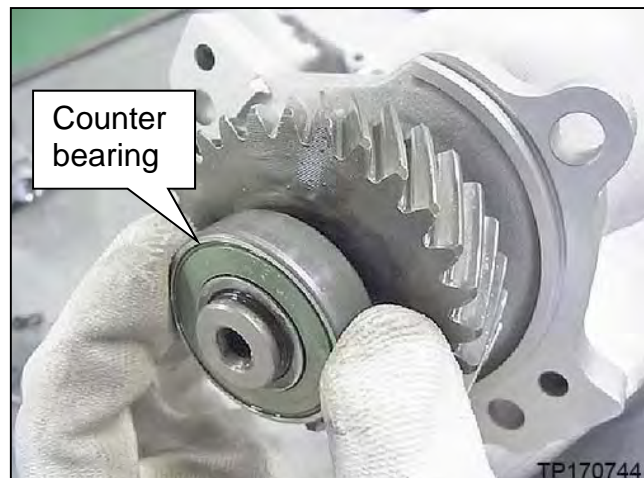

Figure 168

137. For type “A” bearings, install the outer race of the roller bearing to the counter bearing bore of the CVT case, if it has not been done already.

IMPORTANT: Apply CVT Fluid to the outer race of the roller bearing before installation.

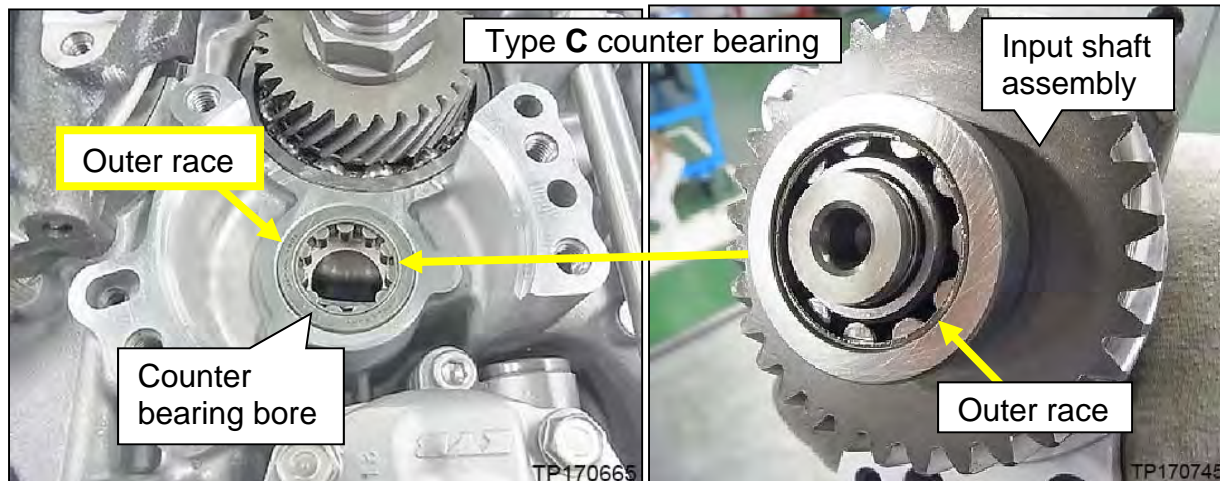

Figure 169

Figure 170

138. If the input shaft assembly is, for any reason, separated into individual components, see steps 97f- 95h on pages 60 - 62 to reassemble those parts, otherwise continue to step 139.

139. Install the input shaft assembly to the CVT case

- Hold the tip of the input shaft so that the input shaft and the pump cover remain together.
- Confirm that the oil pump cover seats onto the CVT case completely.

NOTICE Do not draw the input shaft assembly down to the case with the mounting bolts or damage to the CVT may occur.

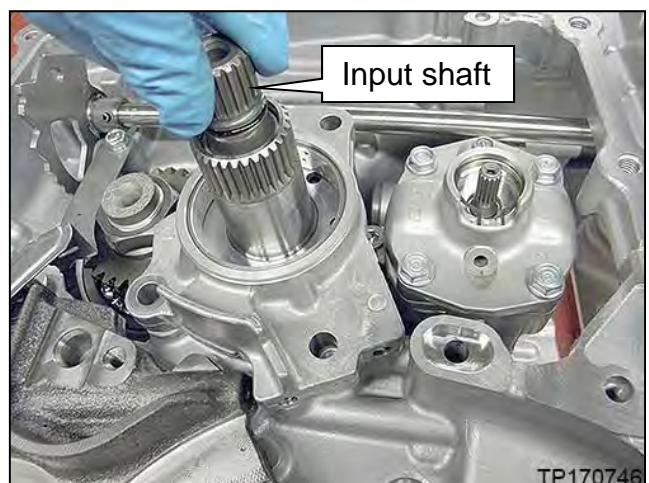

Figure 171

140. Install the original chain cover and the six (6) original bolts and then tighten.

- 16 mm (**0.6 inches**) long bolt
2 pieces.
 - Bolt torque:
5.6 N•m (0.60 kg-m, **50 in-lbs.**)
- 30 mm (**1.2 inches**) long bolt
4 pieces.
 - Bolt torque:
27.1 N•m (2.8 kg-m, **20 ft-lbs.**)

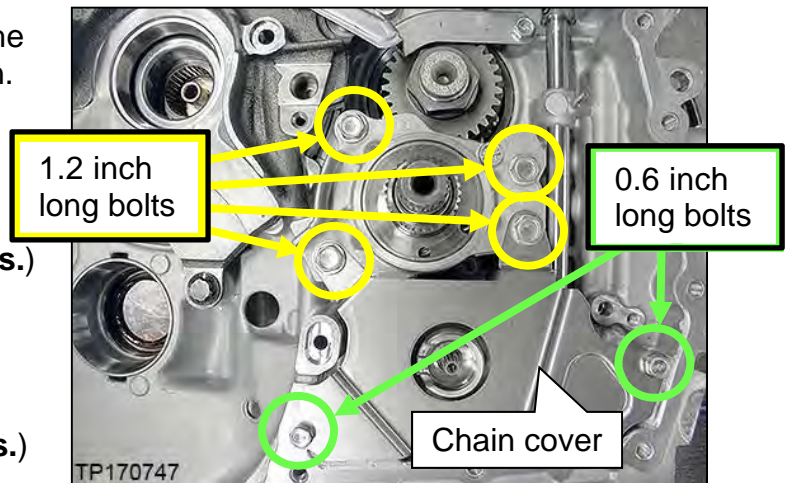

Figure 172

141. Rotate the input shaft by hand to confirm that the shaft rotates freely.

142. Install the sleeve to the reverse brake tube.

- Use a new sleeve (non-reusable).
- Apply CVT Fluid to the sleeve before installation.

HINT: See Reference # 20 in the **KIT PARTS REFERENCE TABLE.**

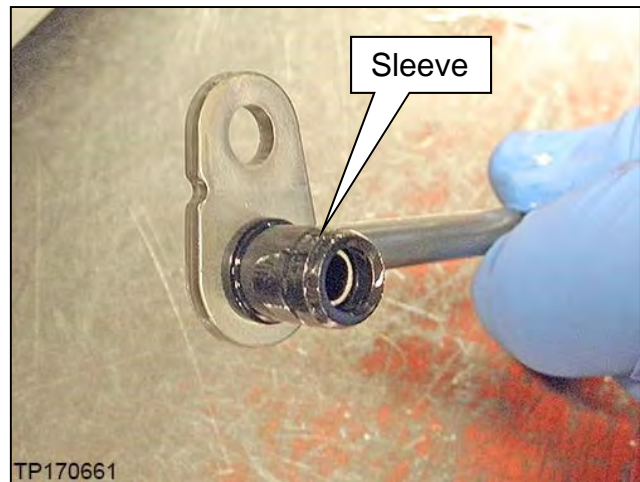

Figure 173

143. Install the reverse brake tube to the CVT case.

- 16 mm (**0.6 inches**) long bolt.
 - Bolt torque:
5.6 N•m (0.60 kg-m, **50 in-lbs.**)

NOTICE Insert the tube to the CVT case vertically and evenly to avoid damage to the sleeve.

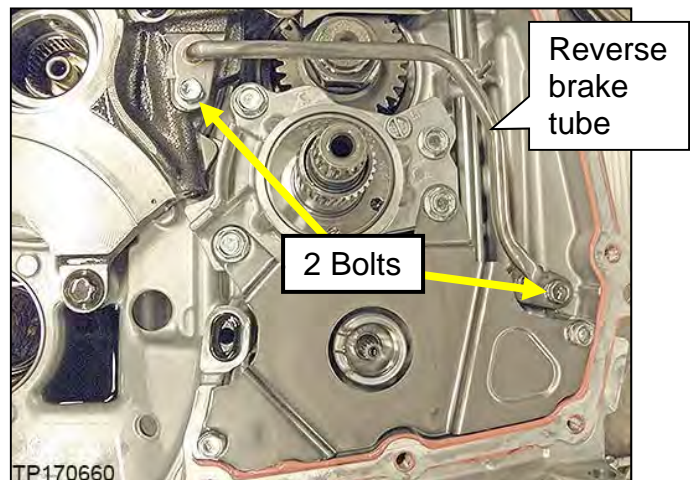

Figure 174

144. Connect the parking rod to the detent plate as shown in Figure 175.

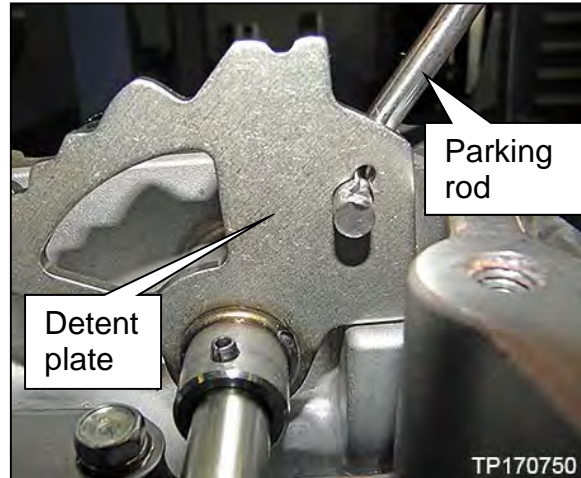

Figure 175

145. Rotate the detent plate until the detent is in the “D” position (Figure 176 and Figure 177).

- The detent roller position shall be on the second left concave of the detent plate.

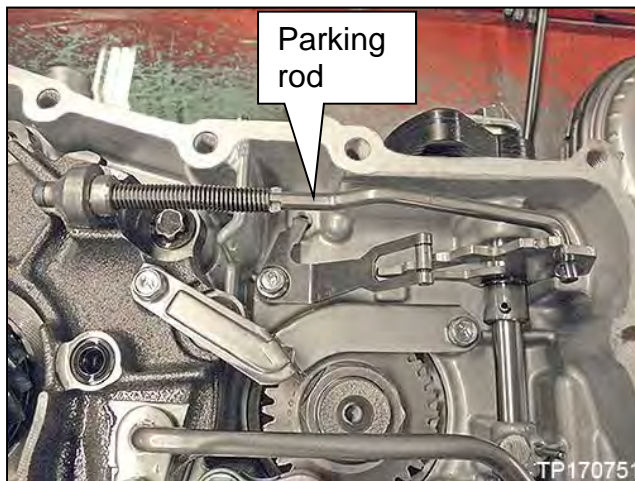

Figure 176

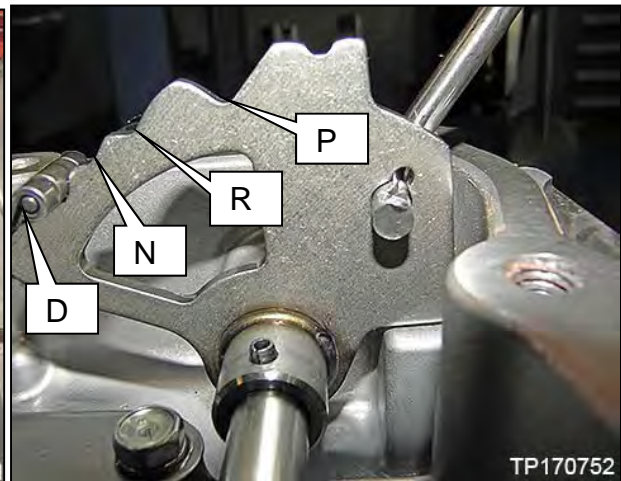

Figure 177

146. Install the oil pump chain onto the oil pump sprocket and the drive sprocket and then lower onto the oil pump shaft (driven sprocket) (Figure 178 and Figure 179).
147. Expand the snap ring with a suitable tool, and then push down on the driven sprocket until it bottoms out.
148. Release the snap ring and then pull up on the driven sprocket until the snap ring locks into its groove.

HINT: A click sound can be heard when the snap ring locks in place.

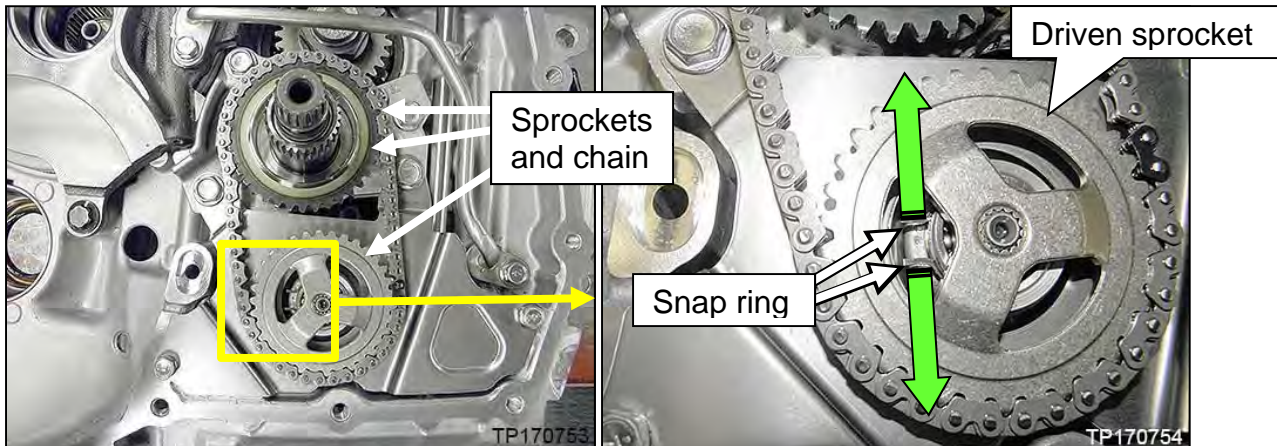

Figure 178

Figure 179

149. Install the original thrust bearing onto the drive sprocket.

HINT: Install the thrust bearing with the exposed bearings facing up.

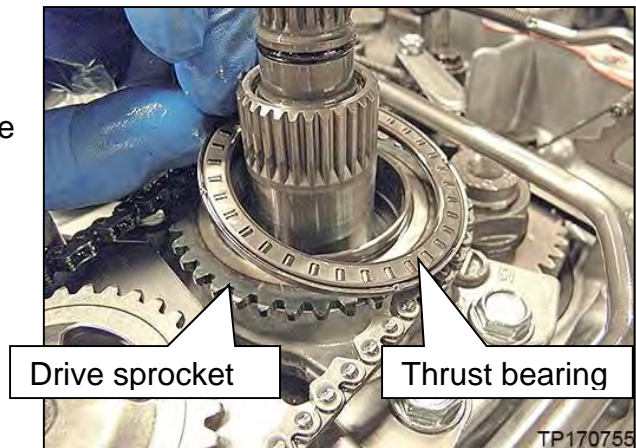

Figure 180

150. Rotate the input shaft by hand to confirm that the chain, pump and shaft rotate freely.

151. Install the new O-ring onto the input shaft.

- Use a new O-ring (non-reusable).
- Apply CVT Fluid to the O-ring before installation.

HINT: See Reference # 7 in the **KIT PARTS REFERENCE TABLE**.

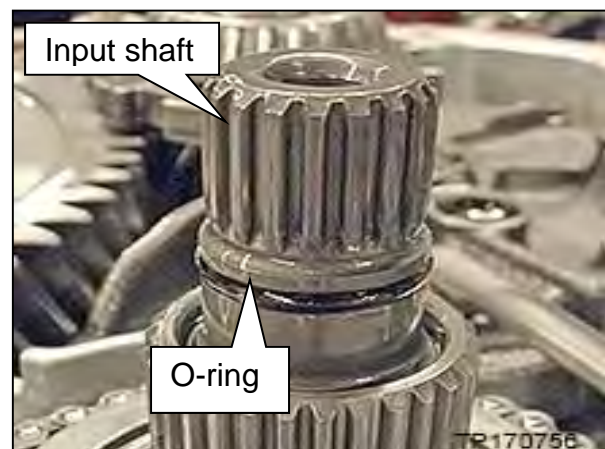

Figure 181

152. Install the CVT case O-ring (oval O-ring) to the CVT case.

- Use a new oval O-ring (non-reusable).
- Apply CVT Fluid to the O-ring before installation.

HINT: See Reference # 11 in the **KIT PARTS REFERENCE TABLE**.

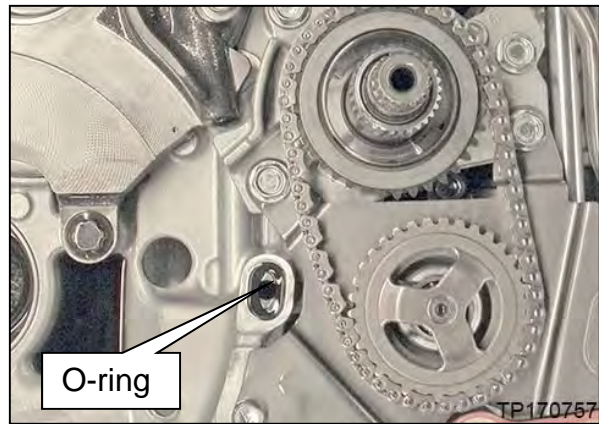

Figure 182

153. Install the lip seal to the CVT case.

- Use a new lip seal.
- Apply CVT Fluid to the lip seal before installation.

HINT: See Reference # 10 in the **KIT PARTS REFERENCE TABLE**.

154. Confirm that both seals are seated in their grooves.

- Use petroleum jelly to help hold the seals in place.

155. Replace the two machine cut seals (Ring Seals) of the reduction gear assembly, shown in Figure 184 and Figure 185 as follows:

- a. Clean any debris out of the machined grooves that the two Ring Seals will be installed into.

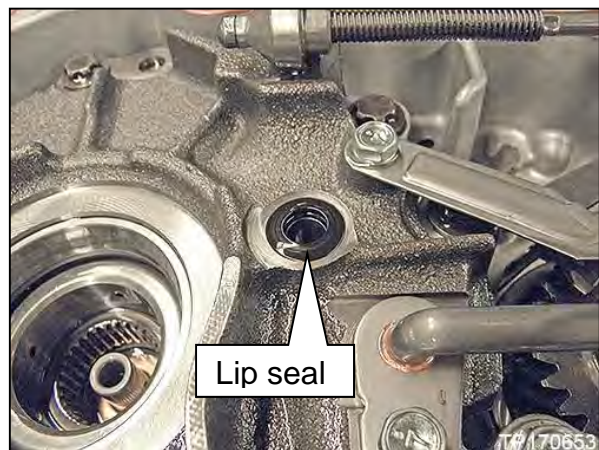

Figure 183

NOTICE These seals are VERY delicate. Handle with care to avoid damage.

HINT: See Reference # 21 in the **KIT PARTS REFERENCE TABLE**.

- Machine cut seals can be ordered in packs of 50. See the part number in **KIT PARTS REFERENCE TABLE**.

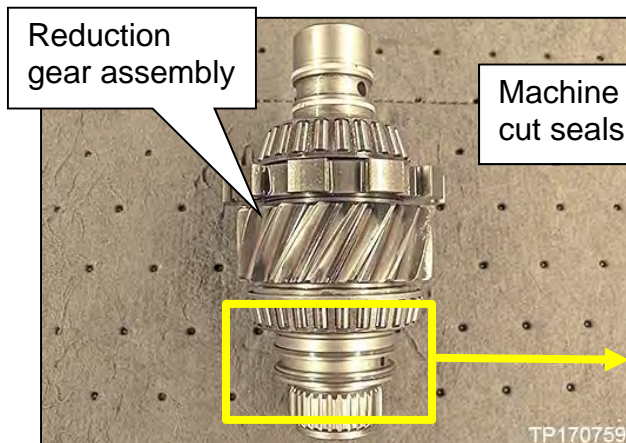

Figure 184

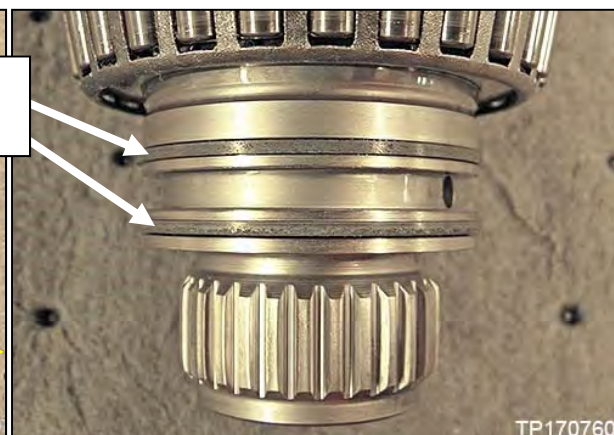

Figure 185

- b. Pre-lube both machined grooves with CVT fluid.
- c. Slide the First Groove Seal Tool (#J-52595-1) over the reduction gear shaft.
- d. Confirm that it is completely seated.
- e. Pre-lube both Ring Seals with CVT fluid.

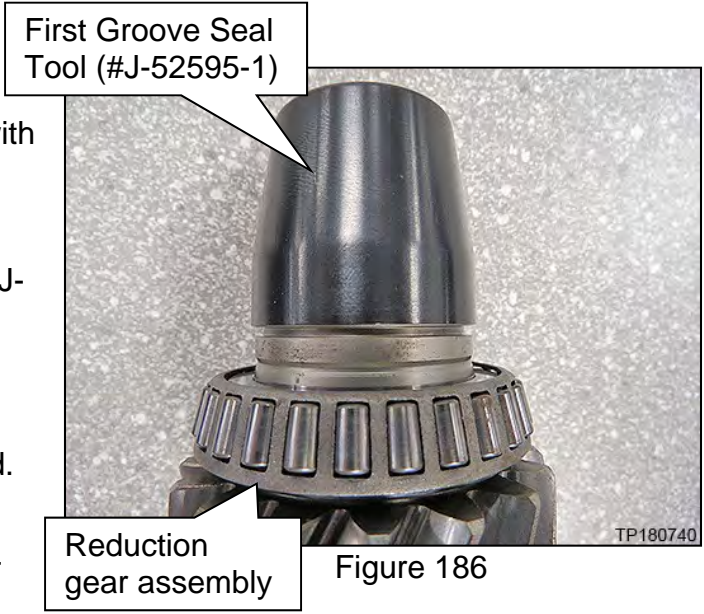

Figure 186

- f. Place one (1) Ring Seal onto the First Groove Seal Tool.
- g. Slide the Seal Driver (#J-52595-3) over the First Groove Seal Tool.
- h. Gently push the Ring Seal onto the first groove.
- i. Remove the First Groove Seal Tool.

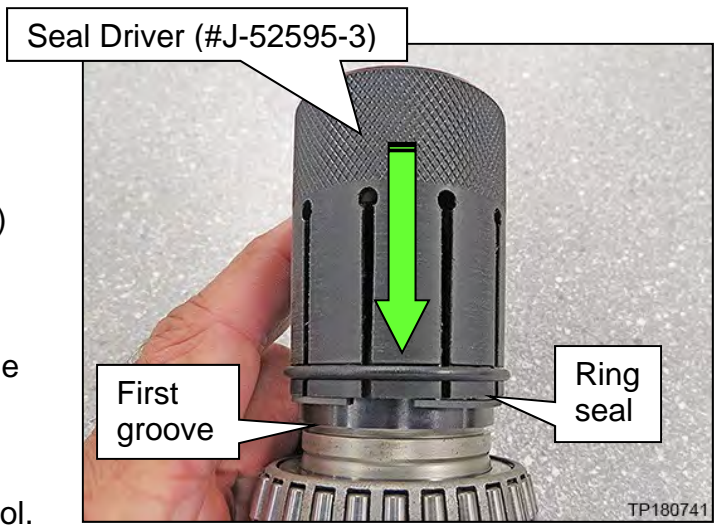

Figure 187

- j. Slide the Second Groove Seal Tool (#J-52595-2) over the reduction gear shaft.
 - Confirm that it is completely seated

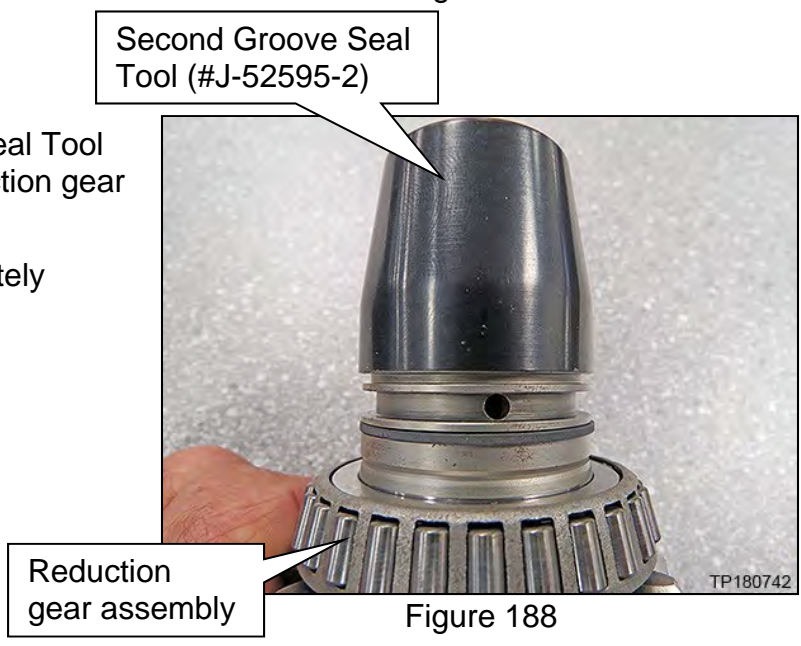

Figure 188

- k. Place one (1) Ring Seal onto the Second Groove Seal Tool.
- l. Slide the Seal Driver (#J-52595-3) over the Second Groove Seal Tool.
- m. Gently push the ring seal onto the second groove.
- n. Remove the Second Groove Seal Tool.

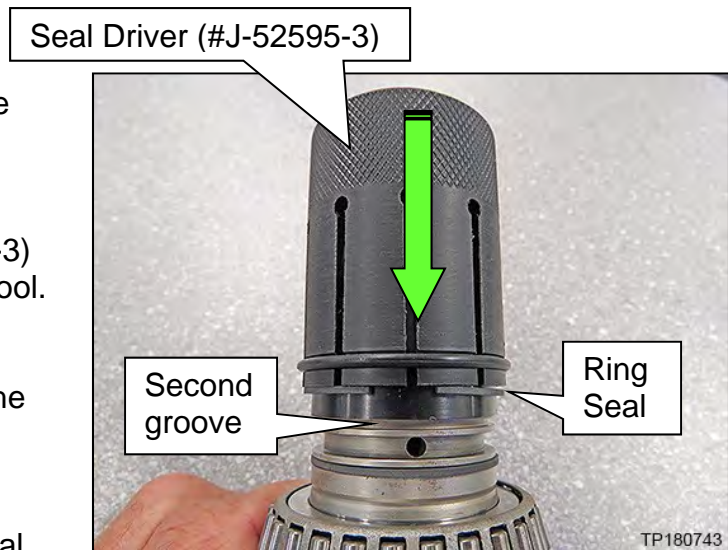

Figure 189

- Confirm that both of the Ring Seals are not protruding in any direction.

HINT: If the reduction gear shaft is not going to be immediately installed, the Split Ring Seal Cover (#J-52595-4) can be slid over both ring seals to prevent damage.

NOTICE In the following step use extreme care when installing the final drive and reduction gear assembly to avoid damage to components/seals.

- The machine cut seals are VERY delicate and will damage easily if forced.
- The reduction gear assembly should seat without any additional force.
- If the reduction gear assembly does not seat, remove it and confirm that machine cut seals are in place and centered in their grooves.

156. Confirm that the thrust bearing is in place in the bottom of the reduction gear assembly bore.

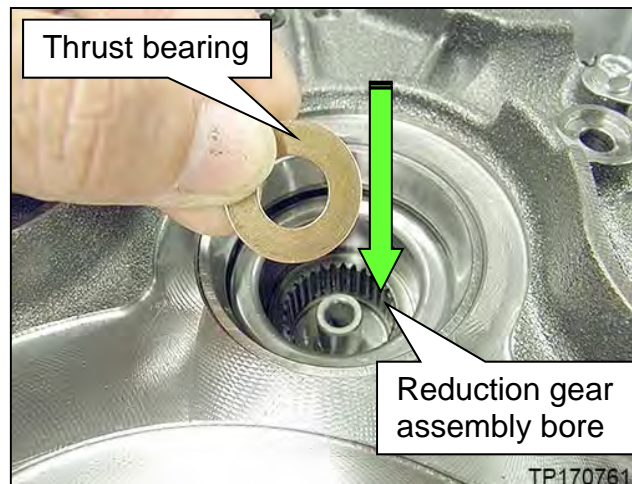

Figure 190

157. Install the final drive and reduction gear assembly together into the CVT case.

- If the reduction gear assembly does not seat, remove it and confirm that machine cut seals are in place and centered in their grooves.

158. Rotate the final drive by hand to confirm that it rotates freely.

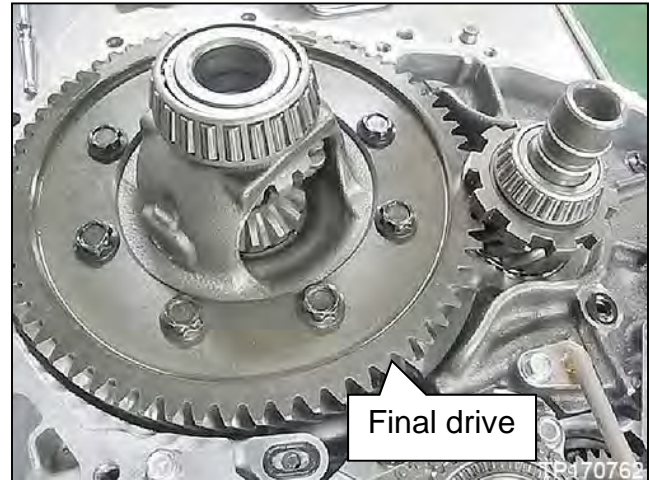

Figure 191

Install the Torque Converter Housing

159. Place the original thrust washer on the torque converter housing.

- Apply petroleum jelly to the mating surface side of the washer to hold the washer on the converter housing.

HINT: Both sides of the thrust washer are the same, orientation is not critical.



Figure 192

160. Remove any remaining CVT fluid on the sealing surfaces of the torque converter housing and the CVT case.

HINT: Brake cleaner is acceptable to remove remaining CVT fluid.

NOTICE To prevent possible CVT damage, prevent debris from entering into the torque converter housing or the CVT case.

161. Apply sealant to the CVT case side of the torque converter housing to CVT case mating surface.

- Sealant bead diameter: 2.0 mm

Sealant:

- Loctite 5460 (See the **PARTS INFORMATION** on page 140 of this bulletin)
- Color: Pink

IMPORTANT:

- Confirm that the mating surfaces are clean before applying sealant.
- Make sure that the starting point and the ending point of the sealant is between two bolt holes. Overlap both ends of the bead by 3 – 5 mm.
- If the Guide Pins were removed to clean the case surfaces, reinstall them now.

NOTICE Be careful not to contact or contaminate the sealant. If the sealant has been disturbed or contaminated in any way before case assembly, remove the sealant completely and re-apply to prevent possible leaks.

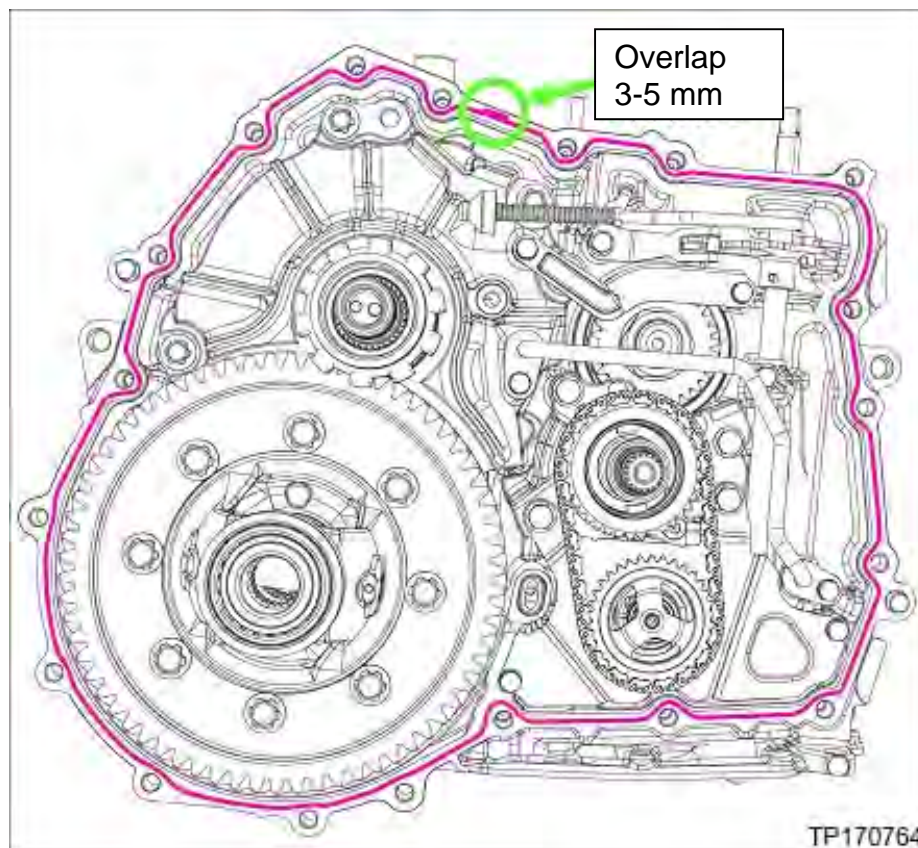

Figure 193

162. Install the torque converter housing onto the CVT case with nineteen (19) new bolts and torque to the following pattern shown in Figure 194.

NOTE: If the torque converter housing does not fully seat, the CVT may not be in Drive.

- Use new bolts.

HINT: See Reference # 9 in the **KIT PARTS REFERENCE TABLE**.

- Bolt torque: 27.1 N•m (2.8 kg-m, **20 ft-lbs.**)

IMPORTANT: Tighten the bolts in specific order shown below.

HINT: The bolts not visible in Figure 194 are indicated with a dotted green circle.

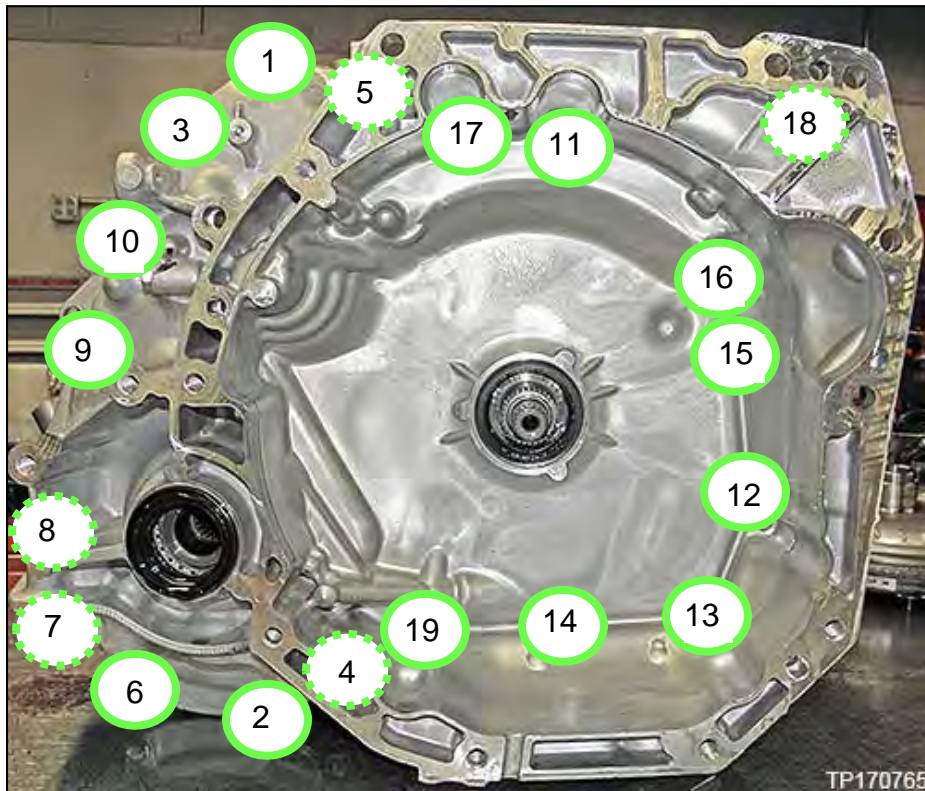

Figure 194

Install the Control Valve and Oil Pan

163. Rotate the CVT assembly so that the torque converter housing side is facing down.
164. Make sure that the terminal assembly is attached to the bracket of the new control valve (Figure 195).

HINT:

- Apply CVT Fluid to the O-ring of the terminal connector.
- See Reference # 1 in the **KIT PARTS REFERENCE**.

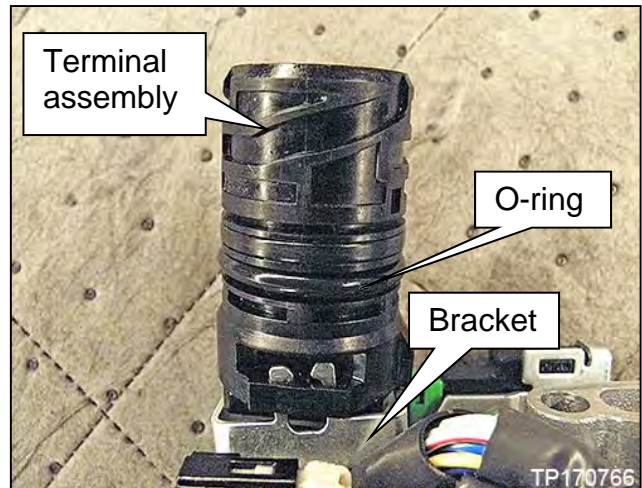

Figure 195

165. Install the new control valve assembly into the CVT case.
 - Insert the terminal assembly through the hole of the CVT case, and then push the new control valve horizontally with even pressure to seat the control valve completely.

HINT: A clicking sound may be heard as the new control valve is seated to the CVT case.



Figure 196

166. First tighten all eleven (11) original control valve bolts circled in yellow finger tight by hand, and then tighten to the specified bolt torque below.

NOTICE These bolts are easily stripped. Use care to not over-torque as this can damage the CVT.

- 87 mm (3.4 inches) long bolt.
11 pieces
 - Bolt torque:
7.9 N•m, (0.80 kg-m, 70 in-lbs.)

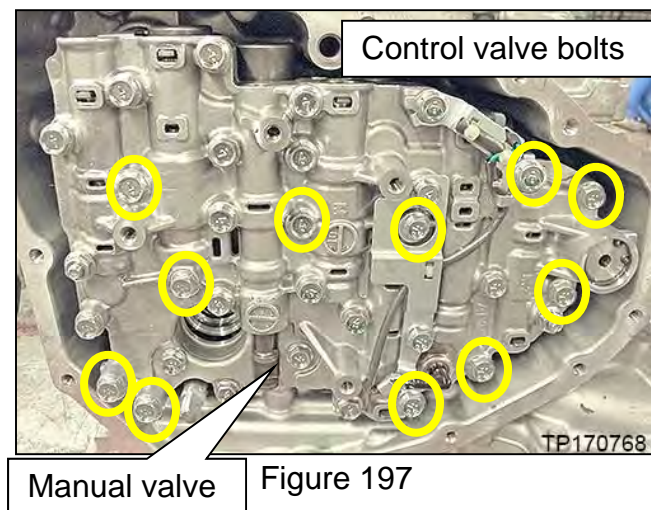

Figure 197

HINT: The manual valve may slide down and interfere with CVT case.

167. Install the original manual plate to the manual shaft with the original spring washer and lock nut.

- Use an adjustable wrench on the transmission range switch side of the manual rod to keep the shaft from rotating while tightening.
- Nut torque:
21.7 N•m (2.2 kg-m, **16 ft-lbs.**)

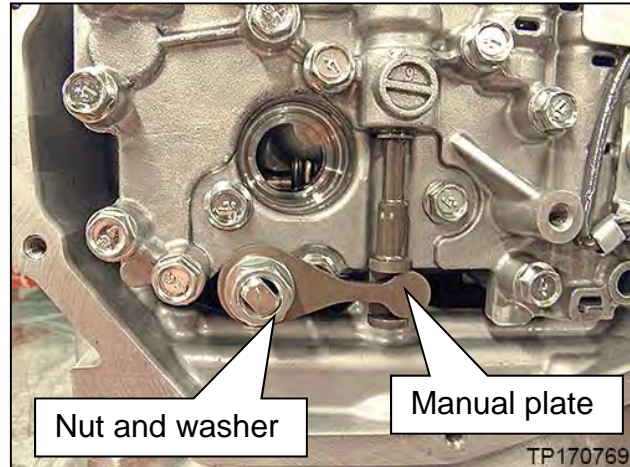

Figure 198

168. Confirm that the new O-ring is on the new oil strainer.

- Apply CVT Fluid to the O-ring before installation.

HINT:

- The new oil strainer comes with a new O-ring.
- See Reference # 3 in the **KIT PARTS REFERENCE TABLE.**



Figure 199

169. Install the new oil strainer to the control valve with the three (3) original bolts.

- 12 mm (**0.5 inches**) long bolt, 3 pieces
 - Bolt torque:
7.9 N•m (0.80 kg-m, **70 in-lbs.**)

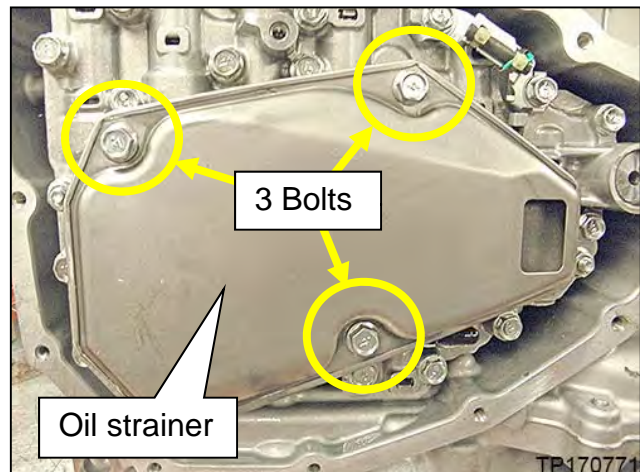

Figure 200

170. Remove the magnets from the CVT oil pan.

HINT: The CVT oil pan may come with two (2) or three (3) magnets.

171. Clean the magnets.

172. Clean the CVT oil pan.

173. Reinstall the magnets to the CVT oil pan in their original positions.

174. Install the CVT oil pan with a new oil pan gasket using the original bolts.

- Bolt torque:
5.6 N•m (0.60 kg-m, **50 in-lbs.**)

HINT: See Reference # 2 in the **KIT PARTS REFERENCE TABLE.**



Figure 201

Seal the Sub-assembly Cover

175. Confirm the torque converter housing side is facing down.

176. Remove the two temporary side cover bolts.

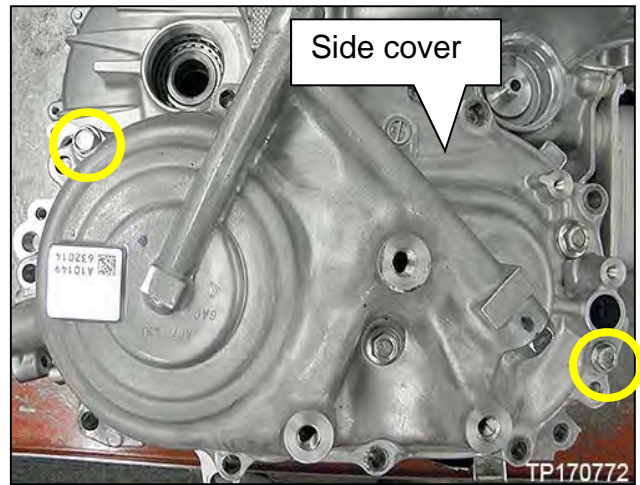

Figure 202

177. Remove the two pulley bearing retainer bolts.

- These bolts will be reused later in this procedure.

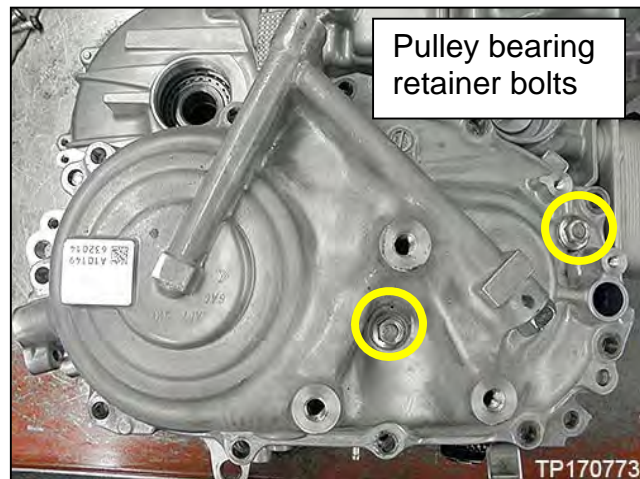

Figure 203

178. Remove the side cover.

- Use a slide hammer (J-25721-A) if needed.
- There are three slide hammer tool locations on the side cover.

HINT: Figure 204 shown with side cover removed.

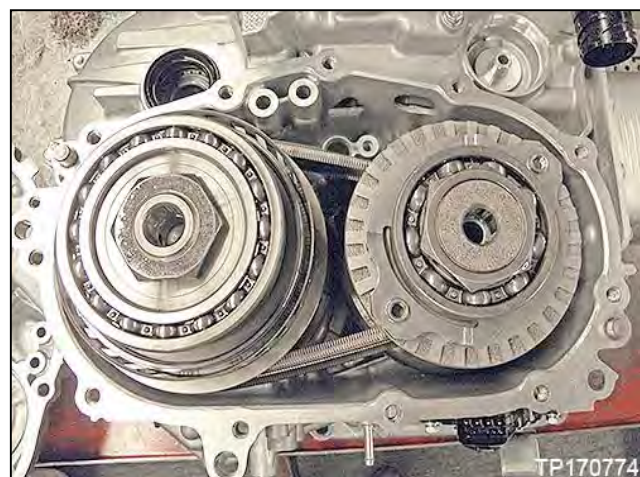

Figure 204

179. Install the original lubrication tube into the CVT case.

- Place the fluid jet nozzle under the CVT belt and then insert the lubrication tube into the CVT case.

NOTICE To avoid damage to the CVT belt, take care not to contact the CVT belt with any tools during tube installation.

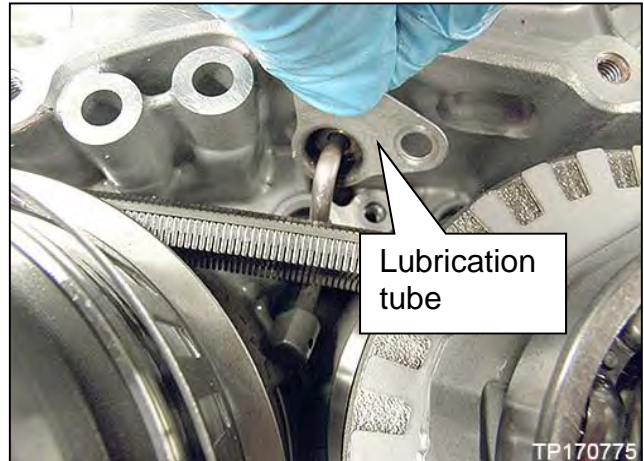

Figure 205

180. Install the original lubrication tube bolt.

- 16 mm (**0.6 inches**) long bolt.
 - Bolt torque:
6.8 N•m (0.70 kg-m, **60 in-lb**).

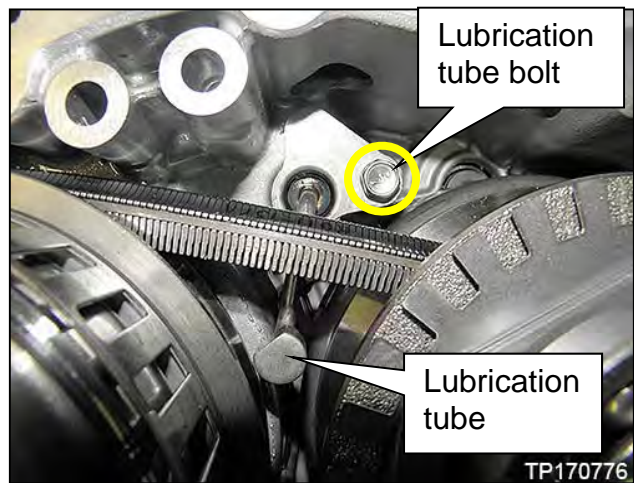

Figure 206

181. Apply sealant to the side cover sealing surface of the CVT case.

- Sealant bead diameter: 2.0 mm

Sealant:

- Loctite 5460 (See the **PARTS INFORMATION** on page 140 of this bulletin)
- Color: Pink

IMPORTANT:

- Confirm that the mating surfaces are clean before applying sealant.
- Make sure that the starting point and the ending point of the sealant is between two bolt holes. Overlap both ends of the bead by 3 – 5 mm.

NOTICE Be careful not to contact or contaminate the sealant. If the sealant has been disturbed or contaminated in any way before side cover assembly is installed, remove the sealant completely and reapply to prevent possible leaks.

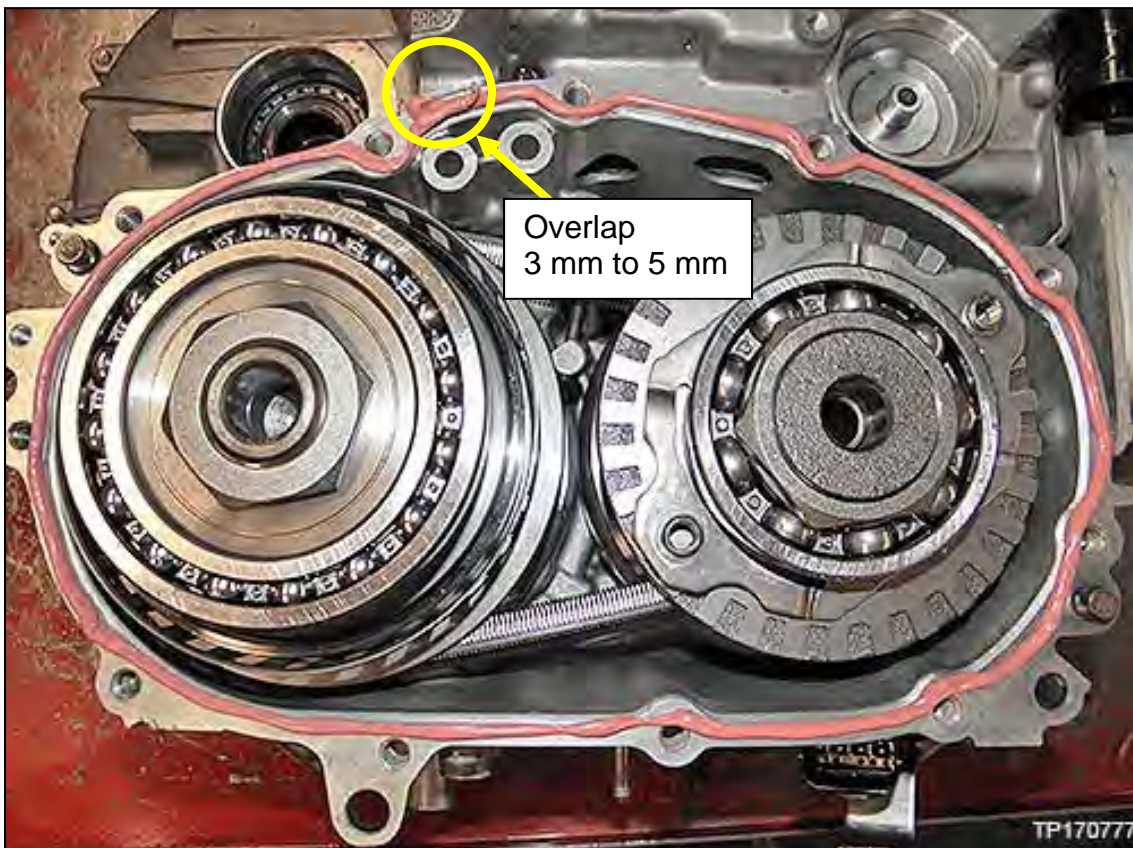

Figure 207

182. Screw in Guide Pin (J-52272) to either one of the two female bolt threads of the pulley bearing retainer.

- Place the guide pin next to the case bolt hole as shown in Figure 208.

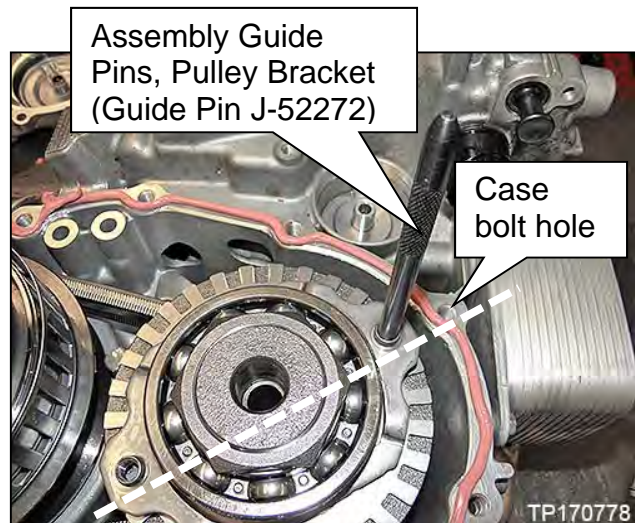

Figure 208

183. Install the side cover.

184. Install eleven (11) new side cover bolts, and then torque all of the side cover bolts to the specified torque in the sequence shown in Figure 209.

- 32.8 mm (1.3 inches) long bolt, 11 pieces
 - Bolt torque:
27.1 N•m (2.8 kg-m, 20 ft-lbs.)

HINT: See Reference # 6 in the **KIT PARTS REFERENCE TABLE**.

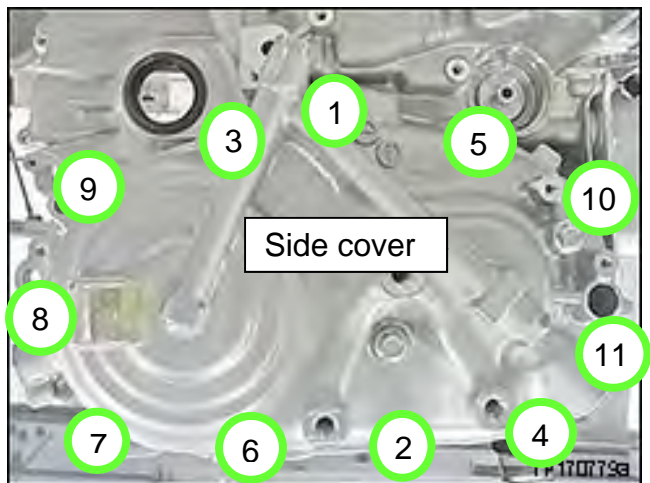

Figure 209

185. Remove the O-rings that came on the new bearing retainer bolts and replace them with new O-rings from **PARTS INFORMATION** on page 140.

HINT: See Reference # 8 in the **KIT PARTS REFERENCE TABLE**.

186. Screw in one (1) original pulley bearing retainer bolt, hand tight.

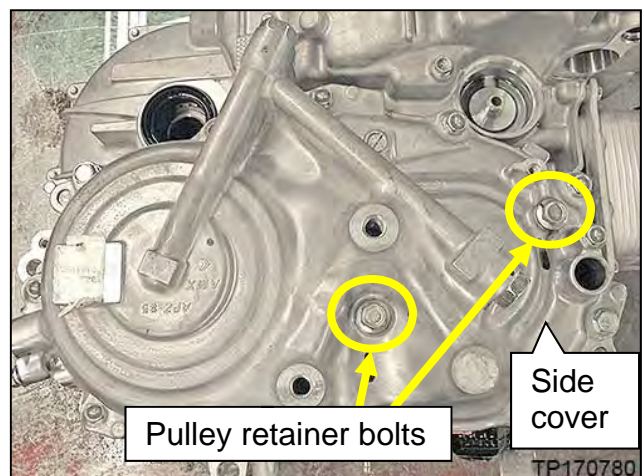

Figure 210

187. Remove the Guide Pin (J-52272) and then install the other pulley bearing retainer bolt, hand tight.

188. Torque the two pulley bearing retainer bolts to the specified torque.

- Bolt torque:
28.8 N•m, (2.90 kg-m, **21 ft-lbs.**)



Figure 211

Install and Adjust the Transmission Range Switch

189. Rotate the manual lever to the “N” position (two clicks counterclockwise from the left hard stop).

190. Remove the lock nut, washer and manual lever from the manual shaft.

- They will be reused.

191. Adjust the transmission range switch position as follows:

a. Install the alignment pin (#J-52306-2) into the Transmission Range Switch Alignment Bracket (#J-52306-1) as shown in Figure 213.

b. Attach the combined alignment tool onto the manual shaft as shown in Figure 214 with the part number facing out.

HINT: The combined alignment tool will only insert into the transmission range switch while in Neutral.

- Transmission range switch may need to be rotated to allow the pin to align.
- The alignment pin will insert into guide hole in the transmission range switch (Figure 212).

c. Install the two original bolts for the transmission range switch (Figure 214).

- Bolt torque:
5.6 N•m (0.60 kg-m, **50 in-lbs.**)
 - Remove the adjustment tool when complete.

192. Install the manual lever to the manual shaft.

a. Set the original manual lever onto the manual shaft.

b. Install the washer and the lock nut.

c. Torque the lock nut.

- Nut torque:
16.3 N•m (1.7 kg-m, **12 ft-lbs.**)

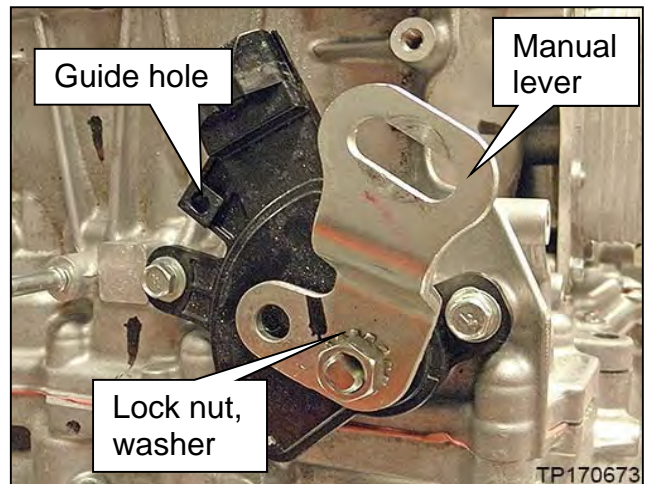

Figure 212

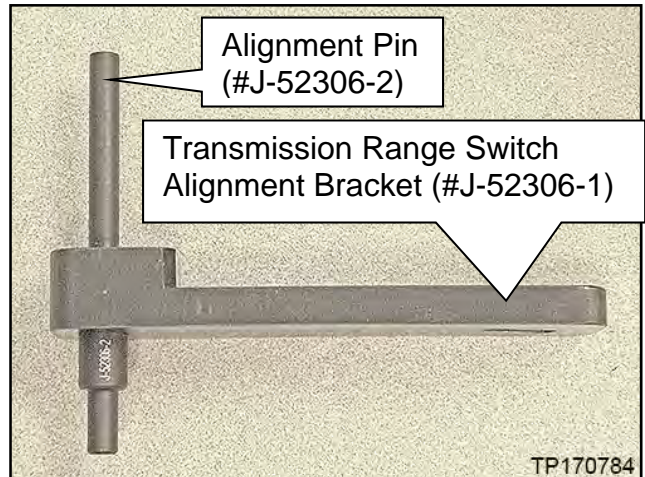

Figure 213

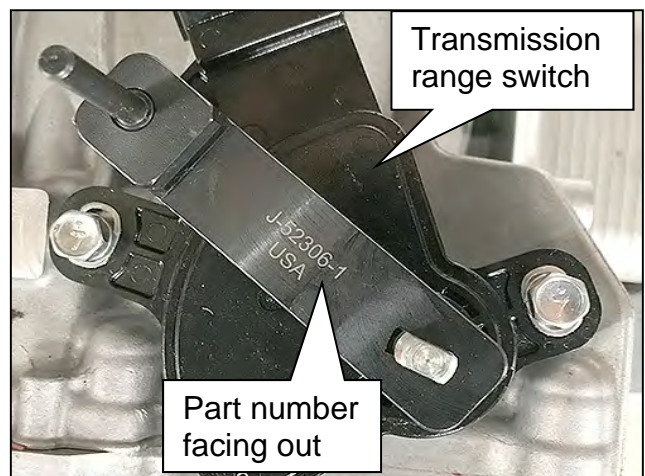
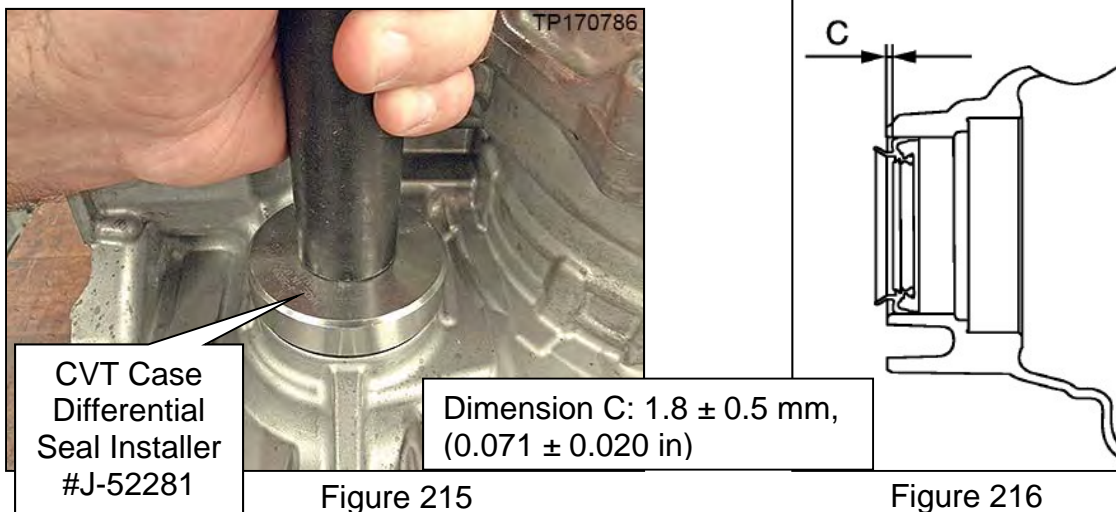

Figure 214

Install Exterior CVT Parts

193. Install the differential side oil seal to the CVT case (Figure 215).

- Use a new oil seal (non-reusable). See Reference # 18 in the **KIT PARTS REFERENCE TABLE**.
- Apply CVT Fluid to the oil seal before installation.
- Drive the differential side oil seal in until the amount of oil seal protrusion from the CVT case edge matches dimension C shown in Figure 216.



194. Install the differential side oil seal to the converter housing (Figure 217).

- Use a new oil seal (non-reusable). See Reference # 18 in the **KIT PARTS REFERENCE TABLE**.
- Apply CVT Fluid to the oil seal before installation.
- Drive the differential side oil seal in until the amount of oil seal protrusion from the torque converter housing edge matches Dimension D shown in Figure 218.

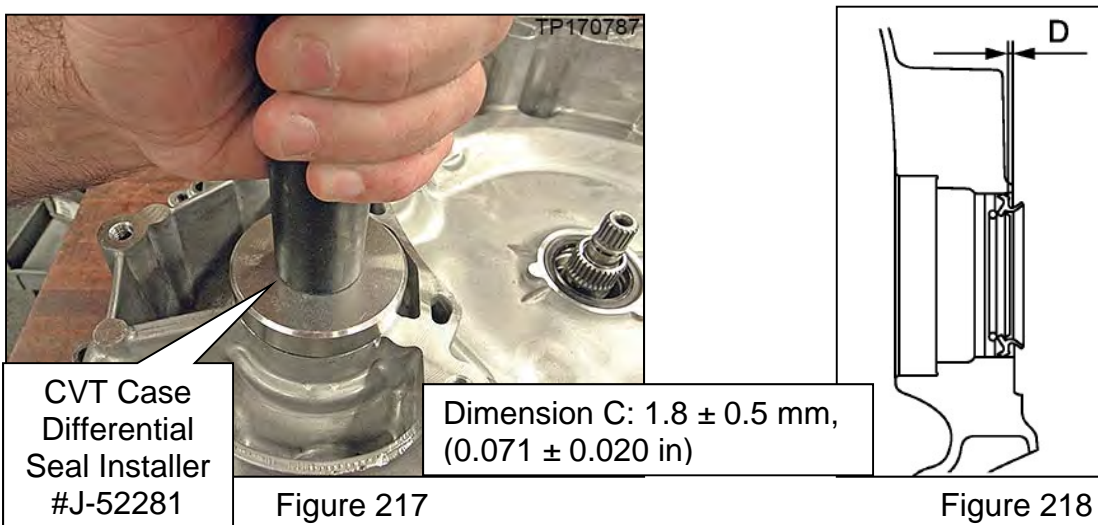

195. Install the torque converter housing oil seal to the torque converter housing (Figure 219).

- Use a new oil seal (non-reusable). See Reference # 17 in the **KIT PARTS REFERENCE TABLE**.
- Apply CVT Fluid to the oil seal before installation.
- Drive the converter housing oil seal evenly so that converter housing oil seal sits below the case by Dimension E as shown in Figure 220.

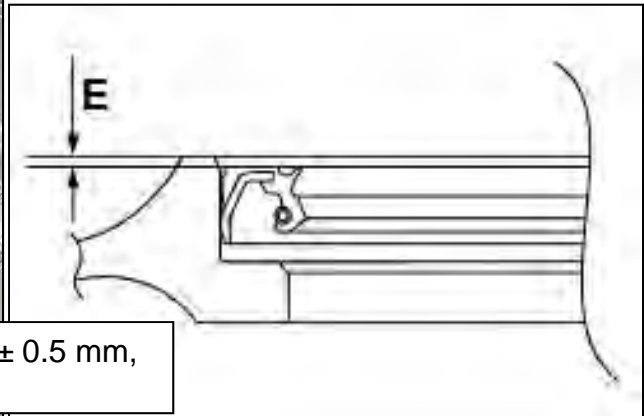
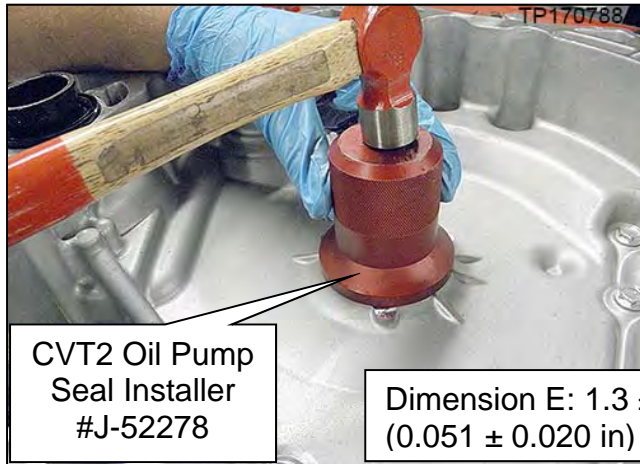

Figure 219

Figure 220

196. Install a new fluid filter to the CVT case.

- Make sure the grommet is attached to the fluid filter.
- Apply CVT Fluid to the grommet of the fluid filter.

HINT: See Reference # 16 in the **KIT PARTS REFERENCE TABLE**.

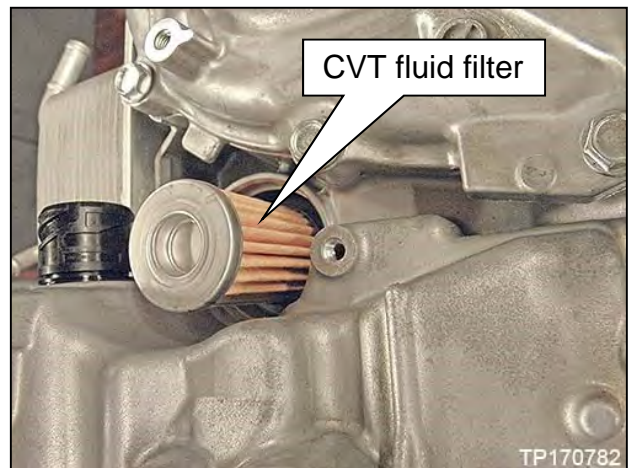

Figure 221

197. Install the new O-ring to the fluid filter cover.

- Apply CVT fluid to the O-ring.

HINT: See Reference # 15 in the **KIT PARTS REFERENCE TABLE**.



Figure 222

198. Install the fluid filter cover to the CVT case as follows:

- a. Locate the tab of the fluid filter cover near the tab of the side cover as shown in Figure 223.
- b. Push the fluid filter cover onto the CVT case.
- c. Rotate the fluid filter cover clockwise, and then align the bolt hole of the fluid filter cover with the bolt hole of the CVT case.

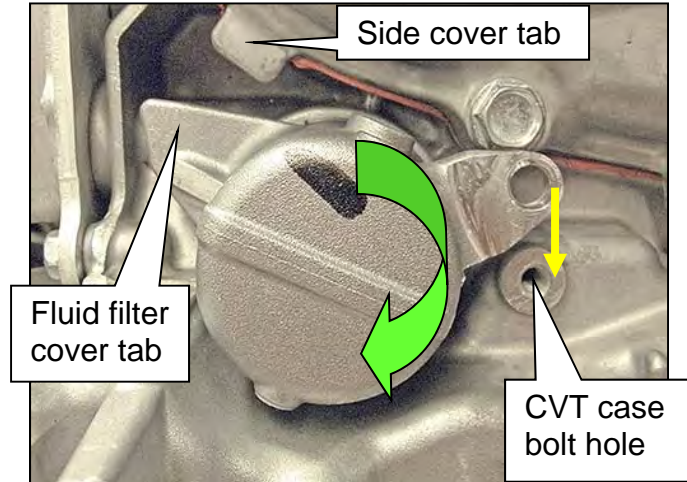

Figure 223

- Confirm that the fluid filter tab is underneath the side cover tab.

- d. Install the original bolt.
 - 16 mm (**0.6 inches**) long bolt.
 - Bolt torque:
6.8 N•m
(0.70 kg-m, **60 in-lbs.**)

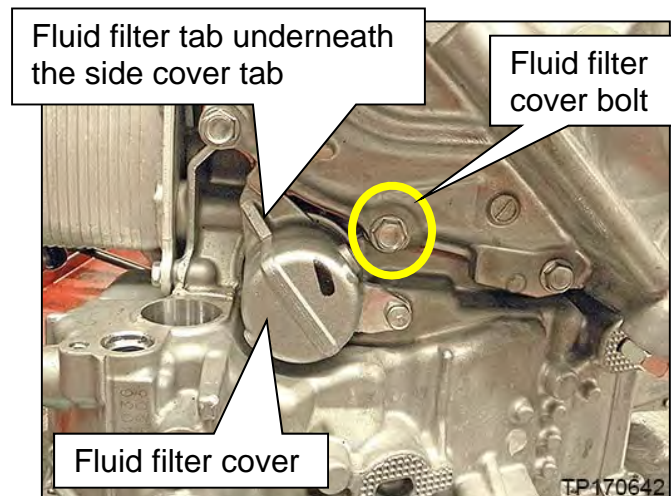

Figure 224

199. Install new O-rings to the original output speed sensor, primary pulley speed sensor and secondary pulley speed sensor and then install them to the CVT.

- The sensor O-rings are one-time use parts. Do not-reuse.

HINT: See Reference # 19 in the **KIT PARTS REFERENCE TABLE**.

- Apply CVT Fluid to the O-rings before installation.
- 16 mm (**0.6 inches**) long bolts.
- Bolt torque: 5.6 N•m (0.60 kg-m, **52 in-lbs.**)

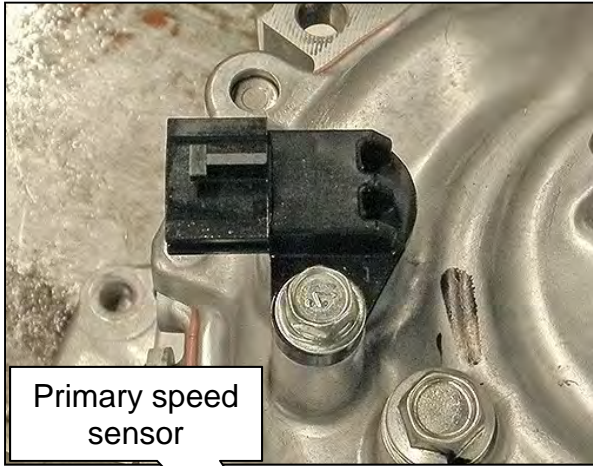

Primary speed sensor

Figure 225

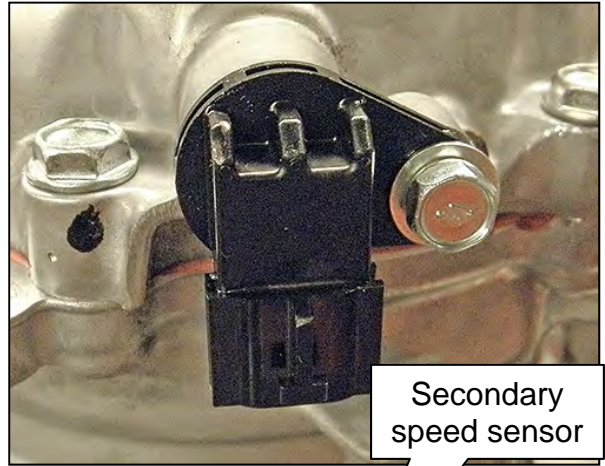

Secondary speed sensor

Figure 226

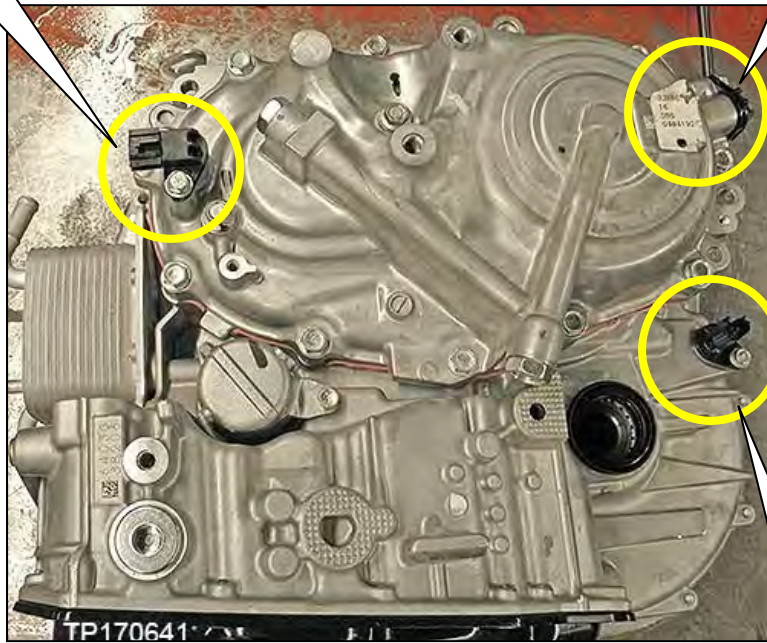
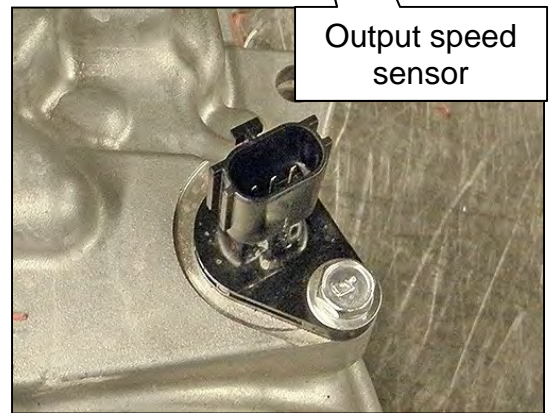

Figure 227



Output speed sensor

Figure 228

200. Place the CVT on a work surface with the oil pan side facing down.

201. Install the original torque converter.

NOTICE Locate the two oil pump engagement tabs on the end of the torque converter snout horizontally while inserting to avoid damaging the torque converter oil seal.

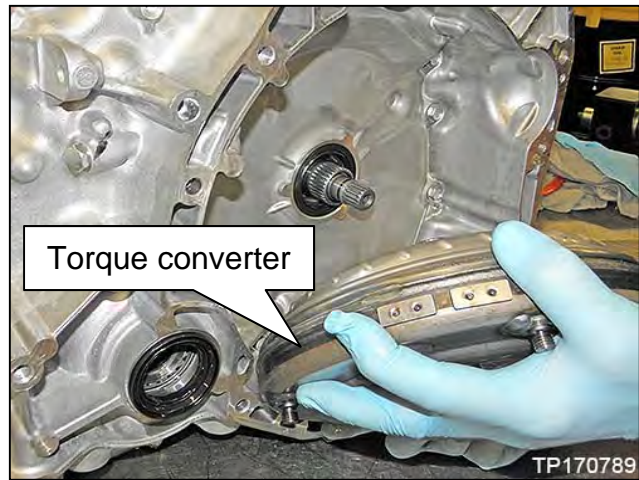

Figure 229

202. Measure dimension A to confirm that the torque converter is installed to the correct position (Figure 230).

- Dimension A: 14.4 mm (0.567 in)

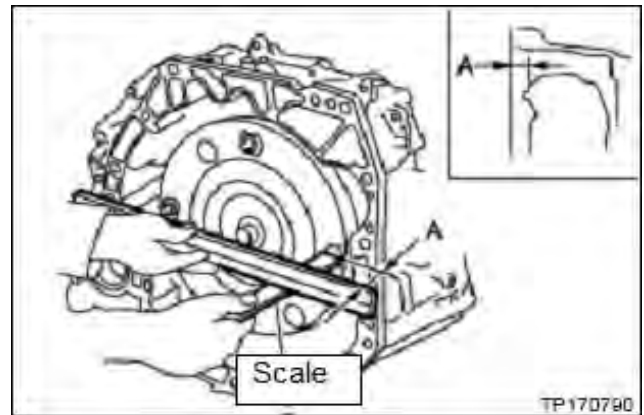

Figure 230

Install the CVT Assembly

203. Install the CVT assembly into the vehicle.

- Refer to the ESM for CVT installation, **TRANSMISSION & DRIVELINE > TRANSAXLE & TRANSMISSION > CVT: RE0F11A > UNIT REMOVAL AND INSTALLATION.**

204. Flush the CVT cooler.

NOTICE To avoid possible contamination and damage to the CVT, the CVT cooler flush procedure must be performed.

- Refer to the ESM for CVT cooler flush, **TRANSMISSION & DRIVELINE > TRANSAXLE & TRANSMISSION > CVT: RE0F11A > BASIC INSPECTION > CVT FLUID COOLER SYSTEM > CVT FLUID COOLER FLUSH > CVT FLUID COOLER CLEANING PROCEDURE.**

205. Connect both battery cables, negative cable last.

206. Refer to the ESM for filling and adjusting the CVT fluid level, **TRANSMISSION & DRIVELINE > TRANSAXLE & TRANSMISSION > CVT: RE0F11A > PERIODIC MAINTENANCE > CVT FLUID.**

207. Reset/reinitialize systems as needed.

- Refer to the ESM, section **GENERAL INFORMATION > GENERAL INFORMATION > BASIC INSPECTION > INSPECTION AND ADJUSTMENT > ADDITIONAL SERVICE WHEN REMOVING BATTERY NEGATIVE TERMINAL,** for a listing of systems that require reset/initialization after reconnecting the 12V battery.
- This list often includes items such as radio, power windows, clock, sunroof, etc.

Proceed to the next page.

ADDITIONAL SERVICE WHEN REPLACING CONTROL VALVE OR TRANSAXLE ASSEMBLY

The following procedures, starting on the next page, must be performed in this order:

- a. **TCM REPROGRAMING**.....Page 107
- b. **CONTROL VALVE REPLACEMENT**.....Page 127
- c. **ERASING THE LEARNING VALUE**.....Page 132
- d. **CONFORM CVTF DETERIORATION**.....Page 134
- e. **AUXILIARY GEARBOX CLUTCH POINT LEARNING**.....Page 137
- f. **ERASE DTCS**.....Page 139

Proceed to the next page.

TCM Reprogramming

IMPORTANT: Repairs performed for this bulletin require CONSULT-III plus (C-III plus) Diagnostic result reporting function-Setting be turned ON and Diagnosis (All Systems) be performed. If not done, it may result in a repair being non-warrantable.

IMPORTANT: Before starting, make sure:

- ASIST on the CONSULT PC has been synchronized (updated) to the current date.
- All C-III plus software updates (if any) have been installed.
- The CONSULT PC is connected to the Internet (Wi-Fi or cable).

HINT:

- Most instructions for reprogramming with C-III plus are displayed on the CONSULT PC screen.
- If you are not familiar with the reprogramming procedure, click here. This will link you to the "CONSULT- III plus (C-III plus) Reprogramming" general procedure.

208. Connect the plus Vehicle Interface (plus VI) to the vehicle.

NOTICE Make sure the plus VI is securely connected. If the plus VI connection is loose during reprogramming, the process will be interrupted and the TCM may be damaged.

209. Connect the AC Adapter to the CONSULT PC.

NOTICE Be sure to connect the AC Adapter. If the CONSULT PC battery voltage drops during reprogramming, the process will be interrupted and the TCM may be damaged.

210. Connect a battery maintainer or smart charger, set to reflash mode or a similar setting, to the vehicle battery.

NOTICE Be sure the battery maintainer or smart charger is connected securely to the battery. Make sure the battery voltage stays between 12.0V and 15.5V during reprogramming. If the battery voltage goes out of this range during reprogramming, the TCM may be damaged.

211. Turn OFF all external Bluetooth® devices (e.g., cell phones, printers, etc.) within range of the CONSULT PC and the VI.

NOTICE Make sure to turn OFF all external Bluetooth® devices. If Bluetooth® signal waves are within range of the CONSULT PC and the VI during reprogramming, reprogramming may be interrupted and the TCM may be damaged.

212. Turn the ignition ON with the engine OFF.

- **The engine must not start or run during the reprogramming procedure.**

213. Turn OFF all vehicle electrical loads such as exterior lights, interior lights, HVAC, blower, rear defogger, audio, NAVI, seat heater, steering wheel heater, etc.

NOTICE Make sure to turn OFF all vehicle electrical loads. Make sure the battery voltage stays between 12.0V and 15.5V during reprogramming. If the battery voltage goes out of this range during reprogramming, the TCM may be damaged.

- 214. Connect the CONSULT PC to the vehicle to begin the reprogramming procedure.
- 215. Start C-III plus.
- 216. Wait for the plus VI to be recognized.
 - The serial number will display when the plus VI is recognized.
- 217. Select **Re/programming, Configuration**.

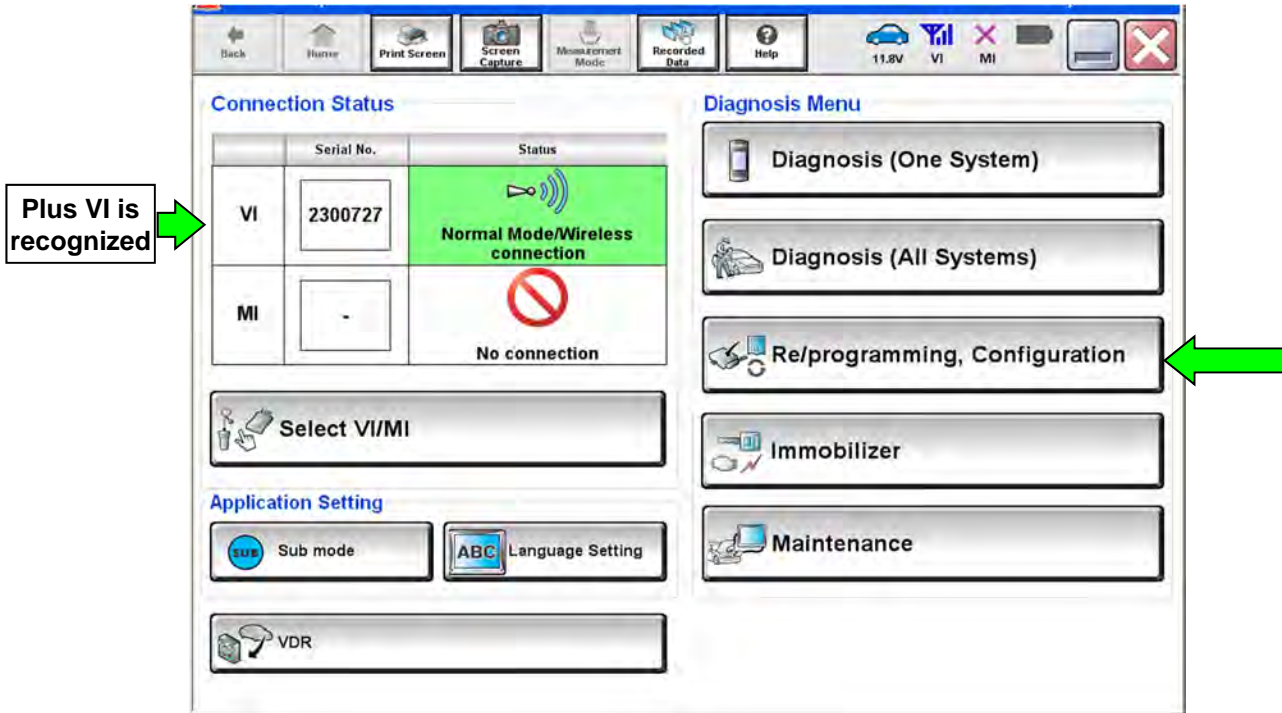

Figure 231

- 218. Use arrows (if needed) to view and read all precautions.
- 219. Check the box confirming the precautions have been read.
- 220. Select **Next**.

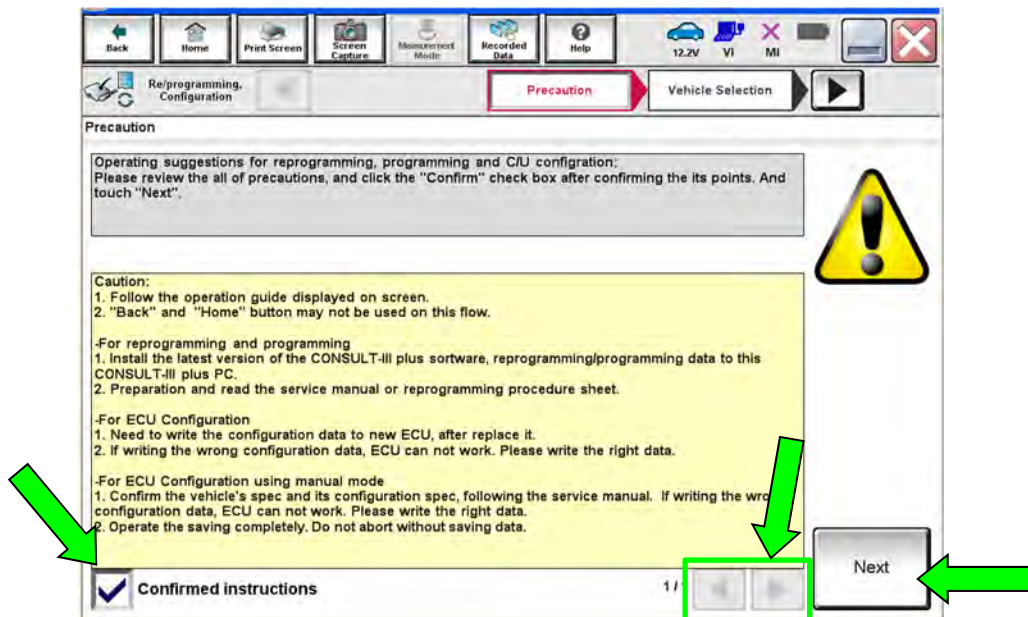

Figure 232

221. If the screen in Figure 233 displays, select **Automatic Selection(VIN)**.

- If the screen in Figure 233 does not display, continue to step 222.

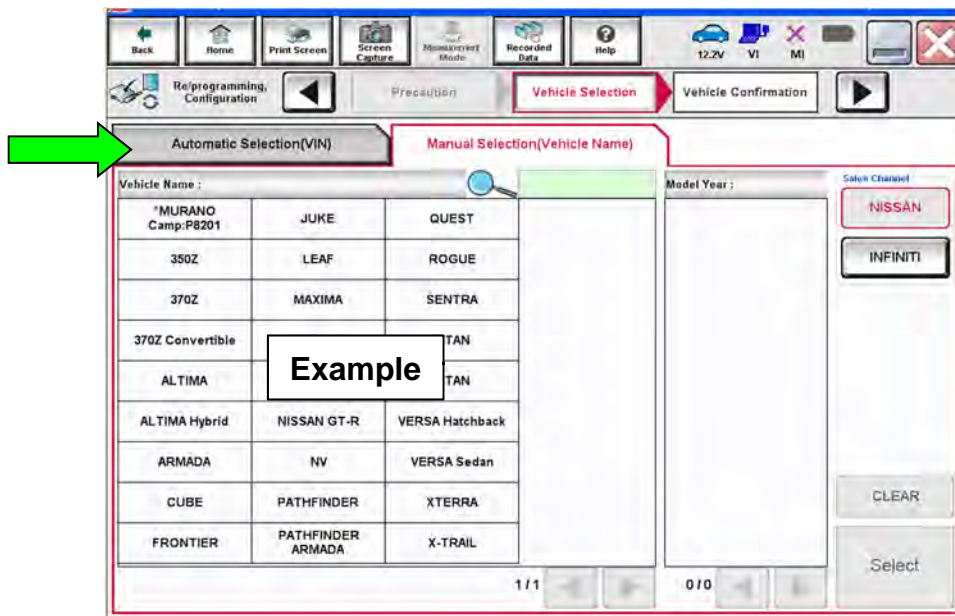

Figure 233

222. Make sure **VIN or Chassis #** matches the vehicle's VIN.

223. If the correct VIN is displayed, select **Confirm**.

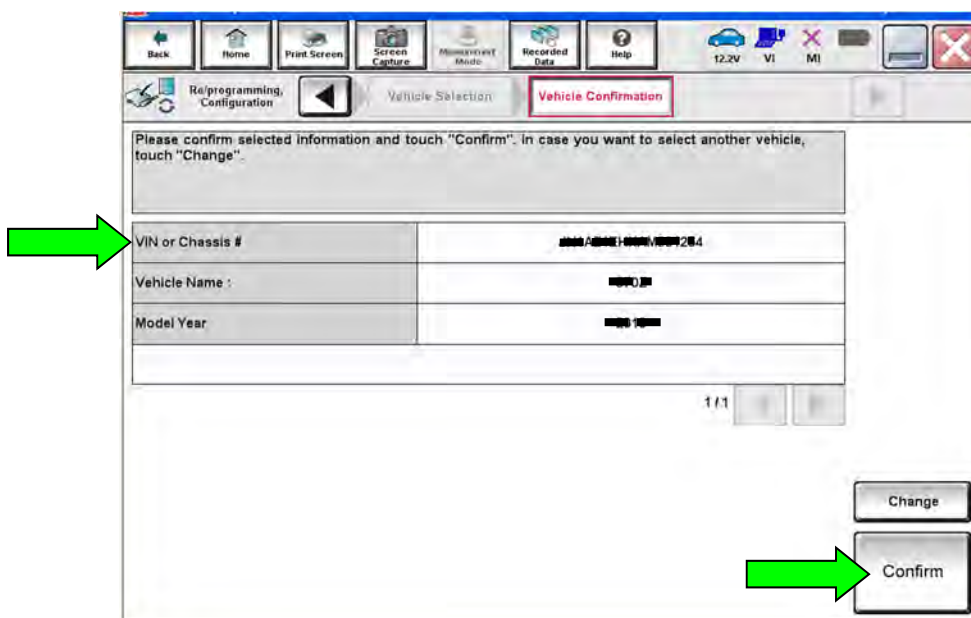

Figure 234

224. Select **Confirm**.

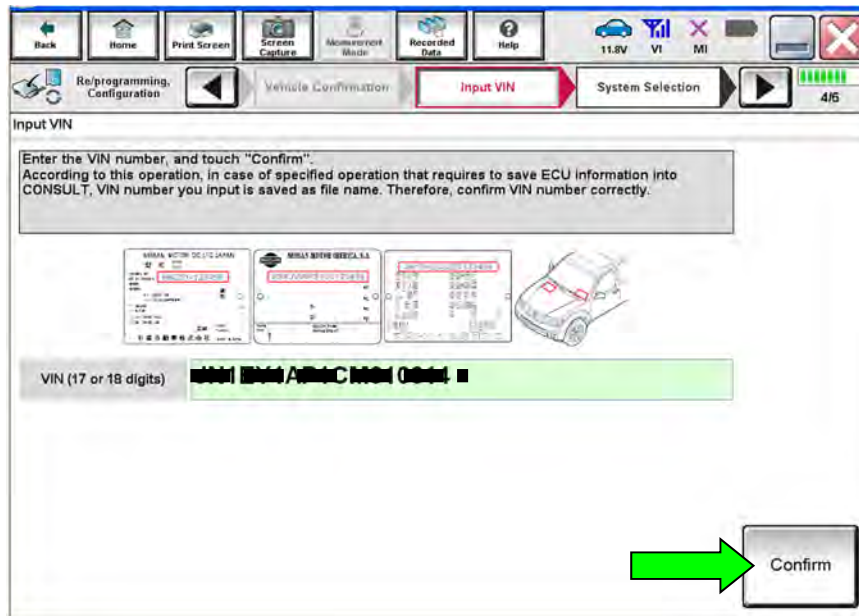

Figure 235

225. Select **TRANSMISSION**.

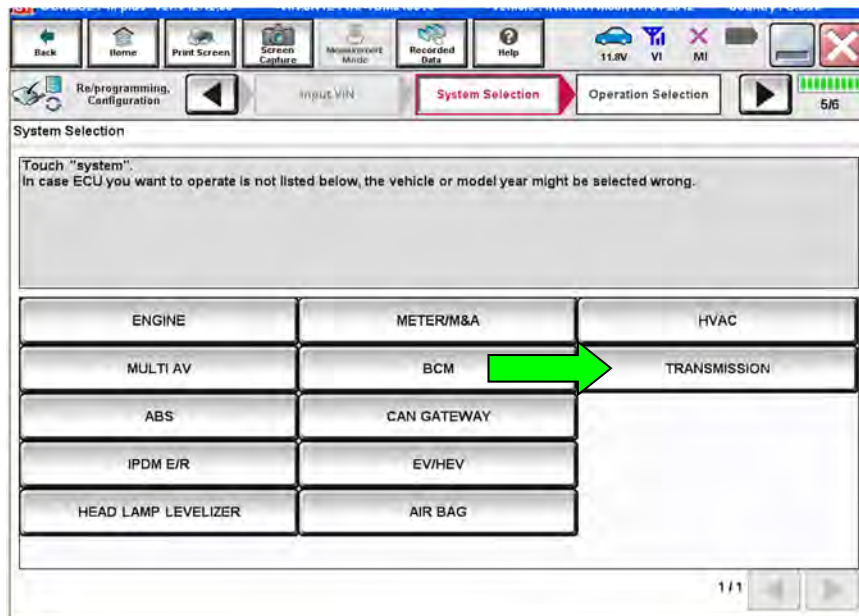

Figure 236

226. Select **Reprogramming**.

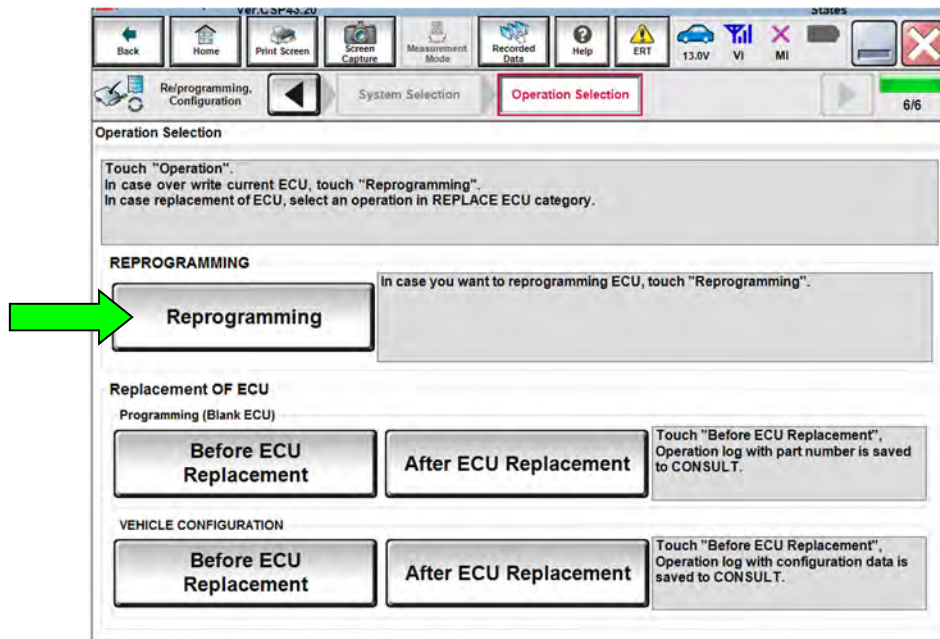

Figure 237

227. Follow the on-screen instructions; maintain the following conditions:

- a. Turn the ignition ON with the engine OFF.
- b. Press the brake pedal.
- c. Press the accelerator pedal between $\frac{1}{4}$ and $\frac{1}{2}$.
- d. Put the shift selector in **R**.

228. Select **Start**.

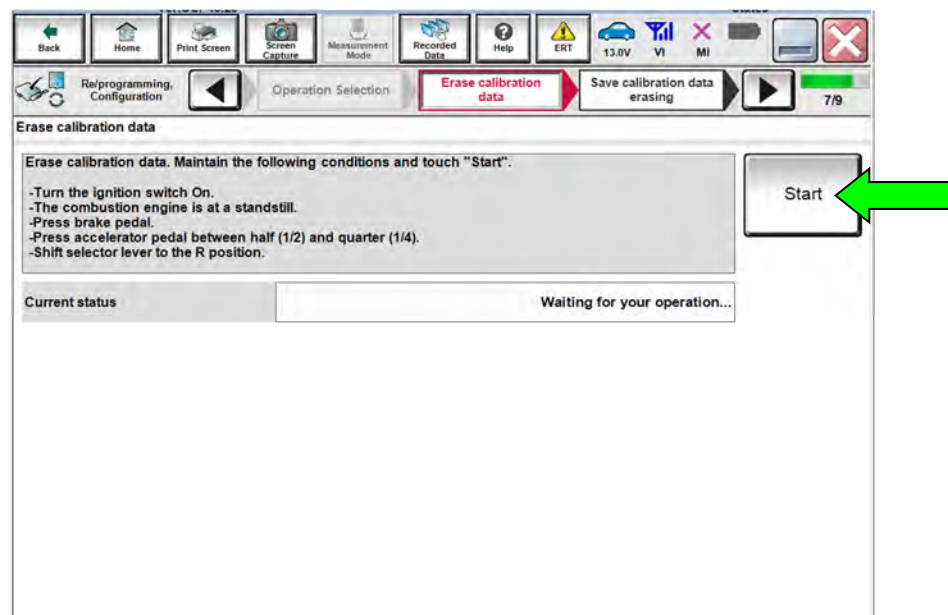

Figure 238

229. When **COMPLETED** is displayed, select **Next**.

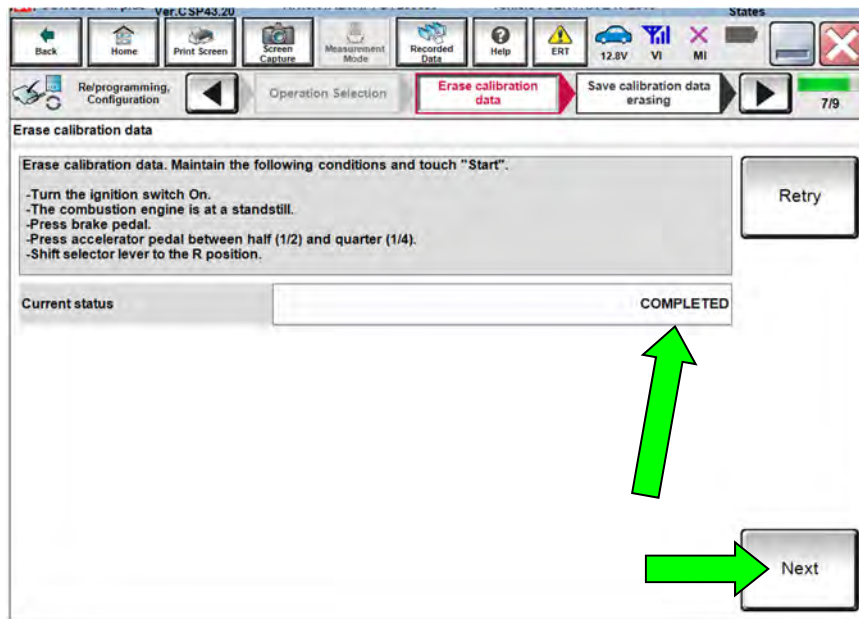

Figure 239

230. Operate the ignition per the on screen instructions.

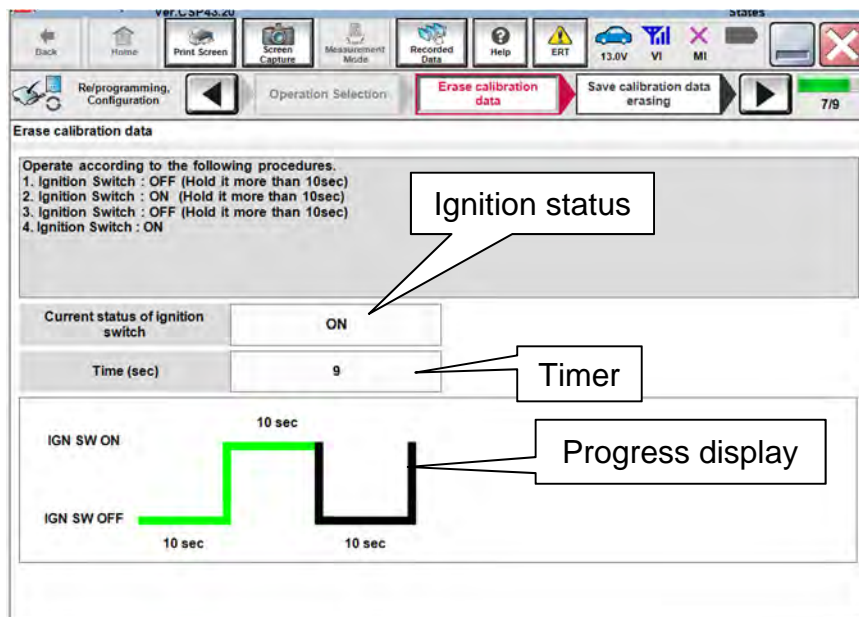

Figure 240

231. When **OK** is displayed, select **Next**.

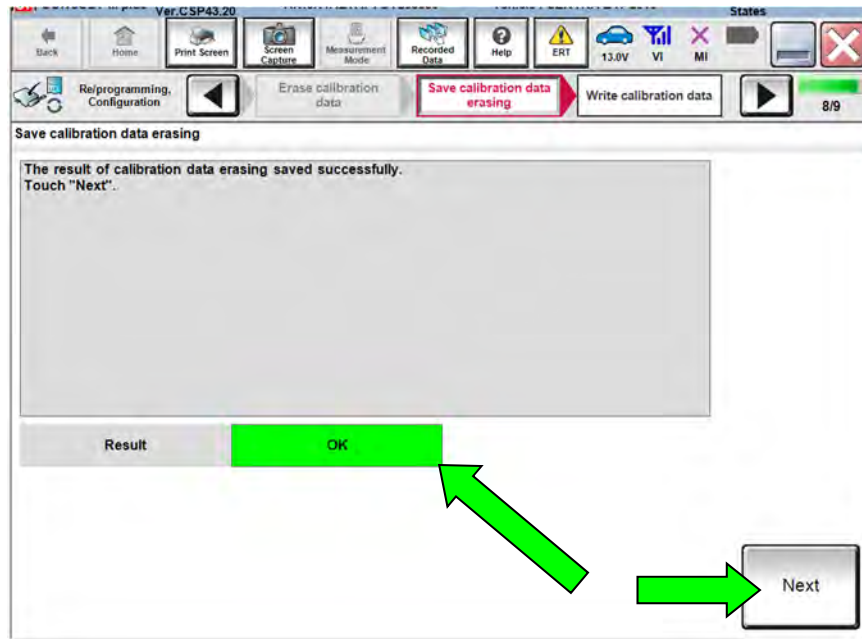

Figure 241

232. Move the shift selector to **P**, then select **Next**.

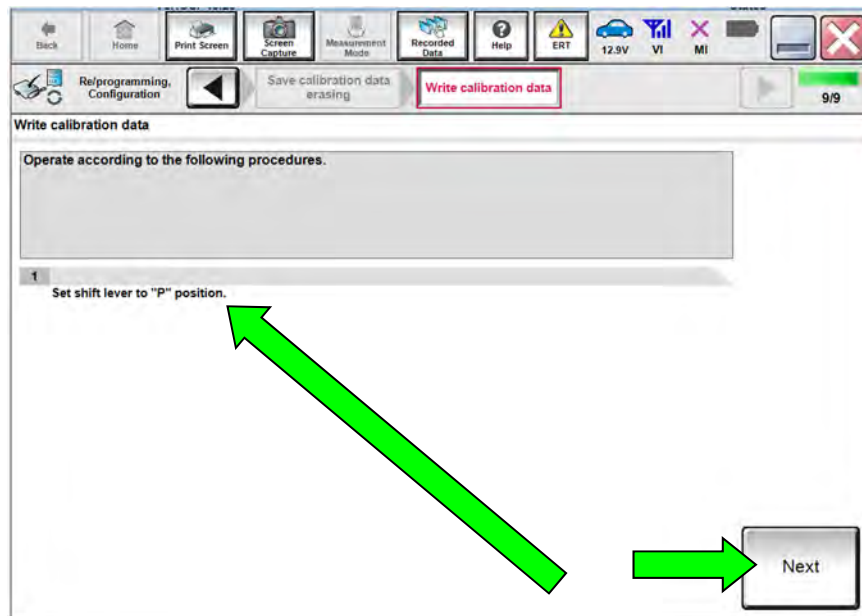

Figure 242

237. Comparison results:

- If there is a match, continue with the reprogramming procedure.
- If there is not a match, reprogramming is not needed. Skip to 266 on page 127.

Table B

MODEL	YEAR	CURRENT TCM PART NUMBER: 31036 -
Versa Sedan	2018	9KN4A, 9KN4B, 9KN4C, 9KN4D
	2019	9EK0A, 9EK0B, 9EK0C
Versa Note	2018	9ME3A, 9ME3B, 9ME3C, 9ME3D
	2019	9MG0A, 9MG0B, 9MG0C

238. Select **Save**.

239. Use arrows (if needed) to view and read all precautions.

240. Check the box confirming the precautions have been read and then select **Next**.

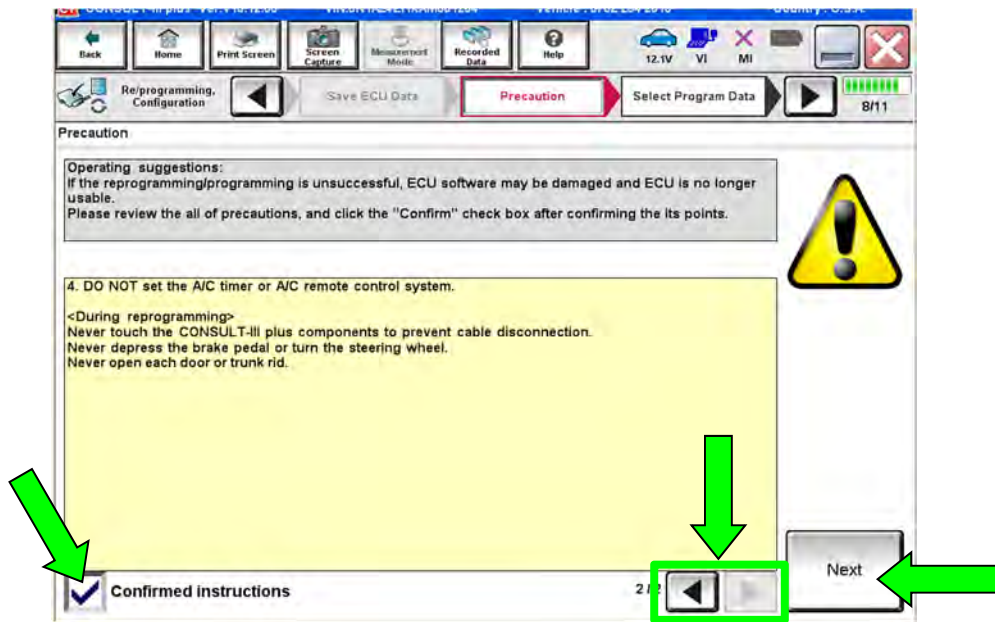

Figure 245

- 241. Read the **Current Part Number** and **Part Number After Reprogramming**. They should be different.
- 242. Select **Next**.

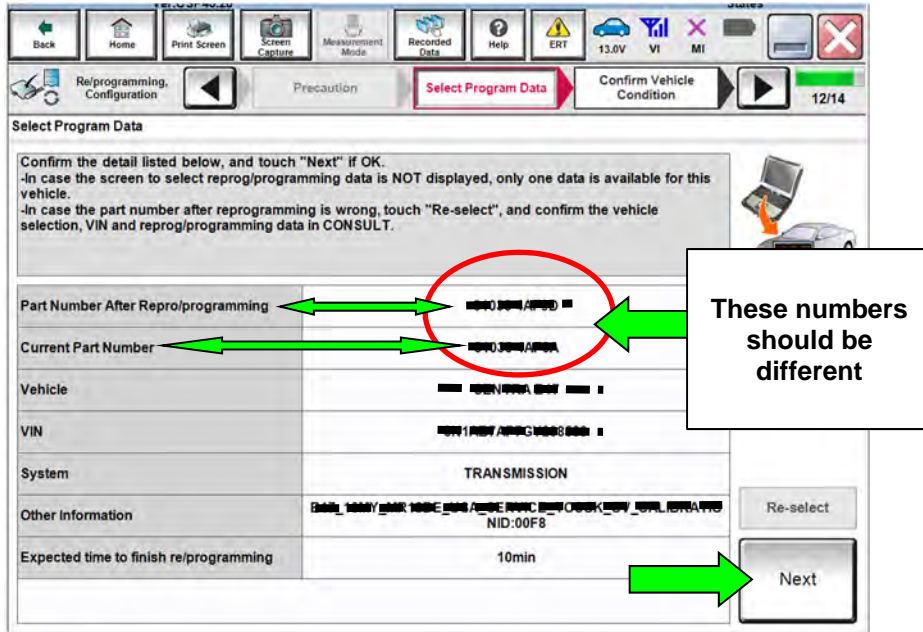

Figure 246

- 243. Make sure **OK** is highlighted **green** (battery voltage must be between **12.0 and 15.5 Volts**).
- 244. Select **Next**.

IMPORTANT: Battery voltage must stay between **12.0 and 15.5 Volts** during reprogramming or TCM reprogramming may be interrupted and TCM may be damaged.

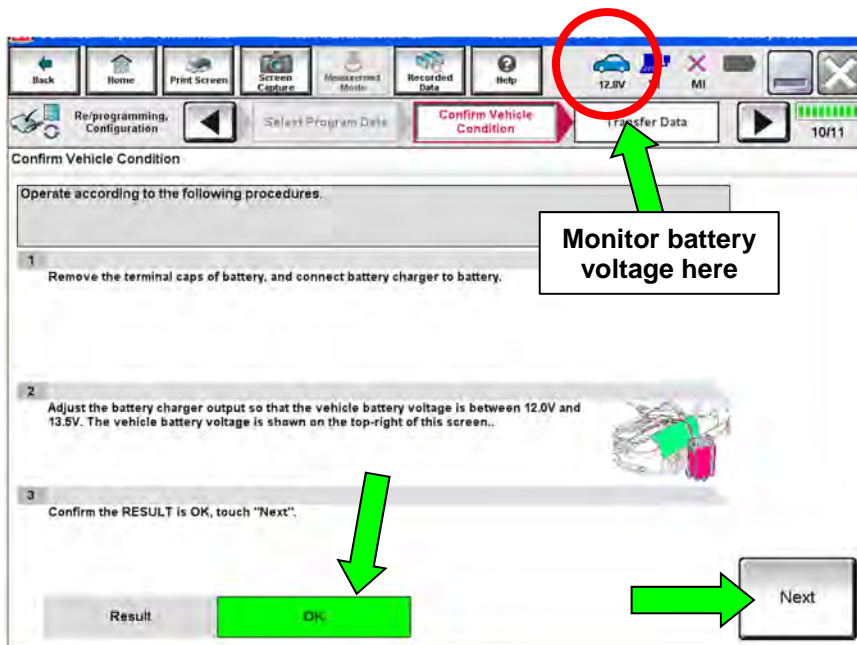

Figure 247

NOTE: In the next step, the reprogramming process will begin when **Start** is selected.

245. Select **Start**.

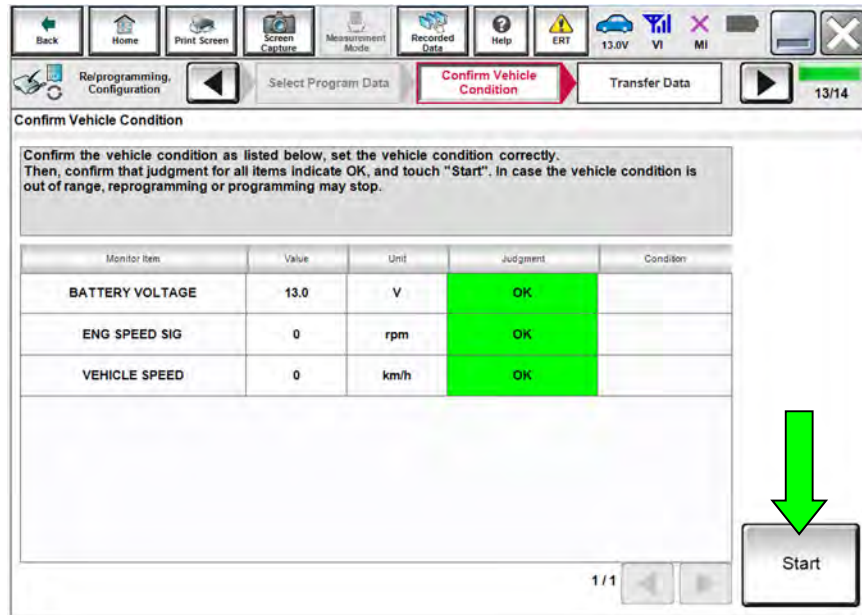

Figure 248

- If a screen displays asking for “Please select your user group”, select USA/CANADA Dealers.
- Before reprogramming will start, you will be required to enter your User Name and Password.
 - The CONSULT PC must be connected to the Internet (Wi-Fi or cable).
 - If you do not know your User Name and Password, contact your service manager.

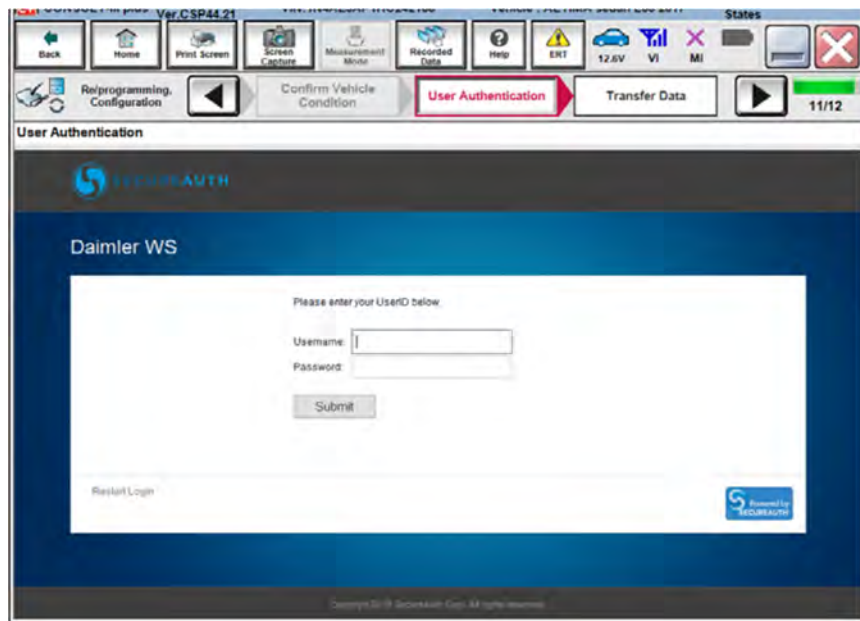

Figure 249

246. Wait for both progress bars to complete.

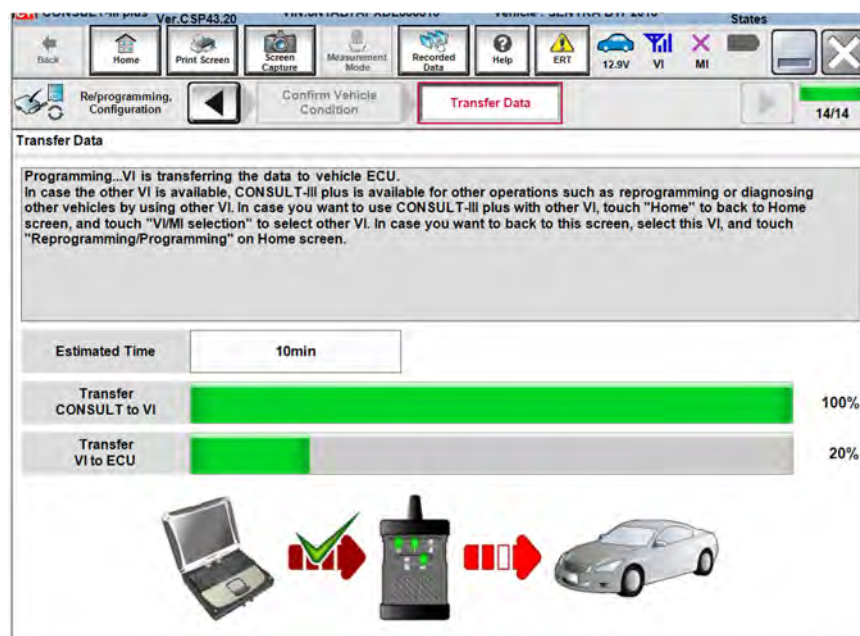

Figure 250

247. When the screen in Figure 251 displays, the reprogramming is complete.

NOTE: If the screen in Figure 251 does not display (which indicates reprogramming did not complete), skip to **TCM RECOVERY** on page 126.

248. Disconnect the battery maintainer/smart charger from the vehicle.

249. Select **Next**.

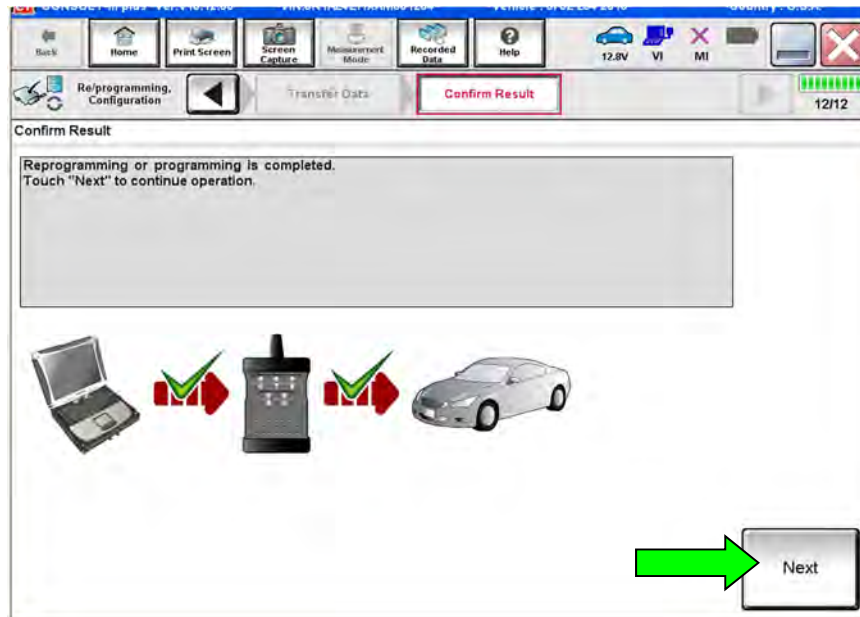

Figure 251

NOTE: Additional steps/operations are required before C-III plus will provide the final reprogramming confirmation report. Continue to step 250 on page 120 to complete the reprogramming procedure.

250. Confirm the Transmission Fluid temperature judgment is **OK**, then select **Next**.

- If the judgement is **NG**, drive the vehicle to warm the transmission until the judgement changes to **OK**.

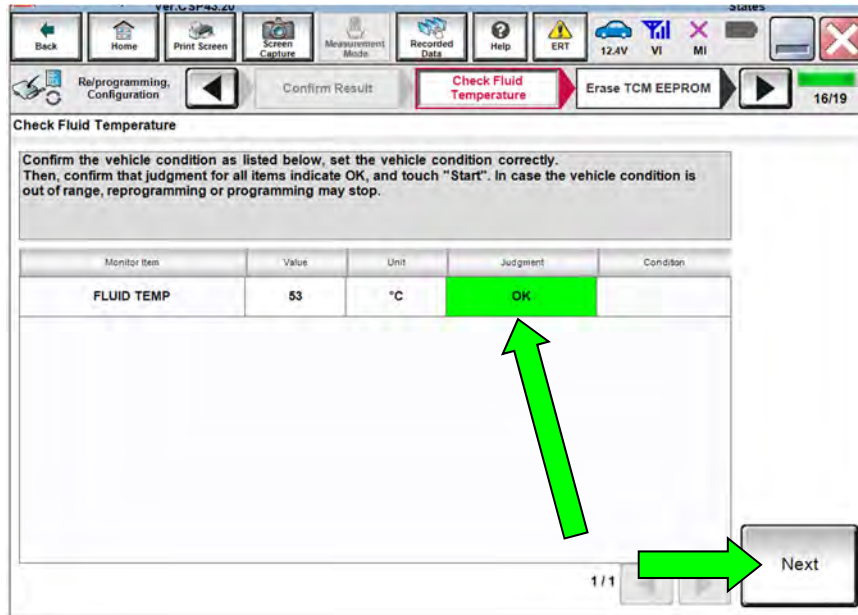

Figure 252

251. Follow the on-screen instructions while maintaining the following conditions:

- a. Parking brake set.
- b. Turn the ignition ON, with the engine OFF.
- c. Press the brake pedal.
- d. Press the accelerator pedal between $\frac{1}{4}$ and $\frac{1}{2}$.
- e. Put the shift selector in **R**.

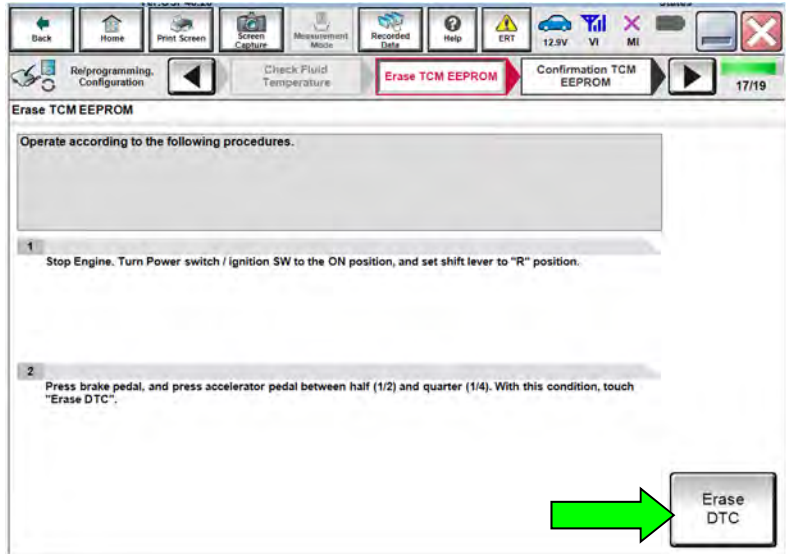

Figure 253

252. Select **Erase DTC**.

253. Follow the on-screen instructions while maintaining the following conditions:

- a. Parking brake set.
- b. Ignition ON, with the engine OFF.
- c. Fully depress the accelerator pedal.
- d. Put the shift selector in **R**.

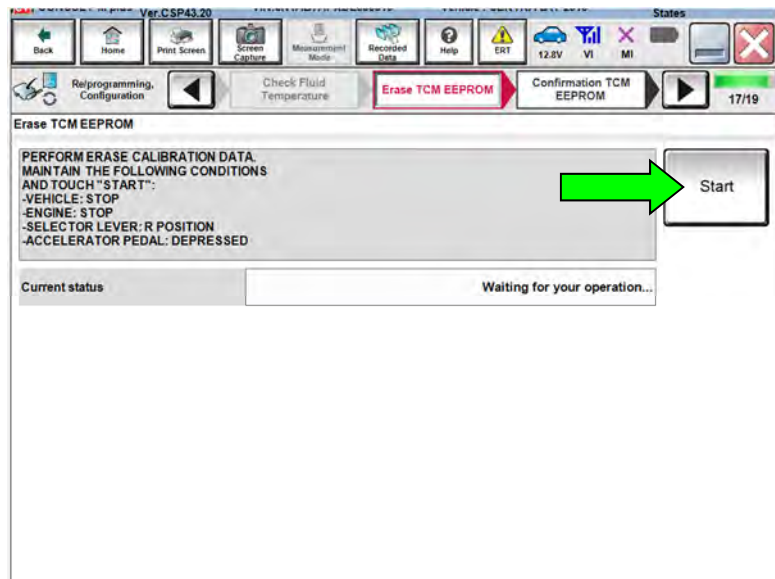

Figure 254

254. Select **Start**.

255. When **COMPLETED** is displayed, select **Next**.

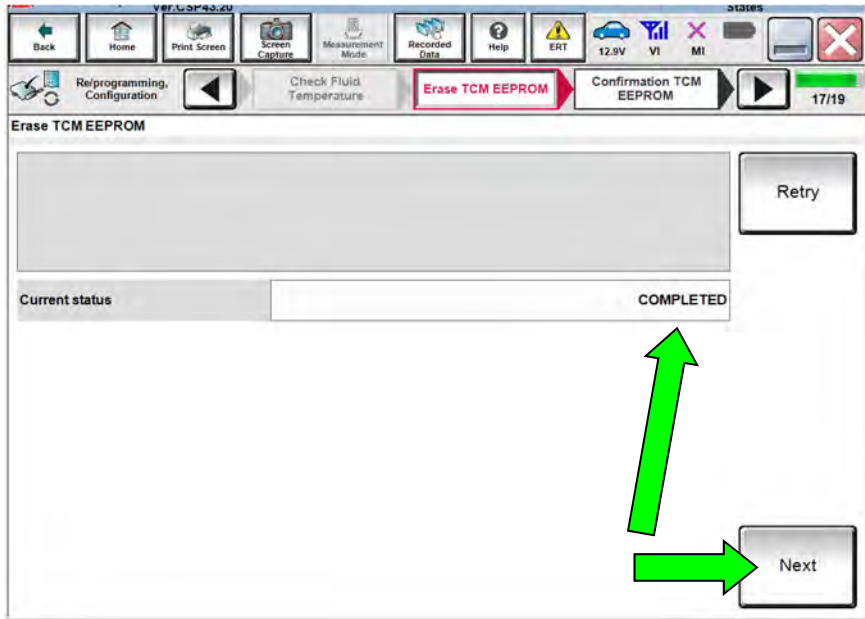

Figure 255

256. Operate the ignition per the on-screen instructions.

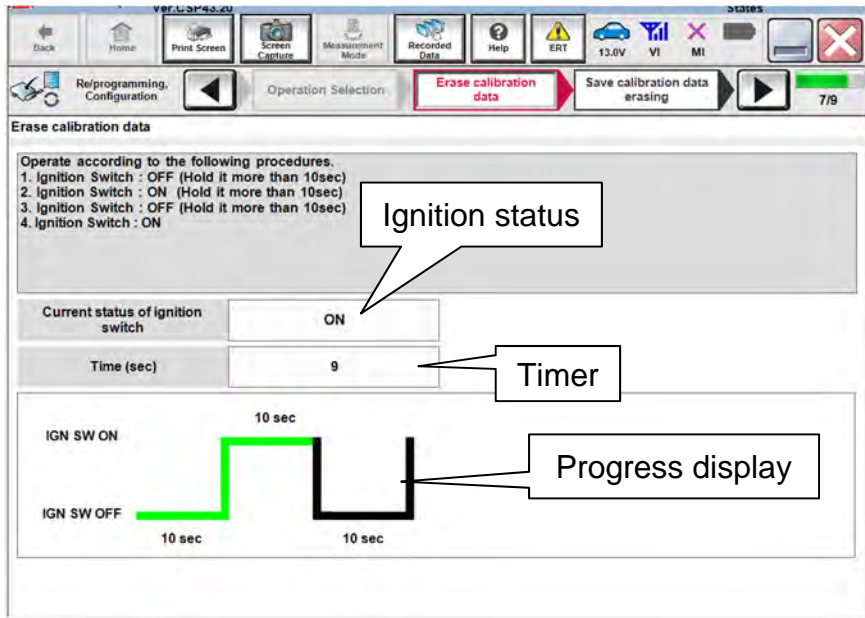

Figure 256

257. When **OK** is displayed, select **Next**.

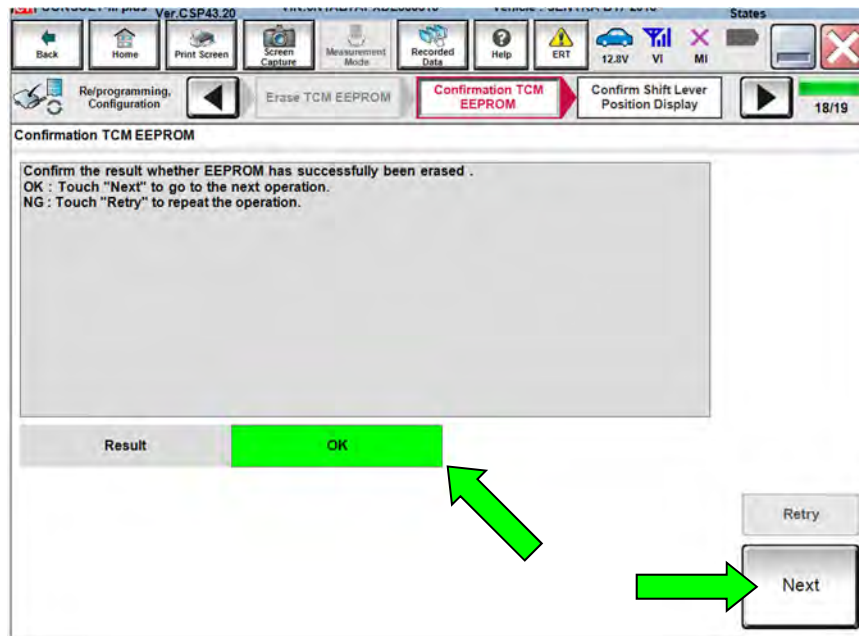

Figure 257

258. Operate the shift selector per the on-screen instructions.

- a. Move the shift selector to **P**, then move **P>R>N>D>P**.
- b. Confirm the center display meter indicates the correct selector position.

259. Select **Next**.

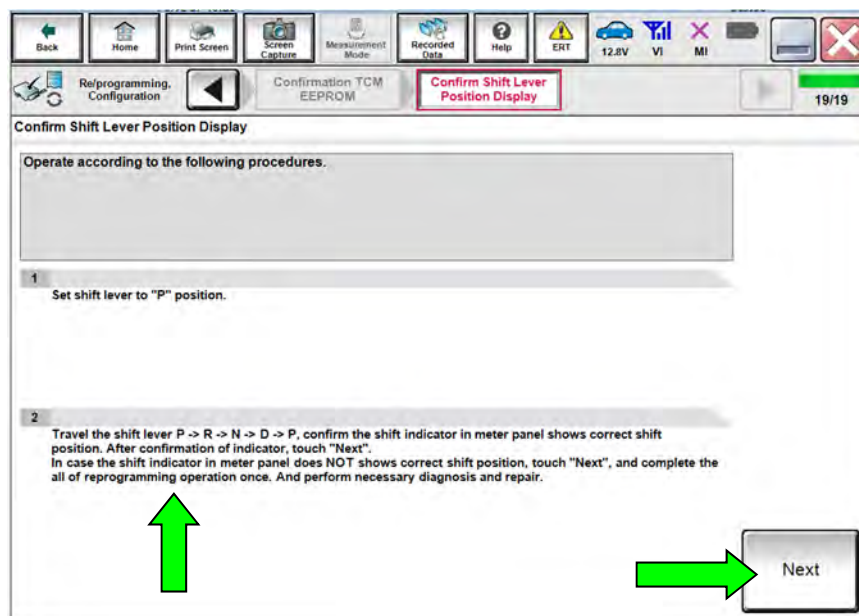

Figure 258

260. Follow the on-screen instructions to erase all DTCs:

- a. Turn the ignition OFF.
- b. Turn the ignition ON.
- c. Wait for DTC erase to complete.

261. Select **Next**.

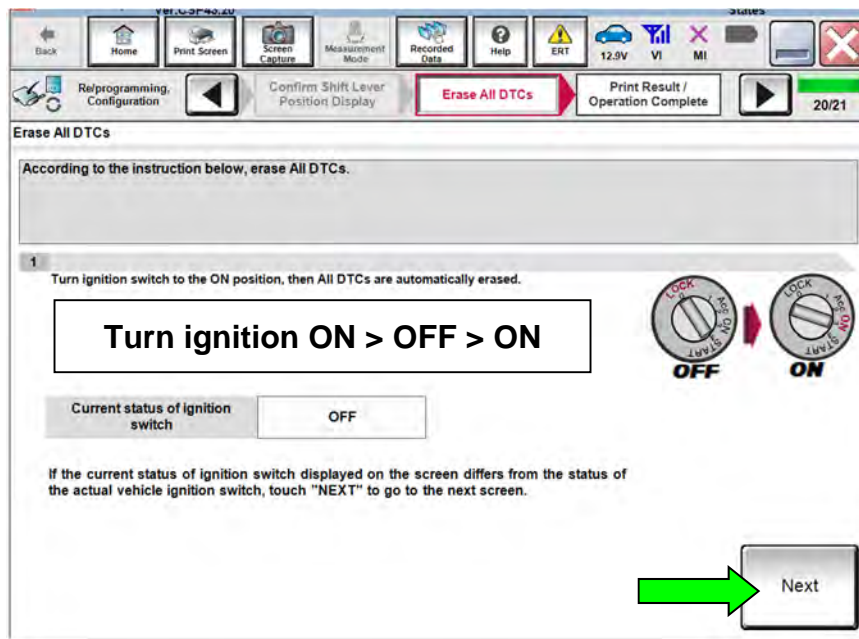

Figure 259

262. When the entire reprogramming process is complete, the screen in Figure 260 on page 125 will display.

263. Verify the before and after part numbers are different.

264. Print a copy of this screen (Figure 260) and attach it to the repair order.

265. Select **Confirm**.

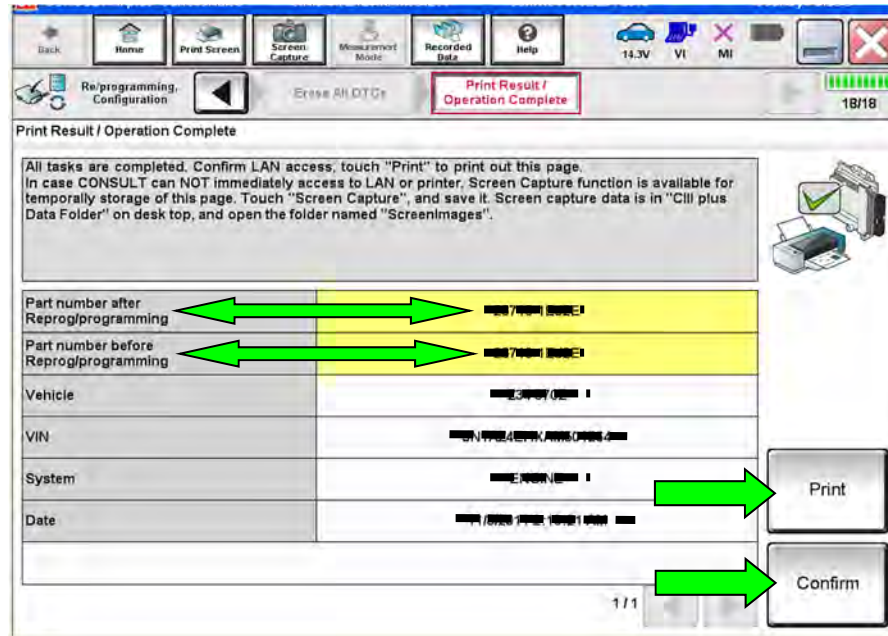

Figure 260

HINT: If you cannot print the above screen:

- Select Screen Capture.
 - Name the file.
 - Save the file in My Documents.
- A copy of the screen is now saved in the CONSULT PC. It can be retrieved and printed at a later time.

TCM Recovery:

Do not disconnect plus VI or shut down C-III plus if reprogramming does not complete.

If reprogramming does not complete and the “!?” icon displays as shown in Figure 261:

- Check battery voltage (12.0–15.5 V).
- Ignition is ON, engine OFF.
- External Bluetooth® devices are OFF.
- All electrical loads are OFF.
- **Select retry and follow the on screen instructions.**
- “Retry” may not go through on first attempt and can be selected more than once.

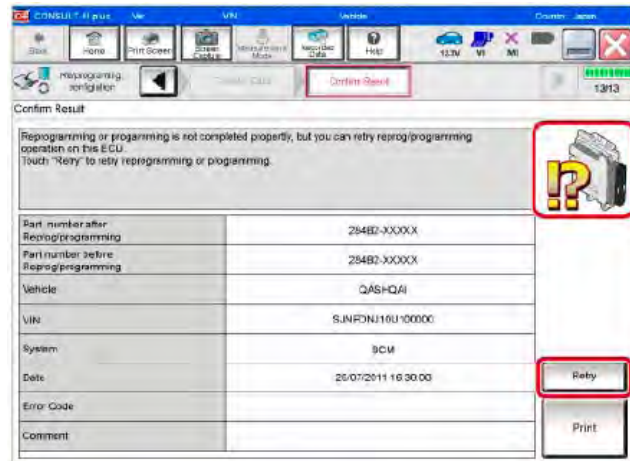

Figure 261

If reprogramming does not complete and the “X” icon displays as shown in Figure 262:

- Check battery voltage (12.0 – 15.5 V).
- CONSULT A/C adapter is plugged in.
- Ignition is ON, engine OFF.
- Transmission is in Park.
- All C-III plus / VI cables are securely connected.
- All C-III plus updates are installed.
- **Select Home, and restart the reprogram procedure from the beginning.**

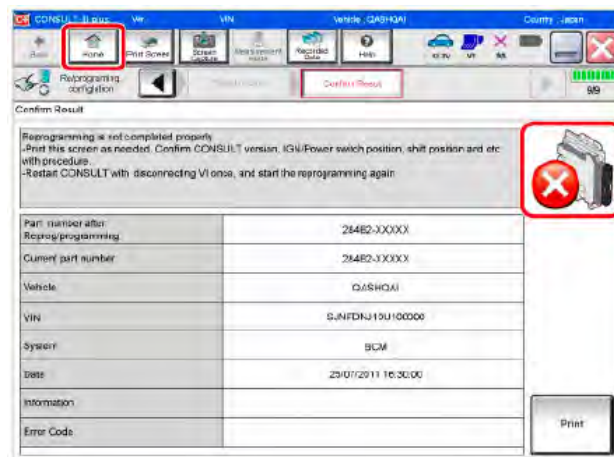

Figure 262

CONTROL VALVE REPLACEMENT

266. Navigate C-III plus to the screen shown in Figure 263.

- **Diagnosis (All Systems) > TRANSMISSION > Work support**

267. Select **CONTROL VALVE REPLACEMENT**.

268. Select **Start**.

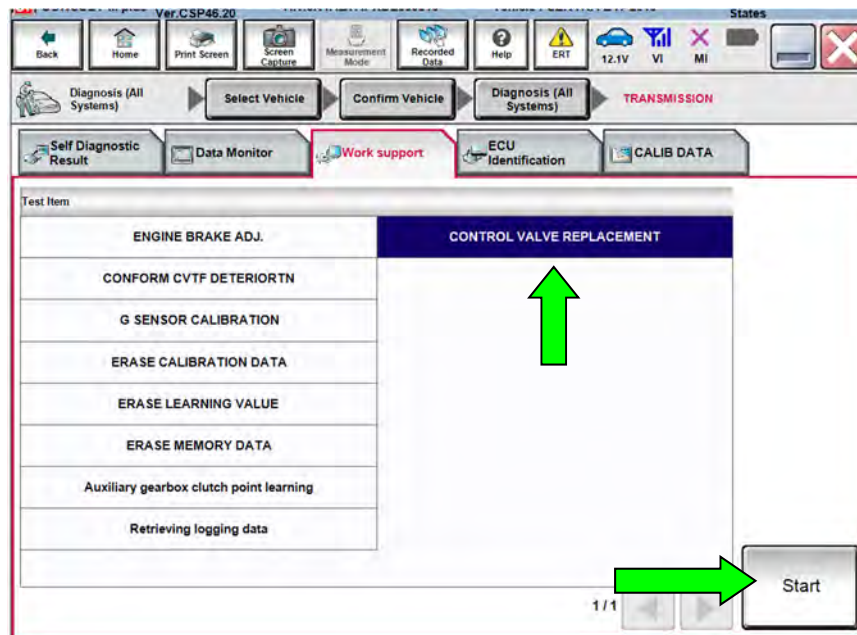

Figure 263

269. Follow the on-screen instructions; maintain the following conditions:
- Turn the ignition ON, with the engine OFF.
 - Press the brake pedal.
 - Press the accelerator pedal between $\frac{1}{4}$ and $\frac{1}{2}$.
 - Put the shift selector in **R**.
270. Select **Start**.

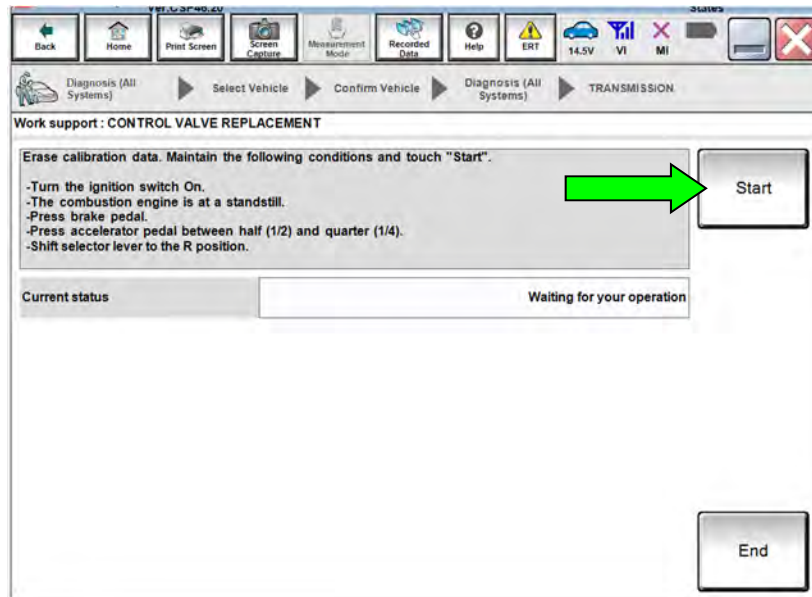

Figure 264

271. Release the accelerator and brake (shift selector remains in **R**).
272. Turn the ignition **OFF**, then wait 10 seconds.

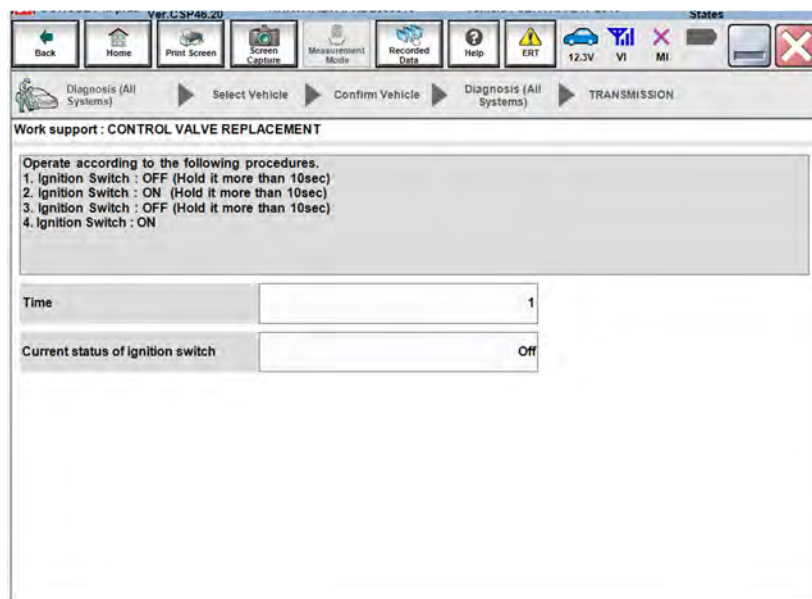

Figure 265

273. Turn the ignition **ON**, then wait 10 seconds.

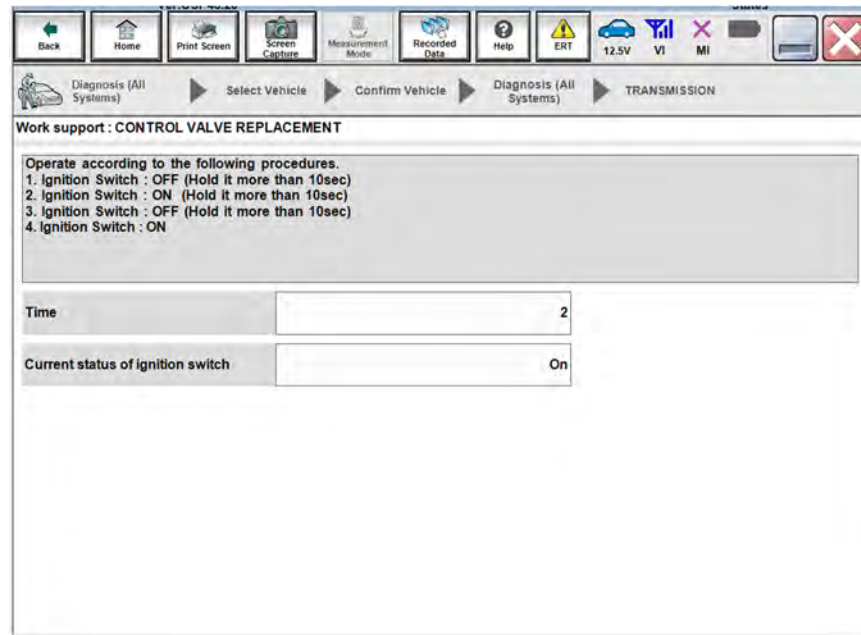

Figure 266

274. Turn the ignition **OFF**, then wait 10 seconds.

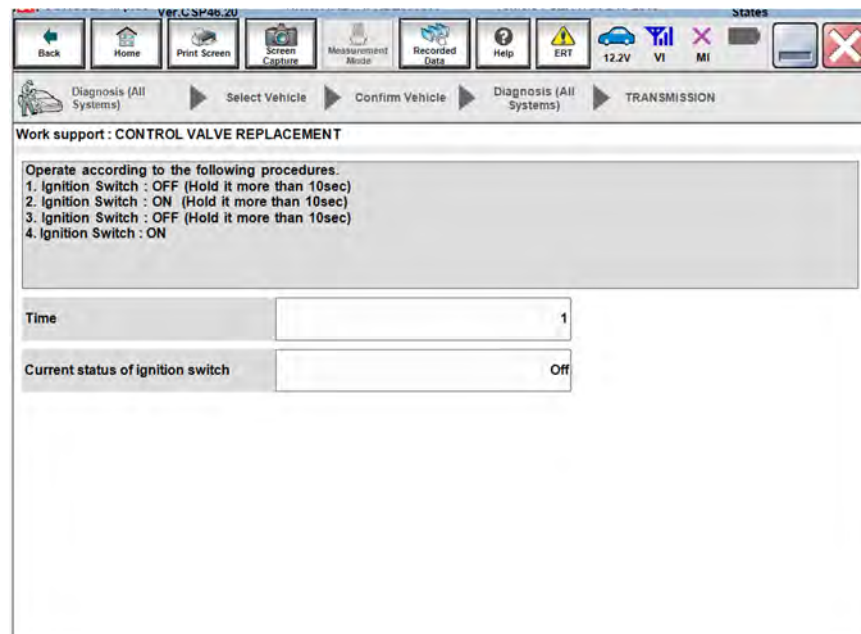

Figure 267

275. Turn the ignition **ON**.

276. Move shift selector to **P**.

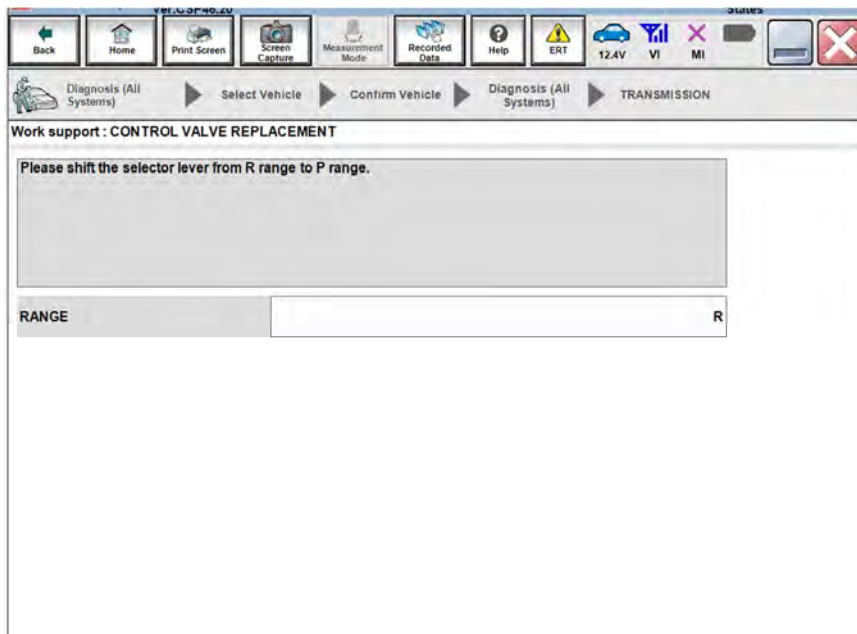

Figure 268

277. When **Completed** is displayed, select **End**.

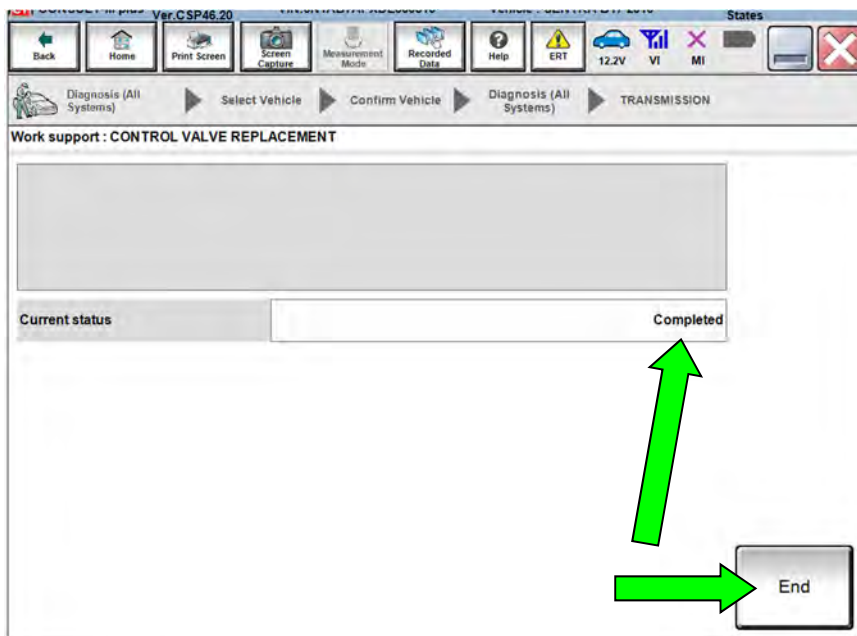

Figure 269

278. Does the pop-up notification in Figure 270 display?

YES: TCM Programming is not correct for the installed control valve. Select **OK**, then return to step 208 on page 107.

NO: Proceed to step 279 on page 132.

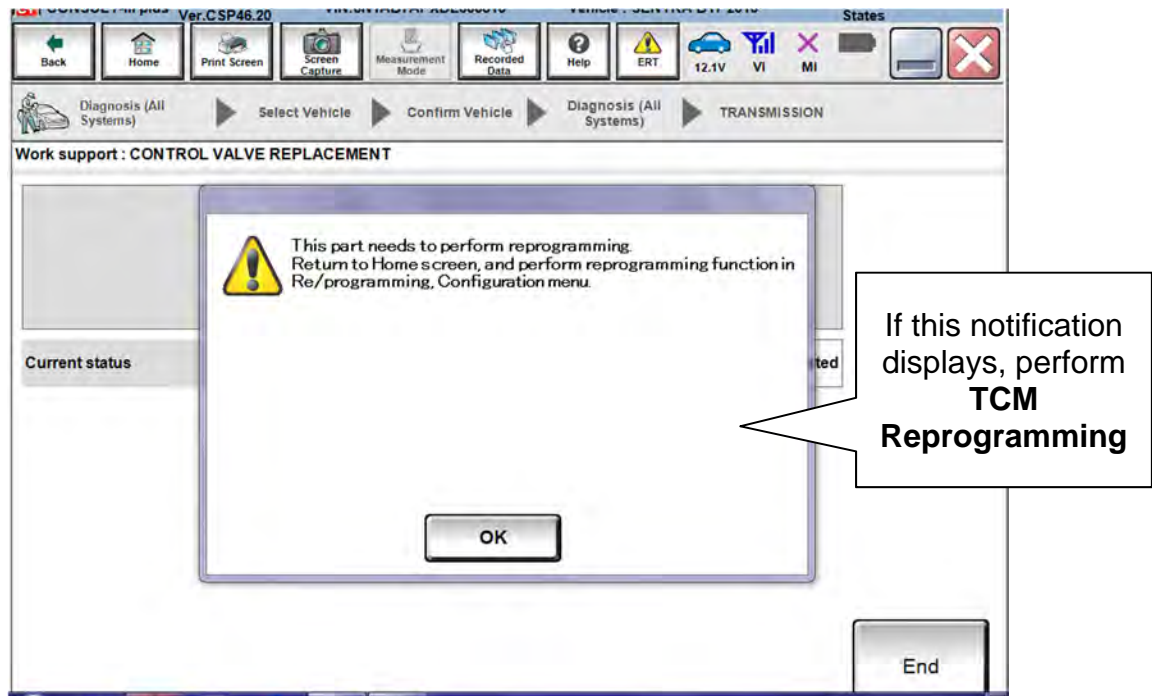

Figure 270

ERASE LEARNING VALUE

279. Navigate C-III plus to the screen shown in Figure 271.

- **Diagnosis (All Systems) > TRANSMISSION > Work support**

280. Select **ERASE LEARNING VALUE**.

281. Select **Start**.

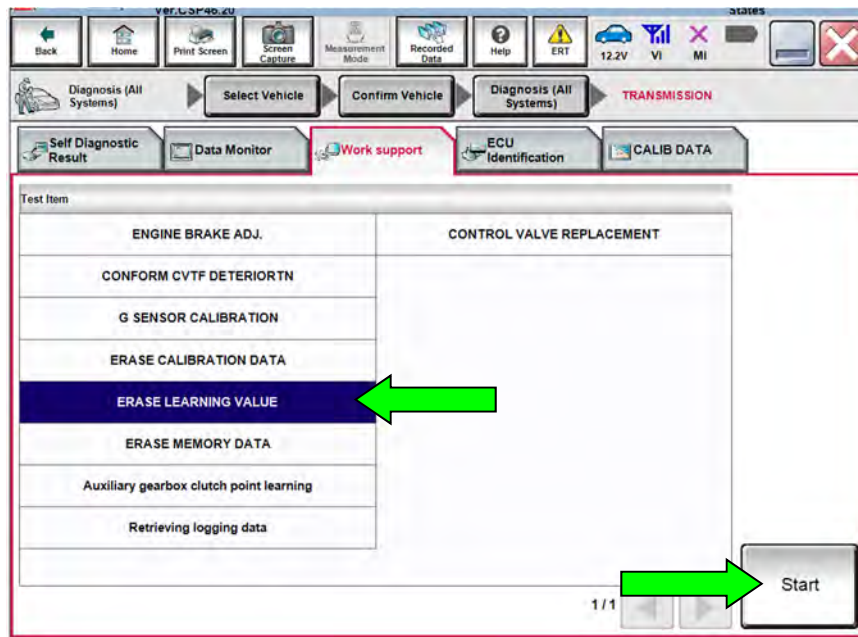

Figure 271

282. Follow the on-screen instructions while maintaining the following conditions:

- a. Parking brake set.
- b. Ignition ON, with the engine OFF.
- c. Put the shift selector in **R**.
- d. Fully depress the accelerator pedal.

283. Select **Start**.

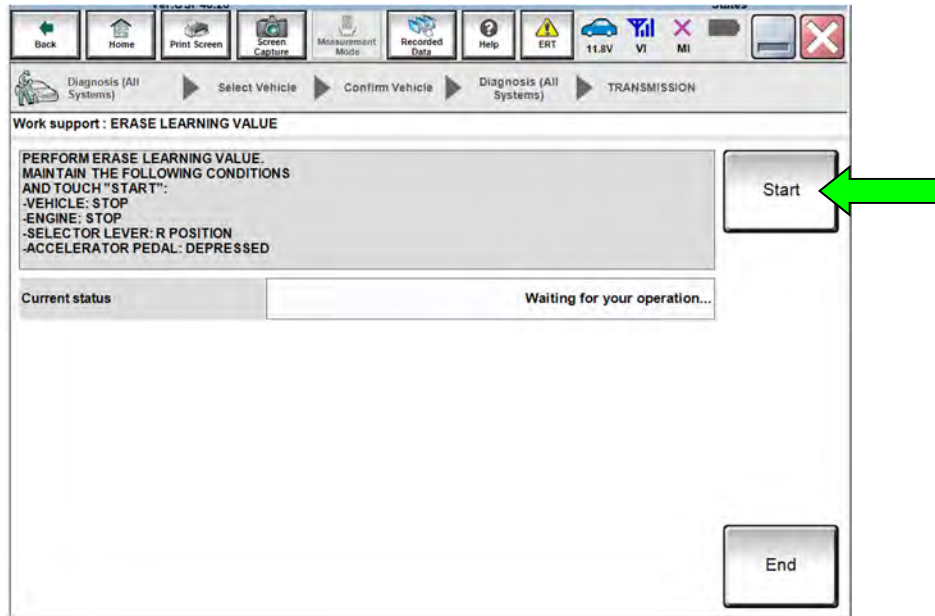

Figure 272

284. When **COMPLETED** is displayed, select **End**.

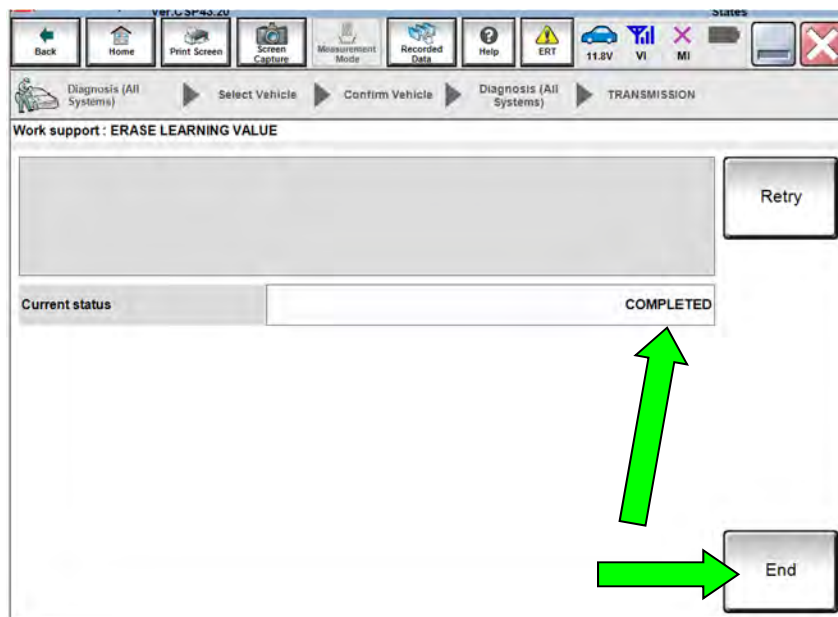

Figure 273

CONFORM CVTF DETERIORTN

285. Navigate C-III plus to the screen shown in Figure 274.

- **Diagnosis (All Systems) > TRANSMISSION > Work support**

286. Select **CONFORM CVTF DETERIORTN**.

287. Select **Start**.

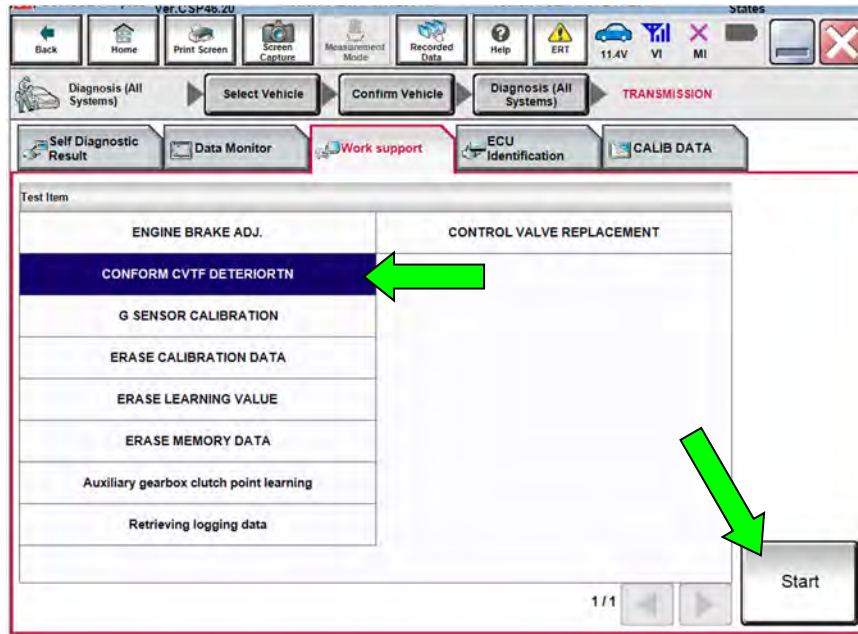

Figure 274

288. Select **Start**.

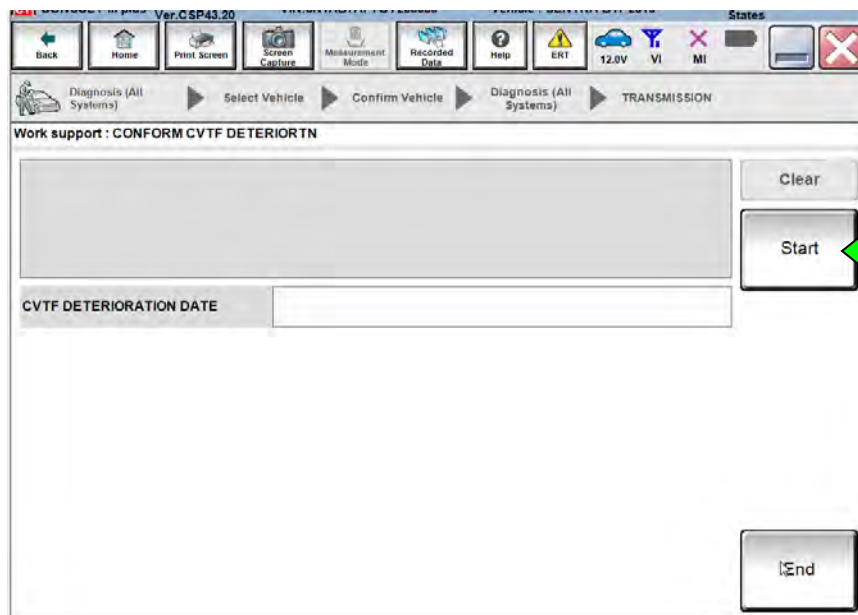

Figure 275

289. Select **Clear**.

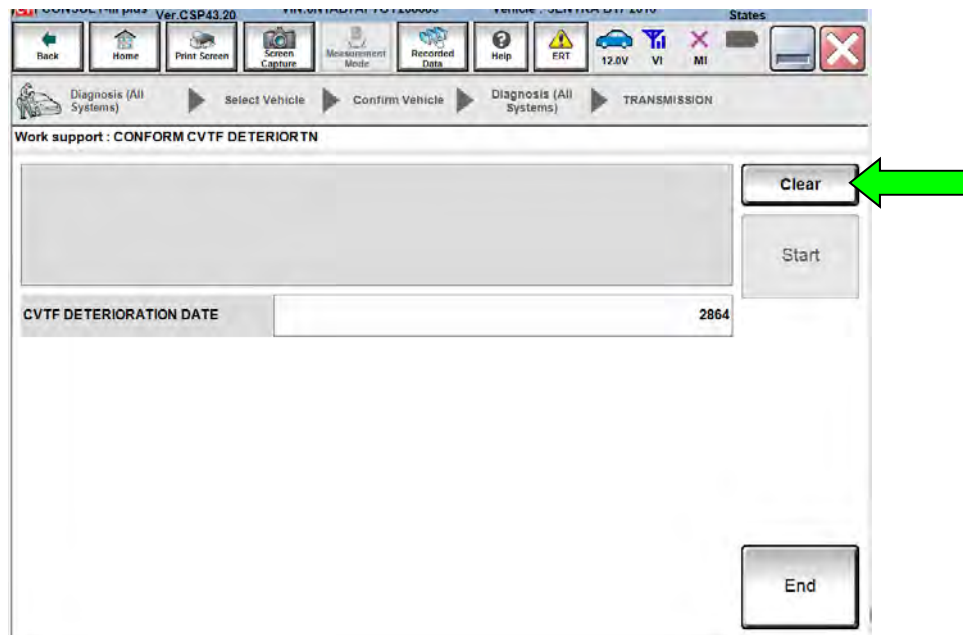

Figure 276

290. Select **Yes**.

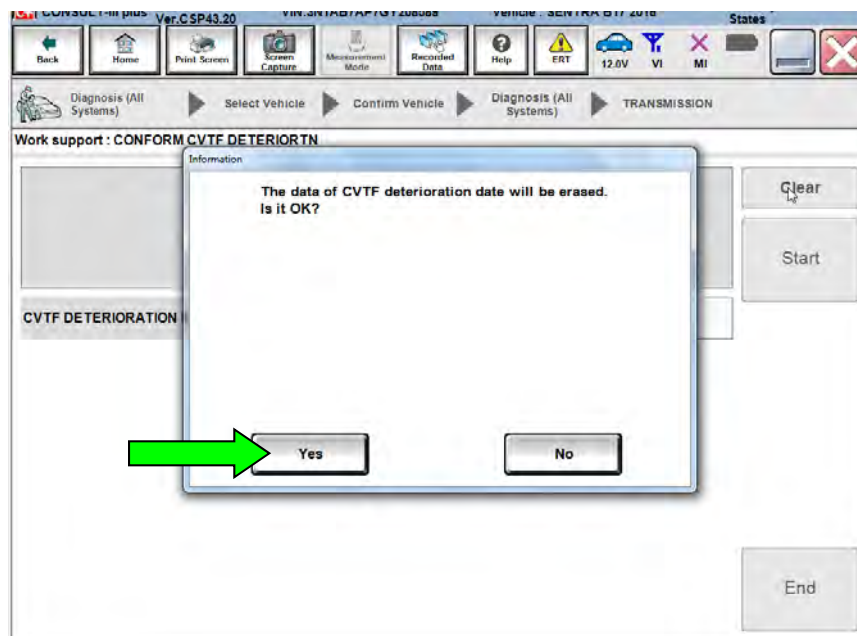

Figure 277

291. When **CVFT DETERIORATION DATE** changes to “0”, select **End**.

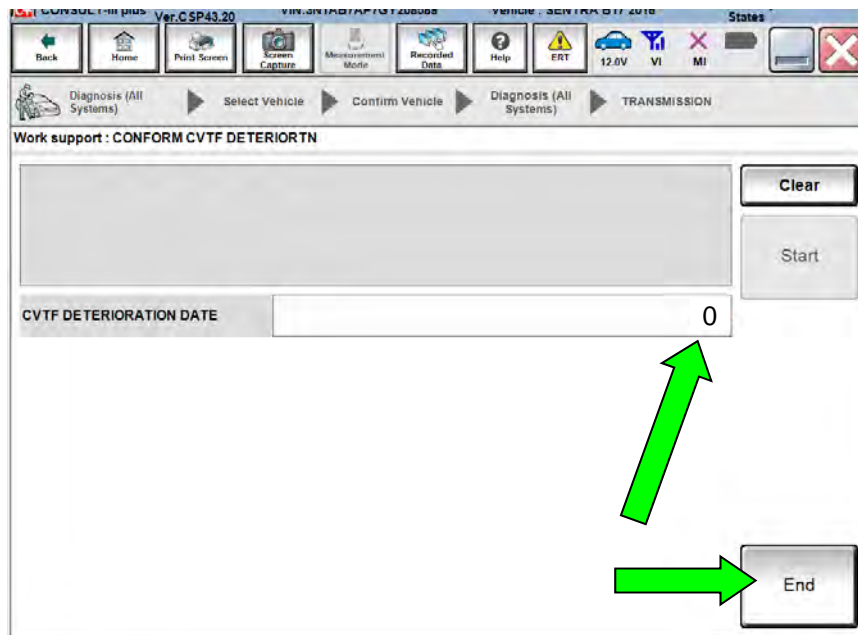

Figure 278

292. Start the engine.

293. Set the parking brake.

294. Turn OFF the A/C.

295. Bring the engine to normal operating temperature range.

296. Confirm the CVT fluid temperature is over 122°F (50°C).

AUXILIARY GEARBOX CLUTCH POINT LEARNING

297. Navigate C-III plus to the screen shown in Figure 279.

- **Diagnosis (All Systems) > TRANSMISSION > Work support**

298. Select **Auxiliary gearbox clutch point learning**.

299. Select **Start**.

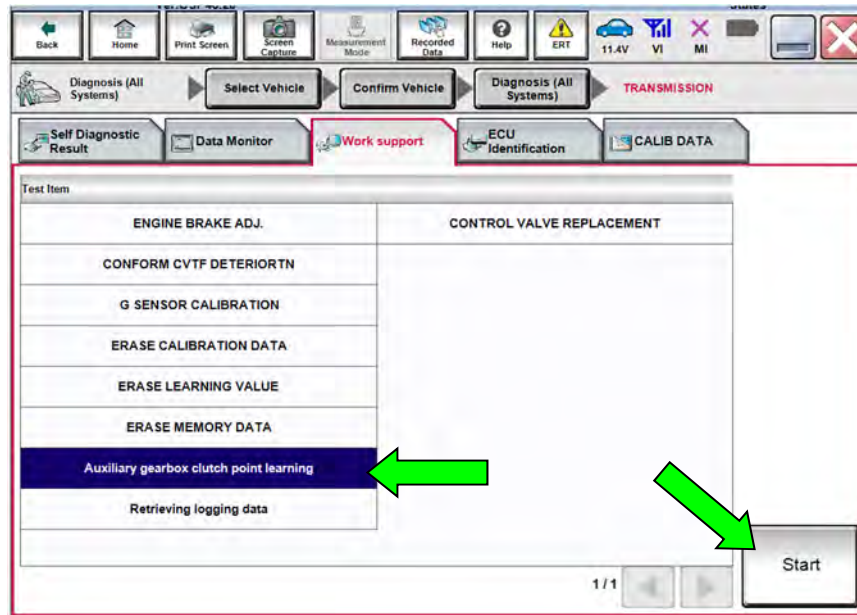

Figure 279

300. Follow the on-screen instructions in Figure 280 and then select **Start**.

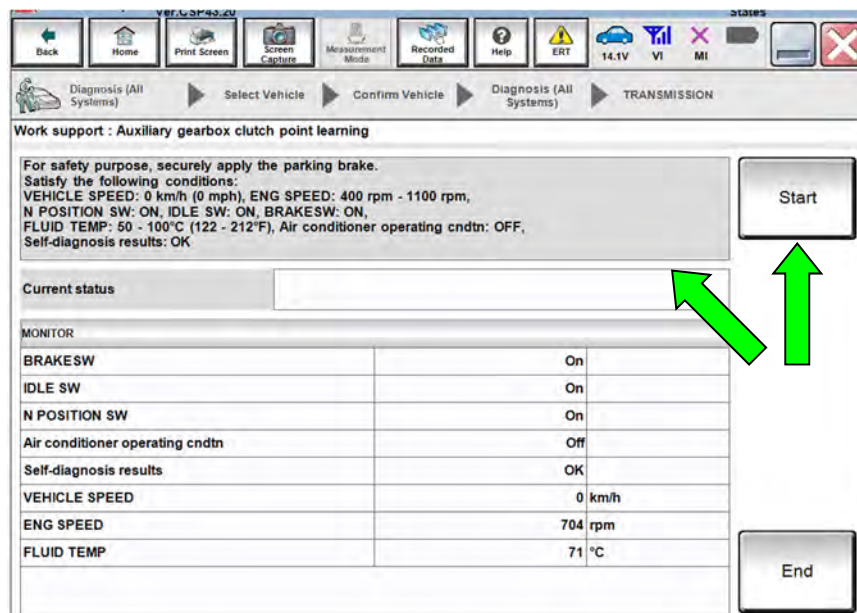

Figure 280

301. With the brake pedal still applied, move the CVT selector lever into the **D** position.

- Figure 281 will be displayed after shifting into **D** position.

NOTE: The Current status will show **EXECUTING**, but until the vehicle is shifted into the **D** position Auxiliary gearbox clutch point learning will not begin.

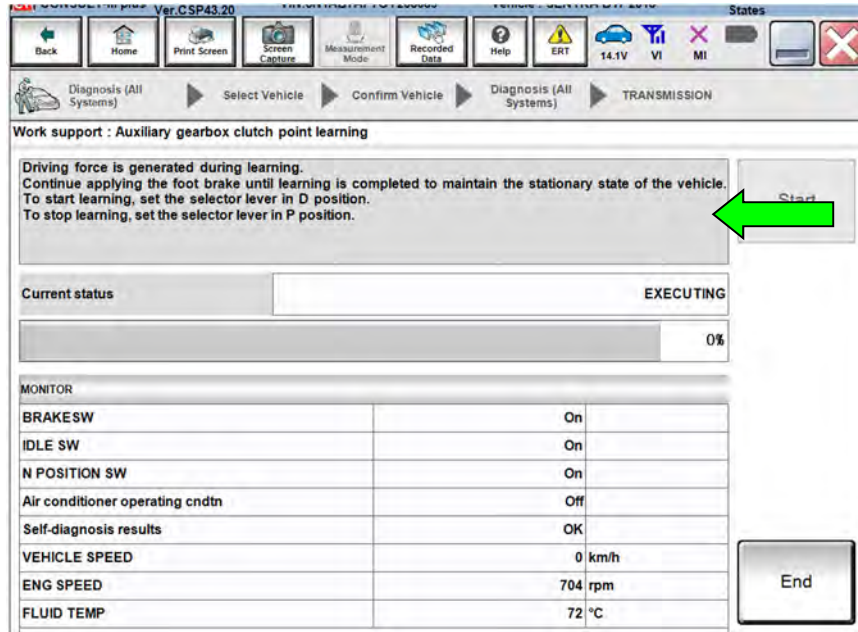

Figure 281

302. Continue to press the brake pedal until the Current status shows "**Completed**" as shown in Figure 283 on page 139.

HINT: This may take several minutes to complete.

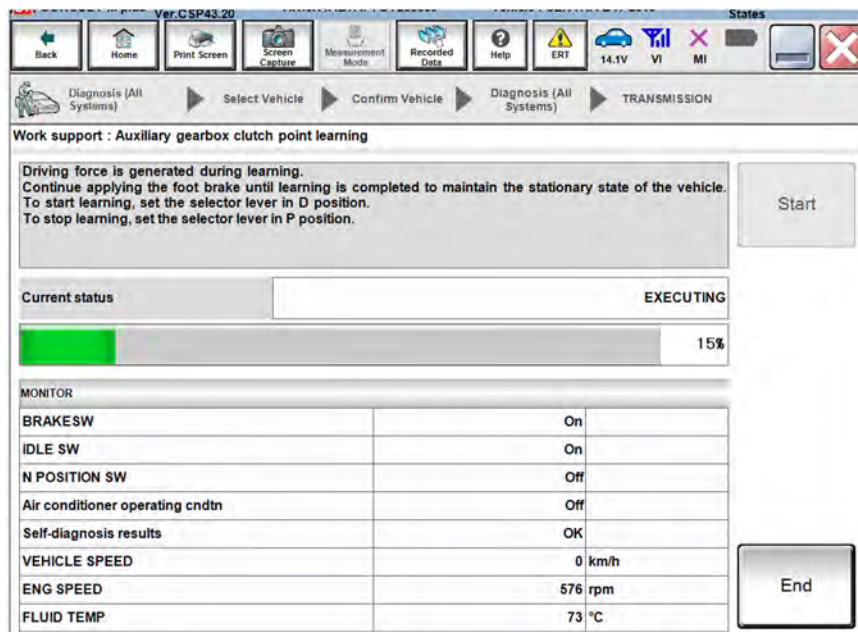

Figure 282

303. When **COMPLETED** is displayed, select **End**.

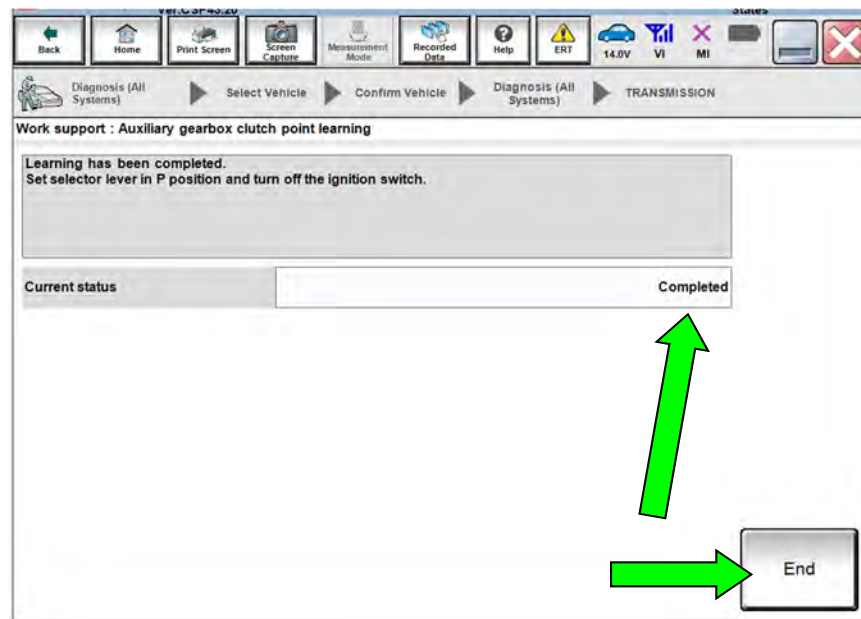

Figure 283

304. Shift the vehicle into Park, turn the ignition OFF and release the brake pedal.

305. Perform **Auxiliary Gearbox Clutch Point Learning** (steps 297 to 304) one additional time (a total of two times).

Erase DTCs

306. Use C-III plus to erase any transmission DTCs that may have stored.

307. Turn OFF C-III plus.

308. Disconnect C-III plus from the vehicle.

309. Verify the CVT operates normally and no abnormal noises are heard during a test drive.

Procedure complete.

PARTS INFORMATION

IMPORTANT: The parts lists apply to both Versa Sedan and Versa Note unless otherwise stated.

Belt and Pulley with Control Valve Repair (Sub-Assembly Repair)

DESCRIPTION	PART #	QUANTITY
KIT-CONTROL VALVE	3170E-X428B	1
KIT-PULLEY	31214-X429D	1
KIT-OIL PUMP	31340-X429E	1
Loctite 5460 Sealant (1) (2)	999MP-LT5460P	(3) (4)
Nissan NS-3 CVT Fluid (1) (2)	999MP-CV0NS3	As needed
Additional Engagement Tool O-Rings (5)	11440	As needed
Lens Swab packet	J-51963	(6)

****Single use parts that are not included in the above kits****

DESCRIPTION	PART # PREFIX	QUANTITY
GASKET - INTAKE MANIFOLD (throttle body gasket) (Versa Note only)	16175	1
GASKET - INTAKE MANIFOLD	14035	1
PIN - COTTER	40073	2
NUT - LOCK, FRONT WHEEL BEARING	40262	2
NUT (steering knuckle)	01223	2
NUT (stabilizer connecting rod to front strut)	01225	2
NUT (outer socket)	01223	2
CLAMP (CVT oil cooler hose)	21639	2
CLAMP (for water hose) (Versa Note only)	16439	2
SEAL - O RING (fill tube)	31084	1
WASHER - SPRING (manual plate)	08915	1
NUT - HEX (manual plate)	08911	1
WASHER-DRAIN (CVT Oil Pan Drain Plug Gasket)	11026	1

Refer to the footnotes on page 142.

PARTS INFORMATION (continued)

IMPORTANT: The parts lists apply to both Versa Sedan and Versa Note unless otherwise stated.

Control Valve only Repair

DESCRIPTION	PART #	QUANTITY
KIT-CONTROL VALVE	3170E-X428B	1
Nissan NS-3 CVT Fluid (1) (2)	999MP-CV0NS3	As needed
Additional Engagement Tool O-Rings (5)	11440	As needed
Lens Swab packet	J-51963	(6)

******Single use parts that are not included in the above kit******

DESCRIPTION	PART # PREFIX	QUANTITY
WASHER – SPRING (manual plate)	08915	1
NUT - HEX (manual plate)	08911	1
SEAL– O Ring (secondary speed sensor)	31526	1
WASHER-DRAIN (CVT Oil Pan Drain Plug Gasket)	11026	1

Refer to the footnotes on page 142.

PARTS INFORMATION (continued)

IMPORTANT: The parts lists apply to both Versa Sedan and Versa Note unless otherwise stated.

CVT Assembly Replacement

DESCRIPTION	PART #	QUANTITY
CVT Assembly	(7)	1
Nissan NS-3 CVT Fluid (1) (2)	999MP-CV0NS3	As needed

****Single use parts that are not included with the CVT Assembly****

DESCRIPTION	PART # PREFIX	QUANTITY
GASKET - INTAKE MANIFOLD (throttle body gasket) (Versa Note only)	16175	1
GASKET - INTAKE MANIFOLD	14035	1
PIN - COTTER	40073	2
NUT - LOCK, FRONT WHEEL BEARING	40262	2
NUT (steering knuckle)	01223	2
NUT (stabilizer connecting rod to front strut)	01225	2
NUT (outer socket)	01223	2
CLAMP (CVT oil cooler hose)	21639	2
CLAMP (for water hose) (Versa Note only)	16439	2
SEAL - O RING (fill tube)	31084	1
WASHER-DRAIN (CVT Oil Pan Drain Plug Gasket)	11026	1

- (1) For warranty repairs, Nissan NS-3 CVT Fluid and Loctite 5460 Sealant **must** be used. For customer pay repairs, Nissan NS-3 CVT Fluid and Loctite 5460 Sealant or their equivalents are recommended.
- (2) Nissan NS-3 CVT Fluid and Loctite 5460 Sealant can be ordered through the Nissan Maintenance Advantage program: Phone: 877-NIS-NMA1 (877-647-6621) or Website: Order via link on dealer portal www.NNAnet.com and click on the "Maintenance Advantage" link.
- (3) One container of Loctite 5460 Sealant is good for approximately 5 repairs. This sealant is not included in any kit.
- (4) Bill out Loctite 5460 Sealant (or equivalent) under **expense code 008**. Do not include the Loctite 5460 Sealant part number on the claim.
- (5) Engagement tool will initially come with 10 O-rings. Additional O-rings are available from Tech•Mate online: www.nissantechmate.com or by phone: 1-800-662-2001.
- (6) Shop supply.
- (7) Refer to the Electronic Parts Catalog for the correct part number.

CLAIMS INFORMATION

Submit a Primary Part (PP) type line claim using the following claims coding:

If pan inspection shows excessive large debris and CVT is replaced

OPERATION	PFP	OP CODE	SYM	DIA	FRT
Inspect CVT Pan for Excessive Debris = NG	(1)	JX49AA	ZE	32	0.3
Replace CVT		JD01AA JD023A			(2)

- (1) Reference the Electronic Parts Catalog and use the applicable CVT assembly part number as the Primary Failed Part (PFP).
- (2) Reference the current Nissan Warranty Flat Rate Manual and use the indicated Flat Rate Time (FRT).

OR

If P17F0 IS stored and Sub-assembly is replaced (no belt or pulse rotor inspection required)

OPERATION	PFP	OP CODE	SYM	DIA	FRT
CVT R&R	(1)	JD01AA JD023A	ZE	32	(2)
Replace Control Valve with P17F0 stored		JX56AA			0.8
Replace CVT Sub-assembly		JX45AA			3.0
Reprogram TCM		JE99AA			(2)

- (1) Reference the PARTS INFORMATION Table and use the Kit-Pulley Part Number as the Primary Failed Part (PFP).
- (2) Reference the current Nissan Warranty Flat Rate Manual and use the indicated Flat Rate Time (FRT).

OR

If P17F0 is **NOT** stored, belt inspection is performed, and Sub-assembly is replaced (belt inspection shows signs of belt slip, NG)

OPERATION	PFP	OP CODE	SYM	DIA	FRT
CVT R&R	(1)	JD01AA JD023A	ZE	32	(2)
Inspect CVT Belt, Belt = NG (Includes control valve R&I)		JX36AA			1.2
Replace CVT Sub-assembly		JX45AA			3.0
Reprogram TCM		JE99AA			(2)

- (1) Reference the PARTS INFORMATION Table and use the Kit-Pulley Part Number as the Primary Failed Part (PFP).
- (2) Reference the current Nissan Warranty Flat Rate Manual and use the indicated Flat Rate Time (FRT).

CLAIMS INFORMATION continued on next page.

CLAIMS INFORMATION (continued)

OR

If P17F0 is **NOT** stored, belt and pulse rotor inspection are performed, and Sub-assembly is replaced (belt inspection shows NO signs of belt slip - OK, but pulse rotor inspection is abnormal, NG).

OPERATION	PFP	OP CODE	SYM	DIA	FRT
CVT R&R	(1)	JD01AA JD023A	ZE	32	(2)
CVT Belt and Pulse Rotor Inspection with C/V R&I		JX61AA			1.4
Replace CVT Sub-assembly		JX45AA			3.0
Reprogram TCM		JE99AA			(2)

- (1) Reference the PARTS INFORMATION Table and use the Kit-Pulley Part Number as the Primary Failed Part (PFP).
- (2) Reference the current Nissan Warranty Flat Rate Manual and use the indicated Flat Rate Time (FRT).

EXPENSE CODE

EXPENSE CODE	DESCRIPTION	MAX AMOUNT
008	Sealant	\$12.46

OR

If P17F0 is **NOT** stored, belt inspection and pulse rotor inspection are performed, and only control valve is replaced (belt inspection shows NO signs of belt slip - OK, and pulse rotor inspection is not abnormal - OK).

OPERATION	PFP	OP CODE	SYM	DIA	FRT
Inspect CVT Belt, Belt = OK	(1)	JX37AA	ZE	32	0.4
Pulse Rotor Inspection		JX60AA			0.2
Replace Control Valve (Valve Body)		JD48AA			(2)
Reprogram TCM		JE99AA			(2)

- (1) Reference the PARTS INFORMATION Table and use the Kit-Control Valve Part Number as the Primary Failed Part (PFP).
- (2) Reference the current Nissan Warranty Flat Rate Manual and use the indicated Flat Rate Time (FRT).

NOTE: FRT allows adequate time to access DTCs. No other diagnostic procedures subsequently required. Do NOT claim any diagnostic OP Codes with this claim.

KIT PARTS REFERENCE TABLE

NOTE:

- This table is for reference only. Part numbers listed cannot be ordered individually.
- These part numbers are for identification of the correct part within the kit (part number is listed on the bag for each individual part).
- Some parts have more than one part number listed. In this case, one of the part numbers listed will be in the kit.

KIT-CONTROL VALVE (3170E-X428B) PARTS REFERENCE (Kit Content)

REFERENCE #	DESCRIPTION	PART NUMBER	QTY:
1	VALVE ASSY - CONTROL (Control valve)	31705-X428B	1
2	GASKET - OIL PAN (Oil pan gasket)	31397-3JX0A	1
3	STRAINER ASSY - OIL, AUTO TRANS (Oil pan strainer)	31728-3XX0A or 31728-3XX0B or 31728-3JX0B	1

KIT-PULLEY (31214-X429D) PARTS REFERENCE (Kit Content)

REFERENCE #	DESCRIPTION	PART NUMBER	QTY:
4	PULLEY ASSY (Sub assembly: Belt & Pulley)	31209-X429D	1
5	SNAP RING KIT (Snap ring kit)	31506-3JX8B	1
6	BOLT (Side cover bolts)	31377-3JX0E or 31377-X420B or 31377-3XX2B or 31377-X424C	11
7	SEAL - O RING (Input shaft O ring)	31526-3MX0A or 31526-X420C or 31526-3XX0C	1
8	SEAL - O RING	31526-8E000 or 31526-28X0C	2

KIT PARTS REFERENCE TABLE (Continued)

KIT-OIL PUMP (31340-X429E) PARTS REFERENCE (Kit Content)

REFERENCE #	DESCRIPTION	PART NUMBER	QTY:
9	BOLT (Torque converter case bolts)	31377-X420B or 31377-3JX0E or 31377-3XX2B or 31377-X424C	19
10	SEAL - LIP (Lip seal)	31528-1XZ0A or 31528-1XA01 or 31528-1XX0A	1
11	SEAL-O RING (Case O ring)	31526-X420B or 31526-50X0D or 31526-3JX0B or 31526-3XX0B	1
12	PIN - RET (Manual shaft roll pin)	31906-1XF0A	1
13	PUMP ASSY - OIL (Oil pump)	31340-X420B or 31340-3JX0D or 31340-X420A or 31340-3XX0B	1
14	GSKT - OIL PUMP (Oil pump gasket)	31366-3JX0B or 31366-3JX0A or 31366-3XX0A	1
15	SEAL - O RING (Oil filter cover O ring)	31526-3JX3A or 31526-3JX1B	1
16	FLTR ASSY - OIL,AUTO TRANS (Oil filter)	31726-28X0A or 31726-3JX0A or 31726-3XX0A	1
17	SEAL ASSY - OIL (Torque converter Seal)	31375-3JX1A	1
18	SEAL - OIL,DIFF (Axle seals)	38342-3VX0A	2
19	SEAL - O RING (Primary/Secondary/Output Sensor O-ring)	31526-1XG0C	3
20	SLEEVE - OIL DIST	31374 80X01	1
21	RING - SEAL	31525 3JX0B or 31525 X420A	2

PART KITS VISUAL REFERENCE

- Figure 284 and Figure 285 show the smaller components of individual kits.
- KIT - CONTROL VALVE is not shown.

KIT - PULLEY. Sub-assembly not shown

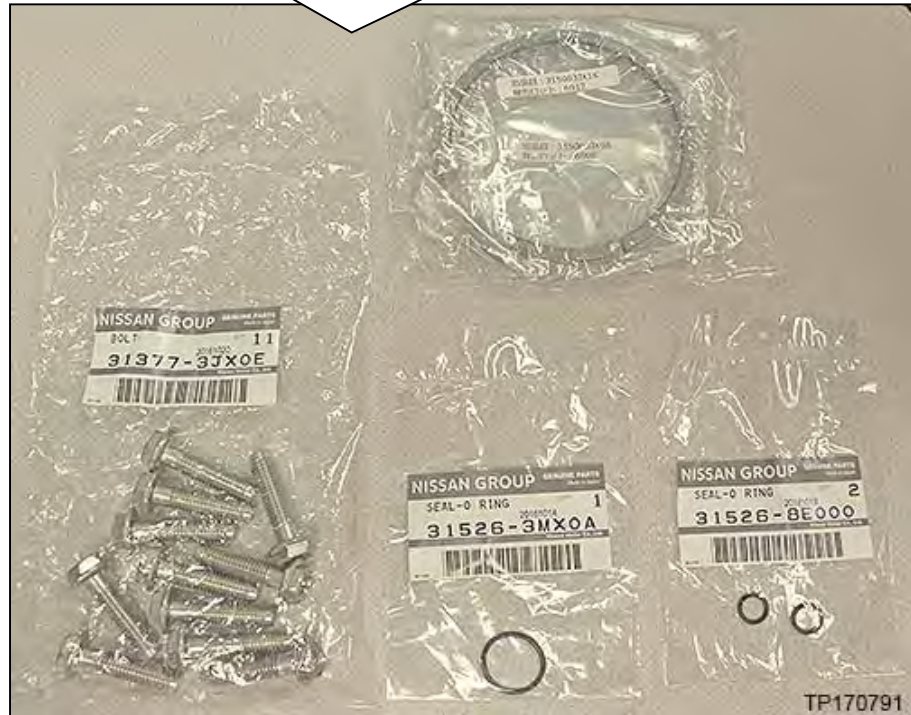

Figure 284



Figure 285

CVT Assembly Replacement Approval Procedures

- If CVT inspection **indicates CVT assembly replacement** is required:
 - a. Complete the PCC CVT Preauthorization Form in ASIST.
 - b. Attach the required video (15 seconds or less) to the CVT Preauthorization Form.
 - Failure to submit a continuous video showing evidence of abnormalities and the VIN will cause immediate denial of request for CVT unit replacement.
 - c. Call the PCC for authorization at **800-973-9992 (opt 2)**.

IMPORTANT: Make sure the video has a clear image of the VIN on the F.M.V.S.S. certification label (VIN label).

AMENDMENT HISTORY

PUBLISHED DATE	REFERENCE	DESCRIPTION
May 19, 2020	NTB20-036	Original bulletin published
June 25, 2020	NTB20-036a	Repair Overview on page 3 revised