



GROUP
Product Improvement

MODEL
See Model List
on Page 1

NUMBER
PI1803Y/Z (Rev 2, 06/09/2020)

DATE
March 2020

PRODUCT IMPROVEMENT CAMPAIGN

**SUBJECT: ENGINE REPLACEMENT INSTRUCTIONS
FOR DTC P1326 (PI1803Y/Z)**

* NOTICE

This bulletin has been revised to include additional information. New/revised sections of this bulletin are indicated by a black bar in the margin area.

This bulletin provides information related to the Technical Service Bulletin previously published in July 2018 (PI1803, Rev 10, 03/16/2020) titled "Knock Sensor Detection System - ECU Logic Improvement". Specifically, this bulletin provides instructions on which procedures to follow if, after installation of the KSDS, any one of the subject vehicles below return to the dealer with Diagnostic Trouble Code (DTC) P1326 (Knock Signal Range/Performance).

Model List:

Year	Model	Engine	Production Date
2011-2013	Optima (QF/TF)	2.4L & 2.0L T-GDI	8/12/10 – 9/27/13
2014	Optima (QF)	2.4L & 2.0L T-GDI	8/28/13 – 5/15/14
2011-2013	Sportage (SL)	2.0L T-GDI	12/30/10 – 8/30/13
2012-2014	Sorento (XMa)	2.4L GDI	4/19/11 – 2/10/14

If DTC P1326 is present, first perform the bearing clearance inspection with the Engine Bearing Clearance Tester device (SST KQ231-2T110QQK). This device checks the rod bearing clearance by placing air and vacuum into the cylinder block. Measure the bearing clearance and follow the instructions in this bulletin. Refer to the flow chart found on page 2, then follow the appropriate procedure as outlined in this bulletin.

A [Vehicle Diagnosis Number \(VDN\)](#) must be created with or without DTC P1326 after scanning for DTCs, prior to performing PI1802Y/Z. If a VDN is not created, Warranty claim submission issues WILL occur.

Before conducting the procedure, verify the vehicle is included in the list of affected VINs.

* NOTICE

To ensure complete customer satisfaction, always remember to refer to WebDCS Warranty Coverage (validation) Inquiry Screen (Service → Warranty Coverage → Warranty Coverage Inquiry) for a list of any additional campaigns that may need to be performed on the vehicle before returning it to the customer.

Printed TSB copy is for reference only; information may be updated at any time.
Always refer to KGIS for the latest information.

Circulate To: General Manager Service Manager Parts Manager
 Service Advisors Technicians Body Shop Manager Fleet Repair

Flowcharts:

Choose the applicable flowchart based on the initial inspection and required DTC scan with VDN record:

- **Scenario 1** – Vehicle is in with DTC P1326 stored (A).
- **Scenario 2** – Vehicles is in with no DTC P1326 stored but engine is knocking or seized (B).
- **Scenario 3** – Vehicle is in with DTC P1326 stored and also engine is making noise or seized (A).

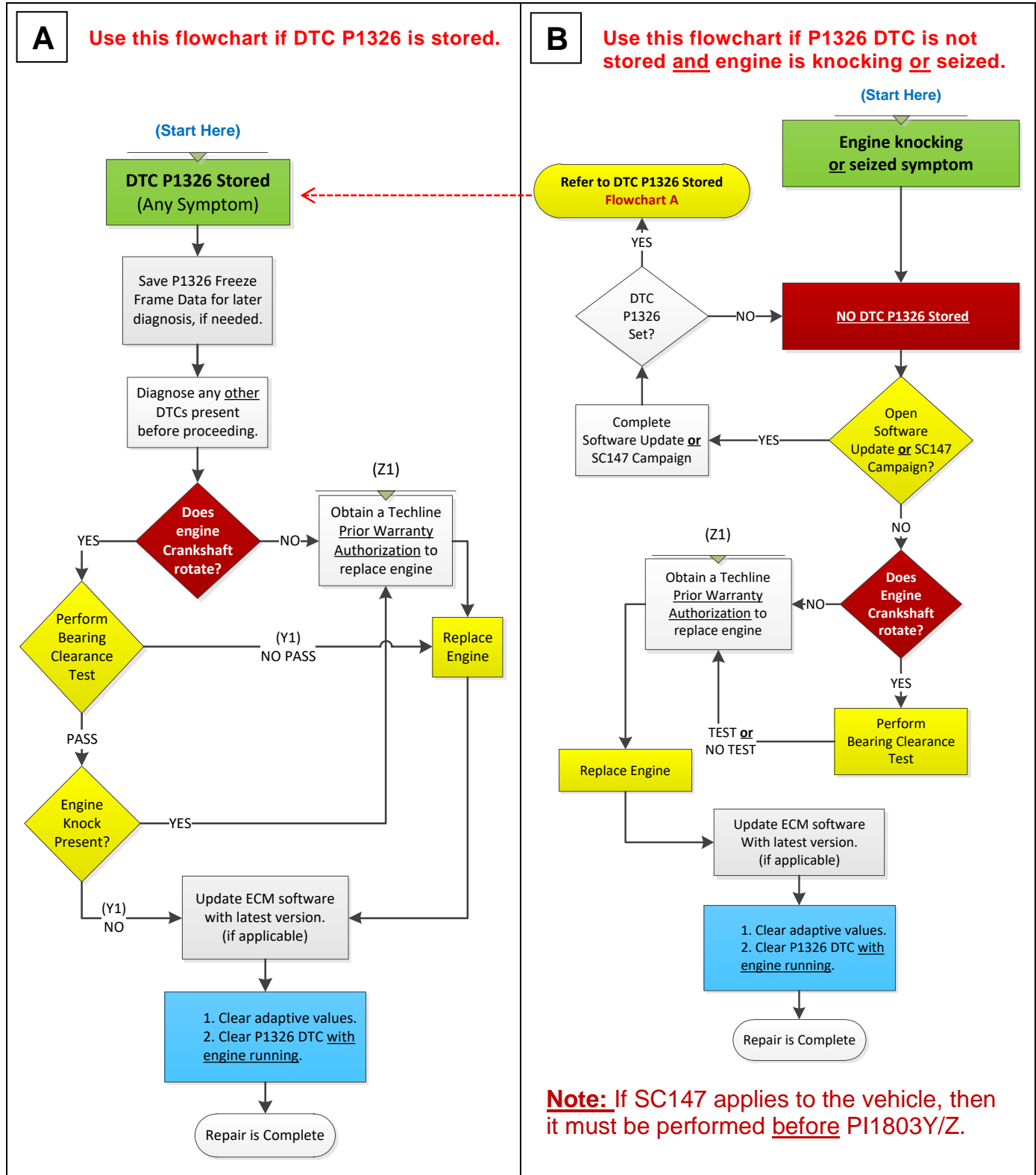

Note: If any concerns arise after completing the flow chart, open a Techline case online.

Printed TSB copy is for reference only; information may be updated at any time. Always refer to KGIS for the latest information.



SUBJECT: ENGINE REPLACEMENT INSTRUCTIONS FOR DTC P1326 (PI1803Y/Z)
Bearing Clearance Inspection Procedure:

1. Open the hood and remove the engine cover.

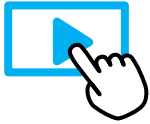

[Bearing Clearance Test Video](#)

ⓘ IMPORTANT

Have the SST Engine Bearing Clearance kit ready. Place it on a table/cart next to the vehicle and use a fender cover.

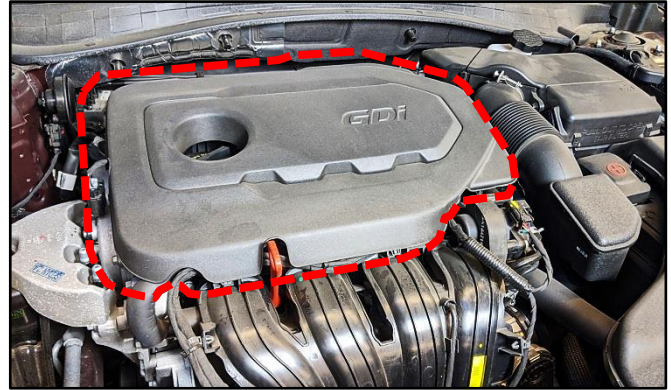

For troubleshooting assistance, contact the GITA Support Line at: (888) 542-4371.

2. Remove the four (4) spark plugs (A) by referring to the “Maintenance → Power Train → Spark Plug → Repair procedures (Replacement)” in the applicable Shop Manual on KGIS.

Tightening torque for Spark Plugs:
10.9 – 18.0 lb.ft (14.7 – 24.5 N.m,
1.5 – 2.5 kgf.m)

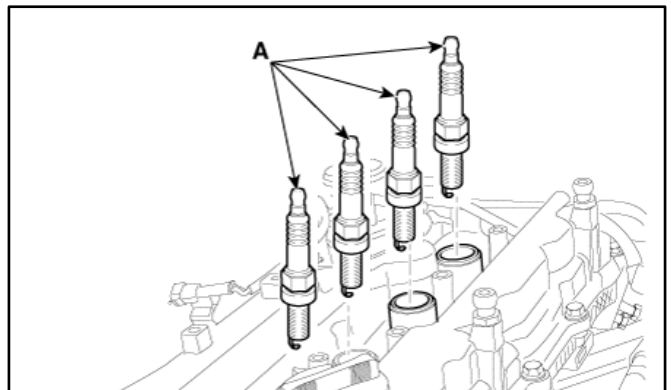

- 3a. Using KDS, connect the VCI-II to the vehicle's OBD-II port.
- 3b. Turn the ignition to 'ON'.
- 3c. On the KDS screen, select '**Special Inspection**' on the bottom tab of the Home screen.
- 3d. Select the applicable vehicle model/year.

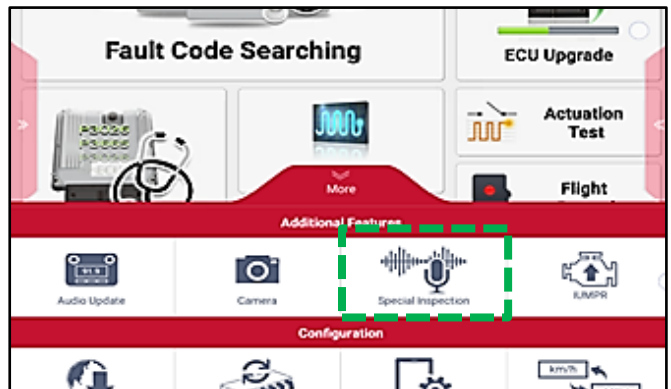

The VIN is recognized automatically and will populate the 'Model' and 'Year'.

- 4a. Enter the vehicle information: the vehicle mileage and RO number.
- 4b. Select 'Verify' to confirm the automatically detected VIN.

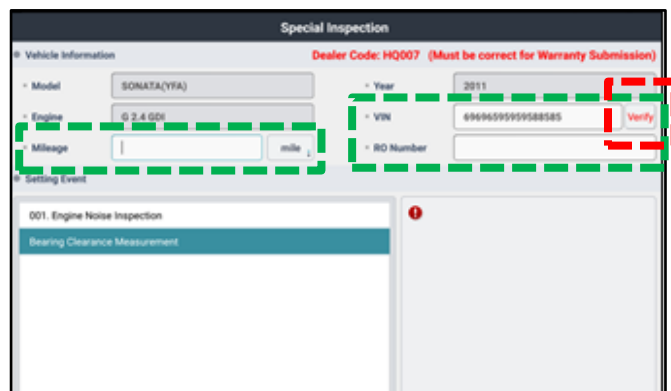

SUBJECT: ENGINE REPLACEMENT INSTRUCTIONS FOR DTC P1326 (PI1803Y/Z)

- 5a. Under “Setting Event”, select **‘Bearing Clearance Measurement’** and then select **‘Next’**.
- 5b. Turn the ignition to ‘OFF’ and remove the VCI-II after verifying the VIN on KDS.

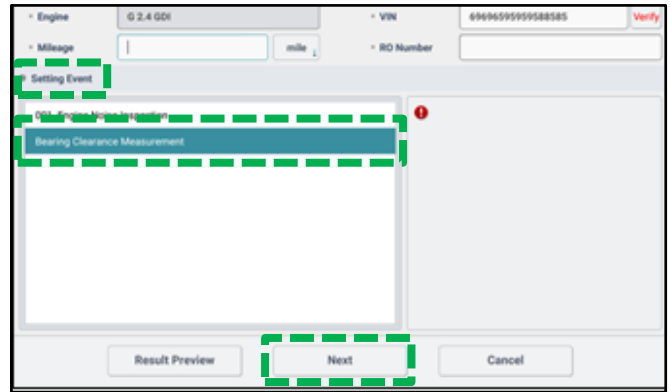

CAUTION
DO NOT attempt to start the engine at any time as damage to the SST and/or engine may occur.

- 6. **STOP** on this screen, proceed to step 7 first before continuing to KDS.

IMPORTANT
DO NOT select ‘Next’ at this time. Proceed to steps 7 – 9 first and continue with KDS as instructed after installing the SST components.



- 7. Install the Dial Gauge fully into the Probe Rod and secure together by hand tightening the locking wingnut.



- 8. **Carefully**, insert the assembled SST Probe Rod and Dial Gauge into the Cylinder 1 spark plug hole and **carefully** turn the SST Crankshaft Rotator **by hand** clockwise until hand tight.

CAUTION
Damage to cylinder head can occur if spark plug hole is cross-threaded. DO NOT use a wrench to tighten the SST rod.



SUBJECT: ENGINE REPLACEMENT INSTRUCTIONS FOR DTC P1326 (PI1803Y/Z)

- Turn the Dial Gauge 'ON' by pressing the 'SET' button.

Reset the Bluetooth connection by pressing both the 'MODE' and 'SET' buttons simultaneously and holding for two (2) seconds.

- Bluetooth icon will blink to indicate pairing mode ✂

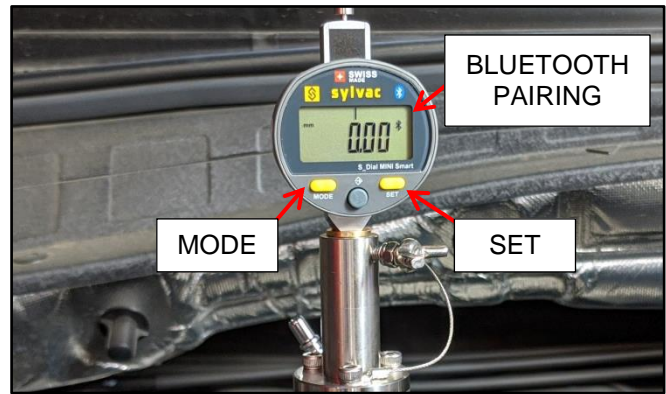

- Using the KDS, select 'Next' on the screen to proceed and begin Top Dead Center (TDC) setup on the KDS.

*** NOTICE**
 Follow the test procedure and sequence as outlined in this bulletin. **DO NOT skip any steps.**

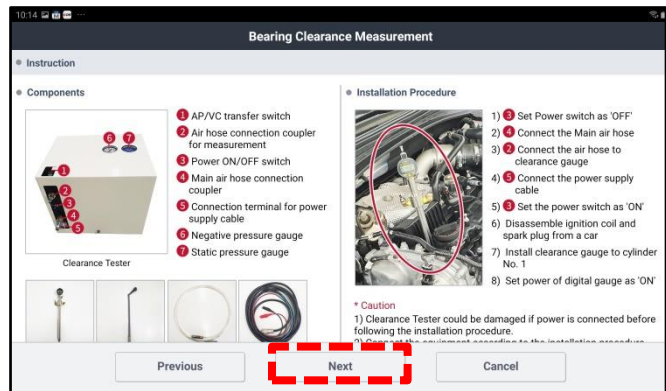

- Pair the Dial Gauge Bluetooth by selecting the device displayed on the screen. Device name is **SY303**.

IMPORTANT
 If the KDS is unable to locate the Dial Indicator Bluetooth device, select 'Previous' and repeat steps 9 - 10. Ensure no other Bluetooth devices are near the KDS and Dial Gauge.

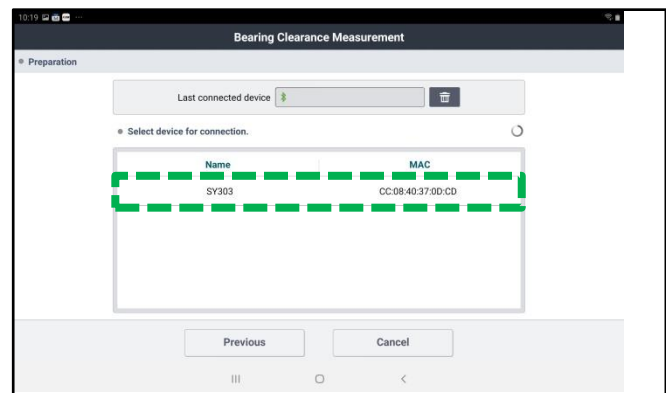

- Once the Dial Gauge is paired to the KDS, the shown screen will appear instructing to insert probe rod into **Cylinder 1**.

*** NOTICE**
 If the probe rod is already inserted into **Cylinder 1** from step 8, disregard this message.

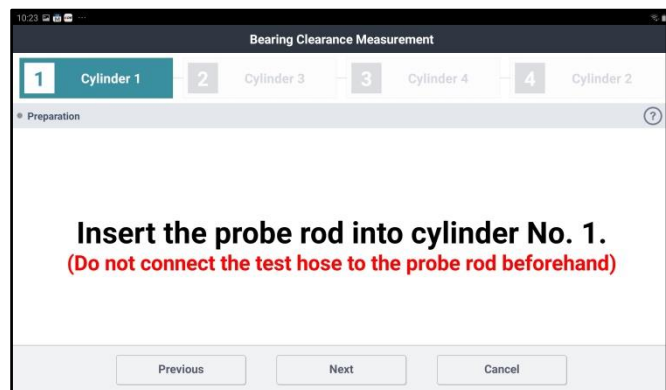

SUBJECT: ENGINE REPLACEMENT INSTRUCTIONS FOR DTC P1326 (PI1803Y/Z)

13. Insert the SST Crankshaft Rotator and turn the crankshaft clockwise as instructed on the KDS screen.

*** NOTICE**

Removal of inner wheel liner and the use of general tools may be required to access and rotate the crank bolt on some 2.0L T-GDI engine models.

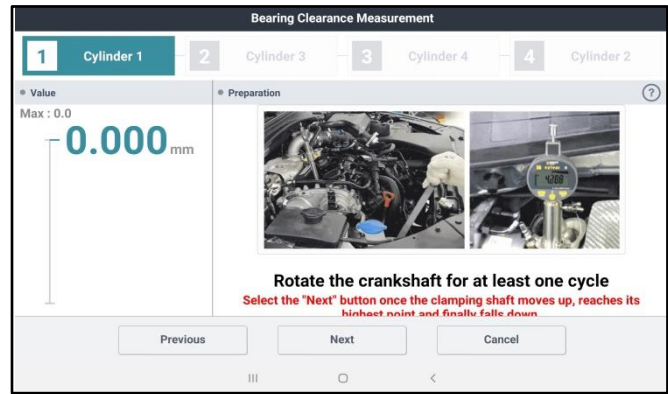

14. Initially, the “Value” ‘Max’ reading may not register when rotating crankshaft. Continue to rotate the crankshaft slowly.

! IMPORTANT

Monitor the displayed reading on the KDS screen/gauge. Turn the crankshaft slowly as the value starts to increase.

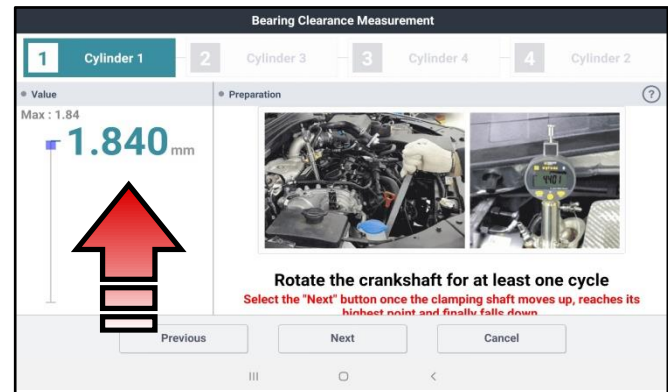

15. Once the ‘Max’ value is reached (sample shows Max: 2.86mm), continue to turn just past the ‘Max’ value reading and STOP rotating the crankshaft (sample shows 2.850mm value decreasing).

Note: The KDS may prompt to rotate the crankshaft ‘counterclockwise’ if needed.

Select ‘Next’.

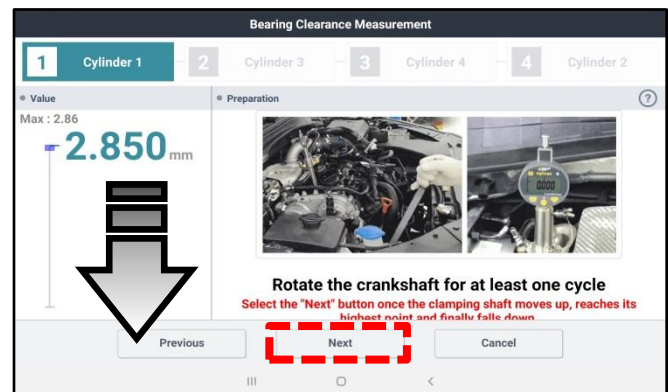

16. If TDC setup is completed successfully:

- **DO NOT** turn the crankshaft rotator.
- **DO NOT** select Start at this time.

STOP on this screen, proceed to step 17 to setup and connect the Engine Bearing Clearance Tester before continuing to the KDS.

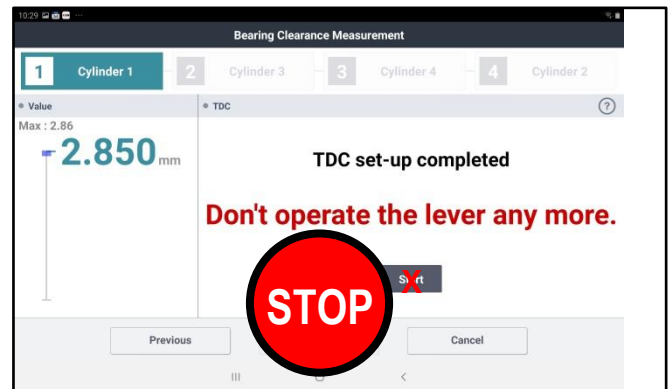

*** NOTICE**

If TDC is NOT found, the KDS may display a message that the cylinder was on the exhaust stroke. If so, repeat steps 13-16.

SUBJECT: ENGINE REPLACEMENT INSTRUCTIONS FOR DTC P1326 (PI1803Y/Z)

17. Prepare to setup the Engine Bearing Clearance Tester and components.

ⓘ IMPORTANT

DO NOT place the SST box over any paper work (ex. RO) as there is a water drain hole located underneath the box. Ensure that the compressed air supply provides consistent adequate air pressure. **DO NOT** use a portable compressor. Always handle the SST box with care, DO NOT hit, drop, and expose to high heat sources or moisture. Do not remove the cover (unless calibration is necessary).

Connect the following three (3) items to the SST Bearing Tester Box:

1. Power Cable (12V)
2. Air Compressor Hose
3. Test Hose

Note: The 12V power cable has red (+) and black (-) connector clamp ends.

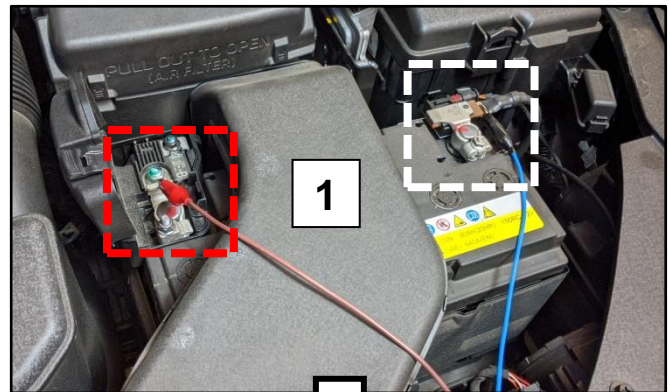

18. Turn the Bearing Clearance Tester power switch to the 'ON' position. Gauges should read as follow:

AP (Pressure) Gauge: (0.1 ~ .011MPa)
VC (Vacuum) Gauge: (-73 ~ -83kPa)

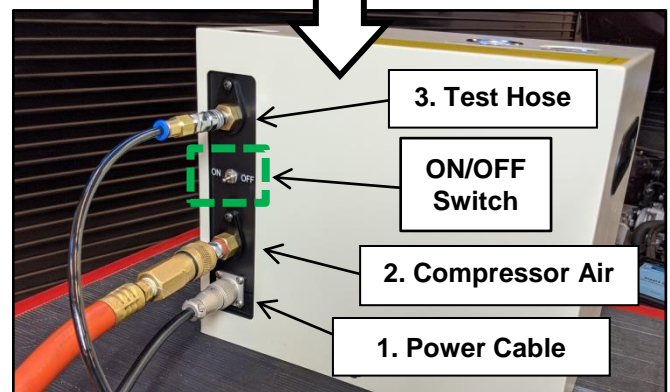
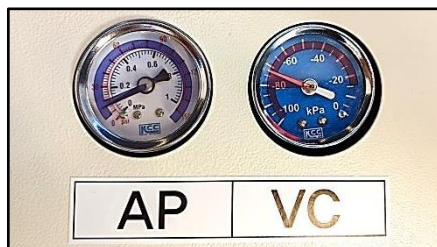

If the gauges do not read within specification, calibration of the SST box is required. Refer to [TSB SST067](#) for details.

19. Carefully, insert and connect the other end of the Test Hose to the Probe Rod fitting.

ⓘ IMPORTANT

DO NOT touch or turn the Crank Rotator in any direction until instructed to do so on the KDS.

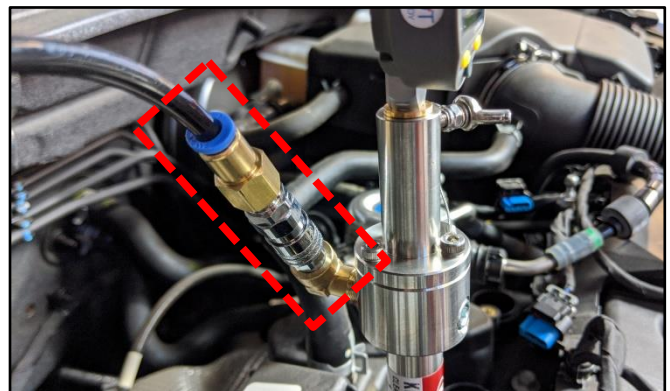

20. Select 'Start'.

*** NOTICE**
 The procedure outlined in this bulletin follows the engine's firing order sequence (1, 3, 4, 2).

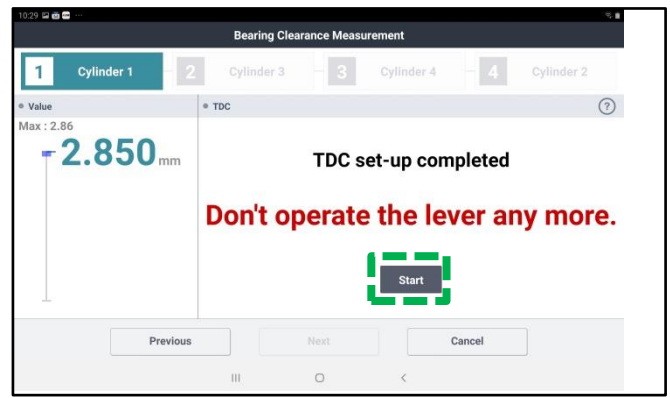
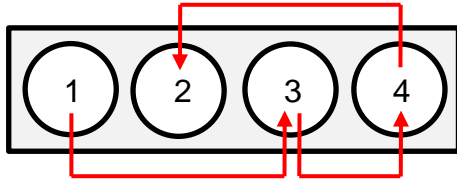

21. Locate the 'AP/VC' switch on top of the Bearing Clearance Tester Box and switch it to the 'AP' position. Select 'Next' to begin **Cylinder 1** bearing clearance test.

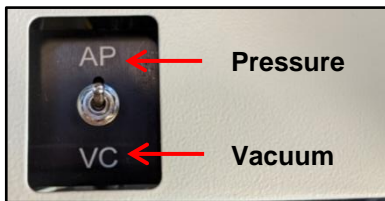

*** NOTICE**
 The toggle switch has a 3-way operation. The center is neutral. Always toggle past neutral.

ⓘ IMPORTANT
 DO NOT touch or turn the Crankshaft Rotator in any direction until instructed to do so via KDS. DO NOT touch the clearance gauge, if touched, an error may occur.

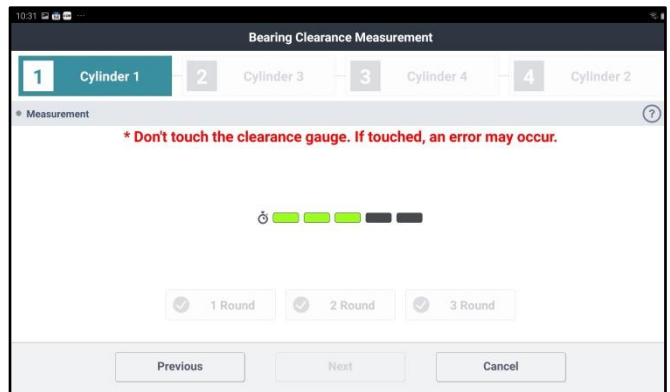
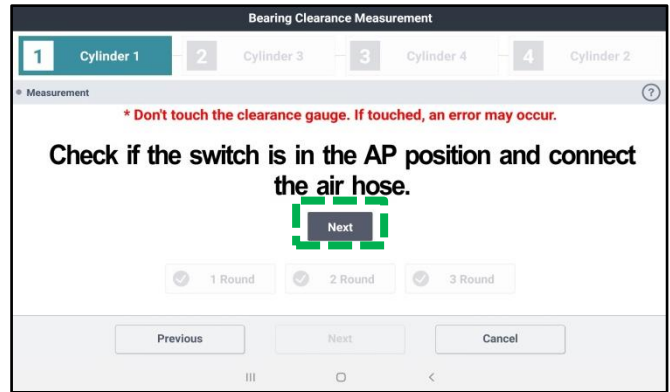

22. The KDS screen will prompt to change the 'AP/VC' switch to the 'VC' position.

Select 'Next' to complete. There are three (3x) rounds per cylinder to complete.

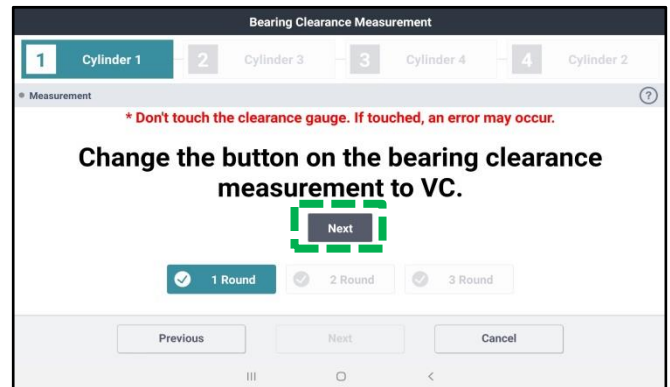

SUBJECT: ENGINE REPLACEMENT INSTRUCTIONS FOR DTC P1326 (PI1803Y/Z)

23. Once Cylinder 1 test is completed, the KDS will prompt to take a picture of the tested cylinder. Select **'Take a picture'**.

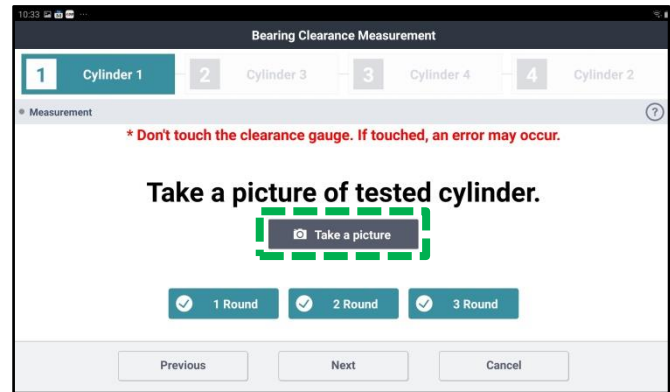

24. Carefully remove the Test Hose and the Probe Rod from Cylinder 1.

The KDS will request to insert the Probe Rod into **Cylinder 3** and prompt to find TDC again. **Repeat steps 13-16.**

Repeat steps 19-23 to test Cylinder 3 and switching from **'AP → VC'** and take cylinder photo.

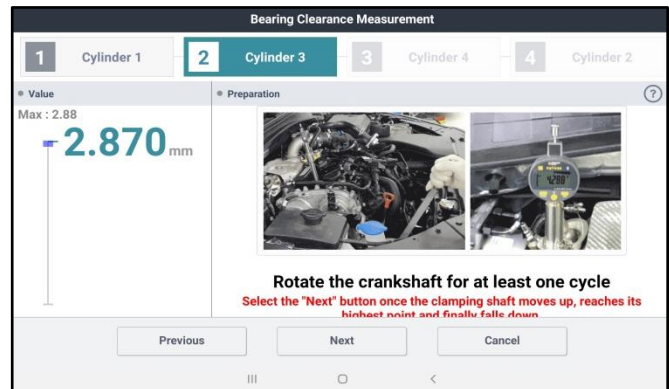

25. Carefully remove the Test Hose and the Probe Rod from Cylinder 3.

The KDS will request to insert the Probe Rod into **Cylinder 4** and prompt to find TDC again. **Repeat steps 13-16.**

Repeat steps 19-23 to test Cylinder 4 and switching from **'AP → VC'** and take cylinder photo.

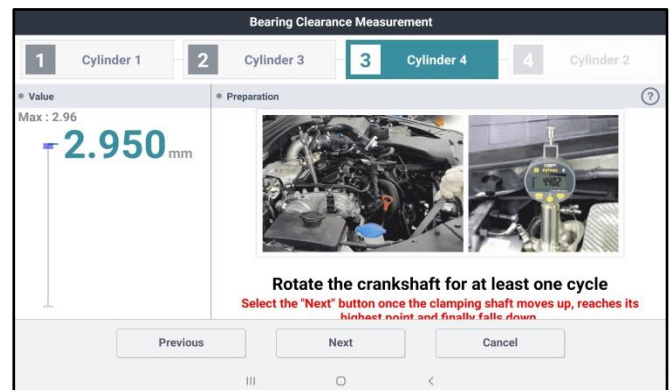

26. Carefully remove the Test Hose and the Probe Rod from Cylinder 4.

The KDS will request to insert the Probe Rod into **Cylinder 2** and prompt to find TDC again. **Repeat steps 13-16.**

Repeat steps 19-23 to test Cylinder 2 and switching from **'AP → VC'** and take cylinder photo.

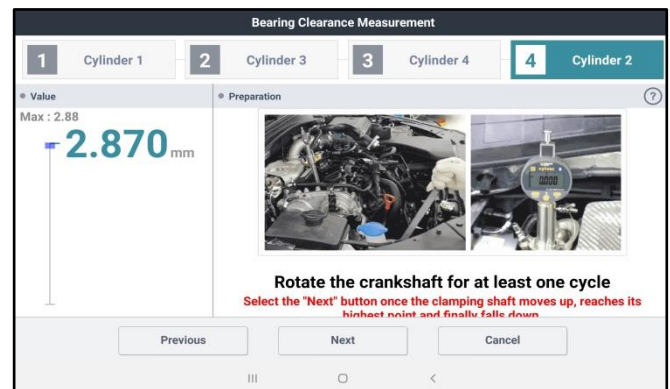

27. After completing the test of all four (4) cylinders, the KDS will prompt to check the crankcase oil level and to select the appropriate check box on the screen.

Select **'Next'**.

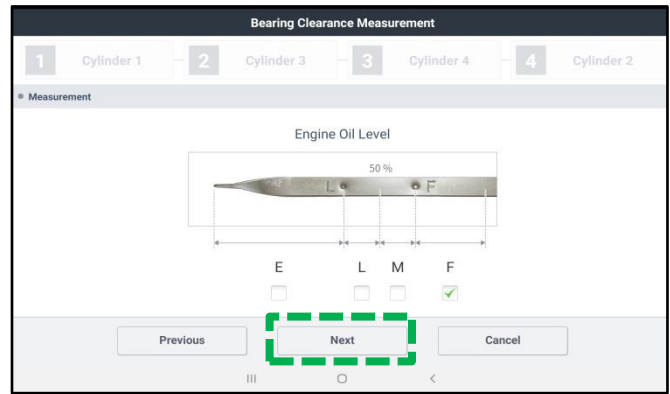

28. If the test result displays **“PASS”**, capture the screen image/screenshot for record keeping.

Select **'Finish'**.

- Re-install all removed parts in the reverse order of removal
- No further action is required

If the test result displays **“NO PASS”**, capture the screen image/screenshot for record keeping. Then proceed to replace the engine assembly per the instructions.

Select **'Finish'**.

- Proceed to **page 11** to replace the engine assembly as outlined in this bulletin

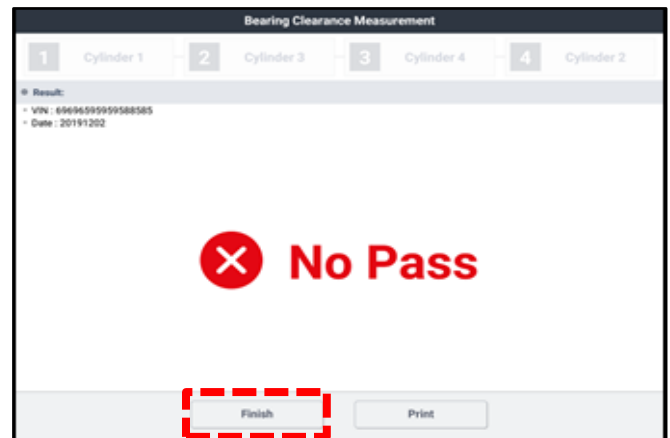
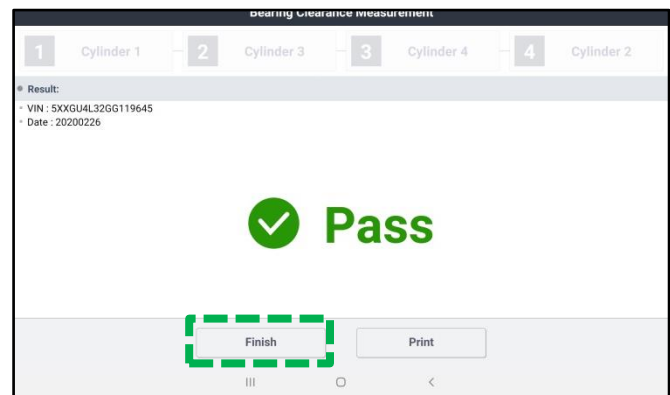

❗ IMPORTANT

Save a copy of the screenshot for your records. It may be required to submit with a PWA. Attach to the RO hard copy.

*** NOTICE**

If the KDS is not connected to the internet, up to five (5) results will stay pending in the queue until the KDS is reconnected with the “Special Inspection” application open, before a sixth (6th) test can be conducted.

SUBJECT: ENGINE REPLACEMENT INSTRUCTIONS FOR DTC P1326 (PI1803Y/Z)
Engine Replacement Procedure:

1. Remove the engine assembly by referring to the “Engine And Transmission (Transaxle) Assembly → Engine And Transmission (Transaxle) Assembly → Repair procedures” chapter in the applicable Shop Manual on KGIS.

Refer to [TSB ENG190](#) for information regarding engine replacement practices.



2. After removal of the engine from the vehicle, remove all components that will need to be transferred by referring to the applicable Shop Manual on KGIS.
3. Place the new engine block on an engine stand.
4. Install all removed components from the old engine block onto the new engine block utilizing all parts from Service Kit I and II. **Be advised of the following notes.**

Tightening torque for Knock Sensor:
13.7 – 17.4 lb.ft (18.6 – 23.5 N.m, 1.9 – 2.4 kgf.m)

Notes:

High Pressure Pump & Roller Tappet:

- Refer to [TSB ENG083](#) for special attention and handling procedures of GDI-specific components.
- When installing the high pressure pump and roller tappet onto the new engine, apply engine oil to the roller tappet, and O-rings of the high pressure pump.

Tightening torques of pump bolts:
9.4 – 10.9 lb.ft (12.8 – 14.7 N.m,
1.3 – 1.5 kgf.m)

Tightening torques of pipe flare nut:
19.5 – 23.9 lb.ft (26.5 – 32.4 N.m,
2.7 – 3.3 kgf.m)

*** NOTICE**

Refer to [TSB ENG083](#) for gasoline direct injection (GDI) specific information, including related warnings and cautions for handling high fuel pressure system components.

High Pressure Fuel Pipe:

1. Properly position the new fuel pipe (A) and then hand-tighten both flare nuts (B).

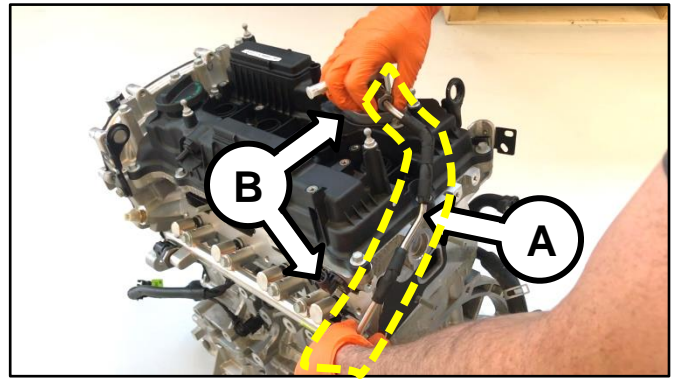

2. Install the pipe retaining bracket and bolt (C) and torque to specifications.

*** NOTICE**

If the bracket and bolt are missing, order and install a new bracket and bolt.

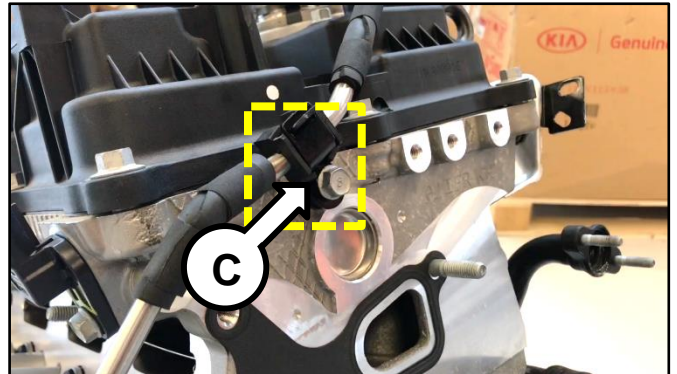

Tightening torque (bracket bolt):
 5.8 – 8.7 lb.ft (7.8 – 11.8 N.m,
 0.8 – 1.2 kgf.m)

3. Using a click-type/electronic torque wrench and SST 09314-3Q100, torque both flare nuts (B) to specifications.

Tightening torque (flare nuts):
 19.5 – 23.9 lb.ft (26.5 – 32.4 N.m,
 2.7 – 3.3 kgf.m)

[Click here to see a video tutorial of high pressure fuel pipe install \(includes high pressure pump install\).](#)

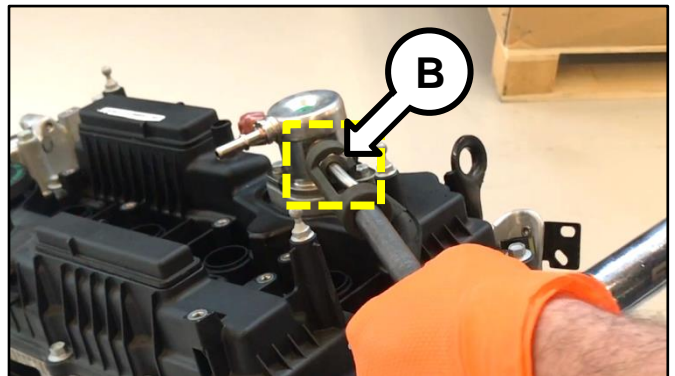
*** IMPORTANT**

The high pressure fuel pipe bracket and bolt must be installed **AND** properly torqued prior to torquing the high pressure fuel pipe flare nuts.

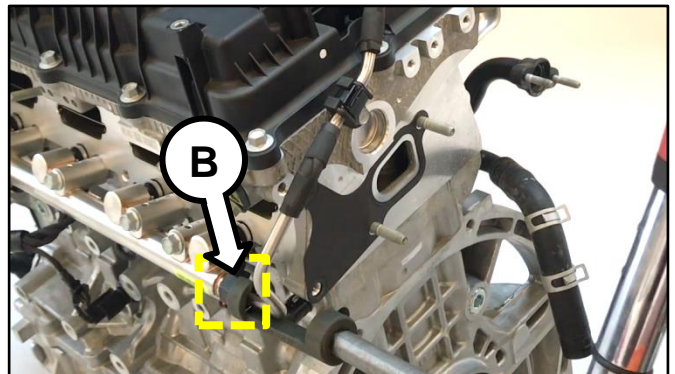

SUBJECT: ENGINE REPLACEMENT INSTRUCTIONS FOR DTC P1326 (PI1803Y/Z)

Delivery Pipe:

- Refer to [TSB ENG083](#) for special attention and handling procedures of GDI-specific components.
- Prior to installing the delivery pipe, be sure to replace all of the injector O-rings and injector retainers.
- Prior to installing the delivery pipe, apply engine oil to the injector O-rings.
- When installing the delivery pipe, use caution not to damage the tip of the injector.
- Be sure to replace the delivery pipe retaining bolts and torque them in the sequence shown.

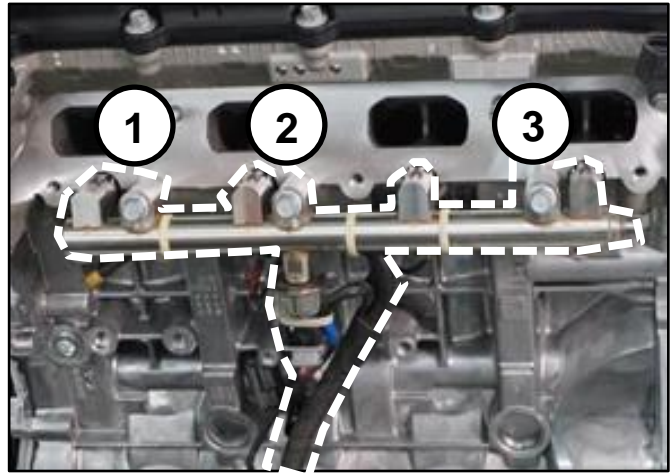
**Tightening torque of bolts:**

**13.7 – 17.4 lb.ft (18.6 – 23.5 N.m,
1.9 – 2.4 kgf.m)**

*** NOTICE**

Combustion seals must be compressed after installation and before attempting to install into the cylinder head. Use SST 09353 2B000 (refer to [TSB ENG083](#)).

Dipstick Tube & Dipstick:

- Prior to installing the new tube, lubricate the o-ring located at the bottom of the tube with engine oil.
- Install the red dipstick included in Service Kit I.

Tightening torque of bolt:

**5.8 – 8.7 lb.ft (7.8 – 11.8 N.m,
0.8 - 1.2 kgf.m)**

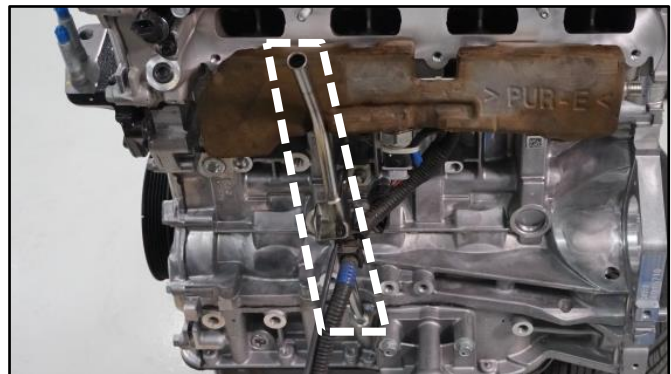

Intake Manifold:

- Prior to installation, replace the intake manifold gaskets.
- Torque bolts in the sequence shown.

Tightening torque of bolts:

**13.7 – 17.4 lb.ft (18.6 – 23.5 N.m,
1.9 – 2.4 kgf.m)**

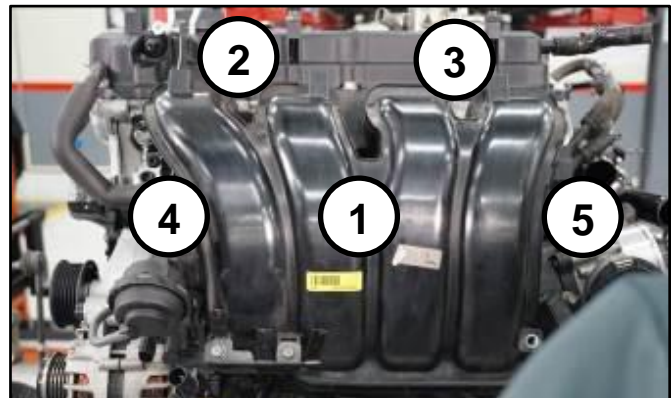

Exhaust Manifold:

- All engines supplied under this Product Improvement Campaign have the exhaust manifold studs configured for SULEV engines.
- Using the pictures to the right, check the exhaust manifold stud location and quantity. Relocate as required for ULEV engines and obtain one (1) extra from the removed engine.
- Prior to installation, replace the exhaust manifold gasket and front muffler gasket.
- Torque nuts in the sequence shown.

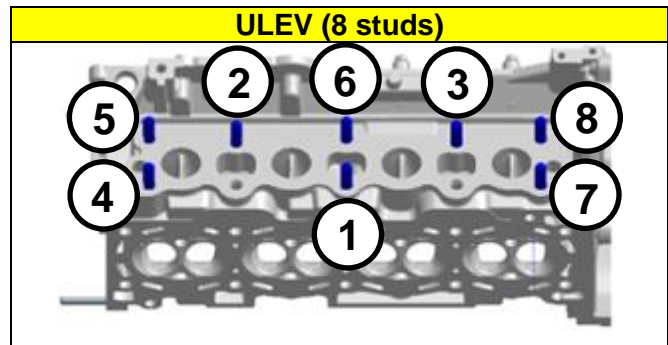
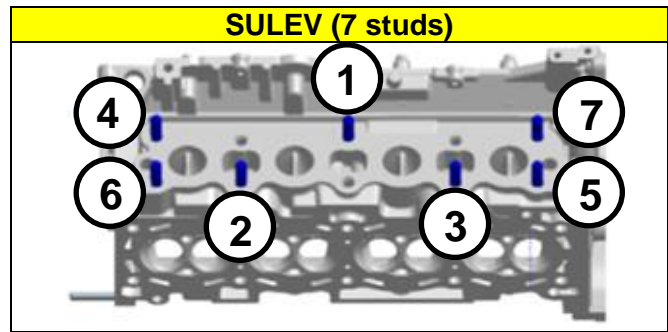

Tightening torque of nuts:
 36.2 – 39.7 lb.ft (49.0 – 53.9 N.m,
 5.0 – 5.5 kgf.m)

***For 15MY Sorento (XMa) vehicles only:** check the underhood emissions label and record whether the label references ULEV or SULEV. This information is needed to select/order the correct replacement engine.

KIA		KIA MOTORS CORPORATION	
VEHICLE EMISSION CONTROL INFORMATION			
Conforms to regulations :		2015 MY	
U.S.EPA : T2B5 LDV	OBD : CA II	Fuel : Gasoline	
California : ULEV	PC	OBD : CA II	Fuel : Gasoline
Group : EKX6V2Z4APE	DFI/HO2S(2)/WU-TWC/TWC		
Evap. : EKX6V2Z4APE	No adjustments needed.		A402
[WARNING]			
Loaded I/M testing of permanent four-wheel drive or traction control-equipped vehicles must be conducted on a four-wheel drive speed synchronized dynamometer. Otherwise, a non-loaded test procedure must be performed.			

- On Turbo engines, replace the turbocharger oil feed line and gaskets.

Tightening torque of oil feed line bolt:
 8.7 – 13.0 lb.ft (11.8 – 17.7 N.m,
 1.2 – 1.8 kgf.m)

Tightening torque of oil feed line nuts:
 5.8 – 8.7 lb.ft (7.8 – 11.8 N.m,
 0.8 – 1.2 kgf.m)

Tightening torque of oil drain line nuts and bolts:
 5.8 – 8.7 lb.ft (7.8 – 11.8 N.m,
 0.8 – 1.2 kgf.m)

- Torque exhaust manifold nuts in the sequence shown.

Tightening torque of nuts:
 36.2 – 39.7 lb.ft (49.0 – 53.9 N.m,
 5.0 – 5.5 kgf.m)

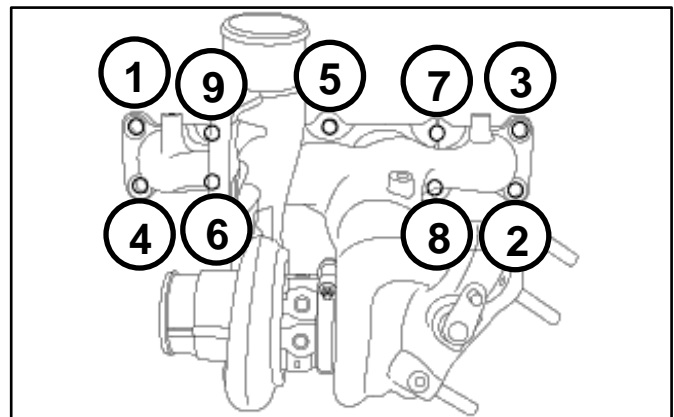

SUBJECT: ENGINE REPLACEMENT INSTRUCTIONS FOR DTC P1326 (PI1803Y/Z)
Oil Cooler Tube Assembly:

New engines may be supplied with a different oil cooler. Use steps below to determine the need for a replacement oil cooler tube assembly.

- If the new engine's (bigger) oil cooler (A) does not match the old engine's (smaller) oil cooler (B), replace the oil cooler tube assembly with the improved part. See parts table on page 24.
- If the new engine's (bigger) oil cooler (A) matches the old engine's (bigger) oil cooler (A), reuse the old engine's oil cooler tube assembly.
- If the new engine's (smaller) oil cooler (B) matches the old engine's (smaller) oil cooler (B), reuse the old engine's oil cooler tube assembly.

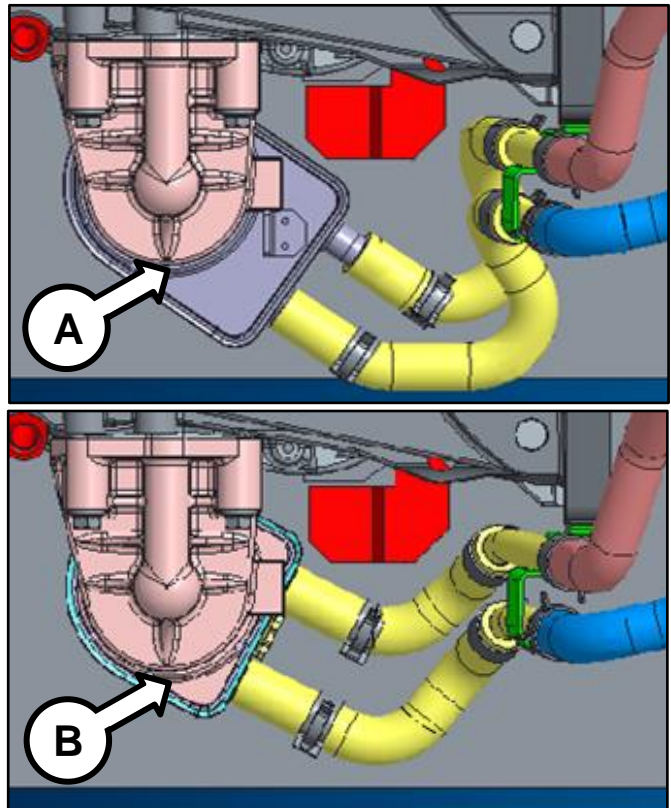
Drive Plate Bolts:

- Replace all seven (7) drive plate (AT) bolts.

Tightening torque of nuts:

**86.8 – 93.9 lb.ft (117.7 – 125.5 N.m,
12.0 – 13.0 kgf.m)**

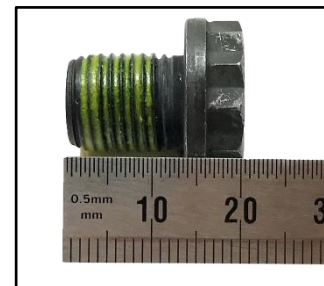

Drive Plate Bolt (A/T)

Torque Converter

- If the torque converter has moved from the fully inserted position, carefully push inward while rotating the torque converter until it is recessed approximately 9/16 – 5/8" (14 – 16mm) (☑) into the transaxle case when reinstalling the automatic transaxle.

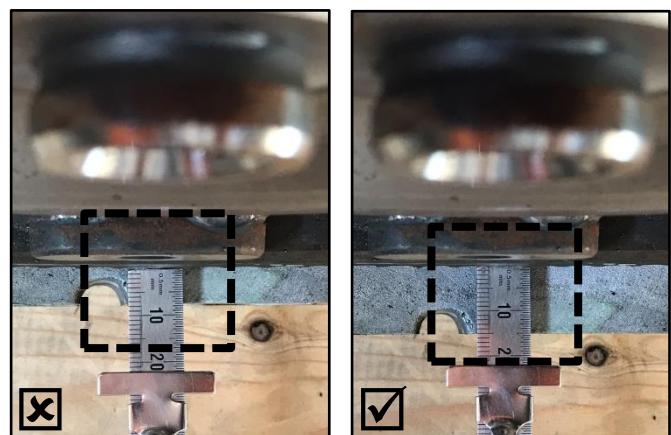

Not Fully Inserted

Fully Inserted

5. Reinstall the assembled engine and transmission/transaxle into the vehicle.

Be sure to:

- Fill crankcase with 5W-30 oil (~5.8 quarts).
- Recommended Product: QUARTZ 9000 FUTURE FGC 5W-30 Full Synthetic SN PLUS, QUARTZ 9000 FUTURE XT 5W30 Full Synthetic SN PLUS, Mobil Super Synthetic 5W30 or above.
If not available, use other brand 5W30 and Full synthetic type with API SN/SN+/SP, ILSAC GF4/GF5 or higher service grade.
- Fill and bleed the cooling system with 50/50 coolant or mixture appropriate for area.
- Pressurize the fuel system before starting the vehicle.
- Reset engine adaptive values and perform steering angle sensor calibration.

Refer to [TSB ENG190](#) for information regarding engine replacement practices.

6. Confirm that the Rom ID is up-to-date. If not, reflash the ECU to the latest ROM ID available. Refer to PI1803 – Knock Sensor Detection System ECU Logic Improvement



7. Verify proper operation of the vehicle with road test, and **with the engine ON (running)**, **erase any stored DTCs** (e.g., EPS, ESC, and TPMS) that may have been set by this procedure. Verify no leaks exist and ensure engine oil and coolant are at their proper level.

If any DTCs are still active, follow any related diagnosis and repair as needed.

SUBJECT: ENGINE REPLACEMENT INSTRUCTIONS FOR DTC P1326 (P11803Y/Z)
AFFECTED VEHICLE RANGE:

Model	Production Date Range
11-13MY Optima (QF/TF)	August 12, 2010 through September 27, 2013
14MY Optima (QF)	August 28, 2013 through May 15, 2014
12-14MY Sorento (XMa)	April 19, 2011 through February 10, 2014
11-13MY Sportage (SL)	December 30, 2010 through August 30, 2013

REQUIRED TOOL:









Tool Name	Tool Part No.	Figure	Comments
Torque Wrench Socket	09314 3Q100		Refer to TSB ENG083 for detailed usage instructions
Injector Combustion Seal Ring Installer	09353 2B000		
Click-Type or Electronic Torque Wrench	N/A		Locally Sourced
Bearing Clearance Tester Kit	KQ231 2T110QQK		<p>Auto-shipped to Dealers For troubleshooting assistance contact the GITA Support Line at: (888) 542-4371.</p> <p>For replacement parts, contact Snap-On Tools at: (888) 542-1011.</p>

REQUIRED PARTS:

Part Name	MY	Model	Part Number		Figure
			2.4L GDI	2.0L T-GDI	
Engine Long Block	11-13MY	TF, QF	21101 2GK05QQKR	21101 2GK07QQKR	
		SL	-		
	12-13MY	XMa	21101 2GK09QQKR	-	
	14MY	XMa (ULEV/SULEV)	21101 2GK11QQKR	-	
	14MY	QF	21101 2GK06QQKR	21101 2GK08QQKR	

Continued on page 18.

SUBJECT: ENGINE REPLACEMENT INSTRUCTIONS FOR DTC P1326 (PI1803Y/Z)

Models	Part Name	Engine	Part Number	Figure	
TF, SL, QF, XMa	Service Kit I	2.4L GDI	21111 2GK50QQK		
		2.0L T-GDI	21111 2GK60QQK		
UMa, QL, JF, JFa		2.4L GDI	21111 2GK51QQK		
		2.0L T-GDI	21111 2GK52QQK		
TF, SL, QF, XMa		Service Kit II	2.4L GDI and 2.0L T-GDI	21111 2GK70QQK	
UMa, QL, JF, JFa			2.4L GDI	21111 2GK71QQK	
			2.0L T-GDI	21111 2GK72QQK	
All		Drive Plate Bolts	2.4L GDI and 2.0L T-GDI	23311 25050	
	Oil Cooler Tube Assembly (replacement is conditional, refer to page 15)	2.4L GDI	25470 2G050QQK		
		2.0L T-GDI	25470 2G650QQK		

***Oil Cooler Tube assembly replacement is conditional, refer to page 15.**

ⓘ IMPORTANT

WARRANTY Y1 and Z1 CLAIM INFORMATION:

PI1803Y1: MIL ON WITH P1326, BEARING CLEARANCE TEST PASS OR NO PASS.

PI1803Z1: PWA ACQUIRED, ENGINE NOISE/SEIZED, BEARING CLEARANCE TEST OR NO TEST.

SUBJECT: ENGINE REPLACEMENT INSTRUCTIONS FOR DTC P1326 (PI1803Y/Z)

WARRANTY INFORMATION (PI1803Y1)

N Code: I12 C Code: ZZ5

Model	Claim Type	Causal P/N	Qty.	Repair Description	Labor Op Code	Op Time	Replacement P/N	Qty.
QF (2.4L) FWD	R	23060 2G400		Bearing Clearance Test <u>PASS</u> +S/W Inspection	180A23A4	0.6 M/H	N/A	0
				Bearing Clearance Test <u>PASS</u> +S/W Inspection and Update	180A23A5	0.7 M/H	N/A	0
				Bearing Clearance Test <u>NO PASS</u> Engine Replaced +S/W Inspection	180A23A2	8.7 M/H	(2011-2013MY) 21101 2GK05QQKR (2014MY) 21101 2GK06QQKR 21111 2GK50QQK 21111 2GK70QQK	1
				Bearing Clearance Test <u>NO PASS</u> Engine Replaced +S/W Inspection and Update	180A23A3	8.8 M/H	23311 25050 (AT) Qty.7 23231 25200 (MT) Qty.7 25470 2G050QQK*	
QF (2.0L-T) FWD	R	23060 2G400	0	Bearing Clearance Test <u>PASS</u> +S/W Inspection	180A23AA	0.6 M/H	N/A	0
				Bearing Clearance Test <u>PASS</u> +S/W Inspection and Update	180A23AB	0.7 M/H	N/A	0
				Bearing Clearance Test <u>NO PASS</u> Engine Replaced +S/W Inspection	180A23A8	8.9 M/H	(2011-2013MY) 21101 2GK07QQKR (2014MY) 21101 2GK08QQKR 21111 2GK60QQK 21111 2GK70QQK	1
				Bearing Clearance Test <u>NO PASS</u> Engine Replaced +S/W Inspection and Update	180A23A9	9.0 M/H	23311 25050 (Qty. 7) 25470 2G650QQK*	
SL (2.0L-T) FWD	R	23060 2G400	0	Bearing Clearance Test <u>PASS</u> +S/W Inspection	180143A4	0.9 M/H	N/A	0
				Bearing Clearance Test <u>PASS</u> +S/W Inspection and Update	180143A5	1.0 M/H	N/A	0
				Bearing Clearance Test <u>NO PASS</u> Engine Replaced +S/W Inspection	180143A2	8.1 M/H	21101 2GK07QQKR 21111 2GK60QQK 21111 2GK70QQK 23311 25050 (Qty. 7) 25470 2G650QQK*	1
				Bearing Clearance Test <u>NO PASS</u> Engine Replaced +S/W Inspection and Update	180143A3	8.2 M/H		



SUBJECT: ENGINE REPLACEMENT INSTRUCTIONS FOR DTC P1326 (P11803Y/Z)

Model	Claim Type	Causal P/N	Qty.	Repair Description	Labor Op Code	Op Time	Replacement P/N	Qty.
SL (2.0L-T) AWD	R	23060 2G400	0	Bearing Clearance Test <u>PASS</u> +S/W Inspection	180143AA	0.9 M/H	N/A	0
				Bearing Clearance Test <u>PASS</u> +S/W Inspection and Update	180143AB	1.0 M/H	N/A	0
				Bearing Clearance Test <u>NO PASS</u> Engine Replaced +S/W Inspection	180143A8	8.5 M/H	21101 2GK07QQKR 21111 2GK60QQK 21111 2GK70QQK 23311 25050 (Qty. 7) 25470 2G650QQK*	1
				Bearing Clearance Test <u>NO PASS</u> Engine Replaced +S/W Inspection and Update	180143A9	8.6 M/H		
TF (2.0L-T) FWD	R	23060 2G400	0	Bearing Clearance Test <u>PASS</u> +S/W Inspection	180142AA	0.7 M/H	N/A	0
				Bearing Clearance Test <u>PASS</u> +S/W Inspection and Update	180142AB	0.8 M/H	N/A	0
				Bearing Clearance Test <u>NO PASS</u> Engine Replaced +S/W Inspection	180142A8	8.7 M/H	21101 2GK07QQKR 21111 2GK60QQK 21111 2GK70QQK 23311 25050 (Qty. 7) 25470 2G650QQK*	1
				Bearing Clearance Test <u>NO PASS</u> Engine Replaced +S/W Inspection and Update	180142A9	8.8 M/H		
TF (2.4L) FWD	R	23060 2G400	0	Bearing Clearance Test <u>PASS</u> +S/W Inspection	180142A4	0.7 M/H	N/A	0
				Bearing Clearance Test <u>PASS</u> +S/W Inspection and Update	180142A5	0.8 M/H	N/A	0
				Bearing Clearance Test <u>NO PASS</u> Engine Replaced +S/W Inspection	180142A2	8.7 M/H	(2011-2013MY) 21101 2GK05QQKR (2014MY) 21101 2GK06QQKR 21111 2GK50QQK 21111 2GK70QQK 23311 25050 (AT) Qty.7 23231 25200 (MT) Qty.7 25470 2G050QQK*	1
				Bearing Clearance Test <u>NO PASS</u> Engine Replaced +S/W Inspection and Update	180142A3	8.8 M/H		

SUBJECT: ENGINE REPLACEMENT INSTRUCTIONS FOR DTC P1326 (P11803Y/Z)

Model	Claim Type	Causal P/N	Qty.	Repair Description	Labor Op Code	Op Time	Replacement P/N	Qty.
XMa (2.4L) FWD	R	21020 2G010	0	Bearing Clearance Test <u>PASS</u> +S/W Inspection	180A24A4	0.6 M/H	N/A	0
				Bearing Clearance Test <u>PASS</u> +S/W Inspection and Update	180A24A5	0.7 M/H	N/A	0
				Bearing Clearance Test <u>NO PASS</u> Engine Replaced +S/W Inspection	180A24A2	8.7 M/H	(2012-2013MY) 21101 2GK09QQKR (14MY ULEV/SULEV) 21101 2GK11QQKR 21111 2GK50QQK 21111 2GK70QQK 23311 25050 (Qty. 7) 25470 2G050QQK*	1
				Bearing Clearance Test <u>NO PASS</u> Engine Replaced +S/W Inspection and Update	180A24A3	8.8 M/H		
XMa (2.4L) AWD	R	21020 2G010	0	Bearing Clearance Test <u>PASS</u> +S/W Inspection	180A24AA	0.6 M/H	N/A	0
				Bearing Clearance Test <u>PASS</u> +S/W Inspection and Update	180A24AB	0.7 M/H	N/A	0
				Bearing Clearance Test <u>NO PASS</u> Engine Replaced +S/W Inspection	180A24A8	8.9 M/H	(2012-2013MY) 21101 2GK09QQKR (14MY ULEV/SULEV) 21101 2GK11QQKR 21111 2GK50QQK 21111 2GK70QQK 23311 25050 (Qty. 7) 25470 2G050QQK*	1
				Bearing Clearance Test <u>NO PASS</u> Engine Replaced +S/W Inspection and Update	180A24A9	9.0 M/H		

***Oil Cooler Tube assembly replacement is conditional, refer to page 15.**

NOTE: Refer to Warranty Bulletin 2020-06 for details regarding coolant and substitute transportation reimbursement requirements.

Use sublet code 'X3' with a maximum allowed amount of \$19.80 for "**ENGINE R&R**" engine oil reimbursement.

If the replacement of the Oil Cooler Tube Assembly was required, please manually enter the applicable Oil Cooler Tube Assembly part number to the claim's related parts section.

Dispose of old parts in accordance with local, state, and Federal regulations.



SUBJECT: ENGINE REPLACEMENT INSTRUCTIONS FOR DTC P1326 (PI1803Y/Z)

WARRANTY INFORMATION (PI1803Z1)

N Code: I12 C Code: ZZ5

Model	Claim Type	Causal P/N	Qty.	Repair Description	Labor Op Code	Op Time	Replacement P/N	Qty.
QF (2.0L-T) FWD	R	23060 2G400	0	PWA - Engine Replaced +S/W Inspection	180A23A6	8.4	(2011-2013MY) 21101 2GK07QQKR (2014MY) 21101 2GK08QQKR 21111 2GK60QQK 21111 2GK70QQK 23311 25050 (Qty. 7) 25470 2G650QQK*	1
				PWA - Engine Replaced +S/W Inspection and Update	180A23A7	8.5		
				Bearing Clearance Test PWA - Engine Replaced +S/W Inspection	180A23B7	8.9		
				Bearing Clearance Test PWA - Engine Replaced +S/W Inspection and Update	180A23B8	9		
QF (2.4L) FWD	R	23060 2G400	0	PWA - Engine Replaced +S/W Inspection	180A23A0	8.2	(2011-2013MY) 21101 2GK05QQKR (2014MY) 21101 2GK06QQKR 21111 2GK50QQK 21111 2GK70QQK 23311 25050 (AT) Qty.7 23231 25200 (MT) Qty.7 25470 2G050QQK*	1
				PWA - Engine Replaced +S/W Inspection and Update	180A23A1	8.3		
				Bearing Clearance Test PWA - Engine Replaced +S/W Inspection	180A23B3	8.7		
				Bearing Clearance Test PWA - Engine Replaced +S/W Inspection and Update	180A23B4	8.8		
SL (2.0L-T) FWD	R	23060 2G400	0	PWA - Engine Replaced +S/W Inspection	18014 3A0	7.4	21101 2GK07QQKR 21111 2GK60QQK 21111 2GK70QQK 23311 25050 (Qty. 7) 25470 2G650QQK*	1
				PWA - Engine Replaced +S/W Inspection and Update	18014 3A1	7.5		
				Bearing Clearance Test PWA - Engine Replaced +S/W Inspection	18014 3B3	8.1		
				Bearing Clearance Test PWA - Engine Replaced +S/W Inspection and Update	18014 3B4	8.2		



SUBJECT: ENGINE REPLACEMENT INSTRUCTIONS FOR DTC P1326 (P11803Y/Z)

Model	Claim Type	Causal P/N	Qty.	Repair Description	Labor Op Code	Op Time	Replacement P/N	Qty.
SL (2.0L-T) AWD	R	23060 2G400	0	PWA - Engine Replaced +S/W Inspection	180143A6	7.8	21101 2GK07QQKR 21111 2GK60QQK 21111 2GK70QQK 23311 25050 (Qty. 7) 25470 2G650QQK*	1
				PWA - Engine Replaced +S/W Inspection and Update	180143A7	7.9		
				Bearing Clearance Test PWA - Engine Replaced +S/W Inspection	180143B7	8.5		
				Bearing Clearance Test PWA - Engine Replaced +S/W Inspection and Update	180143B8	8.6		
TF (2.0L-T) FWD	R	23060 2G400	0	PWA - Engine Replaced +S/W Inspection	180142A6	8.2	21101 2GK07QQKR 21111 2GK50QQK 21111 2GK70QQK 23311 25050 (AT) Qty.7 23231 25200 (MT) Qty.7 25470 2G050QQK*	1
				PWA - Engine Replaced +S/W Inspection and Update	180142A7	8.3		
				Bearing Clearance Test PWA - Engine Replaced +S/W Inspection	180142B7	8.7		
				Bearing Clearance Test PWA - Engine Replaced +S/W Inspection and Update	180142B8	8.8		
TF (2.4L) FWD	R	23060 2G40	0	PWA - Engine Replaced +S/W Inspection	180142A0	8.2	(2011-2013MY) 21101 2GK05QQKR (2014MY) 21101 2GK06QQKR 21111 2GK50QQK 21111 2GK70QQK 23311 25050 (AT) Qty.7 23231 25200 (MT) Qty.7 25470 2G050QQK*	1
				PWA - Engine Replaced +S/W Inspection and Update	180142A1	8.3		
				Bearing Clearance Test PWA - Engine Replaced +S/W Inspection	180142B3	8.7		
				Bearing Clearance Test PWA - Engine Replaced +S/W Inspection and Update	180142B4	8.8		



SUBJECT: ENGINE REPLACEMENT INSTRUCTIONS FOR DTC P1326 (PI1803Y/Z)

Model	Claim Type	Causal P/N	Qty.	Repair Description	Labor Op Code	Op Time	Replacement P/N	Qty.		
XMa (2.4L) FWD	R	21020 2G010	0	PWA - Engine Replaced +S/W Inspection	180A24A0	8.2	(2012-2013MY) 21101 2GK09QQKR (14MY ULEV/SULEV) 21101 2GK11QQKR 21111 2GK50QQK 21111 2GK70QQK 23311 25050 (Qty. 7) 25470 2G050QQK*	1		
				PWA - Engine Replaced +S/W Inspection and Update	180A24A1	8.3				
				Bearing Clearance Test PWA - Engine Replaced +S/W Inspection	180A24B3	8.7				
				Bearing Clearance Test PWA - Engine Replaced +S/W Inspection and Update	180A24B4	8.8				
XMa (2.4L) AWD	R		21020 2G010	0	PWA - Engine Replaced +S/W Inspection	180A24A6		8.4	(2012-2013MY) 21101 2GK09QQKR (14MY ULEV/SULEV) 21101 2GK11QQKR 21111 2GK50QQK 21111 2GK70QQK 23311 25050 (Qty. 7) 25470 2G050QQK*	1
					PWA - Engine Replaced +S/W Inspection and Update	180A24A7		8.5		
					Bearing Clearance Test PWA - Engine Replaced +S/W Inspection	180A24B7		8.9		
					Bearing Clearance Test PWA - Engine Replaced +S/W Inspection and Update	180A24B8		9		

***Oil Cooler Tube assembly replacement is conditional, refer to page 15.**

NOTE: Refer to Warranty Bulletin 2020-05 for details regarding coolant and substitute transportation reimbursement requirements.

Use sublet code 'X3' with a maximum allowed amount of \$19.80 for "**ENGINE R&R**" engine oil reimbursement.

If the replacement of the Oil Cooler Tube Assembly was required, please manually enter the applicable Oil Cooler Tube Assembly part number to the claim's related parts section.

Dispose of old parts in accordance with local, state, and Federal regulations.

*** NOTICE**

VIN inquiry data for this repair is provided for tracking purposes only. Kia retailers should reference PI1803Y/Z* when accessing the WebDCS system.

