



<b>Subject:</b> 2020 CX-30 SERVICE CAUTIONS FOR NEW AND REVISED FEATURES	<b>Service Alert No.:</b> SA-051/19
	<b>Last Issued:</b> 12/18/2019

## BULLETIN NOTES

This bulletin supersedes the previously issued bulletin(s) listed below. The changes are noted in Red text.

Previous Service Alerts:	Date(s) Issued:
SA-051/19	12/03/2019 and 12/13/2019

## APPLICABLE MODEL(S)/VINS

2020 CX-30

## DESCRIPTION

The 2020 CX-30 has new and revised features that are different from previous models, and may be difficult to understand. This Service Alert provides valuable information to support potential dealer and customer concerns.

## Index

- PDI fuse
- Auxiliary Key
- Connected Vehicle
- Connected Vehicle Maintenance Mode
- Mazda Connected Vehicle Viewer (MCSV)
- Off-Road Traction Assist
- Apple CarPlay™ / Android Auto™ Install Kit
- Blind Spot Monitoring System (BSM)
- Front Wiper Service Caution
- i-ACTIVSENSE Switch
- Traffic Sign Recognition (TSR)

**CONSUMER NOTICE:** The information and instructions in this bulletin are intended for use by skilled technicians. Mazda technicians utilize the proper tools/equipment and take training to correctly and safely maintain Mazda vehicles. These instructions should not be performed by "do-it-yourselfers." Customers should not assume this bulletin applies to their vehicle or that their vehicle will develop the described concern. To determine if the information applies, customers should contact their nearest authorized Mazda dealership. Mazda North American Operations reserves the right to alter the specifications and contents of this bulletin without obligation or advance notice. All rights reserved. No part of this bulletin may be reproduced in any form or by any means, electronic or mechanical---including photocopying and recording and the use of any kind of information storage and retrieval system ---without permission in writing.

MAZDA CONNECT Power Function  
MAZDA CONNECT Center Display View  
In-Vehicle Digital Owner's Manual  
Navigation System  
SIRIUSXM Data Service  
Power Door Locks  
Transmitter Battery Saving Function  
Keyless Entry Using Auxiliary Key  
Rear Door Child Safety Locks Operation  
Theft-Deterrent System  
Link Seat & Climate Control Temperatures  
Seat Warmer Inoperative  
Electric Parking Brake (EPB)  
Tire Pressure Monitoring System (TPMS)  
Condition Based Maintenance  
M-MDS (MDARS)  
Part Replacement  
Web-Based Training Courses

Item	Service Information
------	---------------------

**CONSUMER NOTICE:** The information and instructions in this bulletin are intended for use by skilled technicians. Mazda technicians utilize the proper tools/equipment and take training to correctly and safely maintain Mazda vehicles. These instructions should not be performed by "do-it-yourselfers." Customers should not assume this bulletin applies to their vehicle or that their vehicle will develop the described concern. To determine if the information applies, customers should contact their nearest authorized Mazda dealership. Mazda North American Operations reserves the right to alter the specifications and contents of this bulletin without obligation or advance notice. All rights reserved. No part of this bulletin may be reproduced in any form or by any means, electronic or mechanical---including photocopying and recording and the use of any kind of information storage and retrieval system ---without permission in writing.

Fuse to be Installed at PDI

There are 2 fuses removed at the factory that should be installed at PDI.

- 1. Fuse F27 (25A) - Fuse Block Engine Compartment
- 2. One of the following:
  - 1. Fuse F7 (25A) - Equipped with Power Liftgate - Fuse Block Left Side
  - 2. Fuse F15 (15A) - Not equipped with Power Liftgate - Fuse Block Left Side

**Note:** Check for Connected Vehicle signal after installing room fuses. See the image below for how the connectivity signal bar looks (it's the vertical stack bar on the right bottom corner). This connectivity signal bar is not displayed on the "Home" screen. Go into the "Entertainment" or "Navigation" menu to check it. To confirm it is working properly, the bar should be white like the image below.



Fuse Block (Engine Compartment)

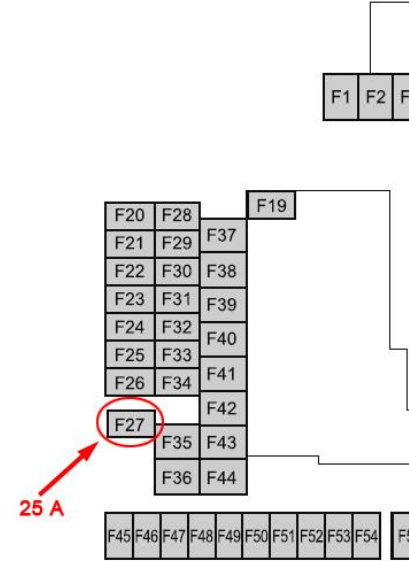

Fuse Block (Left Side)

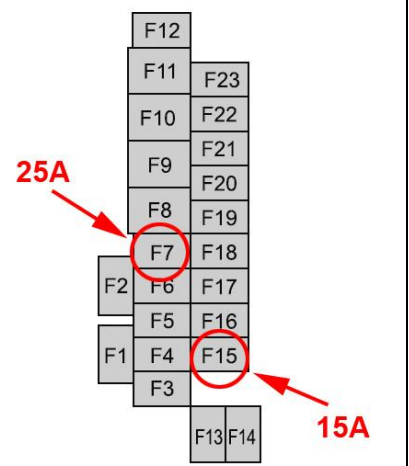

**CONSUMER NOTICE:** The information and instructions in this bulletin are intended for use by skilled technicians. Mazda technicians utilize the proper tools/equipment and take training to correctly and safely maintain Mazda vehicles. These instructions should not be performed by "do-it-yourselfers." Customers should not assume this bulletin applies to their vehicle or that their vehicle will develop the described concern. To determine if the information applies, customers should contact their nearest authorized Mazda dealership. Mazda North American Operations reserves the right to alter the specifications and contents of this bulletin without obligation or advance notice. All rights reserved. No part of this bulletin may be reproduced in any form or by any means, electronic or mechanical---including photocopying and recording and the use of any kind of information storage and retrieval system ---without permission in writing.

**Auxiliary Key**  
 The auxiliary keys need to be inserted into the transmitters during PDI.

Auxiliary Key

Transmitter



**NOTE:** The auxiliary keys are small and could be overlooked during PDI.

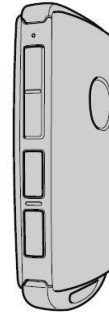

Vehicles arrive at the dealer with Auxiliary Keys located in the glove compartment\*



Vehicles arrive at the dealer with the 2nd transmitter located in the front cup holder

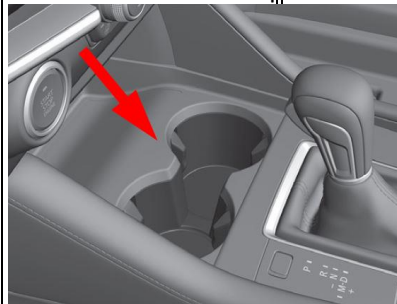

Owner's Manual - Before PDI - Auxiliary key

The 2nd transmitter is located in the trunk (A) or next to the jack (B)

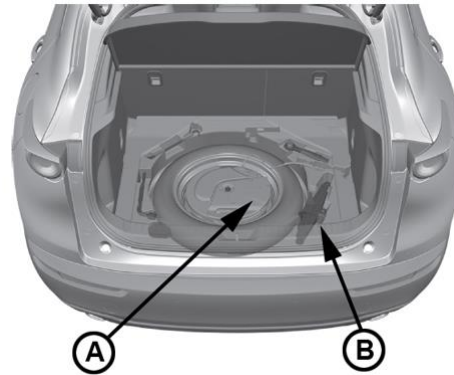

\*Vehicles that arrive at the dealer after business hours, one transmitter is located in the dealer's early bird key drop box.

**CONSUMER NOTICE:** The information and instructions in this bulletin are intended for use by skilled technicians. Mazda technicians utilize the proper tools/equipment and take training to correctly and safely maintain Mazda vehicles. These instructions should not be performed by "do-it-yourselfers." Customers should not assume this bulletin applies to their vehicle or that their vehicle will develop the described concern. To determine if the information applies, customers should contact their nearest authorized Mazda dealership. Mazda North American Operations reserves the right to alter the specifications and contents of this bulletin without obligation or advance notice. All rights reserved. No part of this bulletin may be reproduced in any form or by any means, electronic or mechanical---including photocopying and recording and the use of any kind of information storage and retrieval system ---without permission in writing.

Insert the auxiliary key into the transmitter.

Remove the transmitter lower cover by sliding the knob in the direction shown and then sliding the cover in the opposite direction.



Insert the auxiliary key.

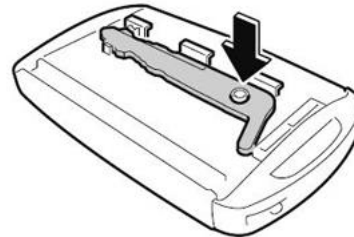

Install the transmitter lower cover by inserting the tabs of the lower cover into the slots of the transmitter.

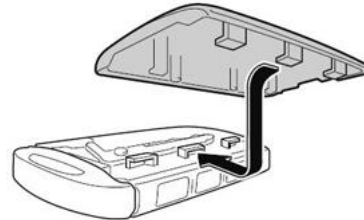

1. If one auxiliary key is lost, some key machines can trace cut a new replacement key.
2. If both auxiliary keys are lost, key cutting machines do not recognize vehicle key code and will not cut new replacement keys. Replace the front door key cylinder set.

**NOTE:** If the front door key cylinder set is replaced, eMDCS system key code information will need to be changed. Contact Helpdesk by phone (949 727-6434) or email (HelpDesk@mazdausa.com) and provide:

1. VIN

**CONSUMER NOTICE:** The information and instructions in this bulletin are intended for use by skilled technicians. Mazda technicians utilize the proper tools/equipment and take training to correctly and safely maintain Mazda vehicles. These instructions should not be performed by "do-it-yourselfers." Customers should not assume this bulletin applies to their vehicle or that their vehicle will develop the described concern. To determine if the information applies, customers should contact their nearest authorized Mazda dealership. Mazda North American Operations reserves the right to alter the specifications and contents of this bulletin without obligation or advance notice. All rights reserved. No part of this bulletin may be reproduced in any form or by any means, electronic or mechanical---including photocopying and recording and the use of any kind of information storage and retrieval system ---without permission in writing.

## 2. Replacement part key code.

Transmitter Note:



1. If one transmitter is lost, inform the customer to take cautions not to lose the 2nd transmitter.
2. If both transmitters are lost, the vehicle will be disabled. Use MDARS to program new transmitters.
3. Replacement battery type is CR2032 (3V, 225mAh), which is different than previous 6th generation transmitter battery type CR2025 (3V, 160mAh). If the wrong battery is installed, the transmitter might not work properly (malfunction).

**CONSUMER NOTICE:** The information and instructions in this bulletin are intended for use by skilled technicians. Mazda technicians utilize the proper tools/equipment and take training to correctly and safely maintain Mazda vehicles. These instructions should not be performed by "do-it-yourselfers." Customers should not assume this bulletin applies to their vehicle or that their vehicle will develop the described concern. To determine if the information applies, customers should contact their nearest authorized Mazda dealership. Mazda North American Operations reserves the right to alter the specifications and contents of this bulletin without obligation or advance notice. All rights reserved. No part of this bulletin may be reproduced in any form or by any means, electronic or mechanical---including photocopying and recording and the use of any kind of information storage and retrieval system ---without permission in writing.

Connected Vehicle

1. Connected Vehicle App remote requests below may take up to a minute to complete.

1. Engine Start
2. Engine Stop
3. Door Lock
4. Door Unlock
5. Quick Flash/Horn On
6. Hazard Off

2. Connected Vehicle App status is not updated in real time for the items below. Updates may take several minutes and may require a manual refresh.

1. Tire Pressure Status (last key cycle)
2. Doors
3. Trunk/Liftgate
4. Hood
5. Hazard Lights

**NOTE:** Tire pressures on the app are from the last time data was received before the ignition was turned off.

3. Multiple remote requests failure

1. Only a single request can be processed per minute.
2. Error messages are displayed if multiple requests are sent within 60 seconds.

Resources:

Educational Videos	Other Resources
<ol style="list-style-type: none"> <li>1. Overview</li> <li>2. MyMazda remote</li> <li>3. Using MyMazda App</li> <li>4. Vehicle Health Notifications</li> <li>5. In-car Wi-Fi</li> <li>6. Saftey features</li> </ol>	<ol style="list-style-type: none"> <li>1. MAZDA CONNECTED SERVICES FAQ</li> <li>2. MAZDA CONNECT and MAZDA CONNE Guide (see attachment)</li> <li>3. MAZDA CONNECTED VEHICLE VIEWER</li> </ol>

Note: Vehicle Maintenance due data is pulled from the vehicles MAZDA CONNECT system. The customer can change the settings at: MAZDA CONNECT - Information - Vehicle Status Monitor - Vehicle Maintenance Settings.

Remote Request

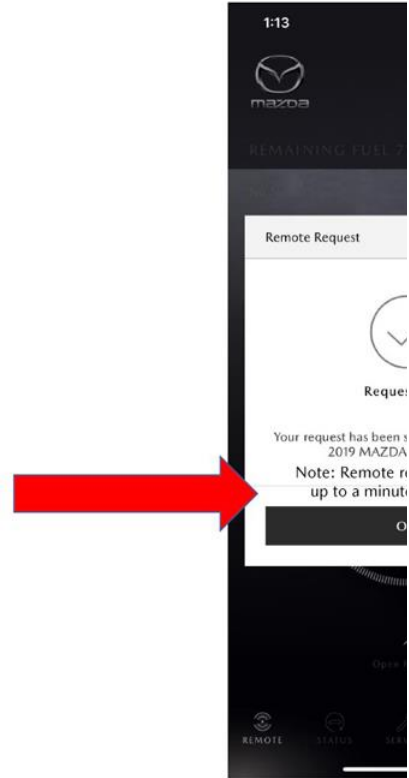

**CONSUMER NOTICE:** The information and instructions in this bulletin are intended for use by skilled technicians. Mazda technicians utilize the proper tools/equipment and take training to correctly and safely maintain Mazda vehicles. These instructions should not be performed by "do-it-yourselfers." Customers should not assume this bulletin applies to their vehicle or that their vehicle will develop the described concern. To determine if the information applies, customers should contact their nearest authorized Mazda dealership. Mazda North American Operations reserves the right to alter the specifications and contents of this bulletin without obligation or advance notice. All rights reserved. No part of this bulletin may be reproduced in any form or by any means, electronic or mechanical---including photocopying and recording and the use of any kind of information storage and retrieval system ---without permission in writing.

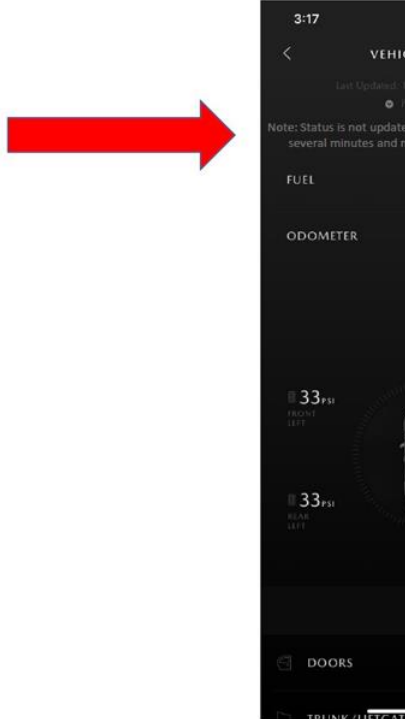
	<p>Vehicle Status</p> 
<p><b>Connected Vehicle Maintenance Mode</b>                  When vehicle is being serviced, switch to Restricted Transmitting Mode.</p> <ol style="list-style-type: none"> <li>1. Restricts MyMazda App remote functions.</li> <li>2. Prevents error messages being sent to the customer during vehicle service.</li> </ol> <p>Cancel Restricted Transmitting Mode after completing vehicle service.</p>	<p>See SA-056/19 - <b>CONNECTED VEHICLE MAINTENANCE MODE</b></p> <p>Go to MGSS SERVICE CAUTIONS FOR VEHICLES WITH TELEMATICS COMMUNICATION SYSTEM [(US)].</p>
<p>Mazda Connected Vehicle Viewer (MCVV)</p> <p>The Mazda Connected Vehicle Viewer (MCVV) enhances the Mazda ownership experience by providing Mazda Service Advisors, Technicians and Call Center Associates access to real-time vehicle status information alerts for applicable Mazda connected vehicles.</p> <p>This powerful tool allows you to proactively understand and diagnose customer concerns and resolve potential issues, demonstrating how well you know the customer’s vehicle while establishing your</p>	<p>MAZDA CONNECTED VEHICLE VIEWER USER GUIDE (MCVV) - see attachment</p>

**CONSUMER NOTICE:** The information and instructions in this bulletin are intended for use by skilled technicians. Mazda technicians utilize the proper tools/equipment and take training to correctly and safely maintain Mazda vehicles. These instructions should not be performed by "do-it-yourselfers." Customers should not assume this bulletin applies to their vehicle or that their vehicle will develop the described concern. To determine if the information applies, customers should contact their nearest authorized Mazda dealership. Mazda North American Operations reserves the right to alter the specifications and contents of this bulletin without obligation or advance notice. All rights reserved. No part of this bulletin may be reproduced in any form or by any means, electronic or mechanical---including photocopying and recording and the use of any kind of information storage and retrieval system ---without permission in writing.



readiness and willingness to assist.

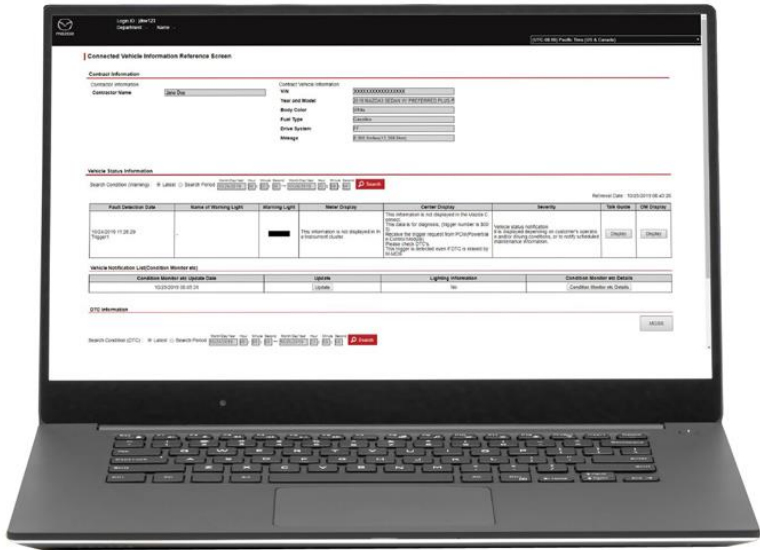

**Off-Road Traction Assist**

1. The Off-Road Traction Assist is a function to assist in freeing tires that are stuck when driving on rough ground (such as gravel roads or snow-covered roads).
2. The driver can switch the system to operational or non-operational using the Off-Road Traction Assist switch.



See MGSS OFF-ROAD TRACTION ASSIST

See Owner's Manual - When Driving - ABS/TCS/DSC/Off-Road - Off-Road Traction Assist

**CONSUMER NOTICE:** The information and instructions in this bulletin are intended for use by skilled technicians. Mazda technicians utilize the proper tools/equipment and take training to correctly and safely maintain Mazda vehicles. These instructions should not be performed by "do-it-yourselfers." Customers should not assume this bulletin applies to their vehicle or that their vehicle will develop the described concern. To determine if the information applies, customers should contact their nearest authorized Mazda dealership. Mazda North American Operations reserves the right to alter the specifications and contents of this bulletin without obligation or advance notice. All rights reserved. No part of this bulletin may be reproduced in any form or by any means, electronic or mechanical---including photocopying and recording and the use of any kind of information storage and retrieval system ---without permission in writing.

Apple CarPlay™ / Android Auto™ Install Kit

1. The CX-30 Standard is not equipped with Apple CarPlay™ / Android Auto™ (Equipped on all Option Packages)
2. Apple CarPlay™ / Android Auto™ Smartphone Screen Mirroring Kit accessory is not available for the CX-30 Standard.

See SA-001/19 - APPLE CARPLAY™ / ANDROID AUTO™ FREQUENTLY ASKED QUESTIONS (FAQ)

Blind Spot Monitoring (BSM) System

1. BSM system indicates vehicle on the opposite side.
  2. i-ACTIVSENSE indicator ring will not turn green
  3. Rear Cross Traffic Alert (RCTA) does not work
  4. Rear side radar sensor aiming may fail
  5. TPMS DTC(s) stored
- This may be caused by BSM rear side radar sensor(s) installed facing the wrong direction.

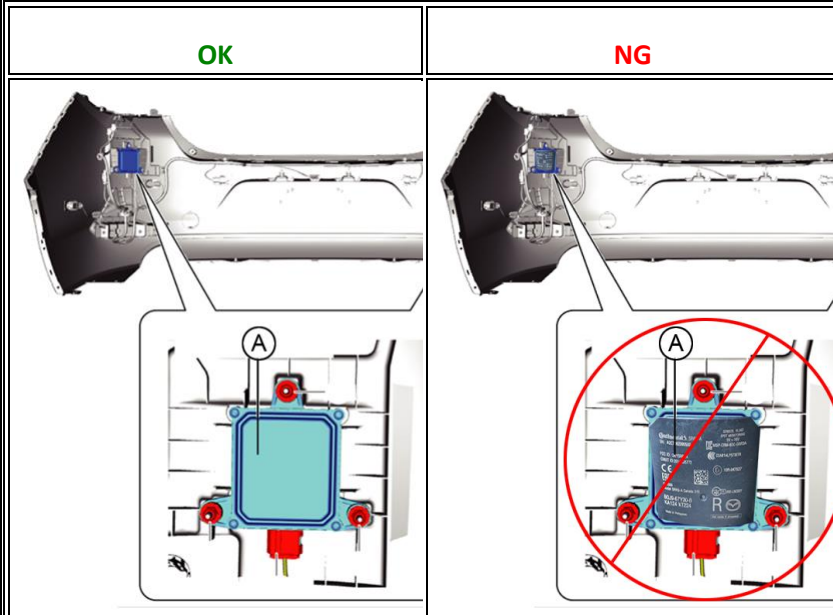

Rear side radar sensors (A) part label must not be visible when installed.

**CONSUMER NOTICE:** The information and instructions in this bulletin are intended for use by skilled technicians. Mazda technicians utilize the proper tools/equipment and take training to correctly and safely maintain Mazda vehicles. These instructions should not be performed by "do-it-yourselfers." Customers should not assume this bulletin applies to their vehicle or that their vehicle will develop the described concern. To determine if the information applies, customers should contact their nearest authorized Mazda dealership. Mazda North American Operations reserves the right to alter the specifications and contents of this bulletin without obligation or advance notice. All rights reserved. No part of this bulletin may be reproduced in any form or by any means, electronic or mechanical---including photocopying and recording and the use of any kind of information storage and retrieval system ---without permission in writing.

Front Wiper Service Caution

1. Wiper arm park position is located under the hood.
2. When servicing front wipers, front wiper service mode is required or damage to wiper arms may occur (see Service Information).
3. If wiper arms are replaced, M-MDS is needed for wiper arm adjustment (see Service Information)
4. DO NOT use wiper arms as markers when in dealer inventory.

See Owner's Manual -  
Maintenance and Care Replacing  
Windshield Wiper Blades

MGSS: WINDSHIELD WIPER ARM  
AND BLADE ADJUSTMENT

**CONSUMER NOTICE:** The information and instructions in this bulletin are intended for use by skilled technicians. Mazda technicians utilize the proper tools/equipment and take training to correctly and safely maintain Mazda vehicles. These instructions should not be performed by "do-it-yourselfers." Customers should not assume this bulletin applies to their vehicle or that their vehicle will develop the described concern. To determine if the information applies, customers should contact their nearest authorized Mazda dealership. Mazda North American Operations reserves the right to alter the specifications and contents of this bulletin without obligation or advance notice. All rights reserved. No part of this bulletin may be reproduced in any form or by any means, electronic or mechanical---including photocopying and recording and the use of any kind of information storage and retrieval system ---without permission in writing.

i-ACTIVSENSE Switch



If none of the systems are activated or if there is a problem with the system, the i-ACTIVSENSE status symbol (warning/risk avoidance support system) (white) is displayed.

Stand-by Status: **White**

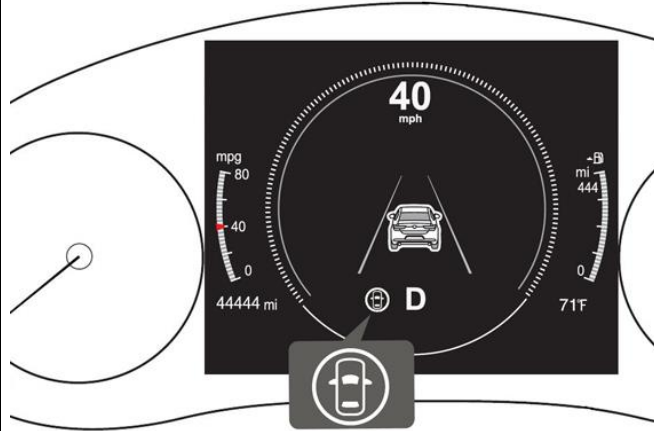

See Owner's Manual- When Driving - i-ACTIVSENSE - i-ACTIVSENSE

If any one of the systems is activated, the i-ACTIVSENSE status symbol (warning/risk avoidance support system)

Activated Status: **Green**

**CONSUMER NOTICE:** The information and instructions in this bulletin are intended for use by skilled technicians. Mazda technicians utilize the proper tools/equipment and take training to correctly and safely maintain Mazda vehicles. These instructions should not be performed by "do-it-yourselfers." Customers should not assume this bulletin applies to their vehicle or that their vehicle will develop the described concern. To determine if the information applies, customers should contact their nearest authorized Mazda dealership. Mazda North American Operations reserves the right to alter the specifications and contents of this bulletin without obligation or advance notice. All rights reserved. No part of this bulletin may be reproduced in any form or by any means, electronic or mechanical---including photocopying and recording and the use of any kind of information storage and retrieval system ---without permission in writing.

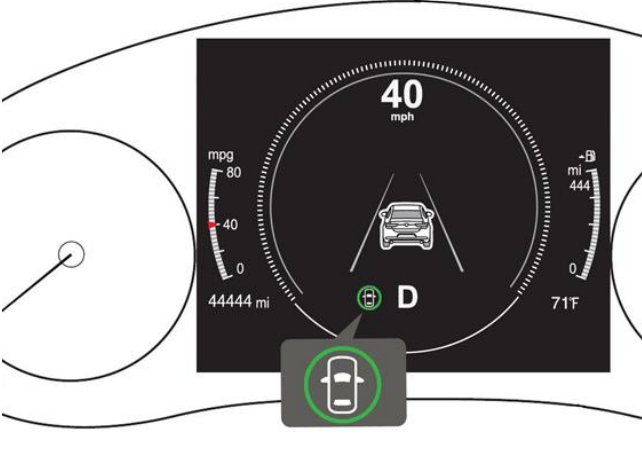
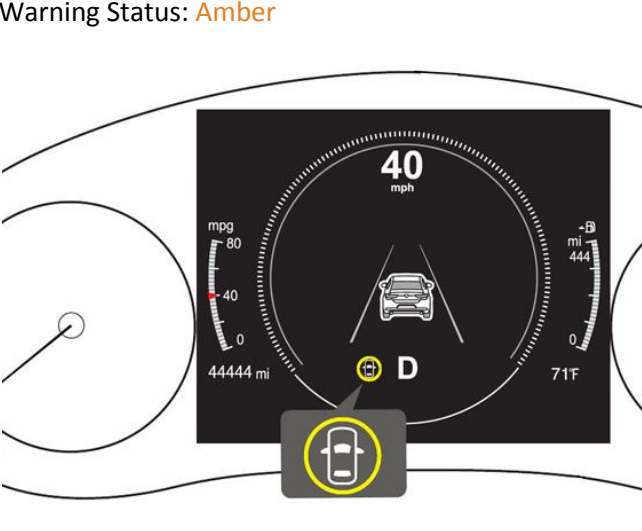
<p>(green) is displayed.</p>	 <p>The instrument cluster shows a speedometer at 40 mph, a tachometer on the left, and a fuel gauge on the right. A green car icon with a green outline is illuminated at the bottom center of the cluster, indicating the i-Activsense system is active.</p>	
<p>If any system warning is activated, the i-ACTIVSENSE status symbol (warning/risk avoidance support system) (amber) is displayed.</p>	<p>Warning Status: <b>Amber</b></p>  <p>The instrument cluster is identical to the first image, but the car icon at the bottom center is now illuminated in amber, indicating a warning status.</p>	
<p>When the i-ACTIVSENSE switch is pressed, the following systems are <b>OFF</b> and the i-ACTIVSENSE OFF indicator illuminates.</p>	<p><b>OFF (Cancelled Status):</b> I-ACTIVSENSE OFF INDICATOR IS ILLUMINATED</p>	

**CONSUMER NOTICE:** The information and instructions in this bulletin are intended for use by skilled technicians. Mazda technicians utilize the proper tools/equipment and take training to correctly and safely maintain Mazda vehicles. These instructions should not be performed by "do-it-yourselfers." Customers should not assume this bulletin applies to their vehicle or that their vehicle will develop the described concern. To determine if the information applies, customers should contact their nearest authorized Mazda dealership. Mazda North American Operations reserves the right to alter the specifications and contents of this bulletin without obligation or advance notice. All rights reserved. No part of this bulletin may be reproduced in any form or by any means, electronic or mechanical---including photocopying and recording and the use of any kind of information storage and retrieval system ---without permission in writing.

<ol style="list-style-type: none"> <li>1. Lane Departure Warning System (LDWS)</li> <li>2. Blind Spot Monitoring (BSM)</li> <li>3. Distance Speed Alert (DSA)</li> <li>4. Rear Cross Traffic Alert (RCTA)</li> <li>5. Lane-keep Assist System (LAS)</li> </ol> <p>To turn the system back to <b>ON</b>, press the i-<b>ACTIVSENSE</b> switch once.</p> <p><b>NOTE:</b></p> <ol style="list-style-type: none"> <li>1. When the ignition is turned OFF - ON, i-<b>ACTIVSENSE</b></li> </ol>	
---	--

**CONSUMER NOTICE:** The information and instructions in this bulletin are intended for use by skilled technicians. Mazda technicians utilize the proper tools/equipment and take training to correctly and safely maintain Mazda vehicles. These instructions should not be performed by "do-it-yourselfers." Customers should not assume this bulletin applies to their vehicle or that their vehicle will develop the described concern. To determine if the information applies, customers should contact their nearest authorized Mazda dealership. Mazda North American Operations reserves the right to alter the specifications and contents of this bulletin without obligation or advance notice. All rights reserved. No part of this bulletin may be reproduced in any form or by any means, electronic or mechanical---including photocopying and recording and the use of any kind of information storage and retrieval system ---without permission in writing.

<p>switches to <b>ON</b>.</p> <p>2. If MRCC is activated, i- ACTIVSE NSE switches to <b>ON</b>.</p> <p>3. When MRCC is deactivated, i- ACTIVSE NSE remains <b>ON</b>.</p> <p>4. The i- ACTIVSE NSE switch does not cancel SBS. SBS can be deactivated using infotainment system settings.</p>		

**CONSUMER NOTICE:** The information and instructions in this bulletin are intended for use by skilled technicians. Mazda technicians utilize the proper tools/equipment and take training to correctly and safely maintain Mazda vehicles. These instructions should not be performed by "do-it-yourselfers." Customers should not assume this bulletin applies to their vehicle or that their vehicle will develop the described concern. To determine if the information applies, customers should contact their nearest authorized Mazda dealership. Mazda North American Operations reserves the right to alter the specifications and contents of this bulletin without obligation or advance notice. All rights reserved. No part of this bulletin may be reproduced in any form or by any means, electronic or mechanical---including photocopying and recording and the use of any kind of information storage and retrieval system ---without permission in writing.

Traffic Sign Recognition (TSR) \*

**NOTE:**

1. TSR function is only available with a dealer installed in-vehicle navigation system accessory.
2. TSR function requires Forward Sensing Camera (FSC) recognition or navigation SD card map data when the vehicle is driven.\*\*
3. TSR function is not displayed in the Active Driving Display.
4. TSR function is disabled when Apple CarPlay™ or Android Auto™ is connected.

\* Some models

MAZDA CONNECT  
Speed Limit Alert OFF  
(Default Setting)

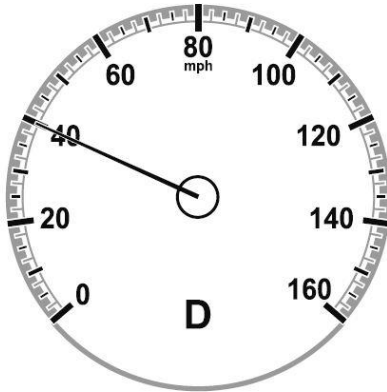

No Function

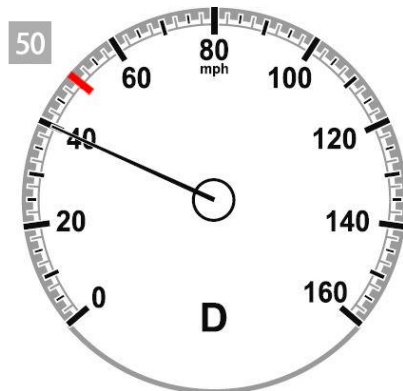

Driving under the speed limit

See Owner's Manual - When Driving - i-ACTIVSENSE - i-ACTIVSENSE - Traffic Sign Recognition System (TSR)

MGSS: Traffic Sign Recognition (TSR)

**CONSUMER NOTICE:** The information and instructions in this bulletin are intended for use by skilled technicians. Mazda technicians utilize the proper tools/equipment and take training to correctly and safely maintain Mazda vehicles. These instructions should not be performed by "do-it-yourselfers." Customers should not assume this bulletin applies to their vehicle or that their vehicle will develop the described concern. To determine if the information applies, customers should contact their nearest authorized Mazda dealership. Mazda North American Operations reserves the right to alter the specifications and contents of this bulletin without obligation or advance notice. All rights reserved. No part of this bulletin may be reproduced in any form or by any means, electronic or mechanical---including photocopying and recording and the use of any kind of information storage and retrieval system ---without permission in writing.



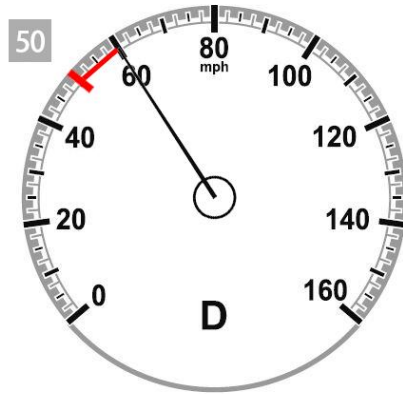

Driving over the speed limit

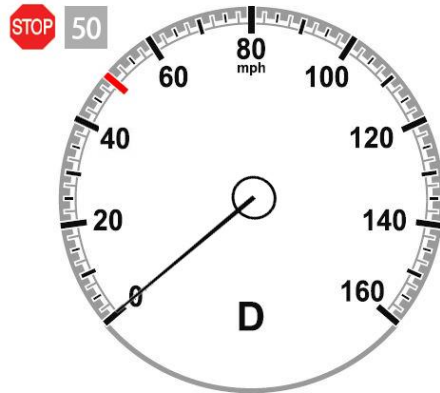

Stop sign and Speed Limit recognized

**CONSUMER NOTICE:** The information and instructions in this bulletin are intended for use by skilled technicians. Mazda technicians utilize the proper tools/equipment and take training to correctly and safely maintain Mazda vehicles. These instructions should not be performed by "do-it-yourselfers." Customers should not assume this bulletin applies to their vehicle or that their vehicle will develop the described concern. To determine if the information applies, customers should contact their nearest authorized Mazda dealership. Mazda North American Operations reserves the right to alter the specifications and contents of this bulletin without obligation or advance notice. All rights reserved. No part of this bulletin may be reproduced in any form or by any means, electronic or mechanical---including photocopying and recording and the use of any kind of information storage and retrieval system ---without permission in writing.

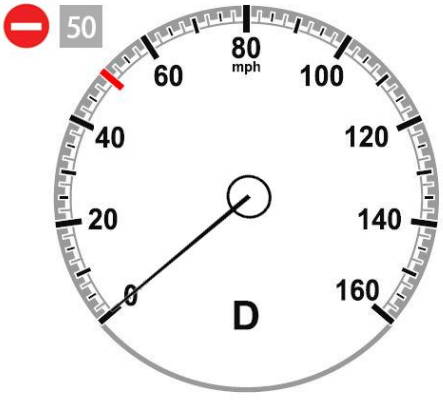
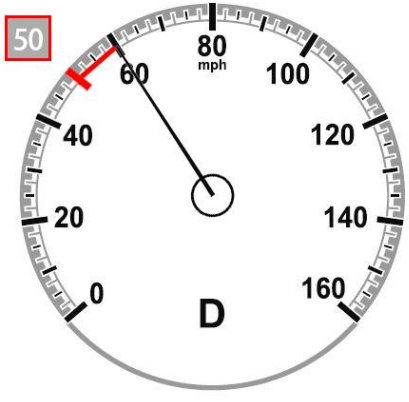
	 <p>Do Not Enter sign and Speed Limit recognized</p>	
<p>MAZDA CONNECT Speed Limit Alert ON (Customer Setting Change)</p>	 <p>Excessive Speed Warning</p>	
<p><b>MAZDA CONNECT Speed Limit Alert Customer Settings</b></p> <ol style="list-style-type: none"> <li>1. Speed Limit Alert Settings             <ol style="list-style-type: none"> <li>1. OFF</li> <li>2. Visual</li> <li>3. Visual + Audible</li> </ol> </li> <li>2. Speed Limit Alert Threshold             <ol style="list-style-type: none"> <li>1. 0 mph</li> <li>2. +5 mph</li> <li>3. +10 mph</li> </ol> </li> </ol> <p>** SD Card maps may contain information about the speed limits of the roads. The navigation system is able to warn driver if they exceed</p>		

**CONSUMER NOTICE:** The information and instructions in this bulletin are intended for use by skilled technicians. Mazda technicians utilize the proper tools/equipment and take training to correctly and safely maintain Mazda vehicles. These instructions should not be performed by "do-it-yourselfers." Customers should not assume this bulletin applies to their vehicle or that their vehicle will develop the described concern. To determine if the information applies, customers should contact their nearest authorized Mazda dealership. Mazda North American Operations reserves the right to alter the specifications and contents of this bulletin without obligation or advance notice. All rights reserved. No part of this bulletin may be reproduced in any form or by any means, electronic or mechanical---including photocopying and recording and the use of any kind of information storage and retrieval system ---without permission in writing.

the current limit. This information may not be available in some areas or may not be fully correct for all roads on the map.

**CONSUMER NOTICE:** The information and instructions in this bulletin are intended for use by skilled technicians. Mazda technicians utilize the proper tools/equipment and take training to correctly and safely maintain Mazda vehicles. These instructions should not be performed by "do-it-yourselfers." Customers should not assume this bulletin applies to their vehicle or that their vehicle will develop the described concern. To determine if the information applies, customers should contact their nearest authorized Mazda dealership. Mazda North American Operations reserves the right to alter the specifications and contents of this bulletin without obligation or advance notice. All rights reserved. No part of this bulletin may be reproduced in any form or by any means, electronic or mechanical---including photocopying and recording and the use of any kind of information storage and retrieval system ---without permission in writing.

### MAZDA CONNECT New Power Off Function



1. Audio Mute - Short press the volume knob (Press again to cancel)
2. Power Off - Press and hold the volume knob (Press and hold again to Power ON)

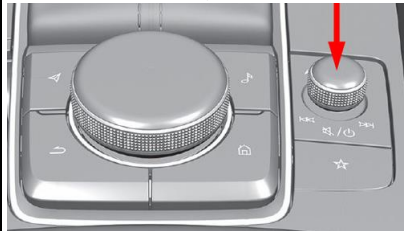

See Owner's Manual -  
Interior Features - Mazda  
Connect

MGSS: ENTERTAINMENT SYSTEM

**CONSUMER NOTICE:** The information and instructions in this bulletin are intended for use by skilled technicians. Mazda technicians utilize the proper tools/equipment and take training to correctly and safely maintain Mazda vehicles. These instructions should not be performed by "do-it-yourselfers." Customers should not assume this bulletin applies to their vehicle or that their vehicle will develop the described concern. To determine if the information applies, customers should contact their nearest authorized Mazda dealership. Mazda North American Operations reserves the right to alter the specifications and contents of this bulletin without obligation or advance notice. All rights reserved. No part of this bulletin may be reproduced in any form or by any means, electronic or mechanical---including photocopying and recording and the use of any kind of information storage and retrieval system ---without permission in writing.

**MAZDA CONNECT Center Display View**

The rear-view monitor does not utilize all of the center display space.

Function	Display
Rear View Monitor	
MAZDA CONNECT FM	
Apple CarPlay	
Android Auto	

**CONSUMER NOTICE:** The information and instructions in this bulletin are intended for use by skilled technicians. Mazda technicians utilize the proper tools/equipment and take training to correctly and safely maintain Mazda vehicles. These instructions should not be performed by "do-it-yourselfers." Customers should not assume this bulletin applies to their vehicle or that their vehicle will develop the described concern. To determine if the information applies, customers should contact their nearest authorized Mazda dealership. Mazda North American Operations reserves the right to alter the specifications and contents of this bulletin without obligation or advance notice. All rights reserved. No part of this bulletin may be reproduced in any form or by any means, electronic or mechanical---including photocopying and recording and the use of any kind of information storage and retrieval system ---without permission in writing.

### In-Vehicle Digital Owner's Manual

The in-vehicle digital OM can be displayed on the center display while the vehicle is stopped. Customer can search descriptions and watch videos of vehicle features and functions by operating the commander switch.



#### NOTE:

1. The digital owner's manual must be installed during PDI. Due to printing deadlines and later updates to the digital manual, the content of the digital manual may differ from the printed manual.
  1. DO NOT use the same file as Mazda3. Check MGSS and retrieve the correct file for the CX-30.
2. USB memory flash drive FAT16 or FAT32 format is required for installation.
3. The vehicle's infotainment system will only accept file names [contents.tar] and [contents.sig]. File names with additional suffixes will not be accepted.
4. The infotainment system may inadvertently be powered OFF if the diagnostic assist function buttons are not pressed correctly. Simply press and hold the volume knob to power back ON.

**CONSUMER NOTICE:** The information and instructions in this bulletin are intended for use by skilled technicians. Mazda technicians utilize the proper tools/equipment and take training to correctly and safely maintain Mazda vehicles. These instructions should not be performed by "do-it-yourselfers." Customers should not assume this bulletin applies to their vehicle or that their vehicle will develop the described concern. To determine if the information applies, customers should contact their nearest authorized Mazda dealership. Mazda North American Operations reserves the right to alter the specifications and contents of this bulletin without obligation or advance notice. All rights reserved. No part of this bulletin may be reproduced in any form or by any means, electronic or mechanical---including photocopying and recording and the use of any kind of information storage and retrieval system ---without permission in writing.

Navigation System

The 2020 CX-30 7th generation (Gen 7) infotainment system is not equipped with factory installed navigation system, however, it is available as a dealer installed accessory.

**NOTE:** The Gen 7 accessory navigation SD card is made in Japan instead of USA. The USA made navigation SD card (Gen 6.5) will not function in a Gen 7 vehicle.



Gen 7



Gen 6.5

SIRIUSXM Data Service No Free Trial (Preferred Package and above)

1. Only available as a paid subscription.
2. SiriusXM Traffic Plus feature requires in-vehicle navigation SD card.
3. The 2020 CX-30 is not equipped with a factory installed navigation system, however, it is available as a dealer installed accessory.

See Owner's Manual - Interior Features - Mazda Connect - Appendix

SA-007/19 - SIRIUSXM DATA SERVICES

**CONSUMER NOTICE:** The information and instructions in this bulletin are intended for use by skilled technicians. Mazda technicians utilize the proper tools/equipment and take training to correctly and safely maintain Mazda vehicles. These instructions should not be performed by "do-it-yourselfers." Customers should not assume this bulletin applies to their vehicle or that their vehicle will develop the described concern. To determine if the information applies, customers should contact their nearest authorized Mazda dealership. Mazda North American Operations reserves the right to alter the specifications and contents of this bulletin without obligation or advance notice. All rights reserved. No part of this bulletin may be reproduced in any form or by any means, electronic or mechanical---including photocopying and recording and the use of any kind of information storage and retrieval system ---without permission in writing.

**Power Door Locks**

Doors cannot be unlocked using the outside door handle touch sensor

The door handle touch sensor system may not operate normally under the following conditions:

1. The front passenger (without key) grabs and holds the outside door handle before the driver (with key) touches the drivers outside door handle unlock touch sensor.
2. The driver touches the sensing area of the door lock touch sensor and the sensing area of the door release touch sensor at the same time.

See Owner's Manual -  
Before Driving - Doors and Locks

Good

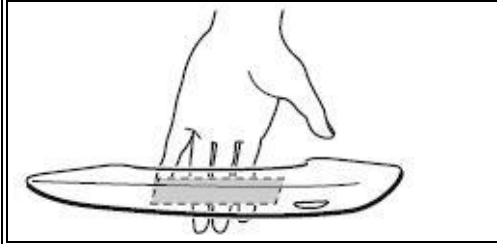

No Good

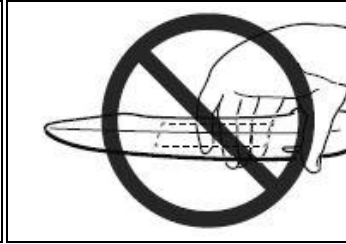

**CONSUMER NOTICE:** The information and instructions in this bulletin are intended for use by skilled technicians. Mazda technicians utilize the proper tools/equipment and take training to correctly and safely maintain Mazda vehicles. These instructions should not be performed by "do-it-yourselfers." Customers should not assume this bulletin applies to their vehicle or that their vehicle will develop the described concern. To determine if the information applies, customers should contact their nearest authorized Mazda dealership. Mazda North American Operations reserves the right to alter the specifications and contents of this bulletin without obligation or advance notice. All rights reserved. No part of this bulletin may be reproduced in any form or by any means, electronic or mechanical---including photocopying and recording and the use of any kind of information storage and retrieval system ---without permission in writing.



**Transmitter Battery Saving Function (Key Fob)**

The CX-30 has a "power saving" function built into the keyless entry system where **some** key fob functions are disabled. This feature could accidentally be enabled and some concerns with the vehicle may be:

1. Engine does not start.
2. Engine does not start unless you hold the fob to the start/stop button.
3. Doors do not unlock using the door handle, but unlock with the remote.
4. Doors do not lock using the door handle, but lock with the remote.
5. Transmitter indicator light does not turn on/flash.

Turning on the power saving function  
 After you have turned on the power saving function according to the following procedure, the hazard warning lights and sound operate\* one time.

1. Press the lock button on the transmitter 4 times within 3 seconds to turn on the operation indicator light.
2. Press the lock button continuously for 1.5 seconds or longer while the operation indicator light turns on (for 5 seconds).
3. Press any of the buttons on the transmitter to make sure that the operation indicator light does not turn on/flash.

Turning off the power saving function  
 After you have turned off the power saving function according to the following procedure, the hazard warning lights and sound operate\* one time.

1. Press any of the buttons on the transmitter to make sure that the operation indicator light does not turn on/flash.
2. Press the lock button on the transmitter 4 times within 3 seconds to turn on the operation indicator light.
3. Press the lock button continuously for 1.5 seconds or

**CONSUMER NOTICE:** The information and instructions in this bulletin are intended for use by skilled technicians. Mazda technicians utilize the proper tools/equipment and take training to correctly and safely maintain Mazda vehicles. These instructions should not be performed by "do-it-yourselfers." Customers should not assume this bulletin applies to their vehicle or that their vehicle will develop the described concern. To determine if the information applies, customers should contact their nearest authorized Mazda dealership. Mazda North American Operations reserves the right to alter the specifications and contents of this bulletin without obligation or advance notice. All rights reserved. No part of this bulletin may be reproduced in any form or by any means, electronic or mechanical---including photocopying and recording and the use of any kind of information storage and retrieval system ---without permission in writing.

	<p>longer while the operation indicator light turns on (for 5 seconds).</p> <p>*: with the advanced keyless function</p> <p>Also see Owner's Manual - Before Driving - Keys - Power saving function</p>
--	---

**CONSUMER NOTICE:** The information and instructions in this bulletin are intended for use by skilled technicians. Mazda technicians utilize the proper tools/equipment and take training to correctly and safely maintain Mazda vehicles. These instructions should not be performed by "do-it-yourselfers." Customers should not assume this bulletin applies to their vehicle or that their vehicle will develop the described concern. To determine if the information applies, customers should contact their nearest authorized Mazda dealership. Mazda North American Operations reserves the right to alter the specifications and contents of this bulletin without obligation or advance notice. All rights reserved. No part of this bulletin may be reproduced in any form or by any means, electronic or mechanical---including photocopying and recording and the use of any kind of information storage and retrieval system ---without permission in writing.

**Keyless Entry Using Auxiliary Key**

If the vehicle battery is discharged and/or the key battery is dead, vehicle entry is possible using the auxiliary key.

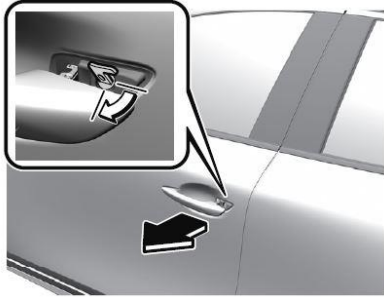

See Owner's Manual -  
Before Driving - Keys - Auxiliary  
Key

Then refer to Owner's Manual -  
Before Driving - Doors and Locks -  
Unlocking with Auxiliary Key

**Rear Door Child Safety Locks Operation**

The auxiliary key is required to enable (lock) and disable (unlock) the rear door child safety locks.



1. Auxiliary Key

2. Lock

3. Unlock

See Owner's Manual -  
Before Driving - Doors and Locks -  
Rear Door Child Safety Locks

**CONSUMER NOTICE:** The information and instructions in this bulletin are intended for use by skilled technicians. Mazda technicians utilize the proper tools/equipment and take training to correctly and safely maintain Mazda vehicles. These instructions should not be performed by "do-it-yourselfers." Customers should not assume this bulletin applies to their vehicle or that their vehicle will develop the described concern. To determine if the information applies, customers should contact their nearest authorized Mazda dealership. Mazda North American Operations reserves the right to alter the specifications and contents of this bulletin without obligation or advance notice. All rights reserved. No part of this bulletin may be reproduced in any form or by any means, electronic or mechanical---including photocopying and recording and the use of any kind of information storage and retrieval system ---without permission in writing.

### Theft-Deterrent System



The CX-30 is not equipped with a Theft-Deterrent System. **CAUTION:** DO NOT use MDARS to enable:

- 1. Burglar Alarm
- 2. Intrusion Sensor

The CX-30 does not have the necessary Theft-Deterrent System hardware to function if enabled using MDARS, and MDARS cannot disable the Theft-Deterrent System after it has been enabled.

The following DTC's may be stored if the burglar alarm or intrusion sensor are enabled:

- 1. B109F:87 - Intrusion Sensor Module
- 2. B2002:87 - On Board Charger DC/DC Low Voltage Side

Contact Hotline if the Theft-Deterrent System has been accidentally enabled.

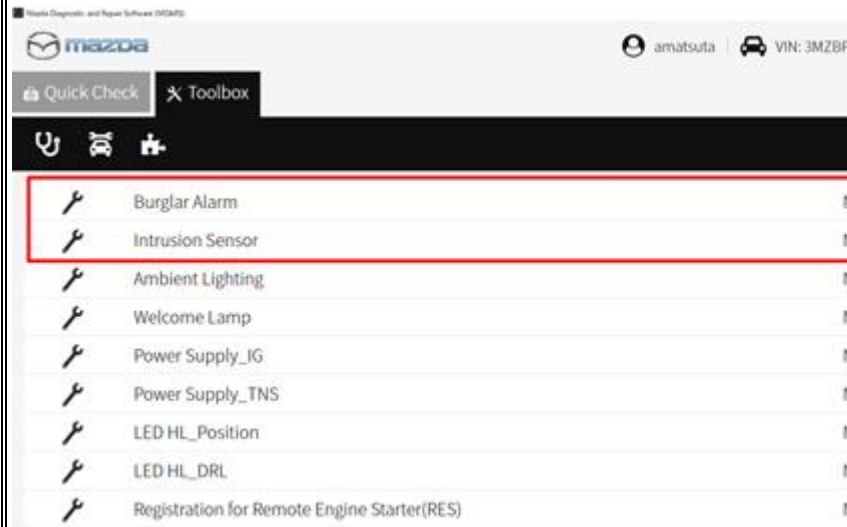

---

**CONSUMER NOTICE:** The information and instructions in this bulletin are intended for use by skilled technicians. Mazda technicians utilize the proper tools/equipment and take training to correctly and safely maintain Mazda vehicles. These instructions should not be performed by "do-it-yourselfers." Customers should not assume this bulletin applies to their vehicle or that their vehicle will develop the described concern. To determine if the information applies, customers should contact their nearest authorized Mazda dealership. Mazda North American Operations reserves the right to alter the specifications and contents of this bulletin without obligation or advance notice. All rights reserved. No part of this bulletin may be reproduced in any form or by any means, electronic or mechanical---including photocopying and recording and the use of any kind of information storage and retrieval system ---without permission in writing.

**Seat Warmer and Heated Steering Wheel Auto Mode**  
 The driver and front passenger's seater warmers\* and the heated steering wheel\* can be set to be automatically controlled (turned on and off) by the climate control system, depending on the set temperature.

**Auto Mode**

1. Go to MAZDA CONNECT home screen and select "Settings"
2. Select "Vehicle Settings".
3. Enable "Link Seat Climate Control Temperatures".
4. Press the climate control AUTO switch.

Link Seat Climate Control Temperatures Setting



Climate Control Auto Switch



See Owner's Manual - Essential Safety Equipment - Seat Warmer/Heated Steering Wheel - Seat Warmer / Heated Steering Wheel

\* if equipped

**Seat Warmer Will Not Turn ON After Previous Usage or being parked under the hot sun.**

1. DTC B1030:13 (SEAT WARMER UNIT (LH) CIRCUIT MALFUNCTION (HEATER SIDE)) is stored.
2. Front seat warmer functions after seat cool down and ignition OFF - ON cycle.

Contact Hotline for latest repair information.

---

**CONSUMER NOTICE:** The information and instructions in this bulletin are intended for use by skilled technicians. Mazda technicians utilize the proper tools/equipment and take training to correctly and safely maintain Mazda vehicles. These instructions should not be performed by "do-it-yourselfers." Customers should not assume this bulletin applies to their vehicle or that their vehicle will develop the described concern. To determine if the information applies, customers should contact their nearest authorized Mazda dealership. Mazda North American Operations reserves the right to alter the specifications and contents of this bulletin without obligation or advance notice. All rights reserved. No part of this bulletin may be reproduced in any form or by any means, electronic or mechanical---including photocopying and recording and the use of any kind of information storage and retrieval system ---without permission in writing.

Electric Parking Brake (EPB)

Parking Brake Auto Operation

When the ignition is switched OFF, the parking brake will be applied automatically. The EPB indicator light in the instrument cluster and the EPB switch indicator light turn ON.



1. Indicator light

Canceling the Parking Brake Auto Operation

Parking brake auto operation can be canceled using the procedure in the Owner's Manual.

**NOTE:** When the ignition is cycled back ON, the parking brake auto operation is restored.

Parking Brake Automatic Release

If the accelerator pedal is depressed with the parking brake applied and all of the following conditions are met, the parking brake is automatically release. When the parking brake is released, the EPB indicator light in the instrument cluster and the EPB switch indicator light turn off.

Engine is running

Driver's door is closed

Driver's seat belt is fastened

Selector lever is in the D, M, or R position

See Owner's Manual - When Driving - Brake - EPB Auto operation

**CONSUMER NOTICE:** The information and instructions in this bulletin are intended for use by skilled technicians. Mazda technicians utilize the proper tools/equipment and take training to correctly and safely maintain Mazda vehicles. These instructions should not be performed by "do-it-yourselfers." Customers should not assume this bulletin applies to their vehicle or that their vehicle will develop the described concern. To determine if the information applies, customers should contact their nearest authorized Mazda dealership. Mazda North American Operations reserves the right to alter the specifications and contents of this bulletin without obligation or advance notice. All rights reserved. No part of this bulletin may be reproduced in any form or by any means, electronic or mechanical---including photocopying and recording and the use of any kind of information storage and retrieval system ---without permission in writing.

Tire Pressure Monitoring System (TPMS) Change

The TPMS system uses a new rubber type direct TPMS.

**NOTE:** The new rubber type is not reusable. If the TPMS sensor is removed from the wheel, it must be replaced.



New Rubber Type      Old Metal Type

MGSS: TIRE PRESSURE MONITORING SYSTEM (TPMS)

Condition Based Maintenance (Except Canada)

The vehicle calculates the maintenance (oil change) timing.

1. This function cannot be turned OFF.
2. Distance until the oil change is available in MAZDA CONNECT.
3. **Reset is required after every oil change.**

MGSS: MAINTENANCE MONITOR OPERATION PROCEDURE

New M-MDS (MDARS)

A new M-MDS diagnostic tester (MDARS) for 7th generation vehicles (starting with the 2019 Mazda3) is used.

1. Performs more maintenance service functions
2. Performs more complicated vehicle electrical system diagnostic
3. Reprograms more ECU's

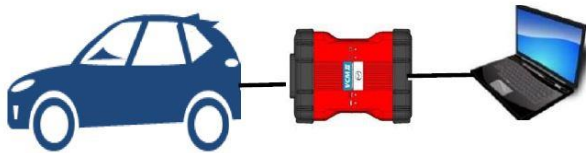

MGSS: BASIC KNOWLEDGE

**CONSUMER NOTICE:** The information and instructions in this bulletin are intended for use by skilled technicians. Mazda technicians utilize the proper tools/equipment and take training to correctly and safely maintain Mazda vehicles. These instructions should not be performed by "do-it-yourselfers." Customers should not assume this bulletin applies to their vehicle or that their vehicle will develop the described concern. To determine if the information applies, customers should contact their nearest authorized Mazda dealership. Mazda North American Operations reserves the right to alter the specifications and contents of this bulletin without obligation or advance notice. All rights reserved. No part of this bulletin may be reproduced in any form or by any means, electronic or mechanical---including photocopying and recording and the use of any kind of information storage and retrieval system ---without permission in writing.

**Parts Replacement**

When replacing vehicle parts such as ECU's, motors, seats....etc, always refer to MGSS. Some new components may not operate if MGSS new part replacement procedure is not performed.

---

## 2020 CX-30 Web-Based Training Courses

Course	Description
30070	2020 Mazda CX-30 Exclusive Preview
30071	Mazda Premium
30072	Performance: Effortless, Joyful Driving
30073	Exterior: Artful Design
30074	Interior: Human Centricity
30075	Skyactiv® Philosophy
30076	Mazda Connect Essentials Web-based Training Course

**CONSUMER NOTICE:** The information and instructions in this bulletin are intended for use by skilled technicians. Mazda technicians utilize the proper tools/equipment and take training to correctly and safely maintain Mazda vehicles. These instructions should not be performed by "do-it-yourselfers." Customers should not assume this bulletin applies to their vehicle or that their vehicle will develop the described concern. To determine if the information applies, customers should contact their nearest authorized Mazda dealership. Mazda North American Operations reserves the right to alter the specifications and contents of this bulletin without obligation or advance notice. All rights reserved. No part of this bulletin may be reproduced in any form or by any means, electronic or mechanical---including photocopying and recording and the use of any kind of information storage and retrieval system ---without permission in writing.