

Note:
Vacuum Ports were installed too close to MorRyde Step Bracket and won't open.

**Note:
Step Bracket impedes opening vacuum port**

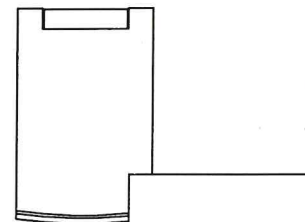

**Note:
Step Bracket impedes
opening vacuum port**

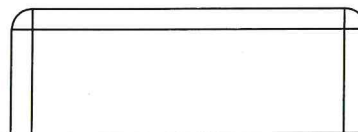
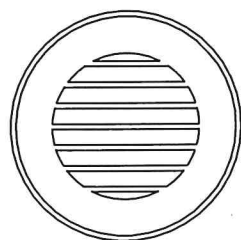
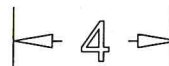
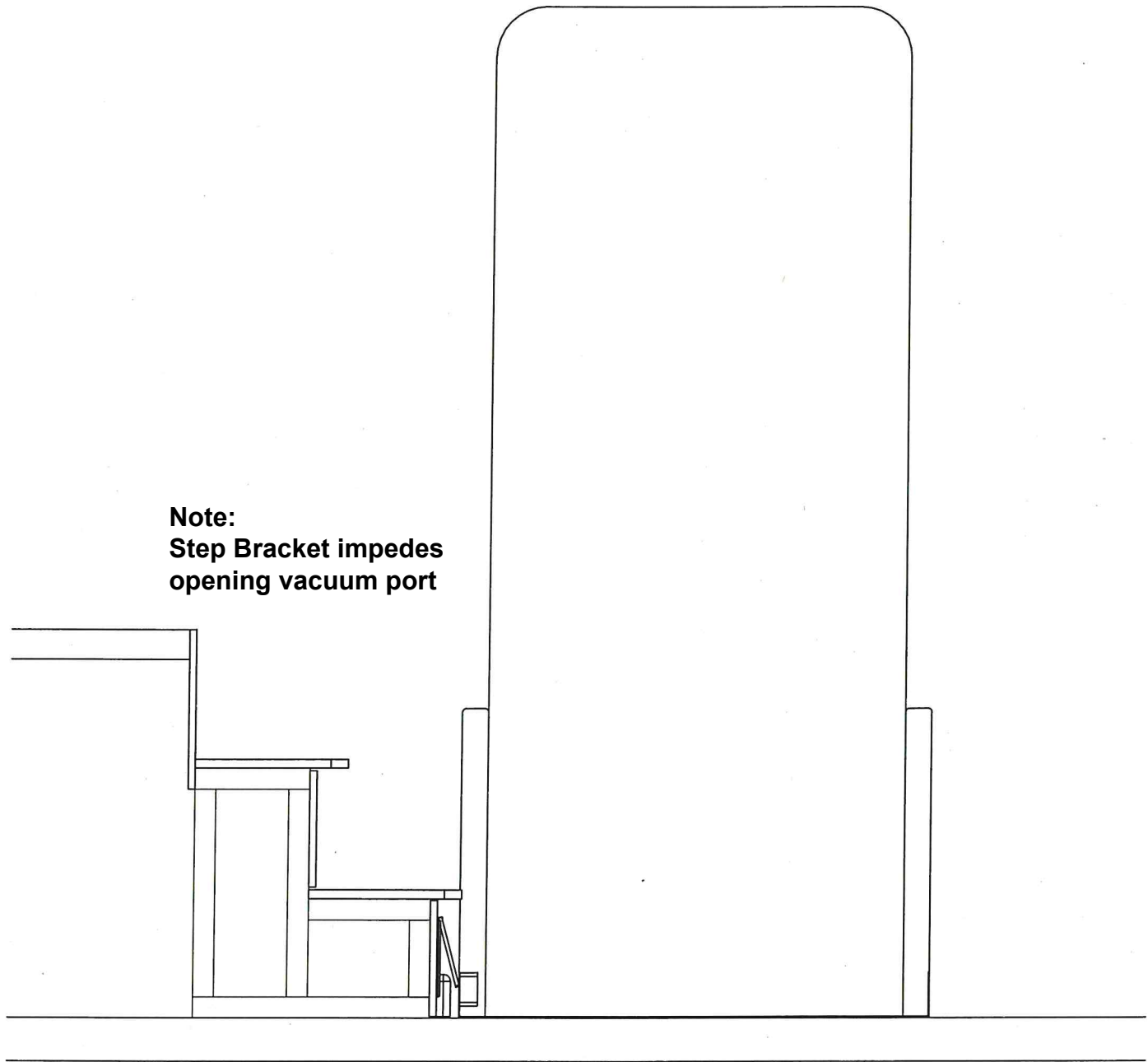

Note:
Vacuum Port Need to move at least
1" inboard, away from sidewall.

5
MIN.

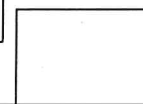
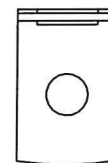
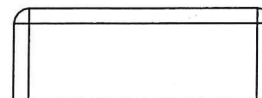
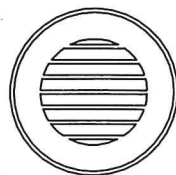

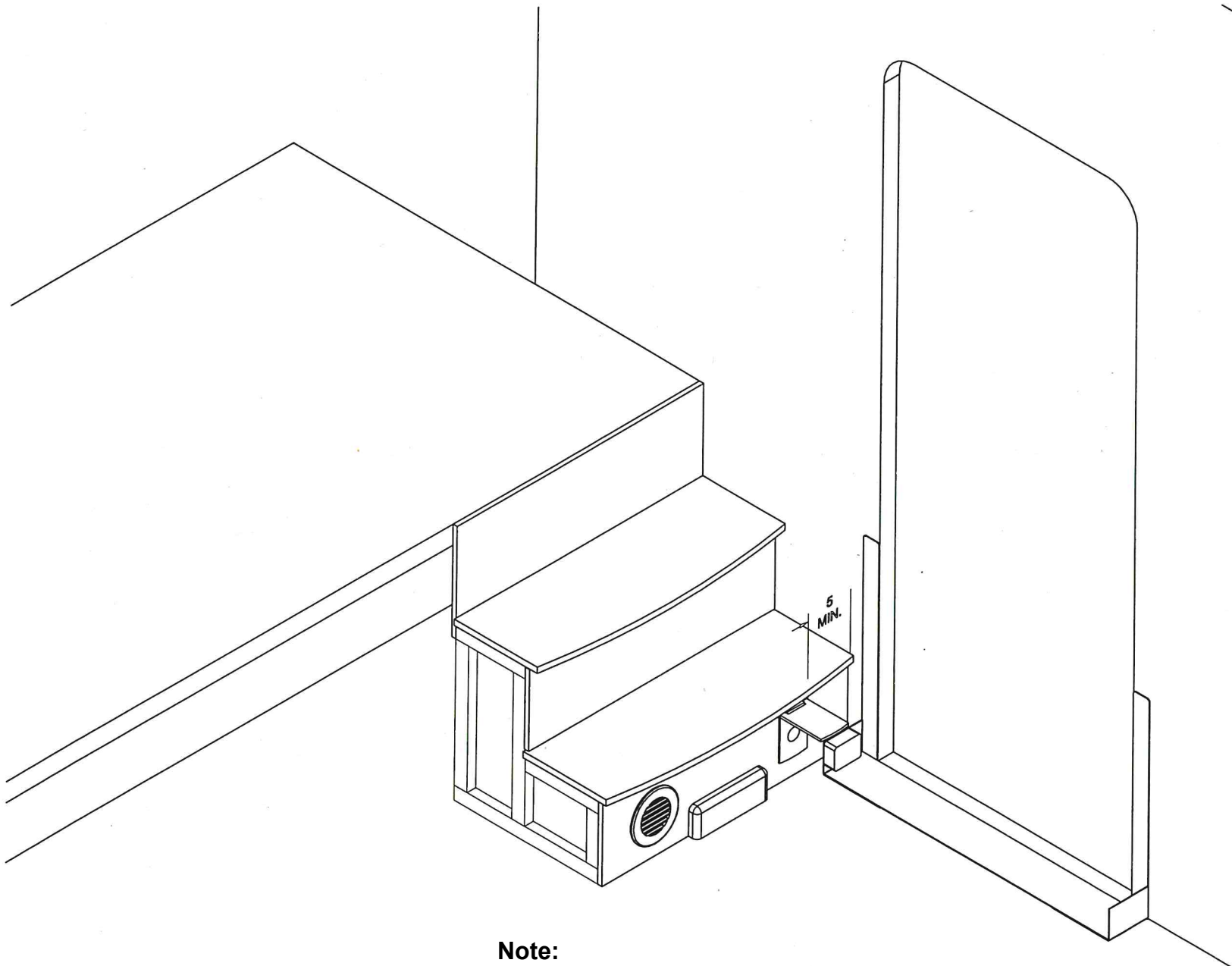

Note:
Moving 1" will allow it to open.

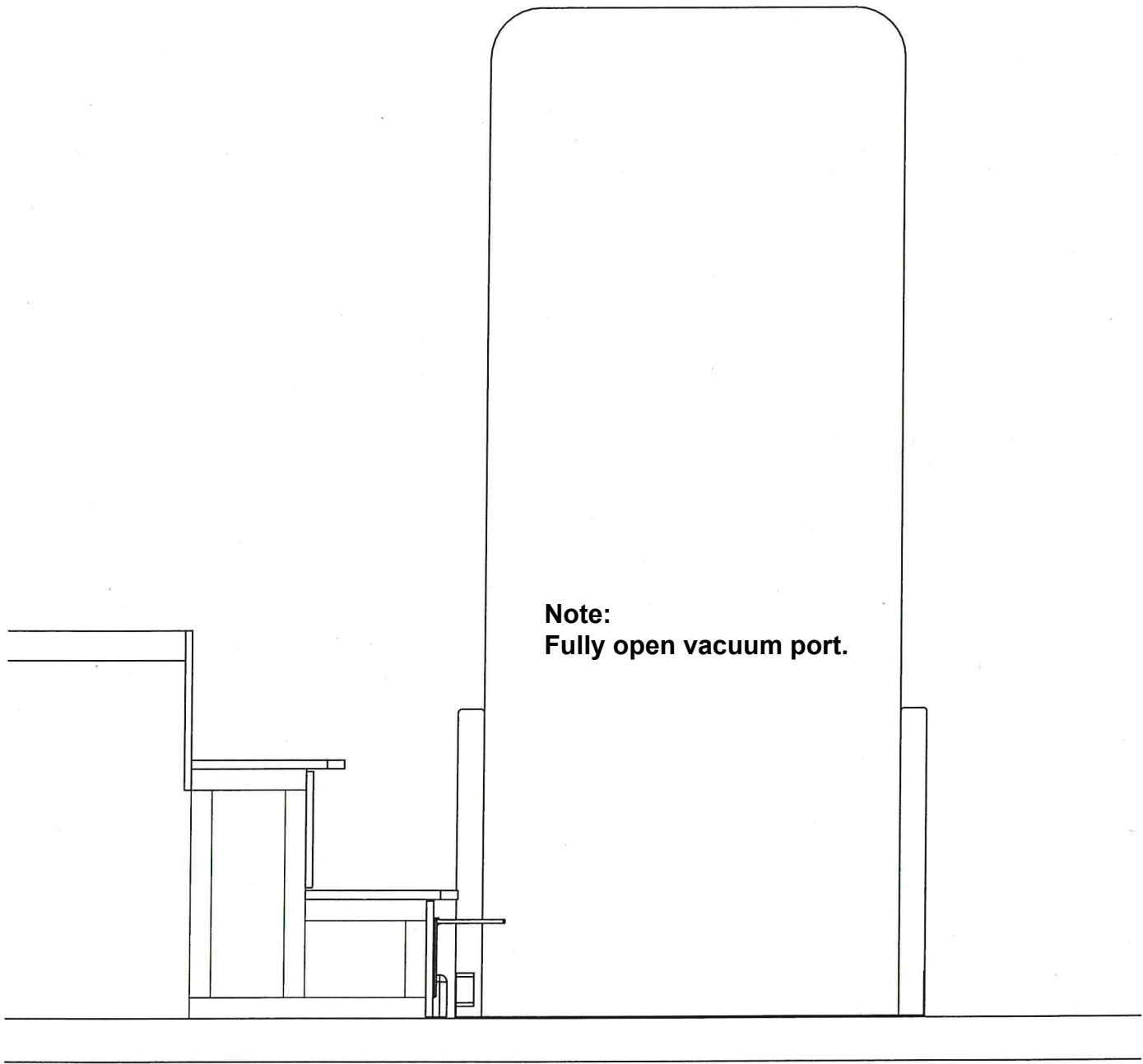

**Note:
Fully open vacuum port.**