



David J. Johnson
 Director
 Service Engineering Operations
 Ford Customer Service Division

Ford Motor Company
 P. O. Box 1904
 Dearborn, Michigan 48121

November 21, 2019

TO: All U.S. Ford and Lincoln Dealers

SUBJECT: **Customer Satisfaction Program 19B27 – Supplement #1**
 Certain 2019 Model Year F-Super Duty Vehicles
 Uncured Power Steering Hoses

New! REASON FOR THIS SUPPLEMENT

Labor Allowances: Unique labor operations have been established for the inspection of vehicles equipped with Vacuum Boost brakes vs. Hydro-Boost brakes.

PROGRAM TERMS

This program will be in effect through November 30, 2020. There is no mileage limit for this program.

URGENCY / EXPIRATION DATE

This Customer Satisfaction Program has an expiration date of November 30, 2020 to encourage dealers and customers to have this service performed as soon as possible.

We recommend dealers utilize their FSA VIN Lists name and address (available on December 2, 2019) to contact customers with affected vehicles. This will help minimize the number of vehicles that may experience a power steering fluid leak.

AFFECTED VEHICLES

Vehicle	Model Year	Assembly Plant	Build Dates
F-Super Duty	2019	Kentucky Truck	February 15, 2019 through June 14, 2019
		Ohio	February 15, 2019 through June 12, 2019

Affected vehicles are identified in OASIS and FSA VIN Lists.

REASON FOR THIS PROGRAM

In some of the affected vehicles, a power steering hose or hoses may not have been cured properly during the manufacturing process. An improperly cured power steering hose may develop a fluid leak and result in degradation or loss of the power steering assist. Vehicles with Hydro-Boost brake systems may also experience degradation or loss of the power brake assist.

SERVICE ACTION

Dealers are to inspect the lot batch and timestamp codes printed on affected power steering hoses, and replace if necessary. This service must be performed on all affected vehicles at no charge to the vehicle owner.

OWNER NOTIFICATION MAILING SCHEDULE

Owner letters were mailed the week of November 18, 2019. Dealers should repair any affected vehicles that arrive at their dealerships, whether or not the customer has received a letter.

ATTACHMENTS

Attachment I: Administrative Information
Attachment II: Labor Allowances and Parts Ordering Information
Attachment III: Technical Information
Owner Notification Letter

QUESTIONS & ASSISTANCE

For questions and assistance, contact the Special Service Support Center (SSSC) via the SSSC Web Contact Site. The SSSC Web Contact Site can be accessed through the Professional Technician Society (PTS) website using the SSSC link listed at the bottom of the OASIS VIN report screen or listed under the SSSC tab.

Sincerely,

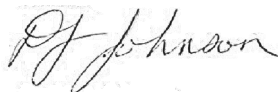
A handwritten signature in black ink that reads "D. Johnson". The signature is written in a cursive style with a large initial "D" and a long, sweeping underline.

David J. Johnson

Customer Satisfaction Program 19B27 – Supplement #1
Certain 2019 Model Year F-Super Duty Vehicles
Uncured Power Steering Hoses

OASIS ACTIVATION

OASIS was activated on November 4, 2019.

FSA VIN LISTS ACTIVATION

FSA VIN Lists have been available through <https://web.fsavinlists.dealerconnection.com> since November 4, 2019. Owner names and addresses will be available by December 2, 2019.

NOTE: Your FSA VIN Lists may contain owner names and addresses obtained from motor vehicle registration records. The use of such motor vehicle registration data for any purpose other than in connection with this program is a violation of law in several states, provinces, and countries. Accordingly, you must limit the use of this listing to the follow-up necessary to complete this service action.

SOLD VEHICLES

- Owners of affected vehicles will be directed to dealers for repairs.
- Immediately contact any of your affected customers whose vehicles are not on your VIN list but are identified in OASIS. Give the customer a copy of the Owner Notification Letter (when available) and schedule a service date.
- Correct other affected vehicles identified in OASIS which are brought to your dealership.
- Dealers are to prioritize repairs of customer vehicles over repairs of new and used vehicle inventory.

STOCK VEHICLES

- Correct all affected units in your new vehicle inventory before delivery.
- Use OASIS to identify any affected vehicles in your used vehicle inventory.

TITLE BRANDED / SALVAGED VEHICLES

Affected title branded and salvaged vehicles are eligible for this service action.

OWNER REFUNDS

Refunds are not approved for this program.

RENTAL VEHICLES

Rental vehicles are not approved for this program.

Customer Satisfaction Program 19B27 – Supplement #1
Certain 2019 Model Year F-Super Duty Vehicles
Uncured Power Steering Hoses

ADDITIONAL REPAIR (LABOR TIME AND/OR PARTS)

Additional repairs identified as necessary to complete the FSA should be managed as follows:

- For related damage and access time requirements, refer to the Warranty and Policy Manual / Section 6 – Ford & Lincoln Program Policies / General Information & Special Circumstances for FSA's / Related Damage.
- For vehicles within new vehicle bumper-to-bumper warranty coverage, no SSSC approval is required, although related damage must be on a separate repair line with the "Related Damage" radio button checked.
 - Ford vehicles – 3 years or 36,000 miles

CLAIMS PREPARATION AND SUBMISSION

- **Claim Entry:** Enter claims using Dealer Management System (DMS) or One Warranty Solution (OWS) online.
 - When entering claims, select claim type 31: Field Service Action. The FSA number 19B27 is the sub code.
 - For additional claims preparation and submission information, refer to the Recall and Customer Satisfaction Program (CSP) Repairs in the OWS User Guide.
- **Related Damage/Additional labor and/or parts:** Must be claimed as Related Damage on a separate repair line from the FSA with same claim type and sub code as described in Claim Entry above.

IMPORTANT: Click the Related Damage Indicator radio button.

Customer Satisfaction Program 19B27 – Supplement #1

Certain 2019 Model Year F-Super Duty Vehicles

Uncured Power Steering Hoses

New! LABOR ALLOWANCES

Description	Labor Operation	Labor Time
Inspection Passes		
Vacuum Boost - Inspect Power Steering Pump to Gear Hose - PASS	19B27A	0.3 Hours
Hydro-Boost - Inspect Power Steering Pump to Hydro-Boost and Hydro-Boost to Gear Hoses - PASS	19B27AA	0.4 Hours
Vehicles with Vacuum Boost Brakes – Inspection Does Not Pass*		
With 6.2L Engine – Replace Power Steering Pump to Gear Hose	19B27B	0.6 Hours
With 6.7L Engine – Replace Power Steering Pump to Gear Hose	19B27C	0.8 Hours
Vehicles with Hydro-Boost Brakes – Inspection Does Not Pass (all engines)		
Replace Power Steering Pump to Hydro-Boost Hose	19B27D	1.3 Hours
Replace Hydro-Boost to Gear Hose	19B27E	1.1 Hours
Replace Both the Power Steering Pump to Hydro-Boost Hose and the Hydro-Boost to Gear Hose	19B27F	1.6 Hours

NOTE: All labor operations include inspection time.

* There are no 6.8L vehicles with Vacuum Boost Brakes affected by this program.

Customer Satisfaction Program 19B27 – Supplement #1
Certain 2019 Model Year F-Super Duty Vehicles
Uncured Power Steering Hoses

PARTS REQUIREMENTS / ORDERING INFORMATION

Less than 5% of the affected vehicle population is expected to require a power steering hose replacement. Dealers must perform the power steering hose inspection prior to placing part orders.

To place an order submit a VIN-specific Part Order contact with a photo of the affected identification codes located on the power steering hose, via the SSSC Web Contact Site. Open part ordering for the part numbers listed BELOW is expected to begin by December 20, 2019.

Part Number	Description	Order Quantity	Claim Quantity
JC3Z-3A719-A	F-250-F-350 6.7L w/ Vacuum Boost w/ Active Steering (AFS) – Power Steering (P/S) Pump to Gear Hose	1	1
JC3Z-3A719-B	F-250-F-350 6.7L w/ Vacuum Boost w/o AFS – P/S Pump to Gear Hose	1	1
JC3Z-3A719-D	6.2L w/ Vacuum Boost - P/S Pump to Gear Hose	1	1
JC3Z-3A717-A	F-350-F550 6.7L w/ Hydro-Boost w/o AFS - P/S pump to Hydro-Boost Hose	1	1
JC3Z-3A717-B	F-350-F550 6.7L w/ Hydro-Boost, w/ AFS - P/S pump to Hydro-Boost Hose	1	1
JC3Z-3A717-C	6.2L & 6.8L w/ Hydro-Boost - P/S pump to Hydro-Boost Hose	1	1
JC3Z-3A719-E	F-250-F-350 – Hydro-Boost to P/S Gear Hose	1	1
JC3Z-3A719-C	F-450-F-550 – Hydro-Boost to P/S Gear Hose	1	1
XT5QMC	Transmission Fluid	As Required (if inspection does not pass)	

Dealers will be notified via a DOES II communication if circumstances warrant a change in part supply strategy and when open ordering resumes.

DEALER PRICE

For latest prices, refer to DOES II..

EXCESS STOCK RETURN

Excess stock returned for credit must have been purchased from Ford Customer Service Division in accordance with Policy Procedure Bulletin 4000.

CERTAIN 2019 MODEL YEAR F-SUPER DUTY VEHICLES — UNCURED POWER STEERING HOSES

OVERVIEW

In some of the affected vehicles, a power steering hose or hoses may not have been cured properly during the manufacturing process. An improperly cured power steering hose may develop a fluid leak and result in degradation or loss of the power steering assist. Vehicles with Hydro-Boost brake systems may also experience degradation or loss of the power brake assist.

Dealers are to inspect the lot batch and timestamp codes printed on affected power steering hoses, and replace if necessary. This service must be performed on all affected vehicles at no charge to the vehicle owner.

SERVICE PROCEDURE

1. Open the hood to determine if the vehicle is equipped with vacuum boost, or Hydro-Boost brake package. See Figure 1.
 - For vehicles equipped with Hydro-Boost - Proceed to Power Steering Fluid Pressure Hose Inspection - Vehicles Equipped with Hydro-Boost, on Page 2.
 - For vehicles equipped with Vacuum Boost - Proceed to Power Steering Pump to Steering Gear Pressure Hose Inspection - Vehicles Equipped with Vacuum Boost, on Page 17.

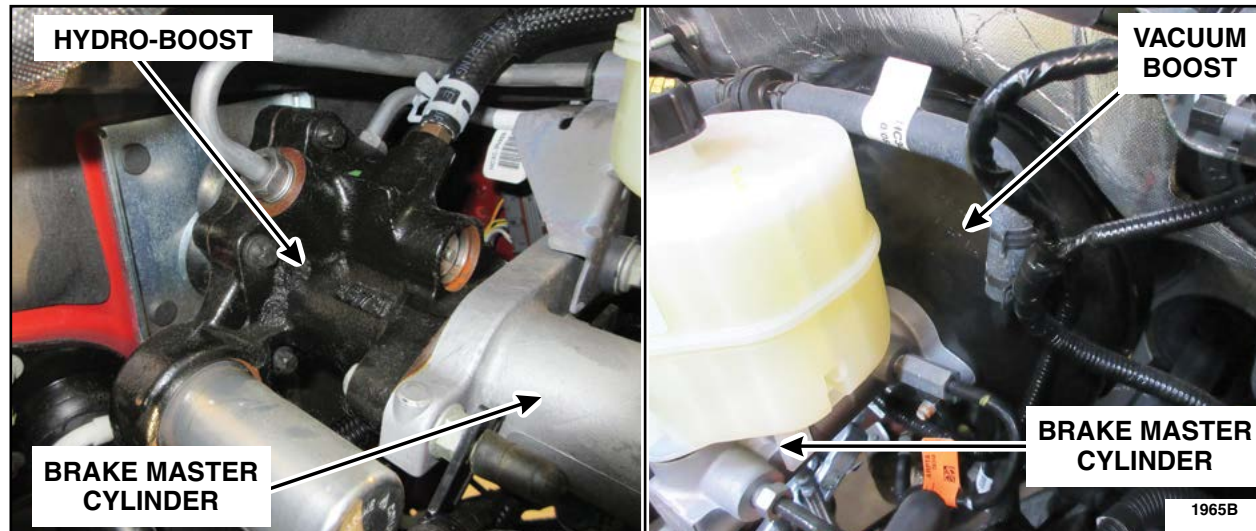

FIGURE 1



Power Steering Fluid Pressure Hose Inspection - Vehicles Equipped with Hydro-Boost

1. Release the two retainer clips for the left hand (LH) fuse box and position the fuse box aside. See Figure 2.

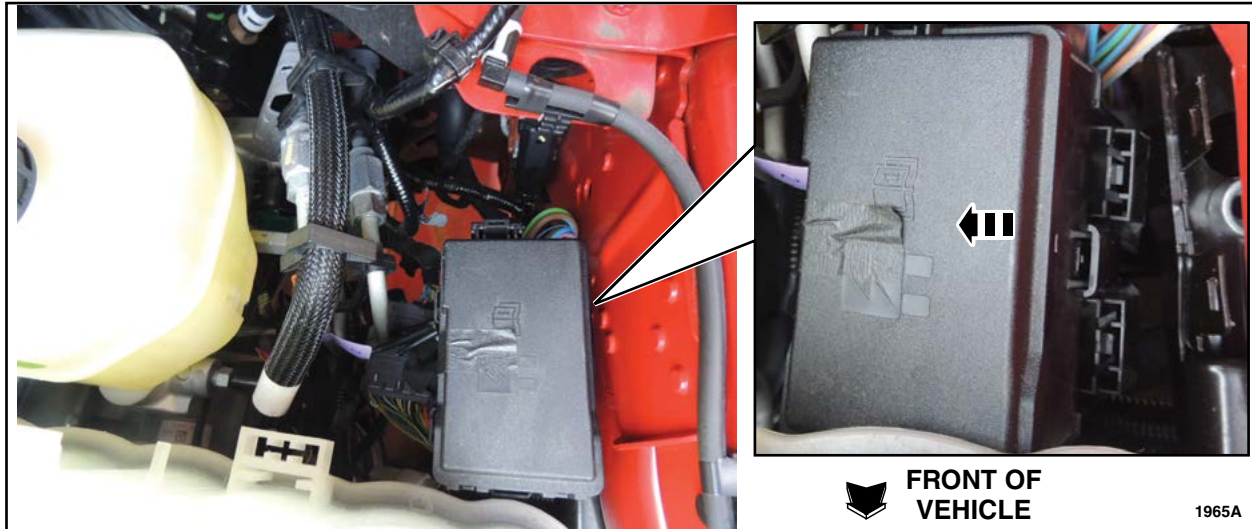

FIGURE 2

2. Remove the upper convolute from the power steering pump to Hydro-Booster and the Hydro-Booster to steering gear pressure hoses. See Figure 3.

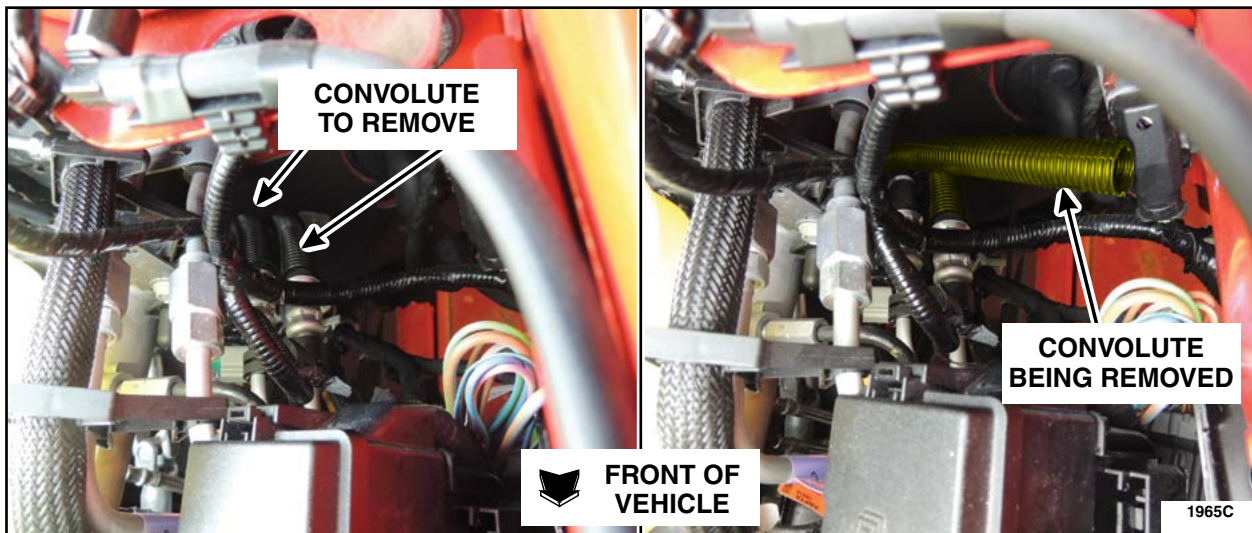

FIGURE 3



NOTE: The identification code repeats approximately every 10 inches on the power steering pressure hoses.

3. Locate and inspect the identification code on both power steering pressure hoses. See Figure 4.

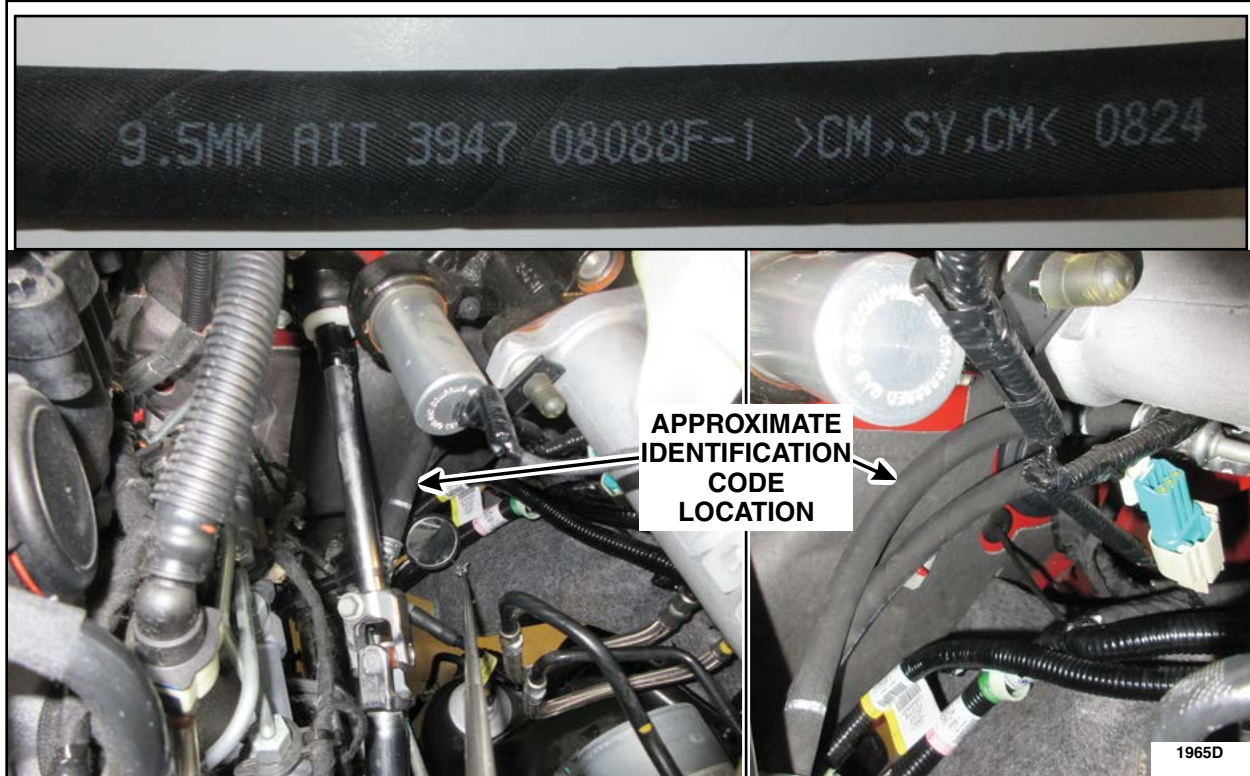

FIGURE 4

4. Position vehicle on a hoist. Please follow the Workshop Manual (WSM) procedures in Section 100-02.

5. Remove the lower convolute on the power steering pump to Hydro-Boost pressure hose. See Figure 5.

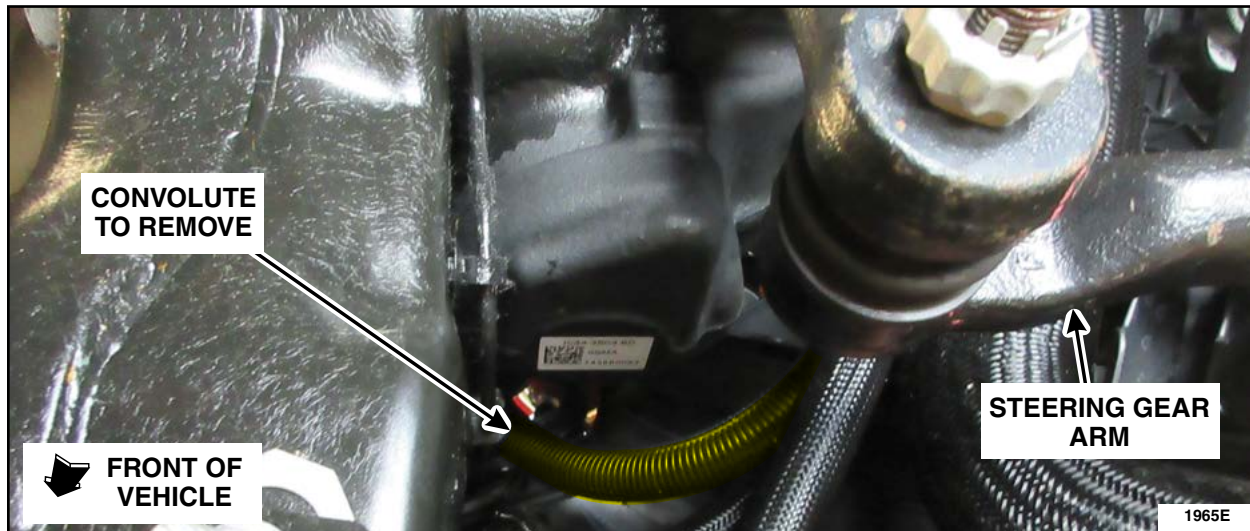

FIGURE 5



6. Locate and inspect the identification codes on the lower rubber section of the power steering pump to Hydro-Boost pressure hose. See Figure 6.



FIGURE 6

7. Is the code with 'F' at the end 01249F and is the second code equal to or between 1315-1340?

Yes - Replace the affected hose:

- For power steering pump to Hydro-Boost pressure hose. Proceed to Power Steering Pump to Hydro-Boost Pressure Hose Replacement, on Page 5.
- For Hydro-Boost to steering gear pressure hose. Proceed to Hydro-Boost to Steering Gear Pressure Hose Replacement, on Page 12.

No - Reinstall the convolute and reposition the fuse box by reversing the removal procedure.

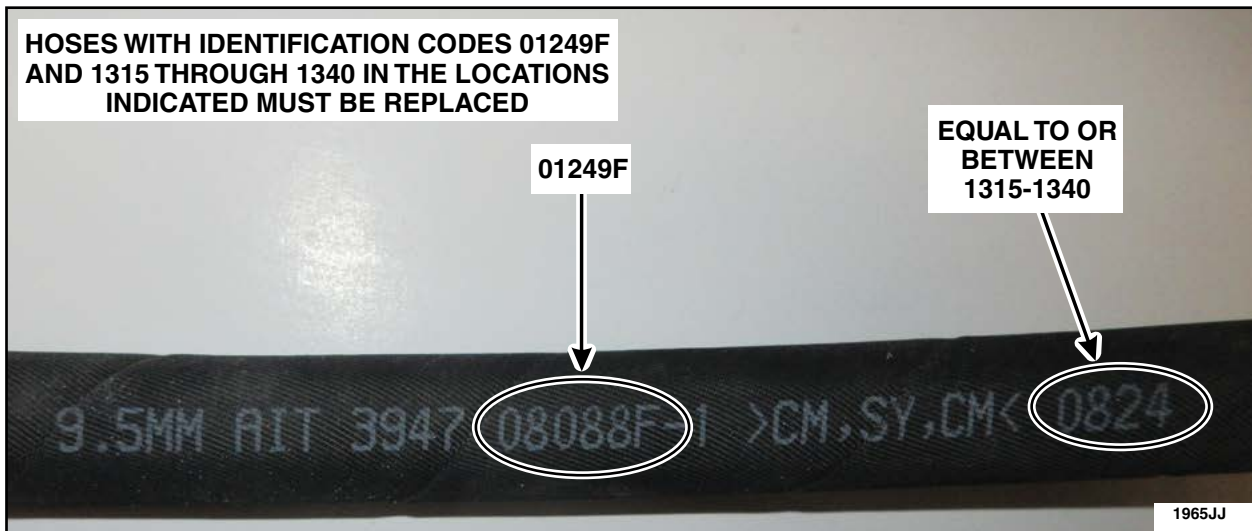

FIGURE 7



Power Steering Pump to Hydro-Boost Pressure Hose Replacement

1. Remove the power steering pump to Hydro-Boost pressure hose bracket retainer. See Figure 8.

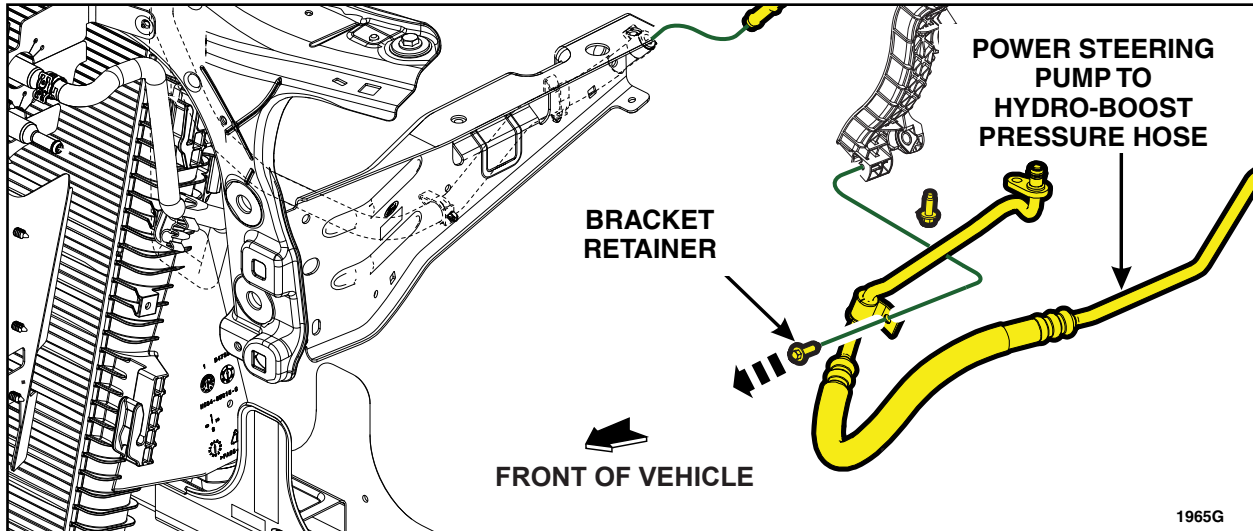

FIGURE 8

2. Remove the retainer and disconnect the power steering pump to Hydro-Boost pressure hose at the power steering pump. See Figure 9.

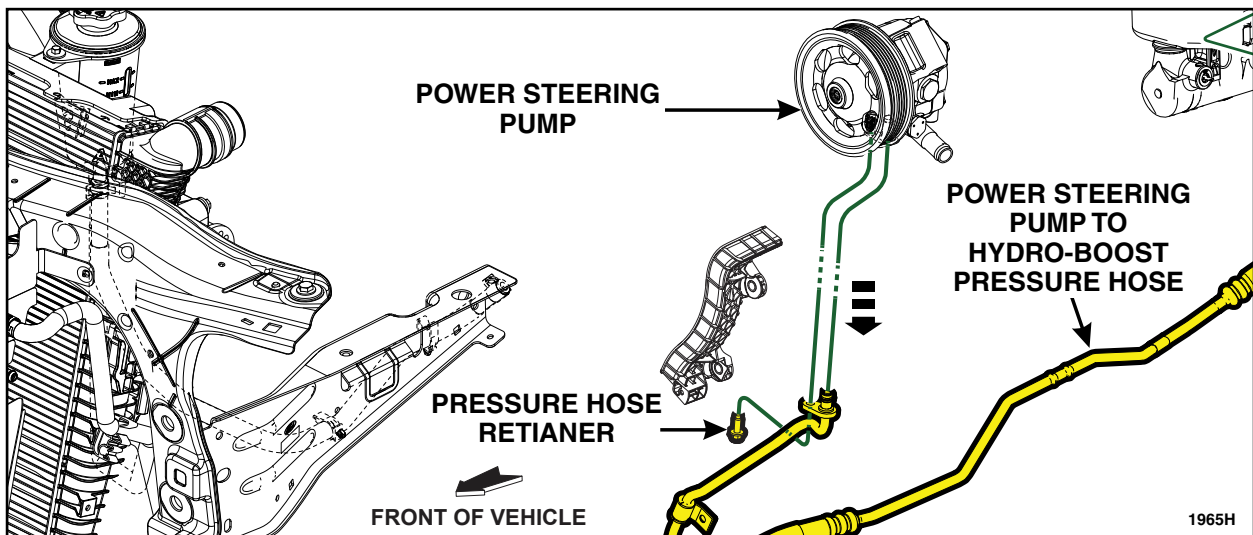

FIGURE 9



3. Remove the LH fender splash shield. Please follow the WSM procedures in Section 501-08.
4. Release the power steering pressure hose from the retaining clip on the inboard side of the strut tower. See Figure 10.

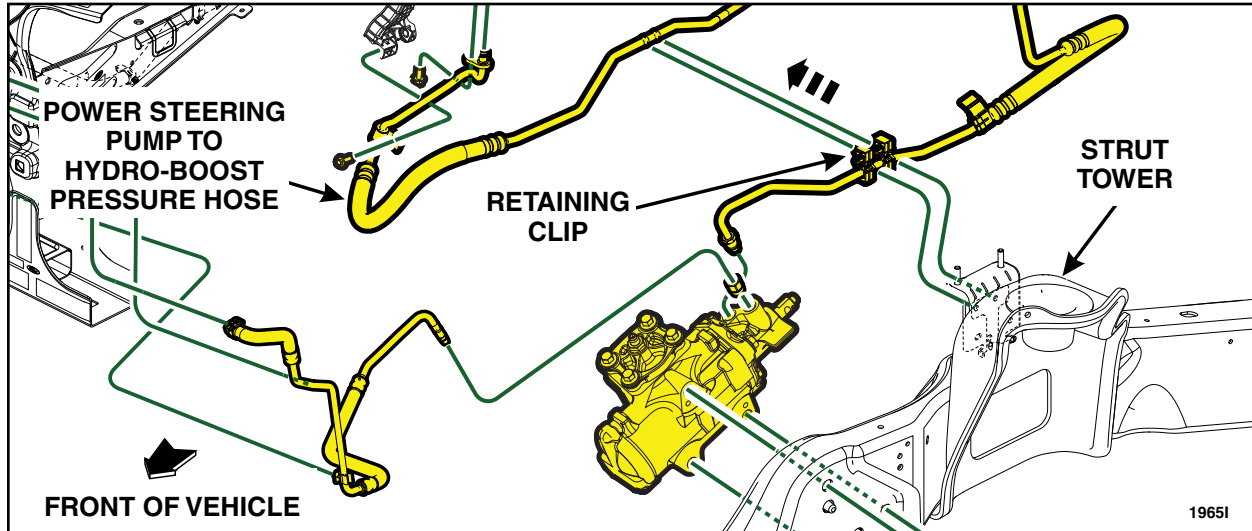

FIGURE 10

5. Remove the hose fitting from the Hydro-Boost junction and disconnect the power steering pump to Hydro-Boost pressure hose. See Figure 11.

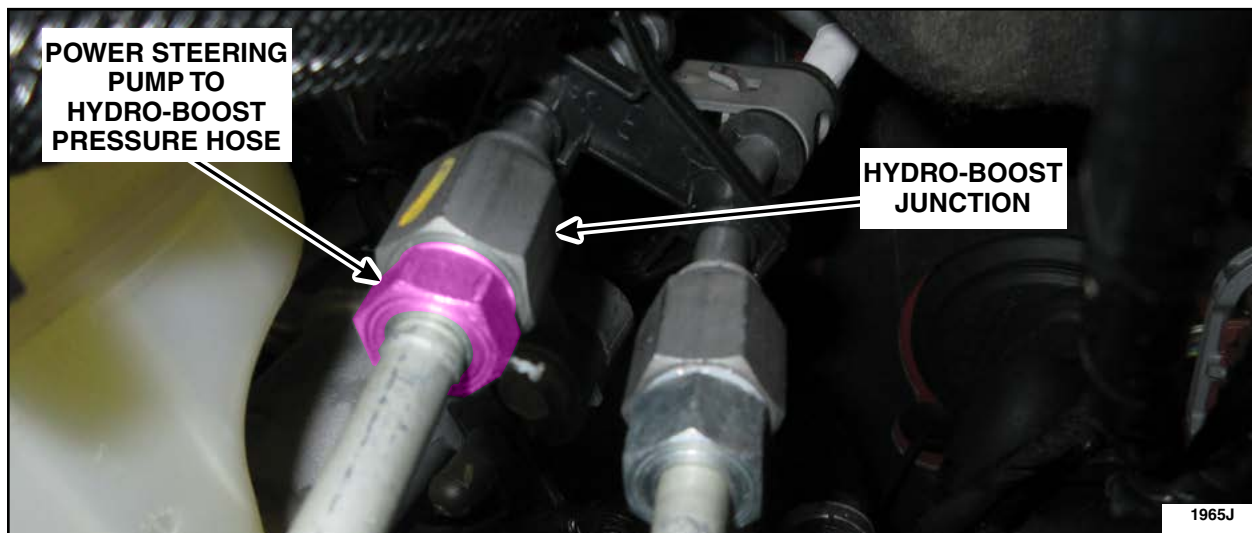

FIGURE 11



6. Working through the wheel well, remove and discard the power steering pump to Hydro-Boost pressure hose. See Figure 12.



FIGURE 12

7. Install the *new* pressure hose coupler into the Hydro-Boost junction. See Figure 13.

- Torque: 46 lb.ft (62 Nm)

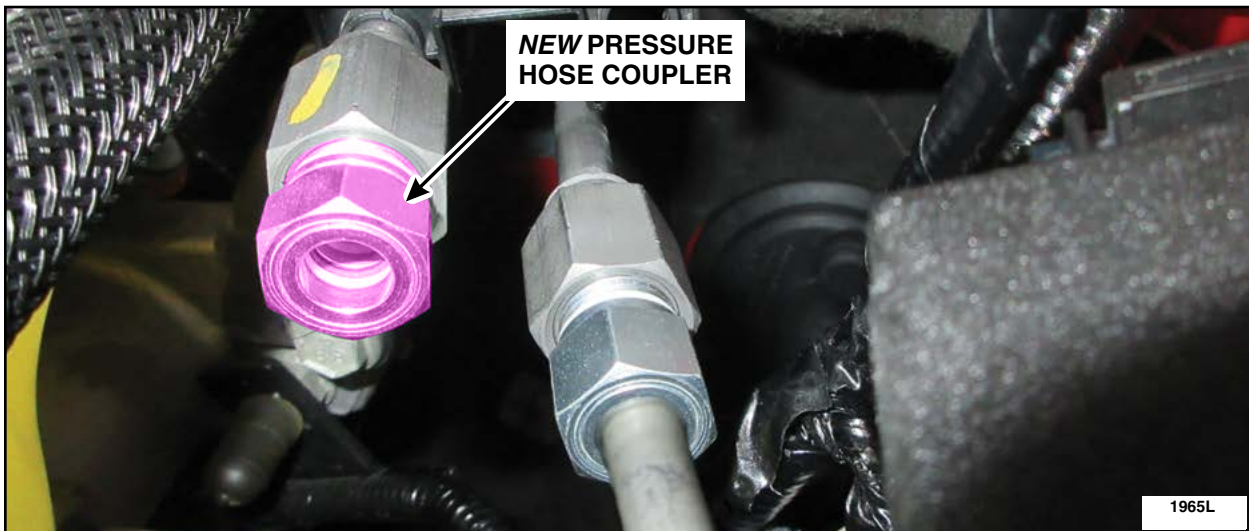

FIGURE 13



8. Working through the wheel well, route the *new* power steering pump to Hydro-Boost pressure hose upwards to the pressure hose coupler. See Figure 14.



FIGURE 14

9. Connect the *new* power steering pump to Hydro-Boost pressure hose to the coupler on the Hydro-Boost junction. See Figure 15.

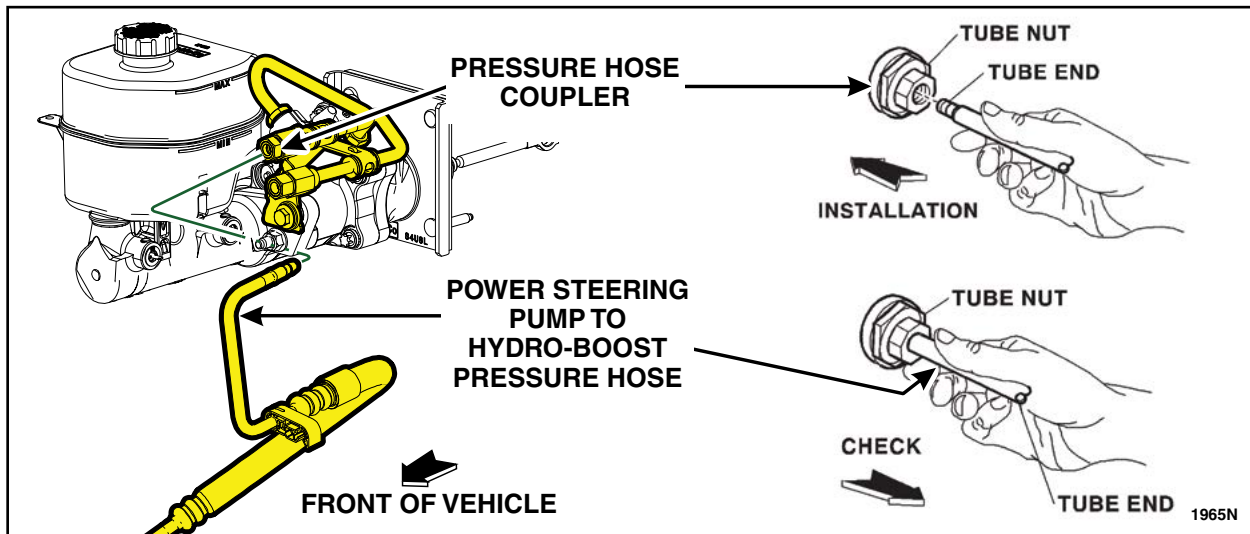

FIGURE 15



10. Connect the power steering pressure hose to the retaining clip on the inboard side of the strut tower.
See Figure 16.

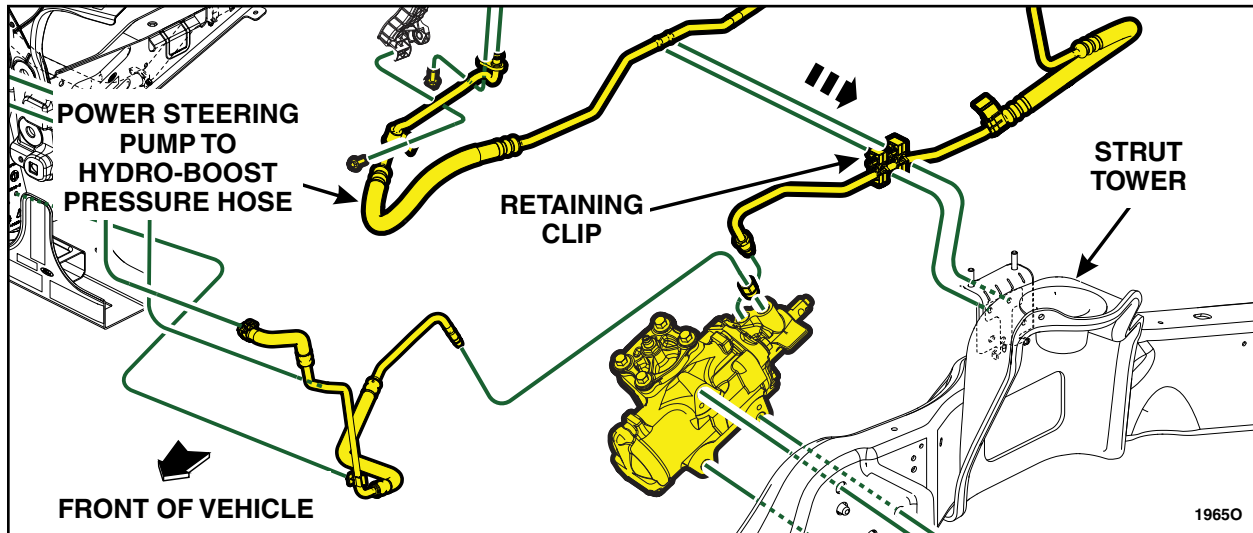

FIGURE 16

11. Connect the *new* power steering pump to Hydro-Boost pressure hose at the power steering pump and install the retainer. See Figure 17.

- Torque: 18 lb.ft (25 Nm)

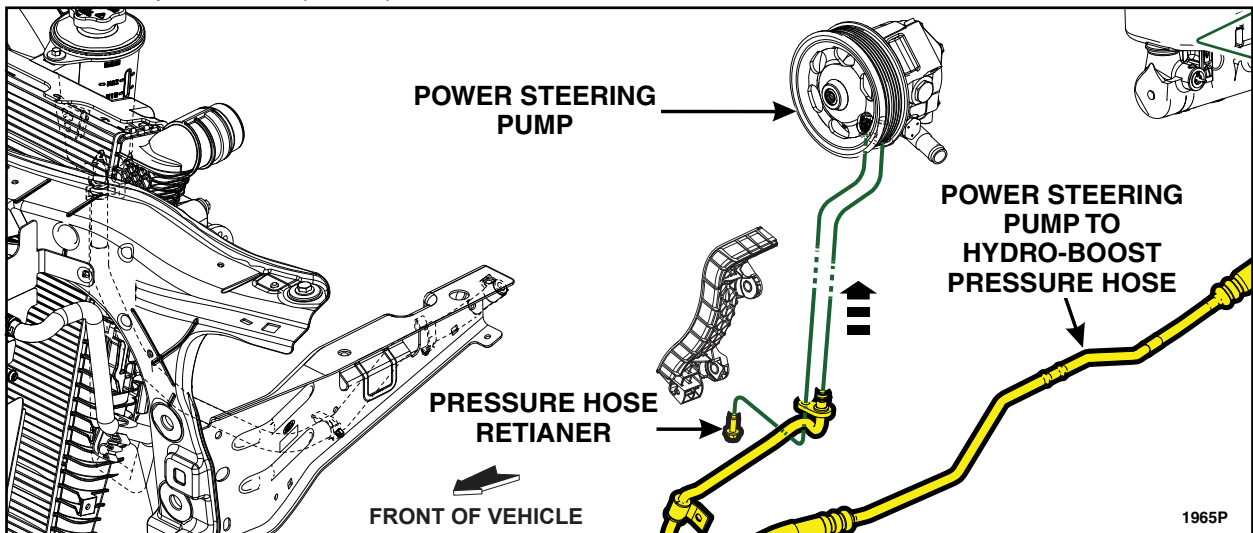

FIGURE 17



12. Install the power steering pump to Hydro-Boost pressure hose bracket retainer. See Figure 18.

- Torque: 48 lb.in (5.4 Nm)

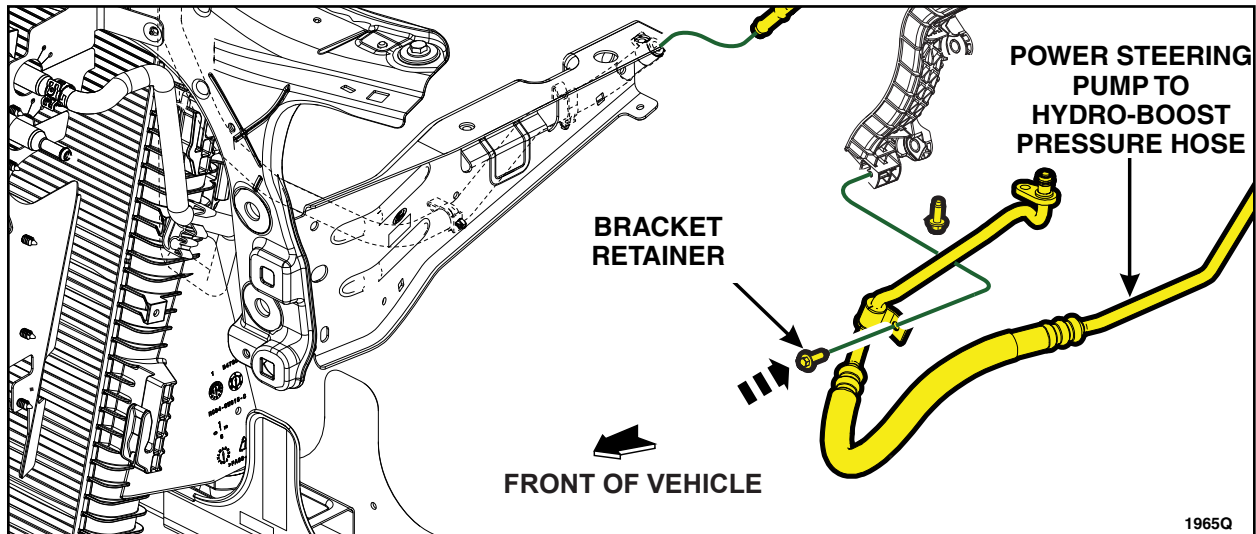

FIGURE 18

13. Install the convolute to the lower power steering pump to Hydro-Boost pressure hose. See Figure 19.

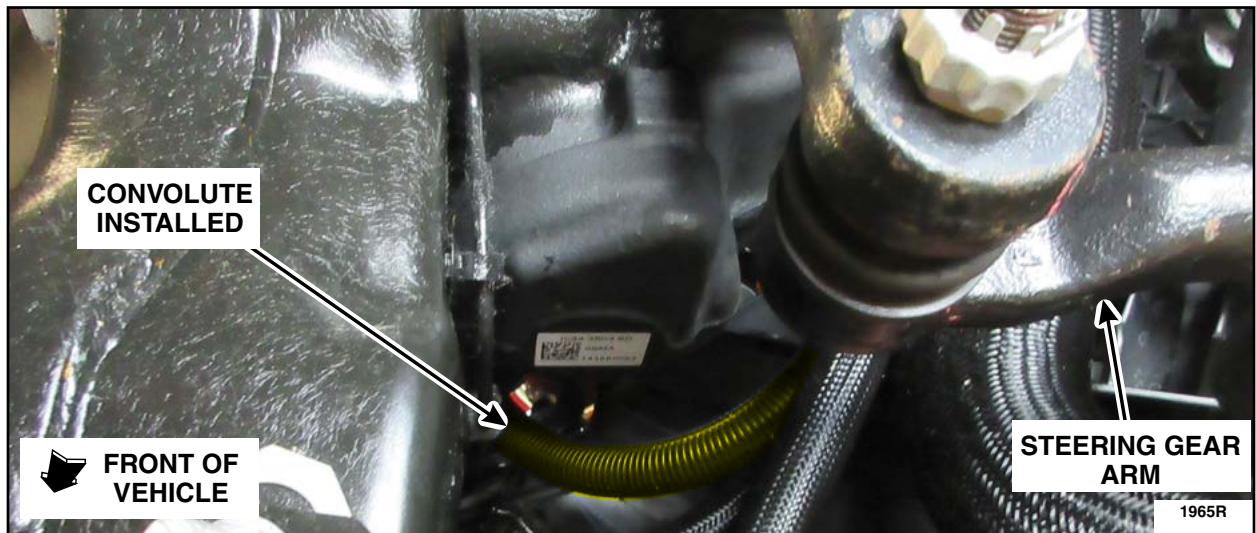

FIGURE 19



14. Install the convolute to the upper power steering pump to Hydro-Boost and Hydro-Boost to steering gear pressure hoses. See Figure 20.

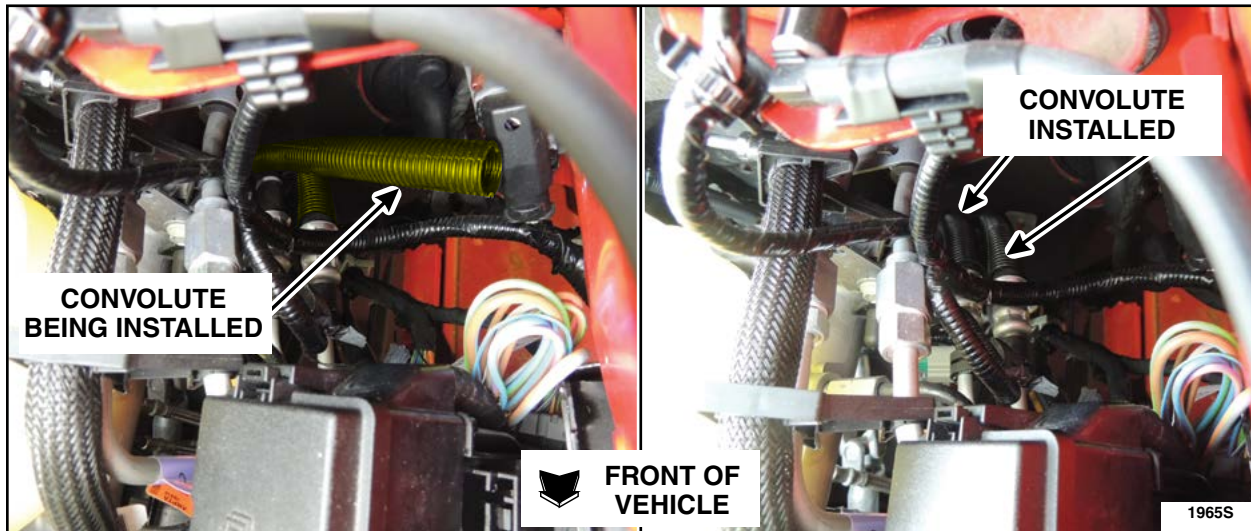

FIGURE 20

NOTE: If the Hydro-Boost to steering gear pressure hose is to be replaced, do not reassemble the vehicle or purge the power steering system at this time. Please refer to Page 12 Hydro-Boost to Steering Gear Pressure Hose Replacement.

15. Install the LH fender splash shield. Please follow the WSM procedures in Section 501-08.
16. Position back the LH side fuse box. See Figure 21.

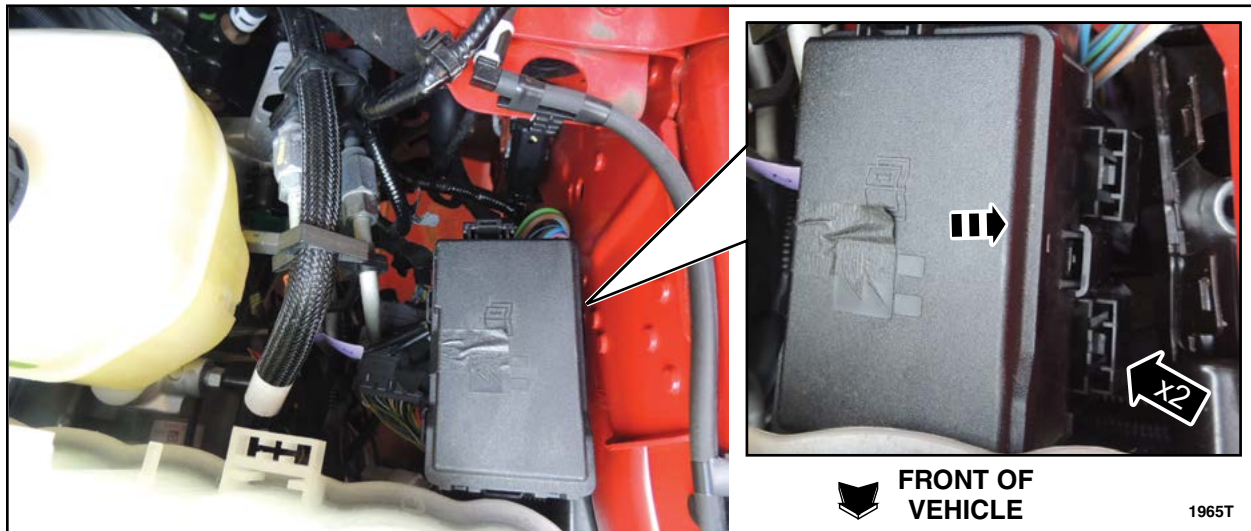

FIGURE 21

17. Purge the power steering system. Please follow the WSM procedures in Section 211-02.



Hydro-Boost to Steering Gear Pressure Hose Replacement

1. Remove the LH fender splash shield. Please follow WSM procedures in Section 501-08.
2. Remove the hose fitting from the steering gear and disconnect the Hydro-Boost to steering gear pressure hose. See Figure 22.

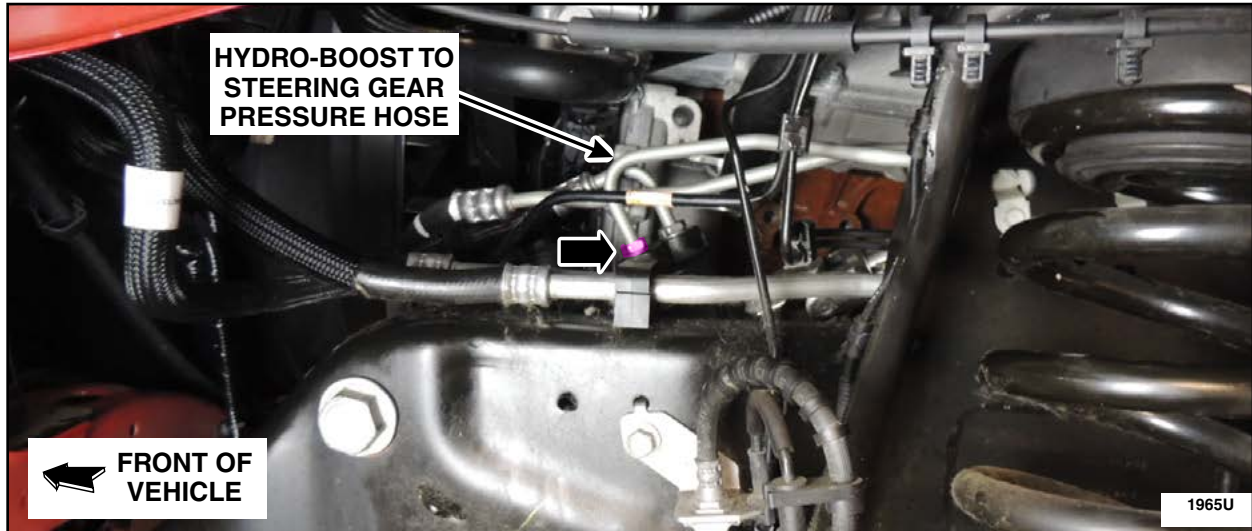

FIGURE 22

3. Release the retaining clip on the inboard strut tower and near the Hydro-Boost junction. See Figure 23.

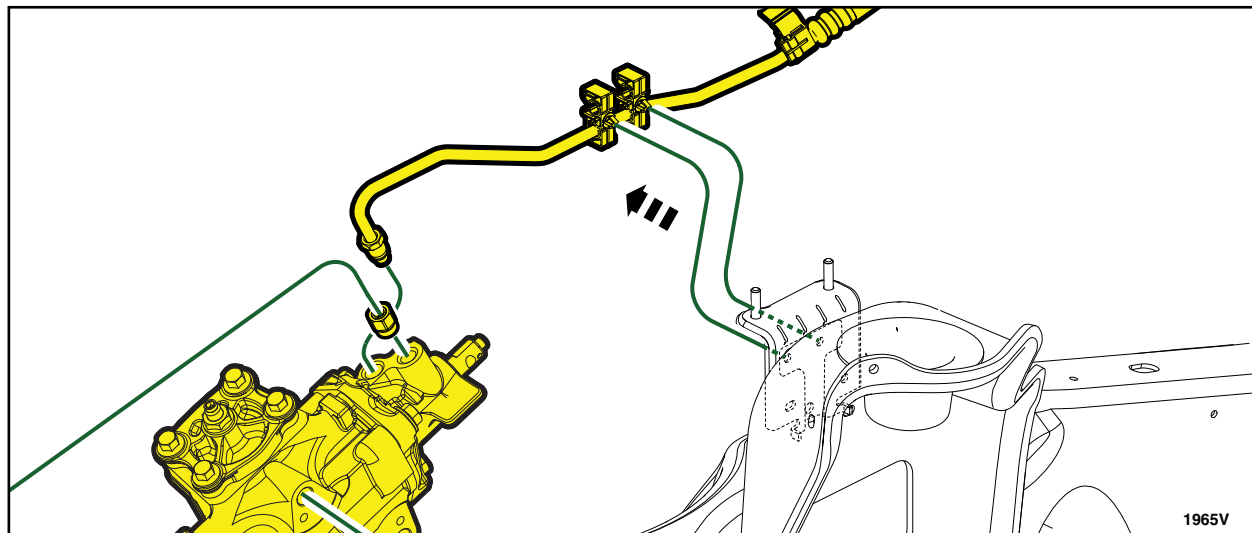

FIGURE 23



4. Remove the hose fitting from the Hydro-Boost junction and disconnect the Hydro-Boost to steering gear pressure hose. See Figure 24.

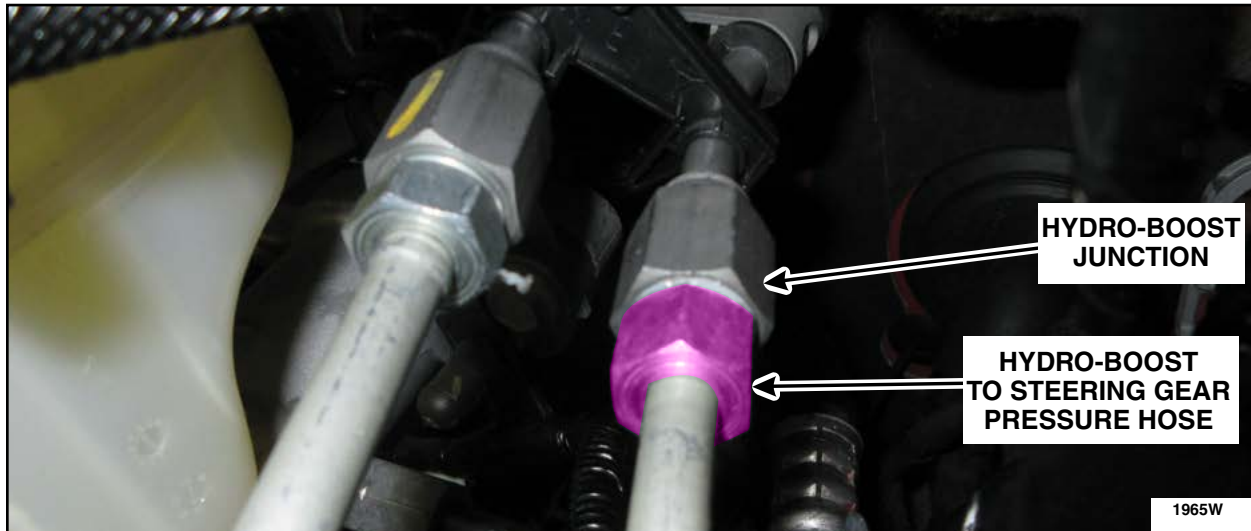

FIGURE 24

5. Working through the wheel well, remove and discard the Hydro-Boost to steering gear pressure hose. See Figure 25.



FIGURE 25



6. Install the *new* pressure hose coupler into the Hydro-Boost junction. See Figure 26.

- Torque: 46 lb.ft (62 Nm)

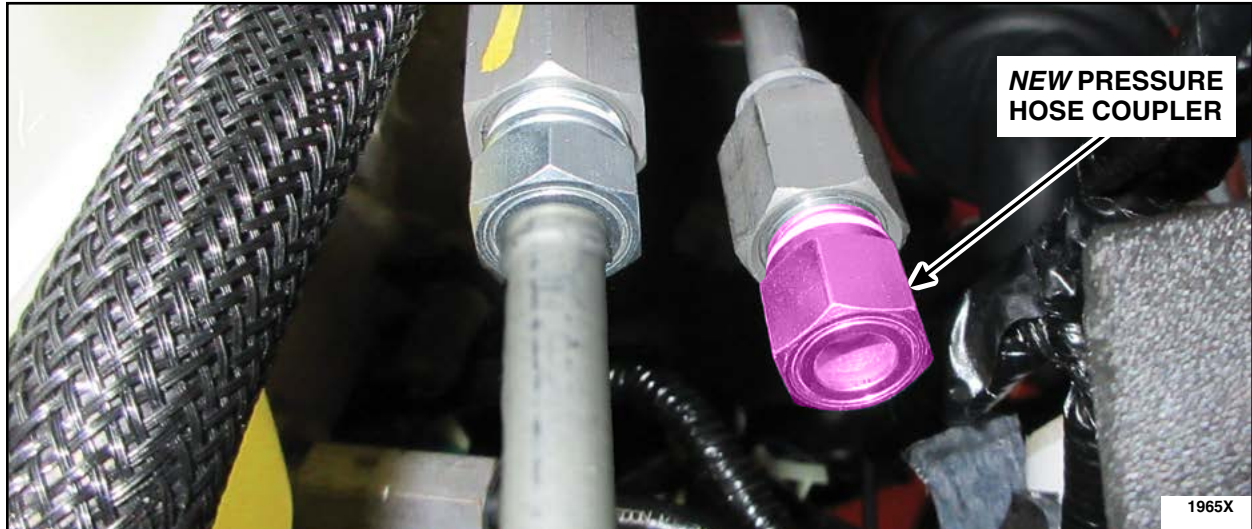

FIGURE 26

7. Working through the wheel well, route the *new* Hydro-Boost to steering gear pressure hose upwards to the pressure hose coupler. See Figure 27.



FIGURE 27



8. Install the *new* Hydro-Boost to steering gear pressure hose into the pressure hose coupler.
See Figure 28.

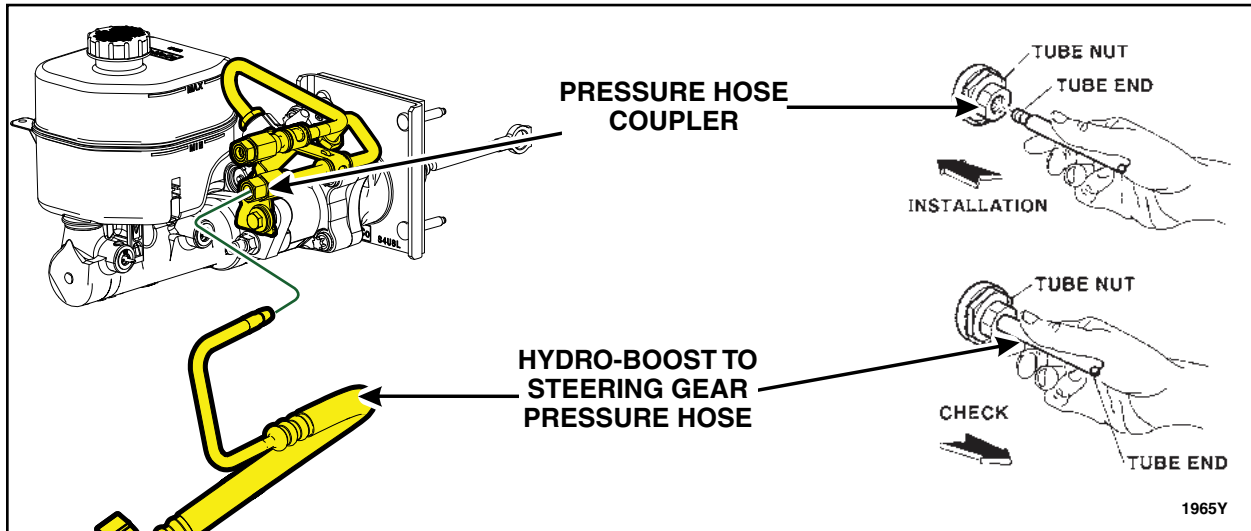

FIGURE 28

9. Connect the pressure hose retaining clip into the inboard strut tower. See Figure 29.

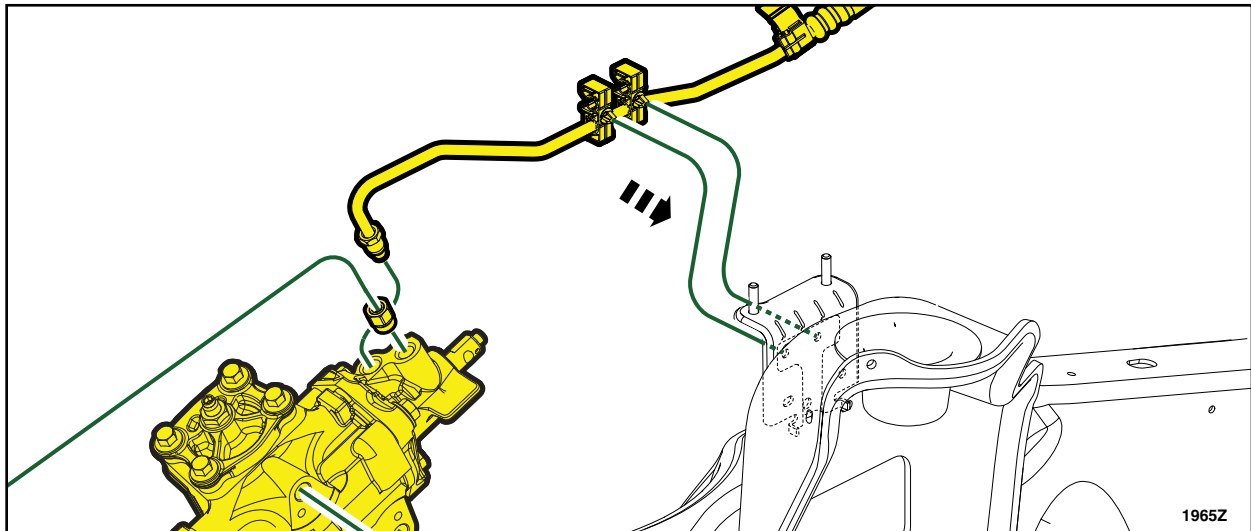

FIGURE 29



10. Connect the *new* Hydro-Boost to steering gear pressure hose at the steering gear. See Figure 30.

- Torque: 26 lb.ft (35 Nm)



FIGURE 30

11. Position back the LH side fuse box. See Figure 31.

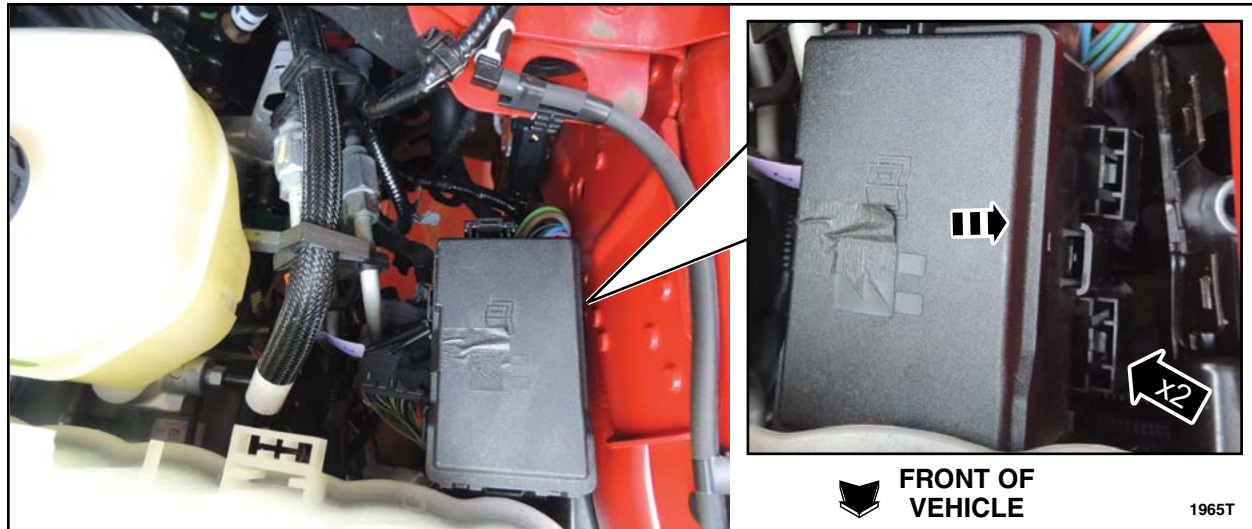

FIGURE 31

12. Install the LH fender splash shield. Please follow WSM procedures in Section 501-08.

13. Purge the power steering system. Please follow the WSM procedures in Section 211-02.



Power Steering Pump to Steering Gear Pressure Hose Inspection - Vehicles Equipped with Vacuum Boost

1. Remove the convolute from the power steering pump to steering gear pressure hose. See Figure 32.

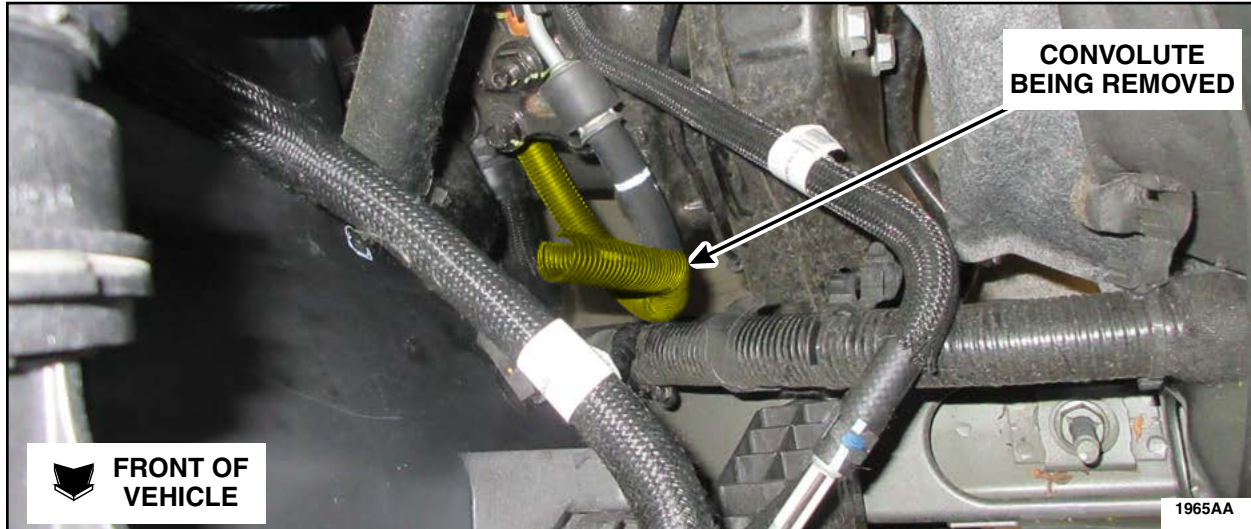

FIGURE 32

2. Inspect the identification code on the rubber section of the power steering pump to steering gear pressure hose. See Figure 33.



FIGURE 33



3. Compare the identification codes to the list shown below. Is the code with 'F' at the end 01249F and is the second code equal to or between 1315-1340? See Figure 34.

Yes - Proceed to Step 4.

No - Reinstall the convolute by reversing the removal procedure.



FIGURE 34

4. Remove the hose fitting from the power steering gear and disconnect the steering gear pressure hose. See Figure 35.

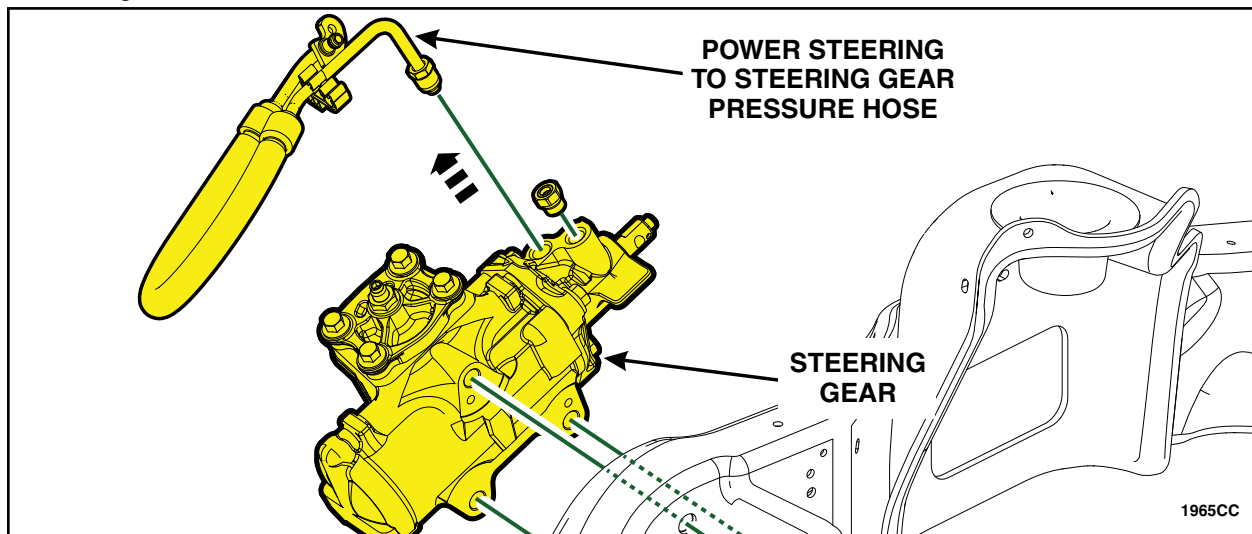

FIGURE 35



5. If equipped, remove the power steering pressure hose bracket retainer. See Figure 36.

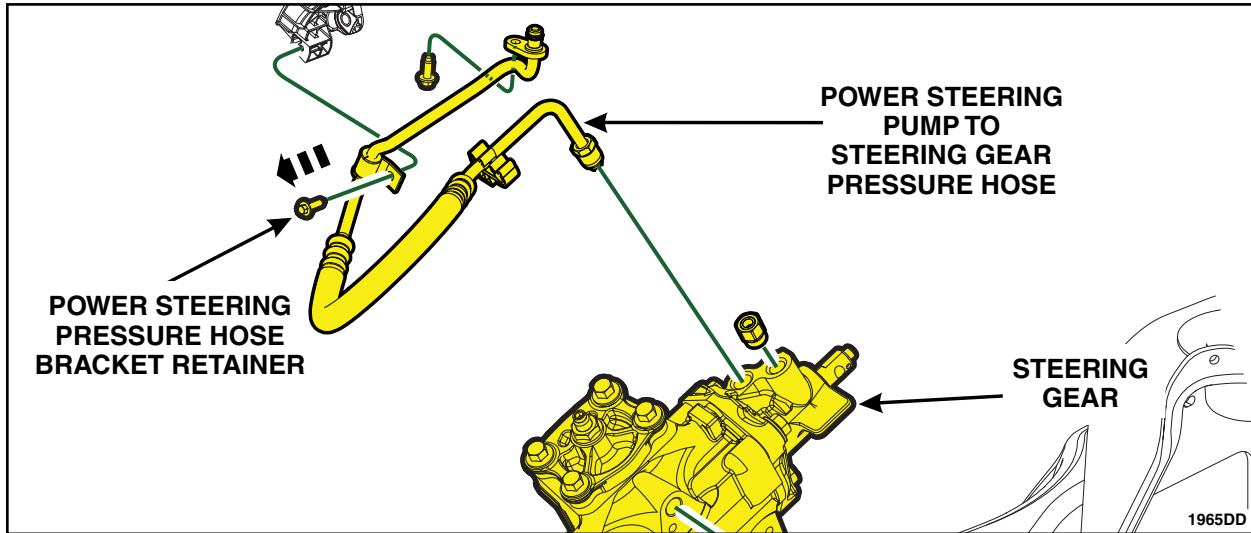

FIGURE 36

6. Position vehicle on a hoist. Please follow Workshop Manual (WSM) procedures in Section 100-02.

7. Remove the power steering pressure hose retainer at the power steering pump and discard the power steering pressure hose. See Figure 37.

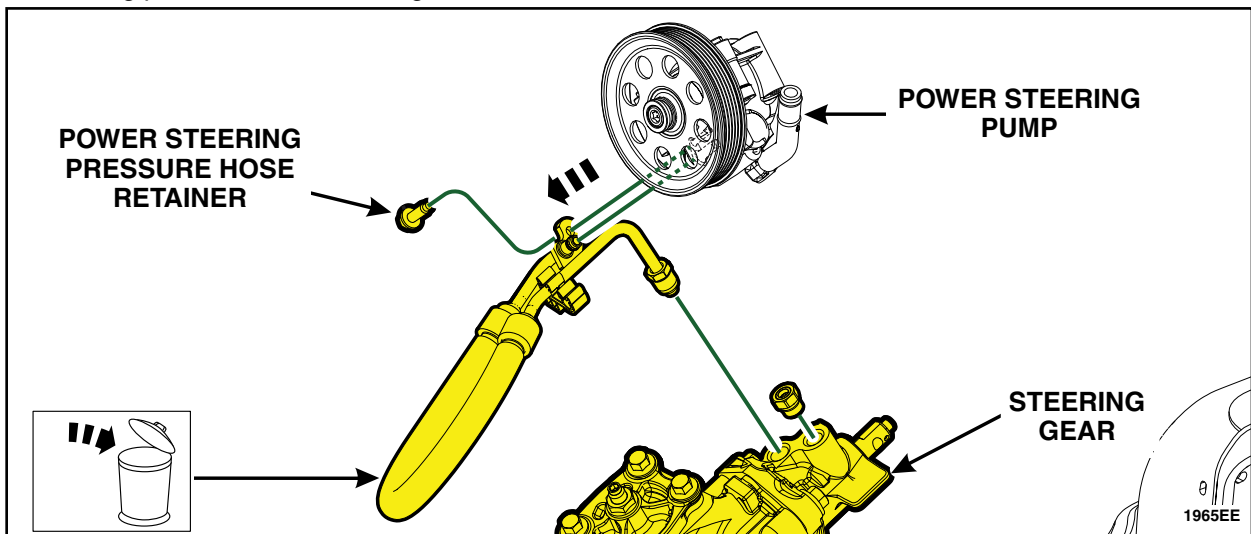

FIGURE 37



8. Install the *new* power steering pressure hose and the retainer at the power steering pump.
See Figure 38.

- Torque: 18 lb.ft (25 Nm)

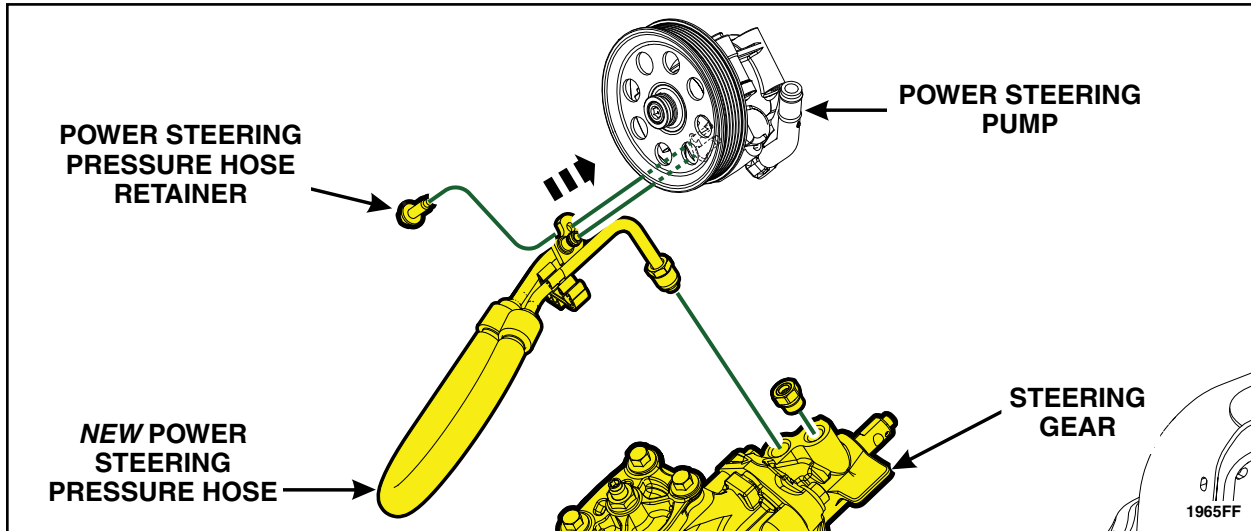

FIGURE 38

9. If equipped, install the power steering pressure hose bracket retainer. See Figure 39.

- Torque: 48 lb.ft (5.4 Nm)

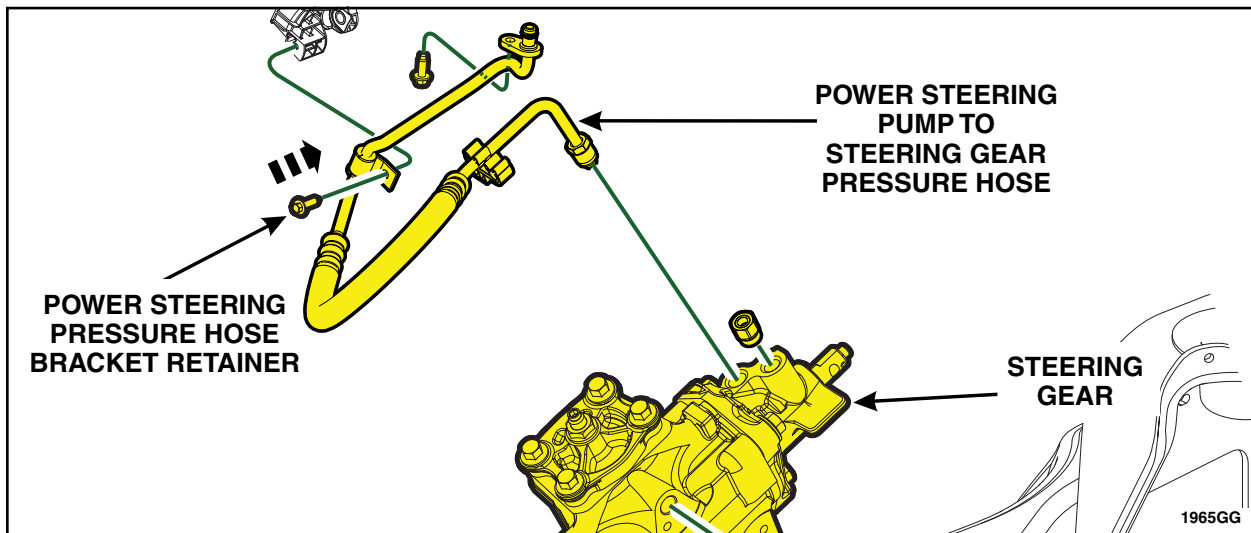

FIGURE 39



10. Connect the *new* power steering pressure hose at the steering gear. See Figure 40.

- Torque: 26 lb.ft (35 Nm)

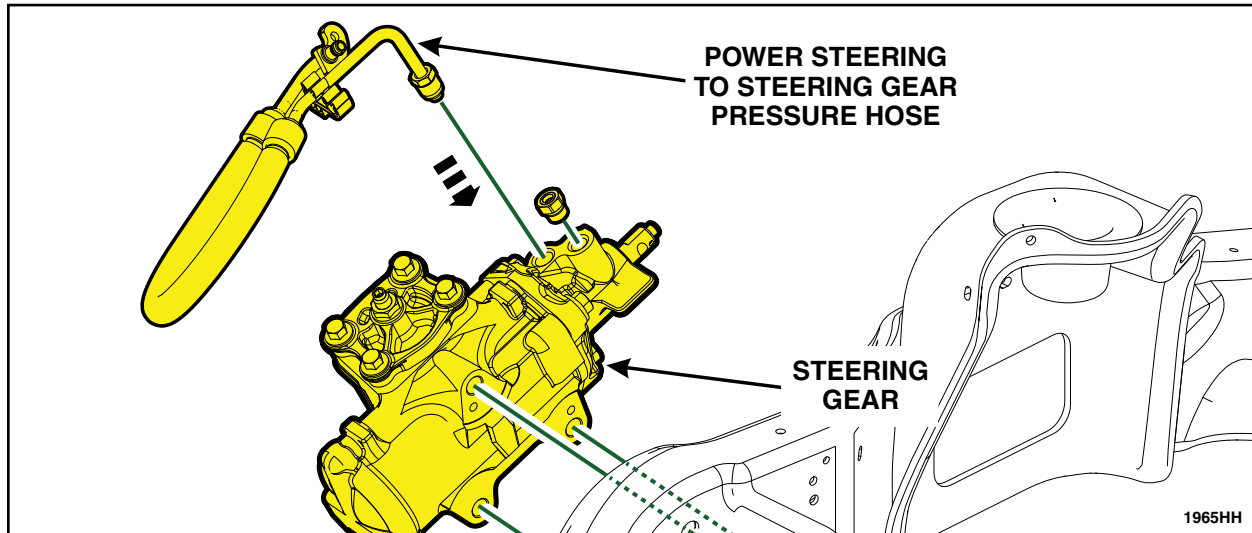

FIGURE 40

11. Install the convolute onto the power steering pressure hose. See Figure 41.

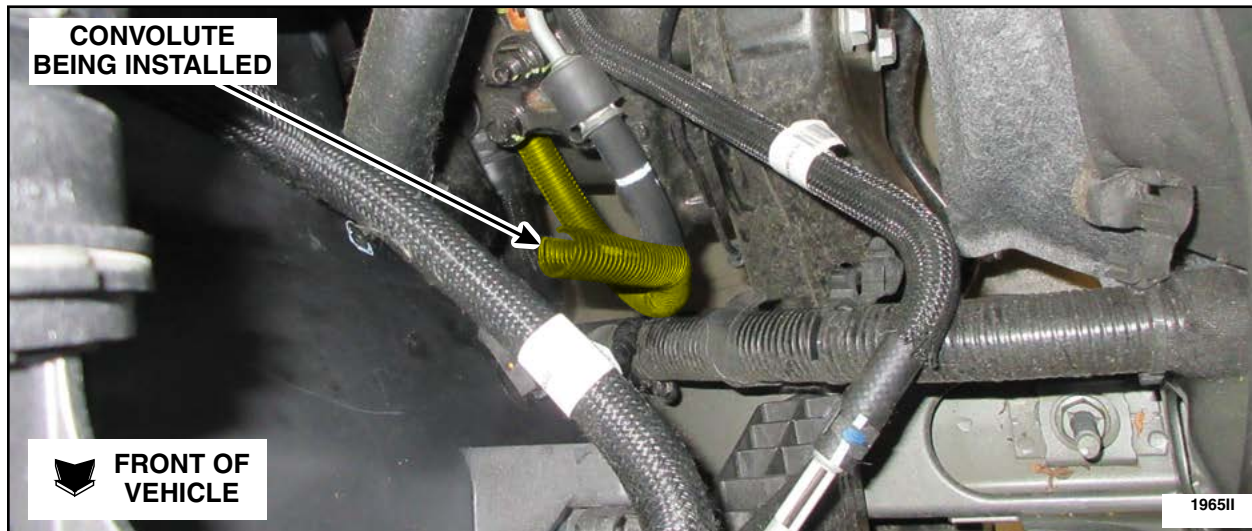

FIGURE 41

12. Purge the power steering system. Please follow WSM procedures in Section 501-08.

