



Service Action Code: 1903

REVISION

Subject Coolant Bottle

Release Date October 16, 2019

REVISION SUMMARY Updated claiming instructions

Affected Vehicles

Country	Model Year(s)	Vehicle
USA	2018	TIGUAN LWB
USA	2019	JETTA NF
CAN	2018	TIGUAN LWB
CAN	2019	JETTA NF

Check Campaigns/Actions screen in Elsa on the day of repair to verify that a VIN qualifies for repair under this action. Elsa is the only valid campaign inquiry & verification source.

- ✓ Campaign status must show "open."
- ✓ If Elsa shows other open action(s), inform your customer so that the work can also be completed at the same time the vehicle is in the workshop for this campaign.

Problem Description The coolant bottle may leak coolant into the electrical connector for the coolant level sensor.

Corrective Action Inspect and, if necessary, replace the coolant bottle.

Parts Information Expected coolant bottle replacement rate: Approximately 50%

Parts Control Type: Upper Order Limit	Parts will be managed with a weekly Upper Order Limit. Please see Parts On Command (POC) for your Upper Order Limit quantity.
--	---

Initial Allocation: YES	Dealers will be sent an initial allocation prior to customer notification. If no initial allocation was received, please reference the Repair Projection Tool (below) to view your potential VIN population.
--	--

Criteria	Part Number	Description	Qty. per Vehicle	Ordering Method
02	5QM-121-407-C	Tank	1	UOL
07	5QM-121-407-B	Tank	1	UOL

Repair Projection Tool (right click to open):

Code Visibility On or about October 15, 2019, affected vehicles were listed on the Inventory Vehicle Open Campaign Action report under My Dealership Reports (found on www.vw.com & OMD Web). A list was not posted for dealers who did not have any affected vehicles.

On or about October 15, 2019, this campaign code showed open on affected vehicles in Elsa.

On or about October 15, 2019, affected vehicles were identified with this campaign code in the VIN Lookup tool at www.vw.com.

The repair information in this document is intended for use only by skilled technicians who have the proper tools, equipment and training to correctly and safely maintain your vehicle. These procedures are not intended to be attempted by "do-it-yourselfers," and you should not assume this document applies to your vehicle, or that your vehicle has the condition described. To determine whether this information applies, contact an authorized Volkswagen dealer. ©2019 Volkswagen Group of America, Inc. and Volkswagen Canada. All Rights Reserved.

Owner Notification	Owner notification will take place in October 2019. Owner letter examples are included in this bulletin for your reference.
Campaign Expiration Date	This campaign expires on December 31, 2022 . Repairs must be performed on or before this date to be eligible for payment. Keep this expiration date in mind when scheduling customers for this action. If a customer wishes to have this service performed after the expiration date, your dealerships normal parts and labor cost associated with this repair will apply.
Additional Information	<p>Please alert everyone in your dealership about this action, including Sales, Service, Parts and Accounting personnel. Contact Warranty if you have any questions.</p> <p>Dealers must ensure that every affected inventory vehicle has this campaign completed <u>before delivery to consumers</u>.</p> <p>Fill out and affix Campaign Completion Label (CAMP 010 000) after work is complete. <i>Labels can be ordered at no cost via the Compliance Label Ordering portal at www.vwhub.com.</i></p>

Claim Entry Instructions

The labor times listed here may differ from the labor operations and labor times listed in ELSA.

After campaign has been completed, enter claim as soon as possible to help prevent work from being duplicated elsewhere. Attach the Elsa screen print showing action open on the day of repair to the repair order.

If customer refused campaign work:

- ✓ U.S. dealers: Submit request via WISE under the *Campaigns/Update/Recall Closure* option.
- ✓ Canada dealers: Upload the repair order [signed by customer] to Volkswagen WIN/Operations/Campaign Closure.

Service Number	1903 (Letter "o" not number zero)						
Damage Code	0099						
Parts Vendor Code	WWO						
Claim Type	Sold vehicle: 7 10 Unsold vehicle: 7 90						
Causal Indicator	Mark coolant tank as causal part* if replaced; otherwise select labor as causal						
Vehicle Wash/Loaner	Do not claim wash/loaner under this action U.S.A.: Loaner/rental coverage cannot be claimed under this action. However, loaner/rental may be covered under the mobility program. Please refer to section 3.30 in the Volkswagen Warranty Policy and Procedures Manual for loaner claims information and reimbursement details. Canada: Loaner/rental coverage cannot be claimed under this action. Please refer to Volkswagen Service Loaner Program to determine loaner eligibility.						
Criteria I.D.	02						
	<p>Inspect coolant tank; no coolant migration found</p> <p>Labor operation: 0183 00 99 20 T.U.</p> <p>-OR-</p> <p>Inspect coolant tank, -J519- (BCM) and ambient temperature sensor:</p> <ul style="list-style-type: none"> • Coolant tank requires <u>replacement</u> • -J519- (BCM) requires cleaning (if necessary) • Ambient temperature sensor requires cleaning (if necessary) <p>Labor operation: 1940 55 99 90 T.U.</p> <table border="1"> <thead> <tr> <th>Quantity</th> <th>Part Number</th> <th>Description</th> </tr> </thead> <tbody> <tr> <td>1.00</td> <td>5QM121407C</td> <td>Coolant Tank*</td> </tr> </tbody> </table> <p>-OR- (Continued on next page)</p>	Quantity	Part Number	Description	1.00	5QM121407C	Coolant Tank*
Quantity	Part Number	Description					
1.00	5QM121407C	Coolant Tank*					

Inspect coolant tank, -J519- (BCM) and ambient temperature sensor:

- Coolant tank requires replacement
- -J519- (BCM) requires cleaning (if necessary)
- Ambient temperature sensor requires replacement

Labor operation: 1940 56 99 90 T.U.

Quantity	Part Number	Description
1.00	5QM121407C	Coolant tank*
1.00	8Z0820535A	Ambient temperature sensor

-OR-

Inspect coolant tank, -J519- (BCM) and ambient temperature sensor:

- Coolant tank requires replacement
- -J519- (BCM) requires replacement
- Ambient temperature sensor requires cleaning (if necessary)

Labor operation: 1940 54 99 120 T.U.

Quantity	Part Number	Description
1.00	5QM121407C	Coolant Tank*
1.00	5Q0937087**	See ETKA - Central electronics control module (-J519-)

-AND-

Program new -J519- (BCM)

Labor operation: 9710 25 99 Time stated on diagnostic protocol
(Max 50 T.U.)

-OR-

Inspect coolant tank, -J519- (BCM) and ambient temperature sensor:

- Coolant tank requires replacement
- -J519- (BCM) requires replacement
- Ambient temperature sensor requires replacement

Labor operation: 1940 57 99 120 T.U.

Quantity	Part Number	Description
1.00	5QM121407C	Coolant Tank*
1.00	5Q0937087**	See ETKA - Central electronics control module (-J519-)
1.00	8Z0820535A	Ambient temperature sensor

-AND-

Program new -J519- (BCM)

Labor operation: 9710 25 99 Time stated on diagnostic protocol
(Max 50 T.U.)

Continued on next page

Criteria I.D.	07															
	<p>Inspect coolant tank; no coolant migration found Labor operation: 0183 00 99 20 T.U.</p> <p>-OR-</p> <p>Inspect coolant tank and -J519- (BCM):</p> <ul style="list-style-type: none"> • Coolant tank requires replacement, • -J519- (BCM) requires cleaning (if necessary) <p>Labor operation: 1940 58 99 110 T.U.</p> <table border="1"> <thead> <tr> <th>Quantity</th> <th>Part Number</th> <th>Description</th> </tr> </thead> <tbody> <tr> <td>1.00</td> <td>5QM121407B</td> <td>Coolant Tank*</td> </tr> </tbody> </table> <p>-OR-</p> <p>Inspect coolant bottle and -J519- (BCM):</p> <ul style="list-style-type: none"> • Coolant tank requires <u>replacement</u>, • -J519- (BCM) requires <u>replacement</u> <p>Labor operation: 1940 59 99 140 T.U.</p> <table border="1"> <thead> <tr> <th>Quantity</th> <th>Part Number</th> <th>Description</th> </tr> </thead> <tbody> <tr> <td>1.00</td> <td>5QM121407B</td> <td>Coolant Tank*</td> </tr> <tr> <td>1.00</td> <td>5Q0937087**</td> <td>See ETKA - Central electronics control module (-J519-)</td> </tr> </tbody> </table> <p>-AND-</p> <p>Program new -J519- (BCM)</p> <p>Labor operation: 9710 25 99 Time stated on diagnostic protocol (Max 50 T.U.)</p>	Quantity	Part Number	Description	1.00	5QM121407B	Coolant Tank*	Quantity	Part Number	Description	1.00	5QM121407B	Coolant Tank*	1.00	5Q0937087**	See ETKA - Central electronics control module (-J519-)
Quantity	Part Number	Description														
1.00	5QM121407B	Coolant Tank*														
Quantity	Part Number	Description														
1.00	5QM121407B	Coolant Tank*														
1.00	5Q0937087**	See ETKA - Central electronics control module (-J519-)														

Customer Letter Example (USA)

<MONTH YEAR>

<CUSTOMER NAME>

<CUSTOMER ADDRESS>

<CUSTOMER CITY STATE ZIPCODE>

This notice applies to your vehicle: <VIN>

**Subject: Service Action 19O3 – Coolant Bottle
Certain 2018 Model Year Volkswagen Tiguan and 2019 Model Year Volkswagen Jetta**

Dear Volkswagen Owner,

As part of Volkswagen's ongoing commitment to customer satisfaction, we are informing you of our decision to conduct a service action on certain 2018 model year Volkswagen Tiguan and 2019 model year Volkswagen Jetta vehicles. Our records show that you are the owner of a vehicle affected by this action.

What is the issue? The coolant bottle may leak coolant into the electrical connector for the coolant level sensor.

What will we do? Your authorized Volkswagen dealer will inspect and, if necessary, replace the coolant bottle. This work will take about two hours to complete and will be performed for you free of charge.

What should you do? Please contact your authorized Volkswagen dealer as soon as possible to schedule this service. To set up an appointment online, please visit www.vw.com/find-a-dealer.

This service action will be available for you **free of charge only until December 31, 2022**. If you wish to have this service performed after that date, your dealer's normal parts and labor cost associated with this repair will apply.

Lease vehicles and address changes If you are the lessor and registered owner of the vehicle identified in this action, please forward this letter immediately via first-class mail to the lessee within ten (10) days of receipt. If you have changed your address or sold the vehicle, please fill out the enclosed prepaid Owner Reply card and mail it to us so we can update our records.

Can we assist you further? If your authorized Volkswagen dealer fails or is unable to complete this work free of charge within a reasonable time, or if you should have any questions about this communication, please reach out to us using your preferred method of communication at www.vw.com/contact or by calling us at 800-893-5298.

Checking your vehicle for open Recalls and Service Campaigns To check your vehicle's eligibility for repair under this or any other recall/service campaign, please visit www.vw.com/owners/recalls and enter your Vehicle Identification Number (VIN) into the Recall/Service Campaign Lookup tool.

We apologize for any inconvenience this matter may cause; however we are taking this action to help ensure your vehicle continues to meet and exceed your expectations.

Sincerely,

Volkswagen Customer Protection

Customer Letter Example (CANADA)

<MONTH YEAR>

<CUSTOMER NAME>

<CUSTOMER ADDRESS>

<CUSTOMER CITY STATE ZIPCODE>

This notice applies to your vehicle: <VIN>

**Subject: Service Action 1903 – Coolant Bottle
Certain 2018 Model Year Volkswagen Tiguan and 2019 Model Year Volkswagen Jetta**

Dear Volkswagen Owner,

As part of Volkswagen's ongoing commitment to customer satisfaction, we are informing you of our decision to conduct a service action on certain 2018 model year Volkswagen Tiguan and 2019 model year Volkswagen Jetta vehicles. Our records show that you are the owner of a vehicle affected by this action.

What is the issue? The coolant bottle may leak coolant into the electrical connector for the coolant level sensor.

What will we do? Your authorized Volkswagen dealer will inspect and, if necessary, replace the coolant bottle. This work will take about two hours to complete and will be performed for you free of charge.

What should you do? In order to limit any possible inconvenience, please contact your authorized Volkswagen dealer as soon as possible to schedule this service. Please keep in mind that your dealer may need additional time for the preparation of the repair, as well as to accommodate their daily workshop schedule.

This service action will be available for you **free of charge only until December 31, 2022**. If you wish to have this service performed after that date, your dealer's normal parts and labor cost associated with this repair will apply.

Lease vehicles and address changes If you are the lessor and registered owner of the vehicle identified in this action, please forward this letter immediately via first-class mail to the lessee within ten (10) days of receipt. If you have changed your address or sold the vehicle, please fill out the enclosed prepaid Owner Reply card and mail it to us so we can update our records.

Can we assist you further? If your authorized Volkswagen dealer fails or is unable to complete this work free of charge within a reasonable time, please contact Customer Relations, Monday through Friday from 8AM to 8PM EST by phone at 1-800-822-8987 or via our "Contact Us" page at www.vw.ca.

We apologize for any inconvenience this matter may cause; however we are taking this action to help ensure your vehicle continues to meet and exceed your expectations.

Sincerely,

Volkswagen Customer Protection

NOTE

- These repair instructions may differ from the labor operations and labor times listed in ELSA.
- Damages resulting from improper repair or failure to follow these work instructions are the dealer's responsibility and are not eligible for reimbursement under this action.
- This procedure must be read in its entirety prior to performing the repair.
- Due to variations in vehicle equipment and options, the steps/illustrations in this work procedure may not identically match all affected vehicles.
- Diagnosis and repair of pre-existing conditions in the vehicle are not covered under this action.
- When working during extreme temperatures, it is recommended that the vehicle be allowed to acclimate inside the shop to avoid temperature-related component damage/breakage.

Repair Overview



- Check coolant bottle for coolant migration.

Repair Instruction

Section A - Check for Previous Repair

TIP

If Campaign Completion label is present, no further work is required.

Applicable criteria ID(s)	Campaign/Action Status
01 ← 2	Open ← 1

EXAMPLE

- Enter the VIN in Elsa and proceed to the “Campaign/Action” screen.

TIP

On the date of repair, print this screen and keep a copy with the repair order.

- Confirm the Campaign/Action is open <arrow 1>. If the status is closed, no further work is required.
- Note the Applicable Criteria ID <arrow 2> for use in determining the correct work to be done and corresponding parts associated.
- **All Safety Recalls MUST be completed before starting this Campaign.**

Proceed to Section B

Section B – Coolant Bottle Inspection

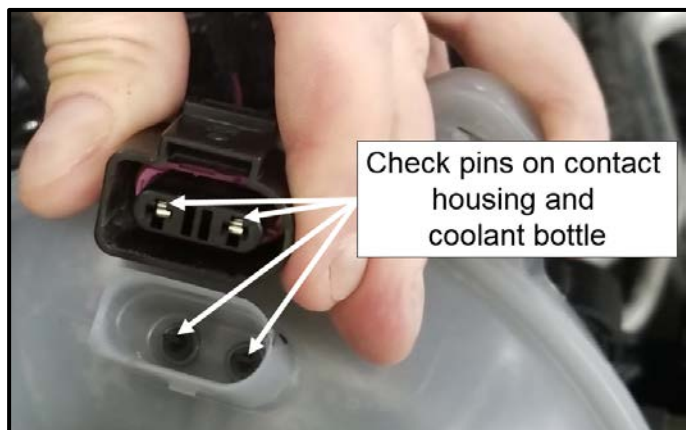

Inspect coolant level sensor wiring connector and coolant bottle connector housing:

- If coolant or corrosion **IS FOUND** at the coolant level sensor wiring connector and coolant bottle connector housing:
 - Coolant bottle requires replacement.
 - Coolant bottle connector and connector pins require inspection.
 - -J519- requires inspection.
 - TIGUAN ONLY: Ambient temperature sensor requires inspection.
 - **Proceed to Section C.**
- If coolant or corrosion **IS NOT** found at the coolant level sensor wiring connector and coolant bottle connector housing:
 - Reconnect the coolant level sensor connector to the coolant bottle.
 - No further work is required.
 - **Proceed to Section E.**

Section C – Coolant Bottle Replacement

Required Parts

<u>Criteria</u>	<u>Quantity</u>	<u>Part Number</u>	<u>Part Description</u>
02	1	5QM.121.407.C	Tank (Tiguan)
07	1	5QM.121.407.B	Tank (Jetta)

NOTE

The specified part numbers reflect the status at the start of this service action. Interim updates made in ETKA can cause a listed part number to become unavailable. In this case, the new part number specified in ETKA should be used.

Required Tools

	<p>Hose Clamps - Up To 25mm -3094- (or equivalent)</p>
---	--

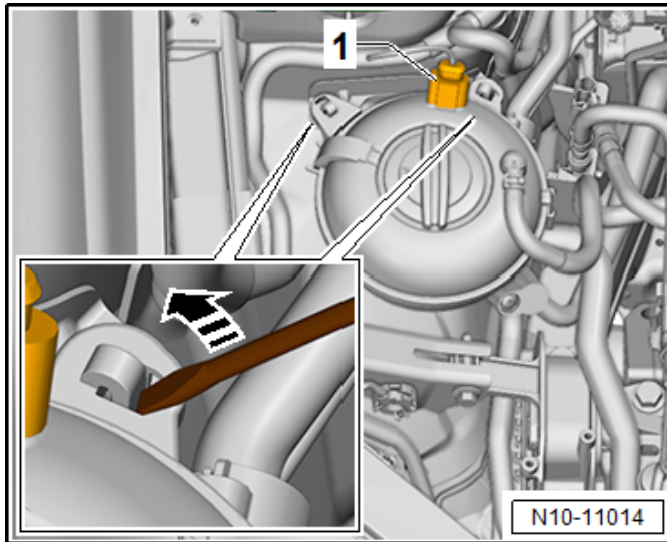

Replace coolant bottle:

- Turn off the vehicle ignition and remove the key from the vehicle.
- Remove coolant bottle cap.

⚠ WARNING

Risk of scalding due to hot steam and hot coolant.

- The coolant system is under pressure when the engine is warm.
- Cover the coolant bottle cap with a cloth and then open it slowly to release the pressure.
- Disconnect the coolant level sensor connector <1>.
- Clamp off hoses using Hose Clamps -3094-.
- Loosen hose clamps and note the original orientation of the clamps.
- Release the coolant bottle catches with a screwdriver in direction of <arrow>.
- Tip coolant bottle so coolant does not drain out and remove the hoses.
- Install new coolant bottle, install hoses and secure clamps in the same position they were originally oriented.

Crit.	Part Number	Part Description
02	5QM.121.407.C	Coolant bottle (Tiguan)
07	5QM.121.407.B	Coolant bottle (Jetta)

- Fill new coolant bottle with coolant from old bottle.

Since coolant migration was found, the -J519- and ambient temperature sensor must also be inspected.

Proceed to Section D.

Section D – Coolant Migration Inspection



Inspect coolant bottle connector:

- If corrosion is found on the connector pins:
 - The connector pins must be replaced.
- If only liquid coolant is found at the connector pins:
 - The coolant bottle connector housing must be cleaned with a dry, lint free cloth.
 - The coolant bottle connector pins must be cleaned with compressed air.



TIGUAN ONLY - Inspect ambient temperature sensor for coolant migration:

- Connector and sensor will be inspected.
- If NO liquid coolant or corrosion is found:
 - Reconnect connector to sensor.
- If corrosion is found on the connector or sensor pins:
 - Ambient temperature sensor must be replaced.
 - Corroded connector pins must be replaced.
- If only liquid coolant is found at the sensor, but there is NO corrosion:
 - Ambient temperature sensor connector and pins should be cleaned with a dry, lint free cloth.
 - Ambient temperature sensor connector and pins should also be cleaned with compressed air.

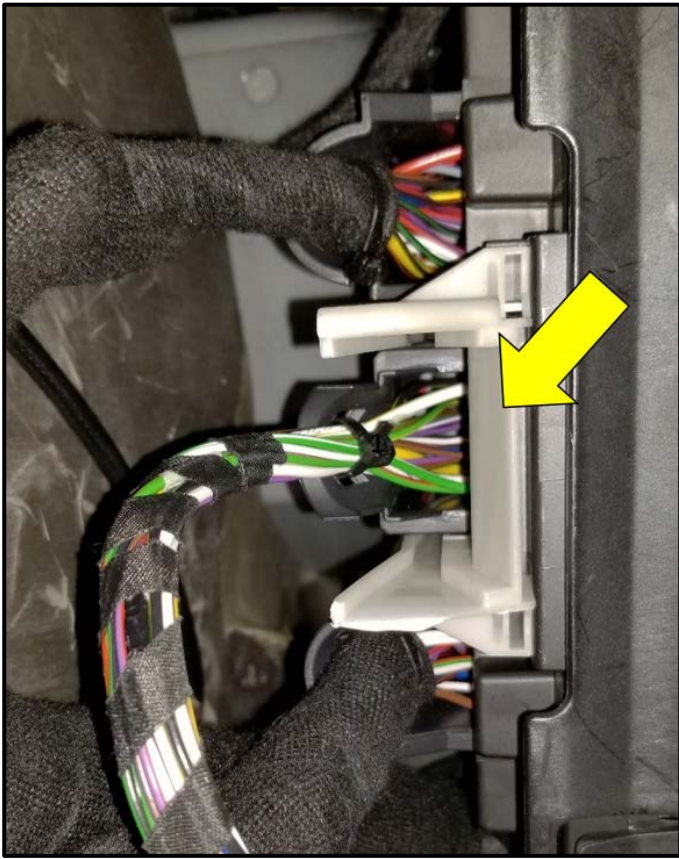

Access -J519-:

- See ELSA Repair Manual: *Repair manual > Electrical System > Electrical Equipment > 97 Wiring > Control Modules > Vehicle Electrical System Control Module -J519-, Removing and Installing*
- Remove the T46b connector <arrow>.

NOTE

- To disconnect the connector, press the catch <1>.
- Pivot the retaining bracket in direction of <arrow> and remove the connector.
- To pivot the retaining bracket on the center connector, the red connector lock must be additionally removed from the retaining bracket.

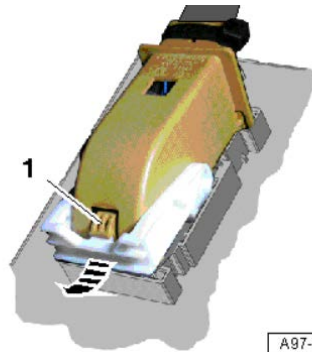

A97-10646

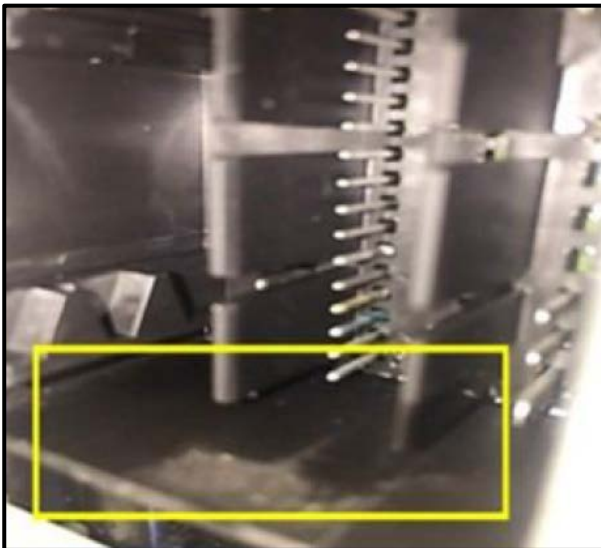
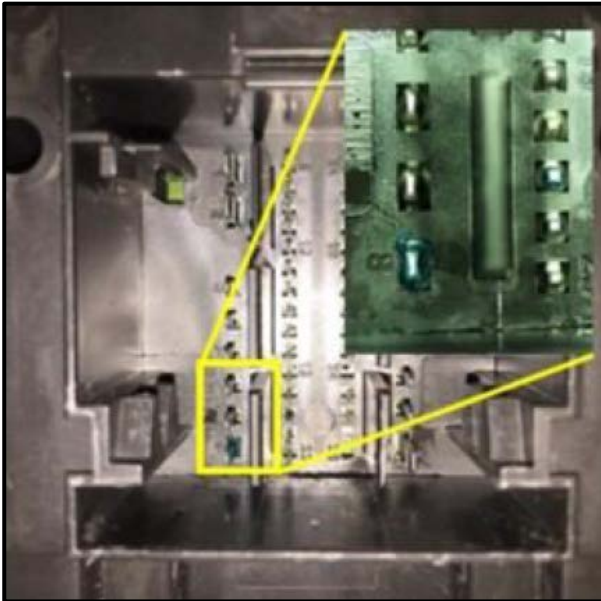
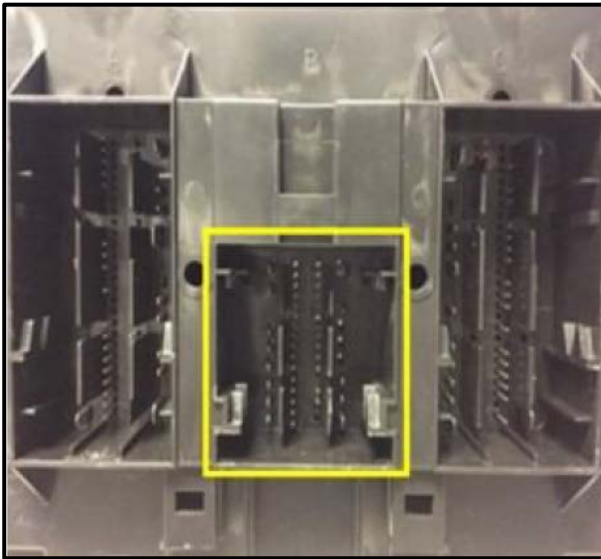

Inspect -J519- for coolant migration:

- Connector T46b connector will be inspected.
- If NO liquid coolant or corrosion is found:
 - Reassemble vehicle in reverse order of removal.
 - Proceed to Section E.
- If corrosion is found on the -J519- pins:
 - -J519- must be replaced.
 - Corroded connector pins must be replaced.
- If only liquid coolant is found at the -J519-, but there is NO corrosion:
 - -J519- should be cleaned with a dry, lint free cloth.
 - The -J519- pins must be cleaned with compressed air.

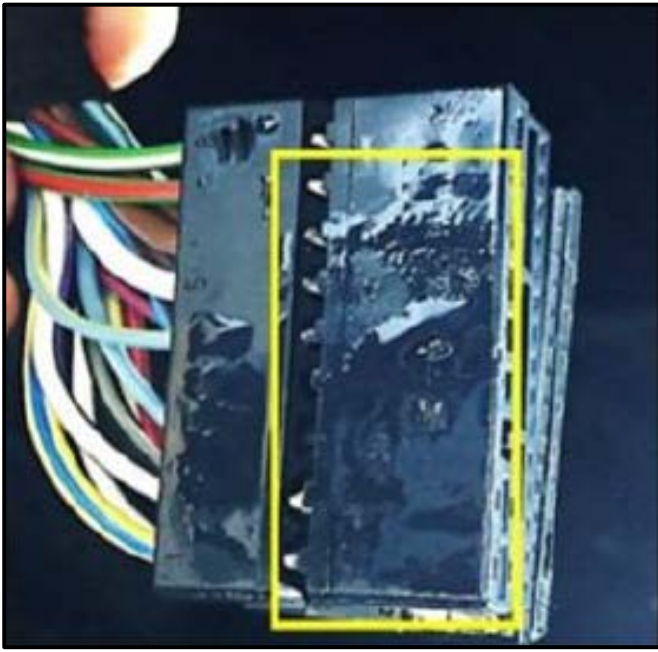

Check -J519- connector for coolant migration:

- Separate the individual terminal housings and inspect for coolant migration or corrosion.
 - See Appendix A for detailed disassembly instructions for separating the individual pin terminal housings from the -J519- connector housing.
- If NO liquid coolant or corrosion is found:
 - Reassemble vehicle in reverse order of removal.
 - Proceed to Section E.
- If corrosion is found on the -J519- connector pins:
 - Corroded connector pins must be replaced.
- If only liquid coolant is found on the -J519-, but there is NO corrosion:
 - -J519- connector housing must be cleaned with a dry, lint free cloth.
 - The connector pins must be cleaned with compressed air.
- Once all necessary -J519- repairs have been performed, **Proceed to Section E.**

Section E – Campaign Completion Label

Install Campaign Completion Label

- Fill out and affix Campaign Completion Label, part number CAMP 010 000, next to the vehicle emission control information label.

 **TIP**

Ensure Campaign Completion Label does not cover any existing label(s).

Proceed to Section F

Section F - Parts Return/Disposal

Properly store (retain), destroy or dispose of removed parts in accordance with all state/province and local requirements, unless otherwise indicated and/or requested through the Warranty Parts Portal (WPP) for U.S. and the Part Destruction and Core Disposition Report for Canada.

Appendix A – Terminal Releasing Documentation for -J519- 46 Pin Connector

See next page.

Terminal releasing documentation

WEB-CON-001552

Article No. 5Q0 937 702

Secondary

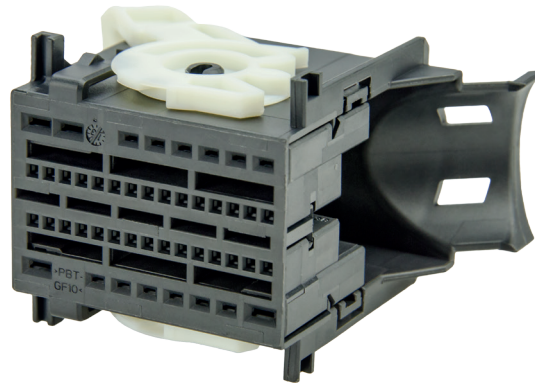

Detail

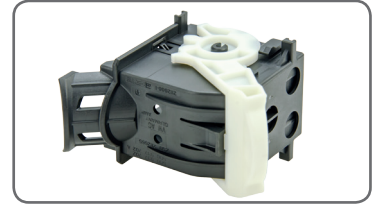

Secondary locking: 1
Primary locking: 3
Pins: <12
Type: female
Colour: black
Seal: no

Mating Conn. —

In this documentation, you will see application examples. These examples may differ in colour and number of pins. TKR cannot provide repair manuals.

In dieser Dokumentation werden Anwendungsbeispiele gezeigt. Diese Beispiele können sich in Farbe und Poligkeit unterscheiden. TKR kann keine Reparaturanleitung vorgeben.

Secondary locking

Examples documentation (WEB-CON-000337)

Tool WEB-ENT-11-0020-98

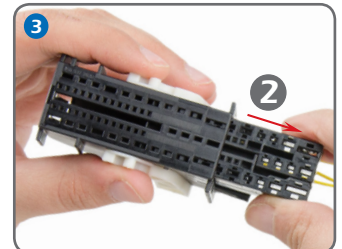
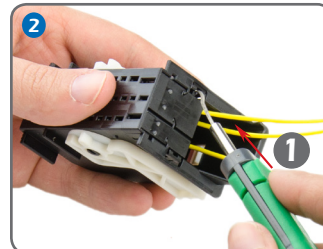

Terminal releasing documentation

WEB-CON-001552

Article No. 500 937 702

Primary

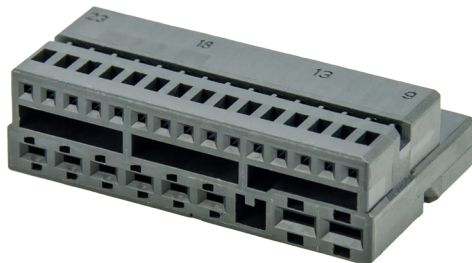

Repair wire

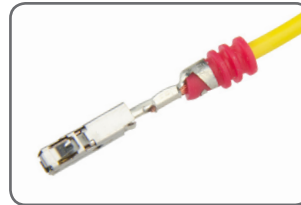

WEB-REP-000...
 ...010, ...011, ...037, ...038,
 ...039, ...041, ...042, ...117,
 ...118, ...119, ...120, ...121, ...139,
 ...186

Measuring lead

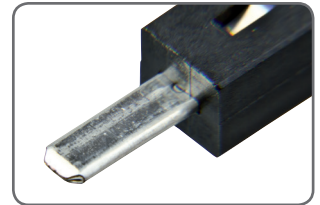

WEB-MES-000...
 ...083, ...094, ...099

In this documentation, you will see application examples. These examples may differ in colour and number of pins. TKR cannot provide repair manuals.

In dieser Dokumentation werden Anwendungsbeispiele gezeigt. Diese Beispiele können sich in Farbe und Poligkeit unterscheiden. TKR kann keine Reparaturanleitung vorgeben.

Primary locking

Examples documentation (WEB-CON-000337)

Tool **WEB-ENT-12-0010-99**

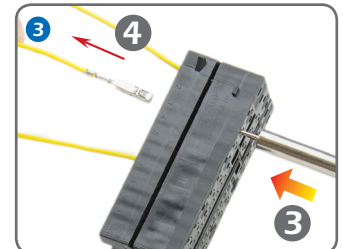
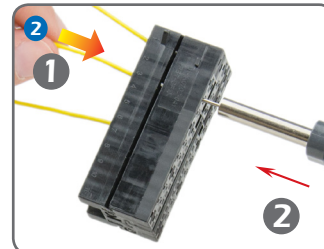

Tool **WEB-ENT-12-0030-99**

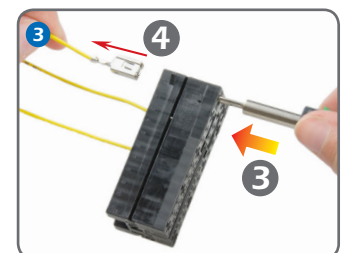
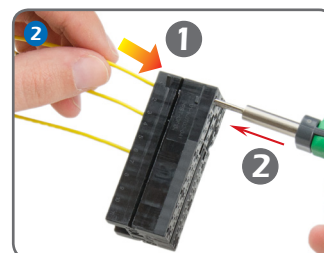
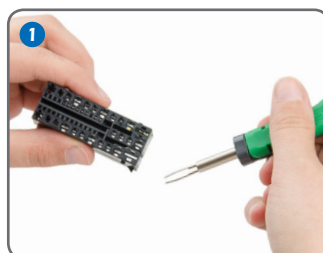
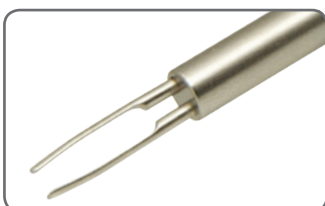

Tool **WEB-ENT-11-0026-98**

