



Countries: RUSSIA, AUSTRALIA, BAHAMAS, BOLIVIA, BRAZIL, BELIZE, CANADA, CHILE, TAIWAN, COLOMBIA, COSTA RICA, DOMINICAN REPUBLIC, ECUADOR, EL SALVADOR, TRINIDAD AND TOBAGO, UNITED STATES, URUGUAY, VENEZUELA, MEXICO, ARUBA, NICARAGUA, PERU, PUERTO RICO, Curaçao, GUAM, GUATEMALA, GUYANA, HAITI, HONDURAS, JAMAICA, KOREA, SOUTH KOREA, NEW ZEALAND, PANAMA, SOUTH AFRICA

Document ID: IK0500038

Availability: ISIS, FleetISIS, IsSIR

Major System: STEERING SYSTEM

Current Language: English

Other Languages: [Français](#), [Español](#).

Viewed: 15721

Revision: 23

Created: 8/15/2011

Last Modified: 9/18/2019

Author: Charles Schroeder

[Less Info](#)

Hide Details

Coding Information

Copy Link 	Copy Relative Link 	Bookmark View My Bookmarks	Add to Favorites 	Print 	Provide Feedback 	Helpful 454	Not Helpful 429
----------------------	-------------------------------	--	-----------------------------	------------------	-----------------------------	---------------------------	-------------------------------

Title: Steering Shake, Shimmy, Shudder, Steering Vibration

Applies To: Prostar/Lonestar and LT/RH with 14k front weight rated axles and below

CHANGE LOG

Please refer to the change log text box below for recent changes to this article:

09/18/2019 - Updated tread depth to mm and 32nds, removed decimal reading. Added part number for replacement rear engine mount for X15 powered vehicles. Combined steps 2-3 to include all wheel/tire checks at one step.

08/22/2019 - Added production break dates/ Updated author for feedback

07/22/2019 - Update link to IK1700017

06/10/2019 - Added part number for Dana high friction bearing kit and updated diag steps to reflect this.

DESCRIPTION

Steering intermittently goes into a shimmy after hitting a bump or during a curve.

SYMPTOMS

- The steering system may go into a shimmy after hitting a bump or during a curve. Normally the vehicle speed will need to be reduced in order to stop the shimmy. The symptoms may include a lateral (side to side) shake and possible oscillation of the steering wheel.
- Do not confuse this symptom with consistent shimmy when braking. Refer to [IK0400102](#) and [IK1300088](#).

SERVICE PARTS INFORMATION

Note:	
The high friction composite thrust bearing was added to production on the below dates:	
Hendrickson:	02/25/2019
Meritor:	02/04/2019 for PN 3899618C93, 3899622C94, 3899619C94, 3610259C94 and 3899623C94
Meritor:	07/08/2019 all other PN at Escobedo plant L or N VINs (LL851830 / LN168676)
Meritor:	08/12/2019 all other PN as Springfield plant H VINs (KH081197)
Dana:	08/12/2019

Kit Description	Part Number	Quantity Required	Notes
Steering Stabilizer	H60961167	1	For all front axles with 4 inch wide springs and tie rod tubes of 1.75 inches or smaller in diameter.
Longer Spring U-Bolts	Source Locally	2	Needed on some applications to install the steering stabilizer.
Hendrickson Axles ONLY: Kingpin Service Kit	H60961628	1	Complete kingpin service kit with one high friction composite thrust bearing for the driver's side
	H60961629	1	

Hendrickson Axles ONLY: Left Side Kingpin Service Kit			Contains just bushing, seals, bolts and high friction composite thrust bearing for the driver's side.
Meritor 13-14K Axles ONLY: Kingpin Service Kit	2519476C91	1	Complete kingpin service kit with one high friction composite thrust bearing for the driver's side
Meritor 13-14K Axles ONLY: Composite Bearing	2520212C91	1	Contains one high friction composite bearings with seals and wedges.
Meritor 12K Axles ONLY: Kingpin Service Kit	2519548C91	1	Complete kingpin service kit with one high friction composite thrust bearing for the driver's side
Meritor 12K Axles ONLY: Composite Bearing	2520213C91	1	Contains a high friction composite bearing with seals and wedges.
Dana Axles Only: Left Side Composite Bearing	2520702C91	1	Contains one high friction composite bearing, wedges and lash shims.
Rear Engine Mount	1664729C7	2	For vehicles with Cummins X15 only. Do not use in A26 powered vehicles.

Note:

If installed, only one high friction composite king pin bearing should be installed per vehicle and it should be installed on the **driver's side**.

TROUBLESHOOTING

Step	Action	Decision
1	<p>DIAGNOSTIC:</p> <p>If the truck is an LT or RH and has a constant vibration above 50mph follow IK1700017 and the LT service manual first.</p> <p>Is this an LT or RH with a constant vibration?</p>	<p>Yes: Refer to IK1700017 first.</p> <p>If IK1700017 has been completed proceed to step 2.</p> <hr/> <p>No: Please proceed to step 2.</p>

Step	Action	Decision
2	<p>DIAGNOSTIC: Tire Pressure, Runout and Balance</p> <p>Tire balance and runout are the primary factors in determining the likelihood of entering a shimmy event</p> <p>Under-inflated tires can cause poor handling, fast and/or irregular wear, decreased fuel economy and permanent structural damage to the tire.</p> <p>Overinflating can reduce traction, braking ability and handling, as well as result in uneven wear and an uncomfortable ride.</p> <p><u>Check front tire's cold inflation pressures daily, for specification refer to owner's manual.</u></p> <p>Measure lateral and radial run out on all tires using the tire runout gage RN 4532000. Tire Runout Gage Instructions Navistar PN 4532000</p>	<p>Yes: Please proceed to step 3.</p> <hr/> <p>No: Correct tire pressure, wear, runout and balance then proceed to step 3.</p>



Specification:

LoneStar LT/RH refer to the Truck Service Manual 0000885380.

All other vehicles: lateral and radial run out must be below .065".

Is lateral and radial run out within specification?

Uneven Wear: Check tread depth and note if tread is evenly worn. Minimum tread depth is 3 mm (4/32) on front tires and 2 mm (3/32) on other tires. Look for cuts or other damage to the tread sidewalls.

Wheel Balance: Ensure tires are properly static and dynamically balanced.

For LoneStar LT/RH refer to the Truck Service Manual 0000885380.

Use the [Tire Data Recording](#) document to record your findings

Note: Retreads are not recommended as a steer axle tire.

Do the tires meet the above criteria?

Step	Action	Decision
3	DIAGNOSTIC: Alignment Incorrect front axle alignment, specifically toe and caster, has been shown to be large contributing factors in increasing the likelihood of entering a shimmy event. Before making any changes refer to IK0200023 Navistar Wheel Alignment Policy . Verify alignment using IK0200013-Suggested alignment target values . Verify that the correct caster refer to TSI-12-02-01 .	Yes: Please proceed to step 4.
		No: Set the alignment using IK0200013 and proceed to step 4.

Step	Action	Decision
4	DIAGNOSTIC: Wheel Bearing End Play	Yes: Please proceed to step 5.

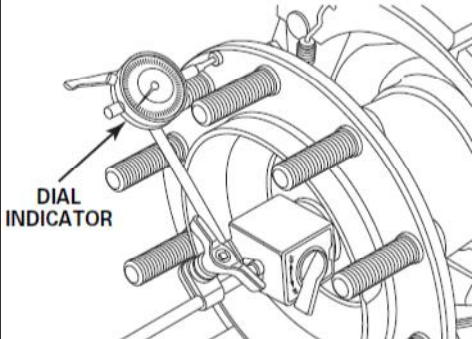
<p>Measure wheel bearing for excessive end play</p> <p>Use a dial indicator to verify acceptable endplay of 0.001"-0.005".</p>  <p>DIAL INDICATOR</p>	<p>No: Replace or adjust the wheel bearings as needed and proceed to step 5.</p> <p>Refer to ConMet Service Manual</p>
---	---

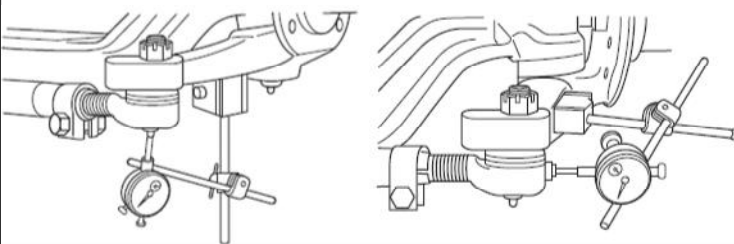
Step	Action	Decision
5	<p>DIAGNOSTIC: Drag Link and Tie Rod End Play</p>  <p>Use a dial indicator and measure the vertical and horizontal end play of the tie rod ends and drag link ends.</p> <p>Spec: less than 0.030 inches.</p> <p>Are the drag link and tie rod ends within specification?</p>	<p>Yes: Please proceed to step 6.</p> <p>No: Replace the drag link and tie rod ends as needed and proceed to step 6.</p>

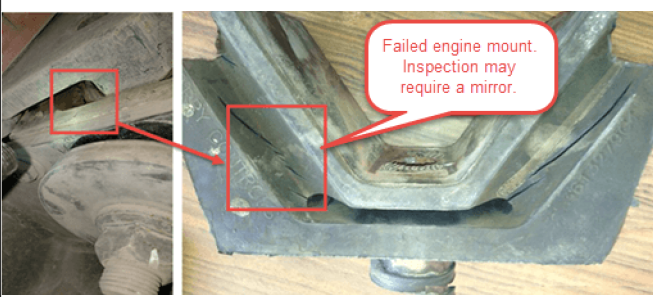
Step	Action	Decision
6	<p>DIAGNOSTIC: Spring Hangers, Cab Mounts, Engine Mounts and Frame Fasteners</p> <p>Inspect the spring hangers, shackles, and bushing for looseness, play and fastener torque.</p> <p>Inspect cab and engine mounts for excessive wear, being degraded and/or looseness.</p>  <p>Confirm fastener torque on all steering system, frame rail and crossmember, and fuel tank mounting brackets/supports.</p> <p>Example of a loose fuel tank support.</p>	<p>Yes: LT/RH refer to 0000885380</p> <p>Prostar/LoneStar refer to 0000863170</p> <p>Repair, torque, or replace fasteners and suspension components as needed and proceed to step 7.</p> <p>For A26 powered LT, the rear engine mounts should be replaced with a new part from the parts catalog if damage is found.</p> <p>For X15 powered LT, the rear engine mount should be replaced with 1664729C7 regardless if damage is found.</p> <p>No: Please proceed to step 7.</p> <p>For X15 powered LT, the rear engine mount should be replaced with 1664729C7 regardless if damage is found.</p>

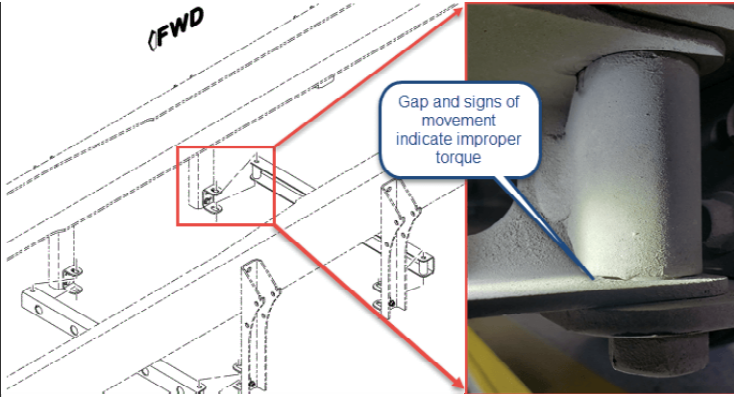

Was anything found loose or damaged?

Step	Action	Decision
7	<p>DIAGNOSTIC: Power Steering System.</p> <p>Determine if the power steering system has the correct fluid type (refer to IK0500058), it is full of fluid, free of aeration and operating properly.</p> <p>Any issue found?</p>	<p>Yes: LT/RH refer to 0000885380</p> <p>Prostar/LoneStar refer to 0000863170</p> <p>Correct the power steering system and proceed to step 8.</p>
		<p>No: Please proceed to step 8.</p>

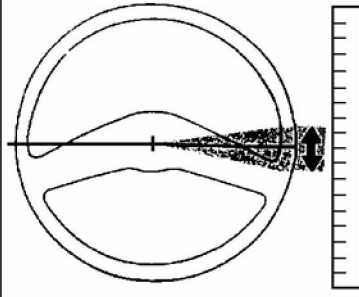
Step	Action	Decision
8	<p>DIAGNOSTIC: Steering System Lash</p> <p>With the engine off and the truck sitting on its tires, inspect for free play in the steering wheel. It should not exceed 2 inches of movement on an 18inch steering wheel with no movement in the tires.</p> <p>Inspect the steering shaft slip joint and u-joints for looseness.</p> <p>With a TRW gear: Verify steering gear lash per the TRW service manual.</p> <p>RH Sheppard gears are not adjustable and should not be tampered with.</p>  <p>Was anything found loose?</p>	<p>Yes: Replace any loose components and adjust the TRW steering gear lash as needed per the TRW service manual, then proceed to step 9.</p>
		<p>No: Please proceed to step 9.</p>

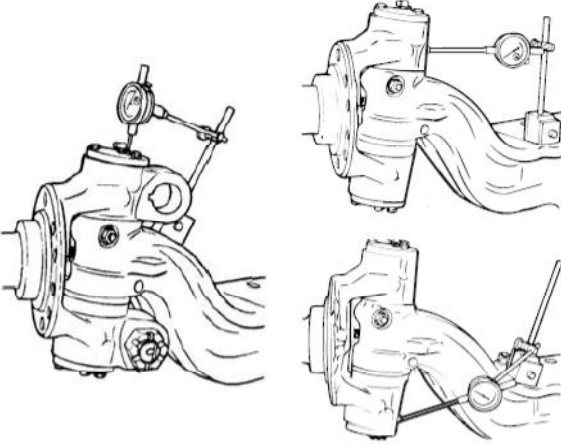
Step	Action	Decision
9	<p>DIAGNOSTIC: King Pin Vertical and Horizontal play</p> <p>Measure the king pin for excessive vertical horizontal end play.</p>  <p>Confirm the type of axle installed and use a dial indicator to verify acceptable play per supplier's specifications.</p> <p>Meritor: MM-2</p> <p>Dana: AXSM-0038</p> <p>Hendrickson: 17730-252</p> <p>Is King pin play out of specification?</p>	<p>Hendrickson:</p> <p>Yes: Install high friction composite kingpin service kit H60961628 per Hendrickson manual 59310-011.</p> <p>No: Install the high friction composite kingpin bearing only kit H60961629. If the service kit is not available, install the steering stabilizer H60961167 can be installed in its place per the below resolution.</p> <p>Proceed to step 10</p> <p>Dana:</p> <p>Yes: Install a king pin service kit and the high friction composite king pin kit 2520702C9.</p> <p>No: Install the high friction composite king pin kit 2520702C91. If the service kit is not available, install the steering stabilizer H60961167 can be installed in its place per the below resolution.</p> <p>Proceed to step 10</p> <p>Meritor 12K:</p> <p>Yes: Install high friction composite kingpin service kit 2519548C91 per TP1873.</p> <p>No: Install the high friction composite kingpin bearing only kit 2520213C91. If the service kit is not available, install the steering stabilizer H60961167 can be installed in its place per the below resolution.</p> <p>Proceed to step 10</p> <p>Meritor 13/14K:</p> <p>Yes: Install high friction composite kingpin service kit 2519476C91 per TP1873.</p> <p>No: Install the high friction composite kingpin bearing only kit 2520212C91. If the service kit is not available, the steering stabilizer H60961167 can be installed in its place per the below resolution.</p> <p>Proceed to step 10</p>
10	<p>DIAGNOSTIC: Once the high friction composite bearing is installed reevaluate for a shimmy/wobble</p> <p>Is the shimmy/wobble still present with the high friction bearing installed?</p>	<p>Yes: Install the steering stabilizer H60961167 per the resolution below.</p> <p>No: Repairs are completed</p>

RESOLUTION

Steering Stabilizer Installation Procedure:

Only if directed, install the steering stabilizer per the below procedure.



Park vehicle on a hard, flat surface, turn the engine off, set the parking brake, and block the wheels to prevent the vehicle from moving in either direction. Failure to do so may result in property damage, personal injury, and / or death.



If the vehicle must be raised, do not work under the vehicle supported only by jacks. Jacks can slip or fall over, potentially resulting in property damage, personal injury, and / or death.



Always wear safe eye protection when performing vehicle maintenance. Failure to do so may result in personal injury and / or death.

NOTE:

The steering stabilizer kit is designed to fit 1.75inch tie rod tubes. If the tie rod tube is 1.9 inches you will need to source 2 inch u-bolts locally for the kit and modify the tie rod tube mounting bracket accordingly.

NOTE:

Some Meritor and Dana axle configurations may require the mounting bracket (axle side) to be modified to bend slightly upward to clear the tie rod at full turn, and a longer axle U bolt installed (12 inch obtain locally).

1. Bring vehicle into the shop and park on flat hard surface.
2. Shift transmission to Park or Neutral, set parking brake, and install wheel chocks.
3. Remove the front U-bolt from the passenger side steer spring and discard.
4. On the tie rod assembly, measure the distance between the right and left grease zerks.
5. Divide your measurement from step 4 by two. (This will help locate the centerline of the tie rod assembly)
6. Mark the centerline of the tie rod assembly per figure 1 & 2.



Figure 1: Tie rod assembly

Item 1: Tie rod assembly centerline

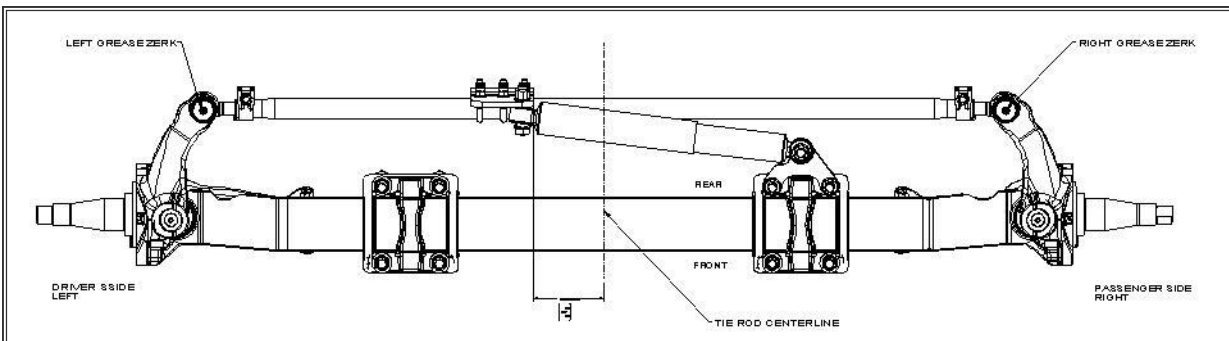

Figure 2: Steering Stabilizer to Axle Center Line

7. From the tie rod assembly centerline, make a second mark $5 \frac{7}{8}$ in towards the driver's side per figure 3. This will be the mounting location of the tie rod mounting plate.



Figure 3: Tie rod assembly

- Item 1: Tie rod assembly centerline (first mark)
Item 2: 5 7/8 from tie rod assembly centerline (second mark)

8. Follow the supplier instructions to attach the hardware for the stabilizer. [Hendrickson steering stabilizer assembly instructions 59310-053](#).

NOTE:

When installing the U-bolts on the tie rod tube do NOT use an impact, or damage to the tie rod tube is possible.

9. Ensure proper clearance between the tie rod tube and the shock mount at the U-bolt per figure 4. If required modify the mounting bracket to provide the needed clearance.

10. Before returning the truck to service, the steering system MUST be tested through its full range of travel. Any binding or contact at any point must be repaired before releasing the vehicle.

WARNING:

The Steering system must be inspected and tested for full range of travel to confirm there is no binding or contact after the stabilizer has been installed. Any binding or contact at any point in the full range of travel must be repaired.



Figure 4: Tie rod tube to mount clearance



Figure 5: Assembled Steering Stabilizer

WARRANTY INFORMATION

Warranty Claim Coding:

Refer to the [Warranty Coding Manual](#) for Group and Noun Codes.

Standard Repair Time(s):

Refer to the [SRT Manual](#) for Repair Times

OTHER RESOURCES

[Master Service Information Site](#)

[Hendrickson Steering Stabilizer Assembly Instructions 59310-053](#)

[Hendrickson Softek, Steertek, Airtex Service Manual 17730-252](#)

[Hendrickson Kingpin Bushing Service 59310-011](#)

[Hendrickson Parts Catalog SP-182](#)

[TRW Service Literature](#)

[Meritor Technical Bulletin TP-1873](#)

[Hide Details](#)

Feedback Information

Viewed: 15720

Helpful: 454

Not Helpful: 429

No Feedback Found

Copyright © 2019 Navistar, Inc.