



Technical Journal

TITLE:

Prior Approval - Lack of airflow causing poor cabin cooling

REF NO: TJ 34648.1.2	ISSUING DEPARTMENT: Technical Service	CAR MARKET: United States and Canada	
PARTNER: 3 US 7510 Volvo Car USA		ISSUE DATE: 2019-08-07	STATUS DATE: 2019-08-13
FUNC GROUP: 8720	FUNC DESC: Air distribution	Page 1 of 16	

“Right first time in Time”

Attachment

File Name	File Size
AC pressure, check VCC-504767-1.pdf	0.1091 MB
Customer Questionnaire TJ 34648.docx	0.0140 MB
TJ Instruction VCC-517278-1.pdf	1.5440 MB

Vehicle Type

Type	Eng	Eng Desc	Sales	Body	Gear	Steer	Model Year	Plant	Chassis range	Struc Week Range
234							2017-2017		-	201617-999952
238							2018-9999		-	201646-999952
256							2016-9999		-	201505-999952

CSC Customer Symptom Codes

Code	Description
TC	Blower fan/Does not work
6C	Buttons/control knobs on centre console (Climate)/No/reduced/incorrect function
KI	Temperature control/A/C not cold enough
TB	Temperature control/A/C does not work

VST Operation Number

VST Operation Number	Description
98734-2	Climate control unit check and remedy acc. to TJ34648
98733-2	Climate control unit check acc. to TJ34648



DTC Diagnostic Trouble Codes

Rows beginning with * are modified

Note! If using a printed copy of this Technical Journal, first check for the latest online version.

Text

DESCRIPTION:

***This repair is now on Prior approval**

If the customer complains of the lack of airflow combined with a poor cooling performance, follow the advice under service.

SERVICE:

Please follow the steps below:

1. Check if the A/C compressor control valve is stuck or not. The procedure is available in VIDA (Fault Tracing -> Function, 33 Climate control -> CSC, KI Temperature control, A/C not cold enough -> Test of the A/C components).
2. Check if the HVAC drain hoses are blocked and/or not draining.
3. Check the A/C pressure according to VCC-504767-1. If any leaks are found, repair and recharge the system.
4. If the results from step 1,2 and 3 are positive, install Resistor (in-line jumper cable) P/N 32241228 according to the method with VCC ID, VCC-517278-1.

Note: If a resistor harness is required, please fill out the attached questionnaire and open a Prior Approval report.

Warranty claim info:

To get warranty claim accepted for a job described in this TJ, please use following data:

VST OP Number:98734-2 or 98733-2, use one of the two operations.

VEHICLE REPORT:

Yes, please submit a Vehicle Report if the service solution described in this TJ has no effect. Use concern area "Vehicle Report" and sub concern area "Support needed", use function group 8720.

To view TJ attachment continue to next page. This TJ has three attachments.



Volvo Car Customer Service

Title	AC pressure, check	Page	1 (8)
Action		Operation number:	

Special tools

Description	Part No.
Gauge manifold R134a	981 4092
Gauge manifold R1234yf	981 4236

Safety information

Caution! Make sure to check which coolant is present in the A/C system.

Warning! Wear safety goggles and protective gloves.

Note! Always follow the manufacturer's instructions when handling the equipment.

See information about refrigerant , refer to:
General Safety Information
8 - Body and interior
87 - Climate units
870 - general

See information about air conditioning system , refer to:
General Safety Information
8 - Body and interior
87 - Climate units
870 - general

See information about the A/C-system , refer to:
General Information
8 - Body and interior
87 - Climate units
874 - cooling unit

Preparation

Open the hood.

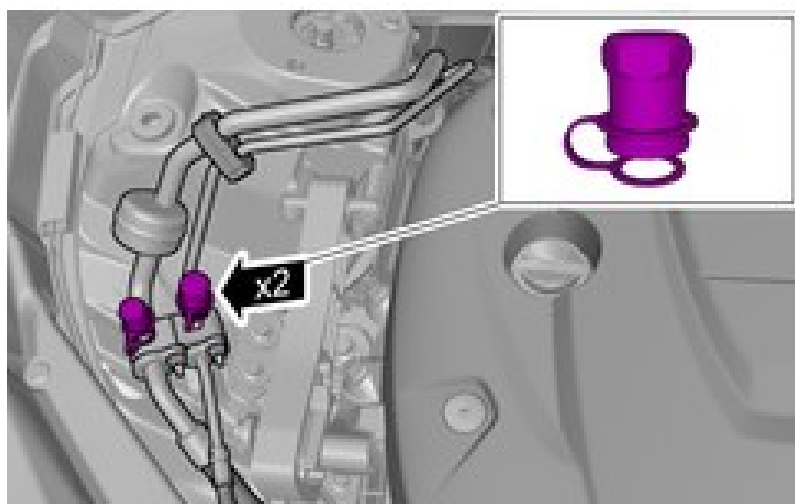

Remove the marked part.

1. **Torque:** 2016 XC90 (16-), 2017 S90 (17-), 2017 V90 (17-), 2017 V90 Cross Country, 2017 XC90 (16-), 2017 S90L, 2018 XC60 (18-), 2018 XC90 (16-), 2018 S90 (17-), 2018 V90 (17-), 2018 V90 Cross Country, 2018 S90L, 2019 XC60 (18-), 2019 V90 Cross Country, 2019 S90L, 2019 S90 (17-), 2019 XC90 (16-), 2019 V90 (17-), 2019 S60 (19-), 2019 V60 (19-), 2019 V60 Cross Country (19-), 2020 V60 (19-), 2020 S90 (17-), 2020 S90L, 2020 S60 (19-), 2020 V60 Cross Country (19-), 2020 V90 (17-), 2020 V90 Cross Country, 2020 XC60 (18-), 2020 XC90 (16-)

Valve cap (grey), to Service valve , 3 Nm

Torque: 2020 Polestar 1

Valve cap (grey), to Service valve , 3 Nm

Torque: 2017 S60 (11-18), 2017 S60 Cross Country, 2017 S60L, 2017 V60 (-18), 2017 V60 Cross Country (-18), 2017 XC60 (-17), 2018 S60 (11-18), 2018 S60 Cross Country, 2018 S60L, 2018 V60 (-18), 2018 V60 Cross Country (-18), 2019 S60L, 2020 S60L

Valve cap (grey), to Service valve , 3 Nm

Torque: 2017 V40 (13-), 2017 V40 Cross Country, 2018 V40 (13-), 2018 V40 Cross Country, 2019 V40 Cross Country, 2019 V40 (13-)

Valve cap (grey), to Service valve , 3 Nm

2. **Torque:** 2016 XC90 (16-), 2017 S90 (17-), 2017 V90 (17-), 2017 V90 Cross Country, 2017 XC90 (16-), 2017 S90L, 2018 XC60 (18-), 2018 XC90 (16-), 2018 S90 (17-), 2018 V90 (17-), 2018 V90 Cross Country, 2018 S90L, 2019 XC60 (18-), 2019 V90 Cross Country, 2019 S90L, 2019 S90 (17-), 2019 XC90 (16-), 2019 V90 (17-), 2019 S60 (19-), 2019 V60 (19-), 2019 V60 Cross Country (19-), 2020 V60 (19-), 2020 S90 (17-), 2020 S90L, 2020 S60 (19-), 2020 V60 Cross Country (19-), 2020 V90 (17-), 2020 V90 Cross Country, 2020 XC60 (18-), 2020 XC90 (16-)

Valve cap (black), to Service valve , 6 Nm

Torque: 2017 S60 (11-18), 2017 S60 Cross Country, 2017 S60L, 2017 V60 (-18), 2017 V60 Cross Country (-18), 2017 XC60 (-17), 2018 S60 (11-18), 2018 S60 Cross Country, 2018 S60L, 2018 V60 (-18), 2018 V60 Cross Country (-18), 2019 S60L, 2020 S60L

Valve cap (black), to Service valve

Connecting

Vehicles with refrigerant type R134a

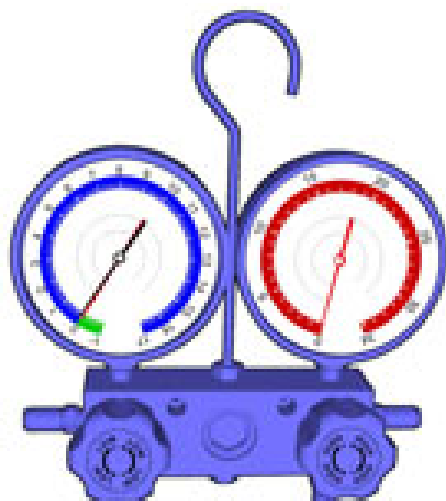

Caution! Never mix different types of refrigerant or equipment intended for them.

Special Tool: T9814092, Gauge manifold R134a

Vehicles with refrigerant type R123yf

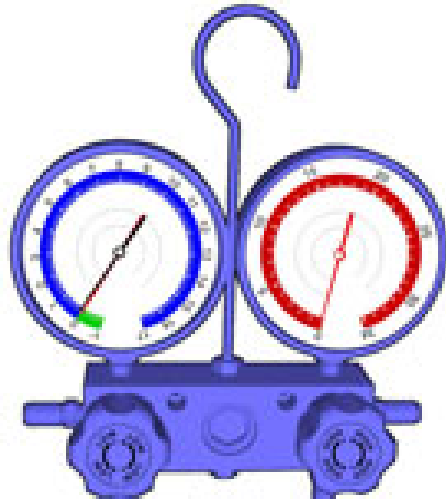

Caution! Never mix different types of refrigerant or equipment intended for them.

Special Tool: T9814236, Gauge manifold R1234yf

All vehicles

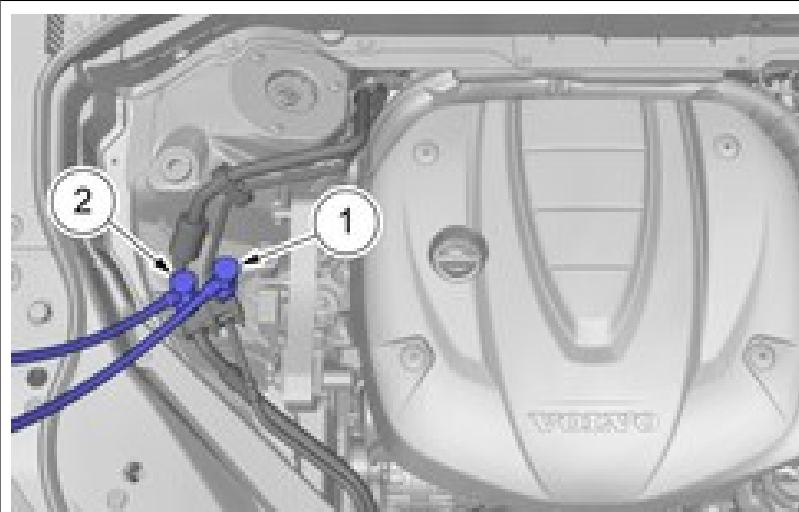

Install the hoses.

- 1 . Service valve high pressure
- 2 . service valve low pressure

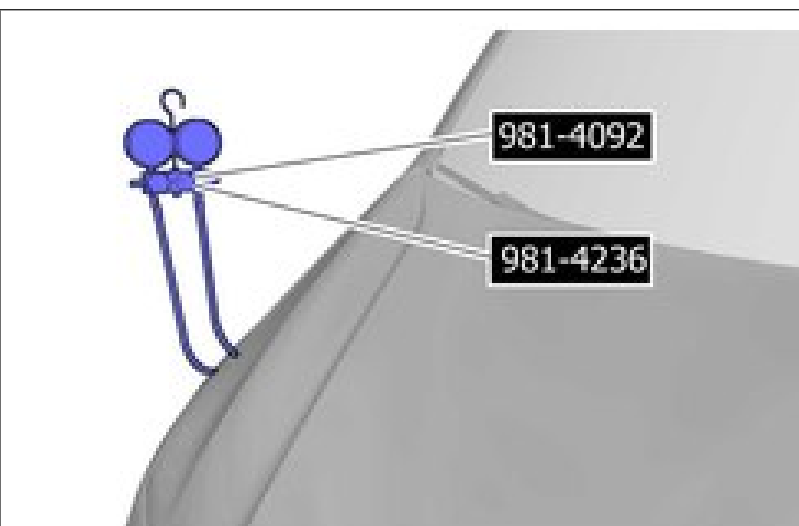

Caution! Close the hood carefully so as not to damage the hoses.

Special Tool: T9814092, Gauge manifold R134a

Special Tool: T9814236, Gauge manifold R1234yf

Activation



- 1 . Start the engine.
- 2 . Temperature = 20 °C driver/passenger
- 3 . Auto mode = Auto 3
- 4 . Close all doors and windows.
- 5 . Close the tailgate
- 6 . Let the system stabilize.

Check

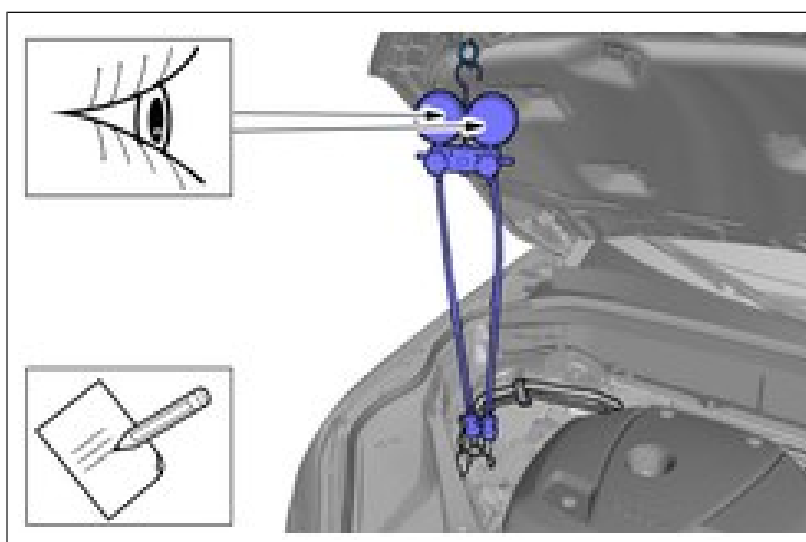

- 1 . Open the hood.
- 2 . Check the value.
- 3 . Note the value.

See information about A/C pressure , refer to:
 Specifications, mechanical
 8 - Body and interior
 87 - Climate units
 870 - general

Installation

Remove the Special Tool.

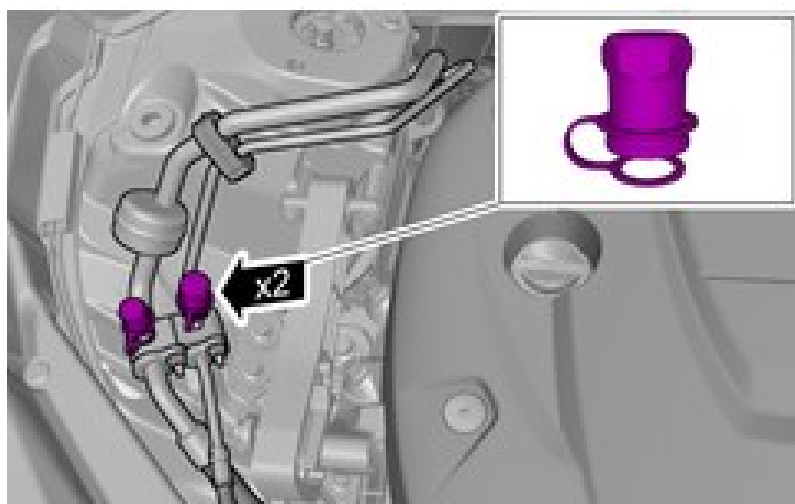

Install the marked component.

1. **Torque:** 2017 V40 (13-), 2017 V40 Cross Country, 2018 V40 (13-), 2018 V40 Cross Country, 2019 V40 Cross Country, 2019 V40 (13-)

Valve cap (grey), to Service valve , 3 Nm

Torque: 2017 S60 (11-18), 2017 S60 Cross Country, 2017 S60L, 2017 V60 (-18), 2017 V60 Cross Country (-18), 2017 XC60 (-17), 2018 S60 (11-18), 2018 S60 Cross Country, 2018 S60L, 2018 V60 (-18), 2018 V60 Cross Country (-18), 2019 S60L, 2020 S60L

Valve cap (grey), to Service valve , 3 Nm

Torque: 2016 XC90 (16-), 2017 S90 (17-), 2017 V90 (17-), 2017 V90 Cross Country, 2017 XC90 (16-), 2017 S90L, 2018 XC60 (18-), 2018 XC90 (16-), 2018 S90 (17-), 2018 V90 (17-), 2018 V90 Cross Country, 2018 S90L, 2019 XC60 (18-), 2019 V90 Cross Country, 2019 S90L, 2019 S90 (17-), 2019 XC90 (16-), 2019 V90 (17-), 2019 S60 (19-), 2019 V60 (19-), 2019 V60 Cross Country (19-), 2020 V60 (19-), 2020 S90 (17-), 2020 S90L, 2020 S60 (19-), 2020 V60 Cross Country (19-), 2020 V90 (17-), 2020 V90 Cross Country, 2020 XC60 (18-), 2020 XC90 (16-)

Valve cap (grey), to Service valve , 3 Nm

Torque: 2020 Polestar 1

Valve cap (grey), to Service valve , 3 Nm

2. **Torque:** 2017 V40 (13-), 2017 V40 Cross Country, 2018 V40 (13-), 2018 V40 Cross Country, 2019 V40 Cross Country, 2019 V40 (13-)

Valve cap (black), to Service valve , 6 Nm

Torque: 2020 Polestar 1

Valve cap (black), to Service valve , 6 Nm

Torque: 2017 S60 (11-18), 2017 S60 Cross Country, 2017 S60L, 2017 V60 (-18), 2017 V60 Cross Country (-18), 2017 XC60 (-17), 2018 S60 (11-18), 2018 S60 Cross Country, 2018 S60L, 2018 V60 (-18), 2018 V60 Cross Country (-18), 2019 S60L, 2020 S60L

Valve cap (black), to Service valve , 6 Nm

Torque: 2016 XC90 (16-), 2017 S90 (17-), 2017 V90 (17-), 2017 V90 Cross Country, 2017 XC90 (16-), 2017 S90L, 2018 XC60 (18-), 2018 XC90 (16-), 2018 S90 (17-), 2018 V90 (17-), 2018 V90 Cross Country, 2019 S90L, 2019 S90 (17-), 2019 XC90 (16-), 2019 V90 (17-), 2019 V90 Cross Country, 2020 S90L, 2020 S90 (17-), 2020 XC90 (16-), 2020 V90 (17-), 2020 V90 Cross Country, 2020 XC60 (18-), 2020 XC90 (16-)

Reset the vehicle settings after completed test or work.

Customer / questionnaire AC low flow

TODAYS DATE

What are the settings for the climate temperature and blower speed (flow)

Front Fan flow front

Rear Fan flow rear

How many times has this happened?

Is there a driver profile Y N which one has issue

Is this the first drive of the day? Y N

How long do you have to drive to get condition to happen?

Where was the customer traveling when the condition happened?

When conditions happens, does the vehicle interior temperature feel hotter?

What do you have to do to get the AC to operate correctly?

Just restart vehicle? Y N

Let it sit Y N how long?

Can you still hear the fan running? Y N

Has the airflow diminished? Y N

What are the A/C pressures? High Low Static



Volvo Car Customer Service

TJ Instruction VCC-517278-1

Title	Temperature sensor, evaporator	Page	1 (5)
Action	Product fix	Operation number:	98734-2 98733-2

Issue	Date	Reason
1	2019-06	First issue

Affected vehicles

Model year	Model
2017, 2018, 2019, 2020	S90/S90L
2019, 2020	S60/V60
2017, 2018, 2019, 2020	V90 (17-)
2017, 2018, 2019, 2020	V90 Cross Country
2016, 2017, 2018, 2019, 2020	XC90 (16-)



Materials

Materials	Qty.	Part No.	Notes
Adapter cable	1.0	32241228	Adapter cable / Resistor;

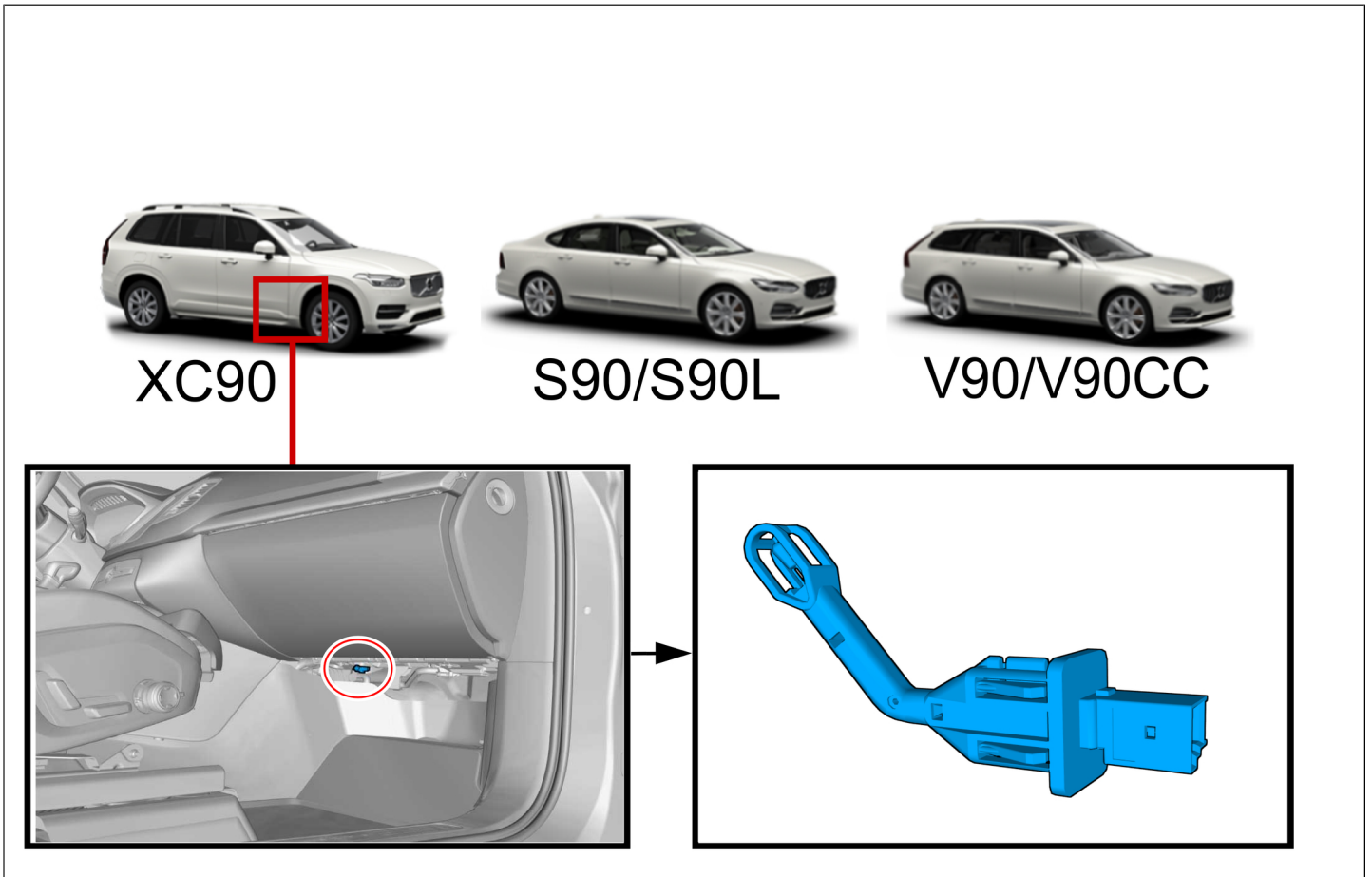
Orientation view

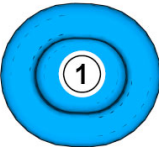
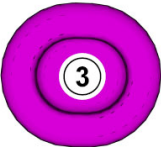
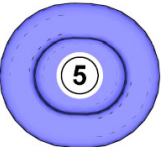
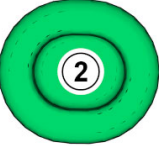
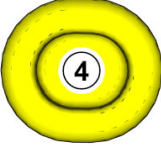

Color symbols

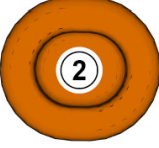
Note! This colour chart displays (in colour print and electronic version) the importance of the different colours used in the images of the method steps.

- 1 . Used for focused component, the component with which you will do something.
- 2 . Used as extra colors when you need to show or differentiate additional parts.
- 3 . Used for attachments that are to be removed/installed. May be screws, clips, connectors, etc.
- 4 . Used when the component is not fully removed from the vehicle but only hung to the side.
- 5 . Used for standard tools and special tools.
- 6 . Used as background color for vehicle components.

Removal

Set the vehicle to Inactive mode, described in user mode , refer to:

General Information

3 - Electrical system

30 - General

300 - general

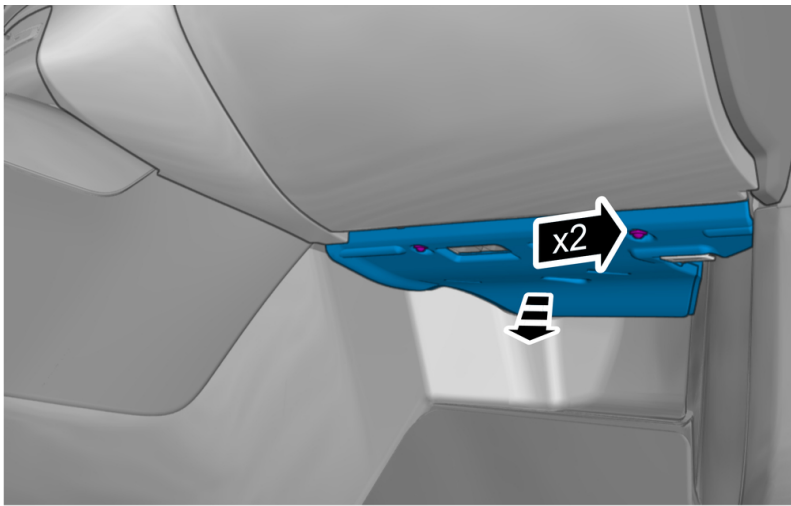

Remove the screws.
Detach the panel.

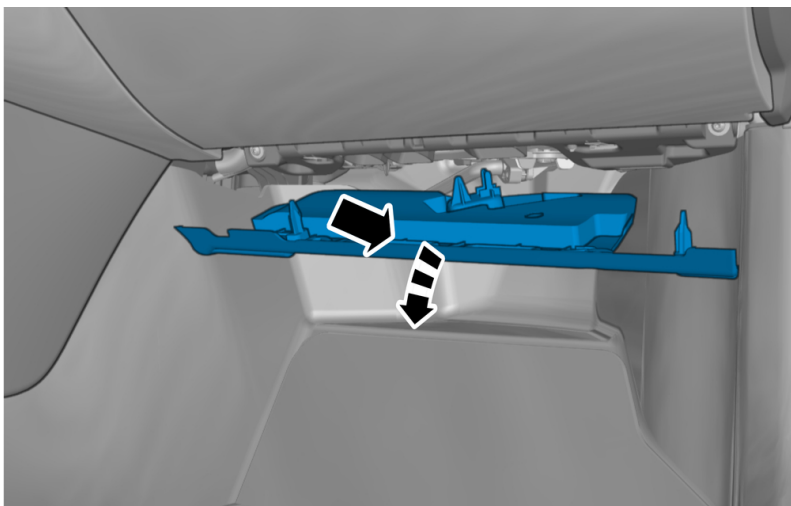

Remove the panel.

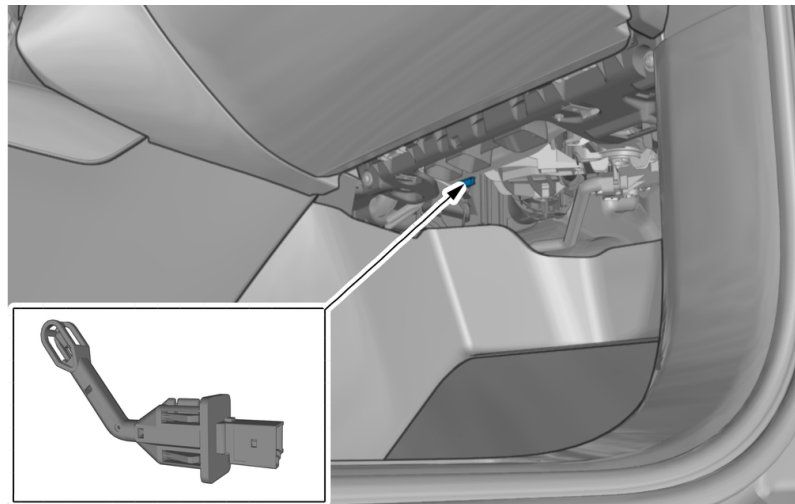

Note! Orientation view

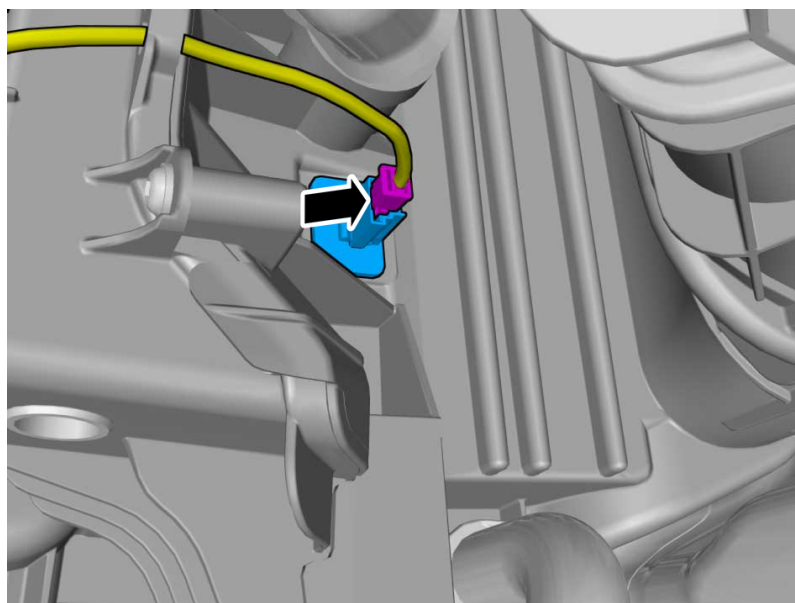

Disconnect the connector.

Modification

Install the marked component.

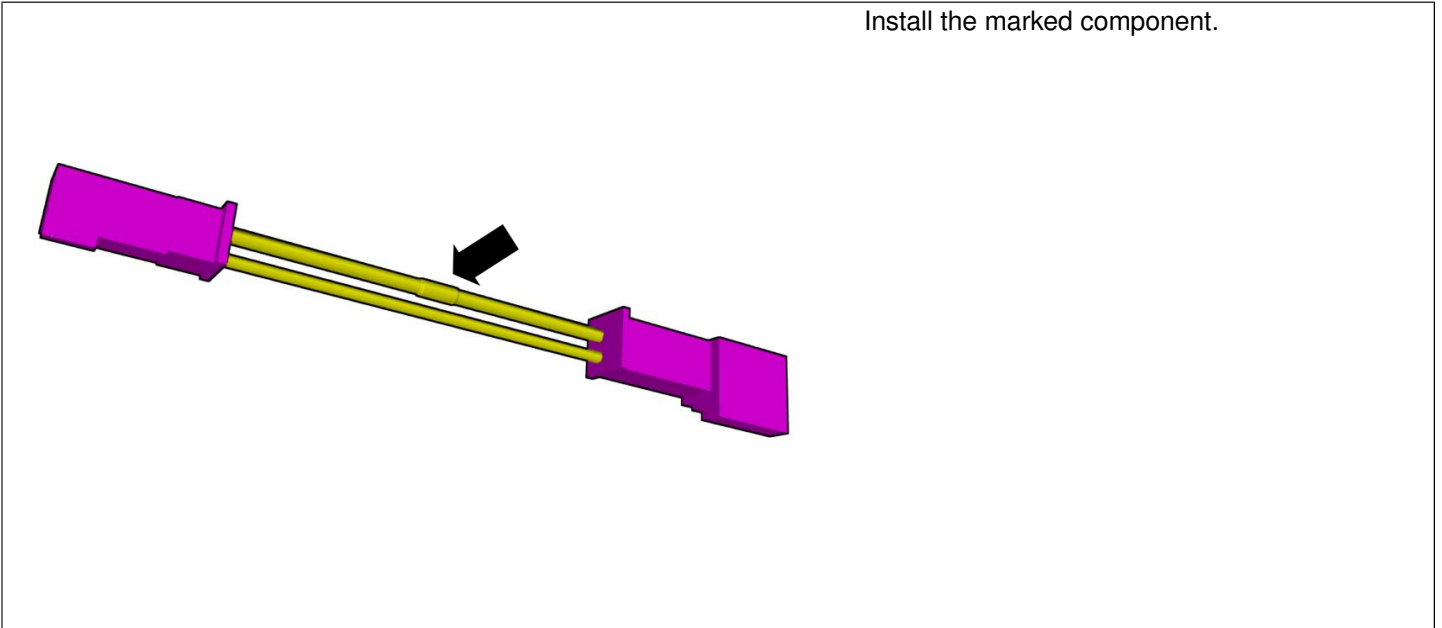

Caution! Make sure that the components are positioned correctly.

Connect the connectors.

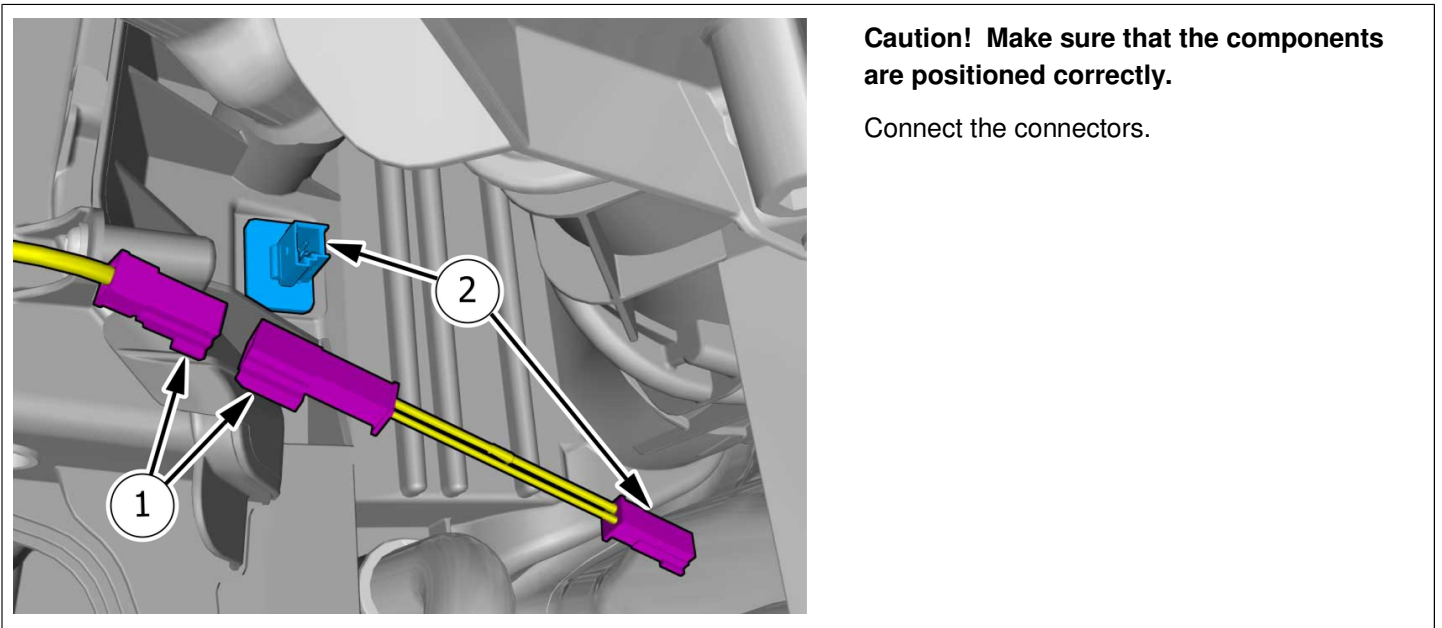

Installation

To install, reverse the removal procedure.