



SERVICE BULLETIN

| | | |
|-----------------------------|-------------------------|-------------------------|
| Classification: AT19-008 | Reference: NTB19-060 | Date: August 1, 2019 |
|-----------------------------|-------------------------|-------------------------|

2015-2018 NV200 AND 2014-2017 TAXI; DTC P17F0, P17F1, P0776, P2813, P1715, AND/OR P0841 STORED

APPLIED VEHICLES: 2015-2018 NV200 (M20)
2014-2017 Taxi

IF YOU CONFIRM

One or more of the following DTCs are stored:

P0776, P2813, P0841, P17F0, P17F1, P1715

IMPORTANT:

- If DTCs other than those listed above are stored, this bulletin **does not apply**.
- If the customer states the engine stalled while going from 'P' or 'N' range to 'R' or 'D' range, this bulletin **does not apply**.
- If DTC P17F0 and/or P17F1 are the only DTCs stored and there is no customer complaint of judder, this bulletin **does not apply**.
- If DTC P1715 is the only code stored, this bulletin **does not apply**.

ACTION

See Repair Flow Chart on page 2 to confirm if this bulletin applies.

NOTE: Pages 59 and 95 must be printed and attached to the repair order.

Nissan Bulletins are intended for use by qualified technicians, not 'do-it-yourselfers'. Qualified technicians are properly trained individuals who have the equipment, tools, safety instruction, and know-how to do a job properly and safely. NOTE: If you believe that a described condition may apply to a particular vehicle, DO NOT assume that it does. See your Nissan dealer to determine if this applies to your vehicle.

Repair Flow Chart

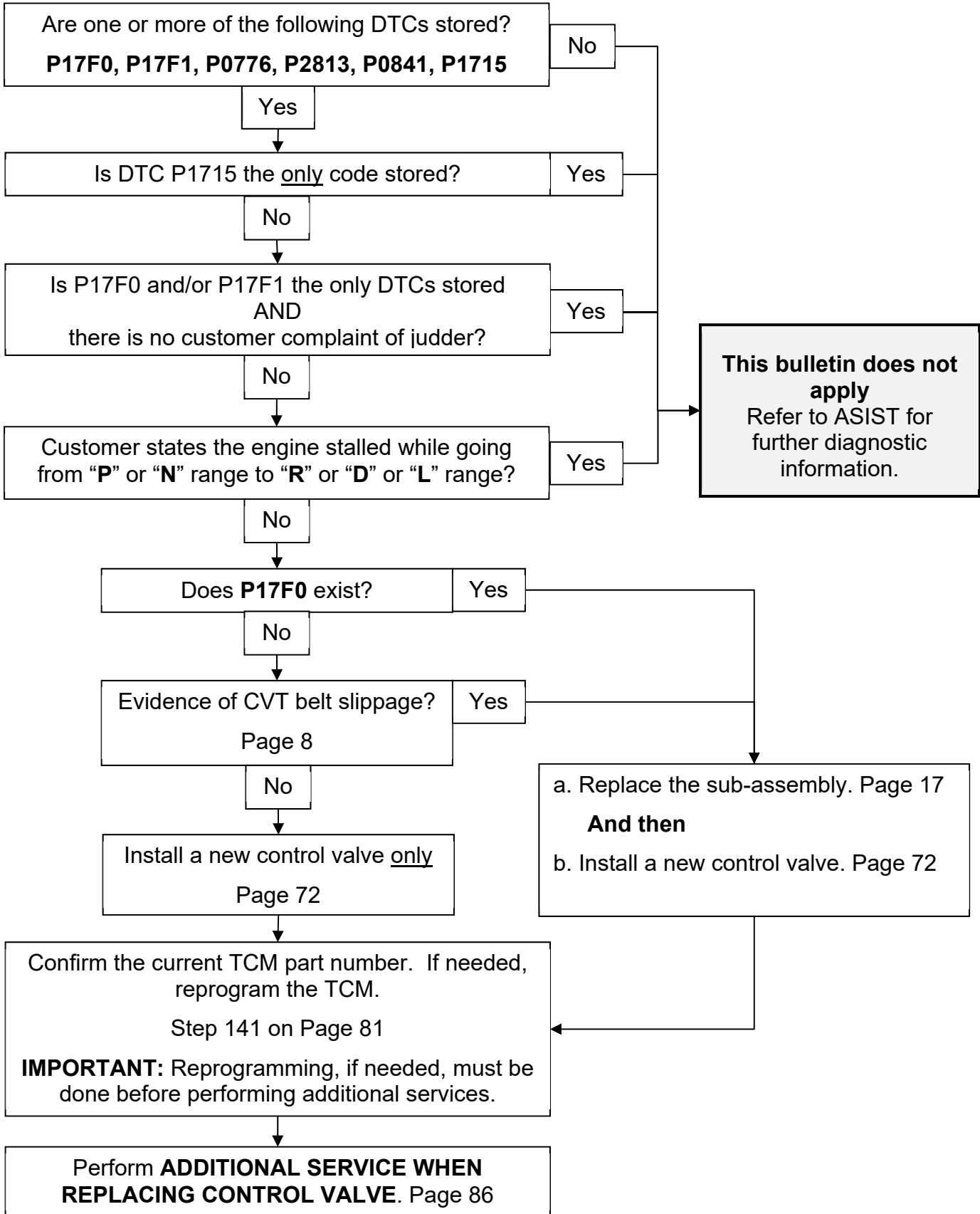

Table of Contents

| | |
|---|---------|
| • Required Tools / Material..... | page 4 |
| • Essential Tools..... | page 4 |
| • Weights..... | page 6 |
| • Precautions when Disassembling a CVT Assembly..... | page 7 |
| • Control Valve Removal and CVT Belt Inspection..... | page 8 |
| • CVT Assembly Removal..... | page 17 |
| • Remove the Converter Housing, Oil Seals, Oil Pump Cover, Oil Pump and Oil Filter..... | page 20 |
| • Clean the CVT case surfaces..... | page 28 |
| • Clean the Oil Passages in the CVT Case, Oil Pump Cover, and CVT Filter Area..... | page 29 |
| • New Oil Pump Installation..... | page 31 |
| • Replace the Side Cover – Pulleys and Belt (sub-assembly)..... | page 33 |
| • Clutch Total Endplay Adjustment – Thrust Bearing Selection..... | page 56 |
| • Clean the Converter Housing Passages..... | page 62 |
| • CVT Reassembly..... | page 64 |
| • Control Valve Strainer and Pan Installation..... | page 72 |
| • Install the CVT Assembly..... | page 78 |
| • TCM Reprogramming..... | page 79 |
| • ADDITIONAL SERVICE WHEN REPLACING CONTROL VALVE..... | page 86 |
| • PARTS INFORMATION..... | page 91 |
| • CLAIMS INFORMATION..... | page 93 |
| • PARTS KITS REFERENCE TABLE..... | page 95 |

Required Tools / Materials

- Cherry picker / engine hoist / lifting arm (never handle replacement CVT sub-assembly by hand)
- Strap or chain to lift and lower CVT and sub-assembly
- Petroleum jelly or equivalent
- Extendable magnet
- Large clean surface / 1 to 2 work tables
- Vernier calipers
- Brake cleaner or equivalent solvent
- 90% Isopropyl alcohol
- Lens swab
- Plastic scraper

Essential Tools

Additional Essential Tools are available from Tech•Mate online: www.nissantechmate.com, or by phone: 1-800-662-2001.

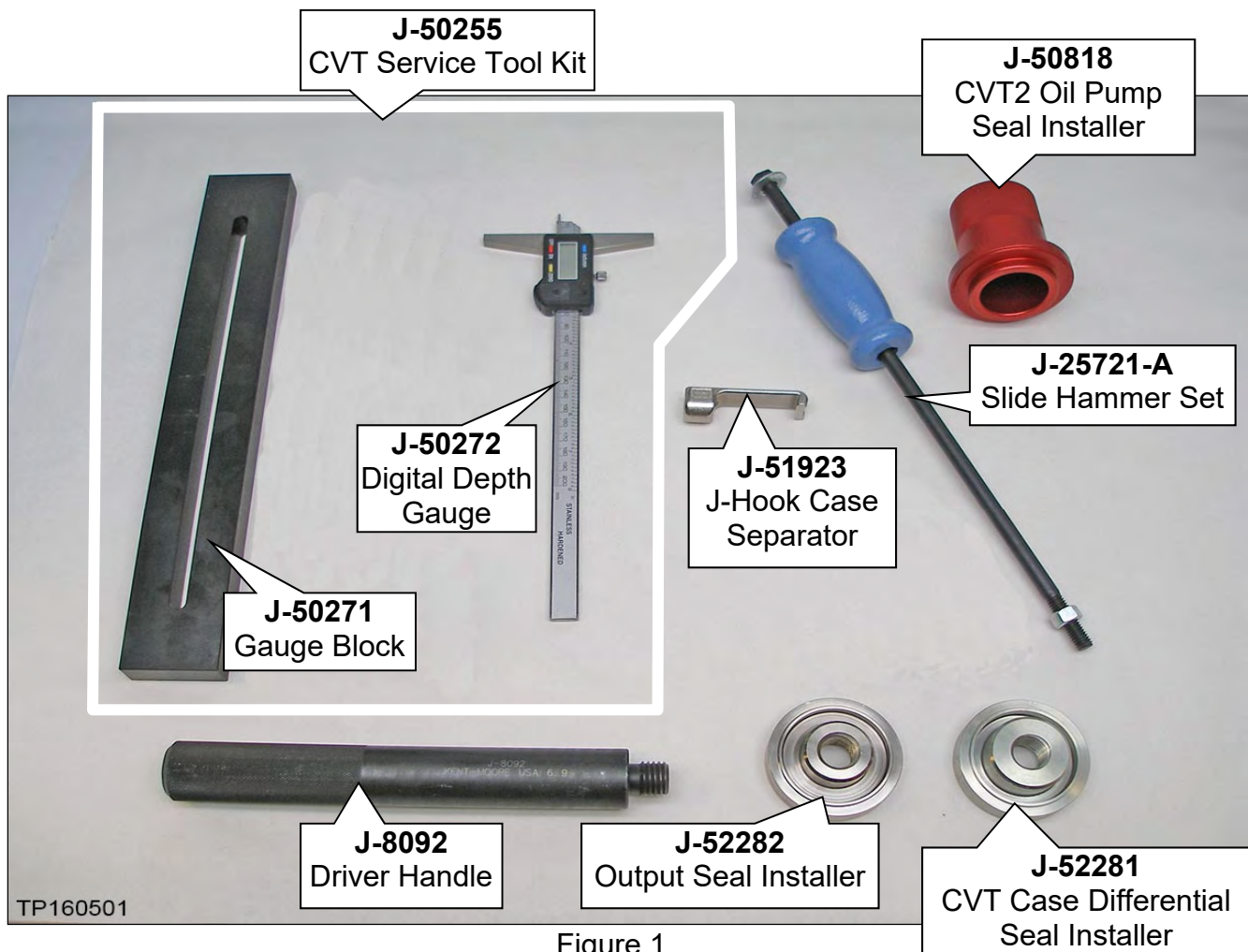

Figure 1

Essential Tools (continued)



Figure 2

J-51959
Guide Pins

CAUTION: Always handle the CVT and component assemblies carefully and with the appropriate lifting tools.

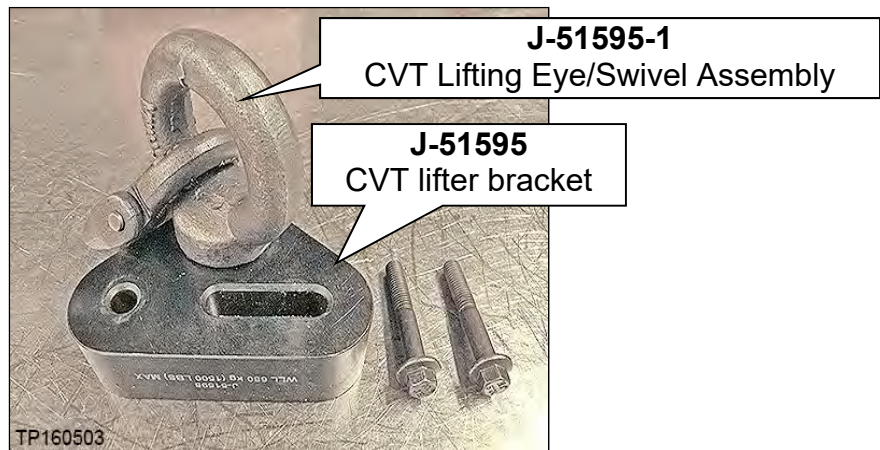

Figure 3

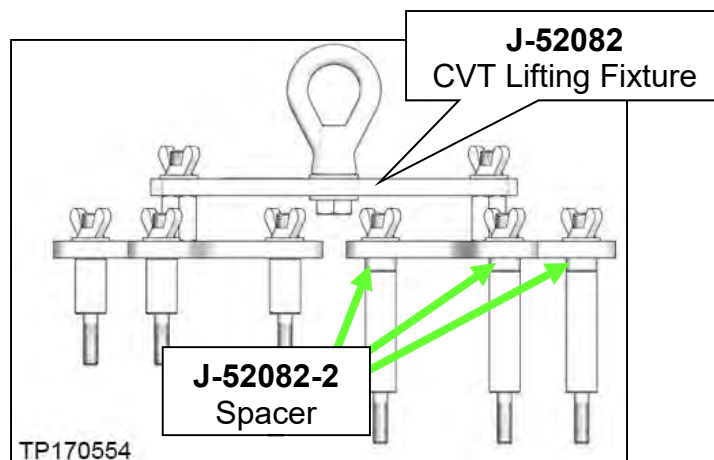
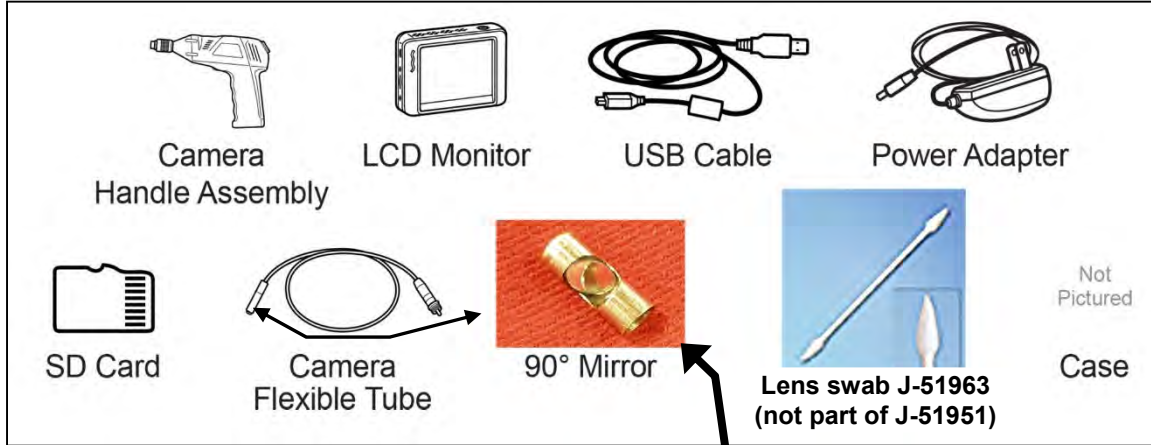

Figure 4

Essential Tools (continued)

Tech Cam J-51951



- Additional Tech Cam J-51951 kits or components are available from Tech•Mate.

Weights

- CVT assembly: 300 lbs. approximately
- CVT sub-assembly: 65 lbs. approximately

SERVICE PROCEDURE

IMPORTANT: Repairs performed for this bulletin require CONSULT-III plus Diagnostic result reporting function-Setting to be ON and Diagnosis (All Systems) to be performed. If not done, it may result in a repair being non-warrantable.

Precautions when Disassembling a CVT Assembly

Transmissions are vulnerable to particles (dust, metal, lint, etc.).

When disassembling a CVT, make sure your work environment (shop, workbench, etc.), transmission area (sub-frame, oil pan, harness connector, etc.), and your hands are free of contamination.

IMPORTANT:

- Wash and clean the exterior of the CVT assembly prior to disassembling.
CAUTION: Cover all air breather and drive shaft holes to prevent water intrusion.
- Apply rust penetrant to locator / dowel pins on the torque converter housing and side cover of the CVT and allow to soak as needed.
- Refrigerating oil seals may help in assembly (axle and T/C seals).
- Only disassemble those parts which are mentioned in this bulletin.
- Make sure all parts are clean prior to assembling / installing.
 - Unpack service parts just before installation.

- Store the related parts that have been removed separately to prevent being mixed up; small cups can be used.



Figure 6

IMPORTANT: The CVT unit “wiring harness connector” will be reused during this procedure. The wiring harness can be disconnected from the control valve at the wiring harness connector and remain in the CVT.

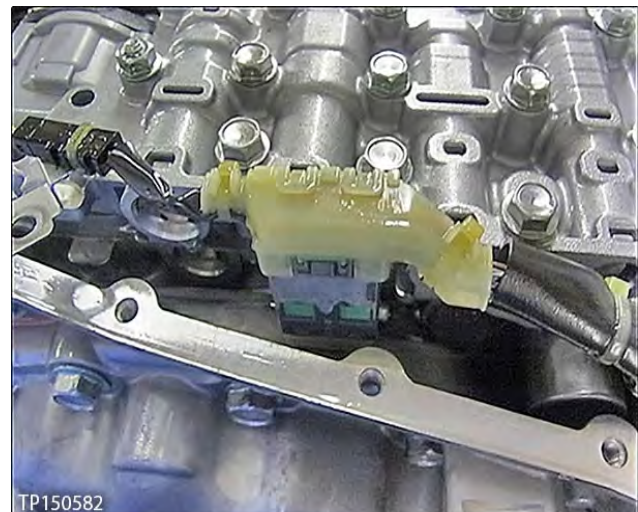

Figure 7

Control Valve Removal and CVT Belt Inspection

1. Write down all radio station presets.

| Presets | 1 | 2 | 3 | 4 | 5 | 6 |
|---------|--------|---------|------|-----------------|---|---|
| AM | | | | | | |
| FM 1 | | | | | | |
| FM 2 | | | | | | |
| SAT 1 | | | | | | |
| SAT 2/3 | | | | | | |
| Bass | Treble | Balance | Fade | Speed Sen. Vol. | | |

2. Disconnect both battery cables, negative cable first.

3. Remove the control valve.

Before lifting the vehicle:

- Place the transmission gear selector in Neutral.
- For control valve removal, refer to the ESM: section **Transaxle & Transmission**.

NOTE: The number '7' is on the head of all bolts that need to be removed for control valve removal. Do not remove any bolt that does not have the number '7'.

CAUTION: Never allow any chemicals or fluids other than NS-3 CVT fluid or equivalent to enter the CVT assembly. Never allow any foreign debris, dust, dirt, etc. to enter the CVT assembly.

- For additional information, see video # 544: "CVT Belt Inspection". This video is located under the TECH TRAINING GARAGE VIDEOS tab in Virtual Academy.

Exploded View

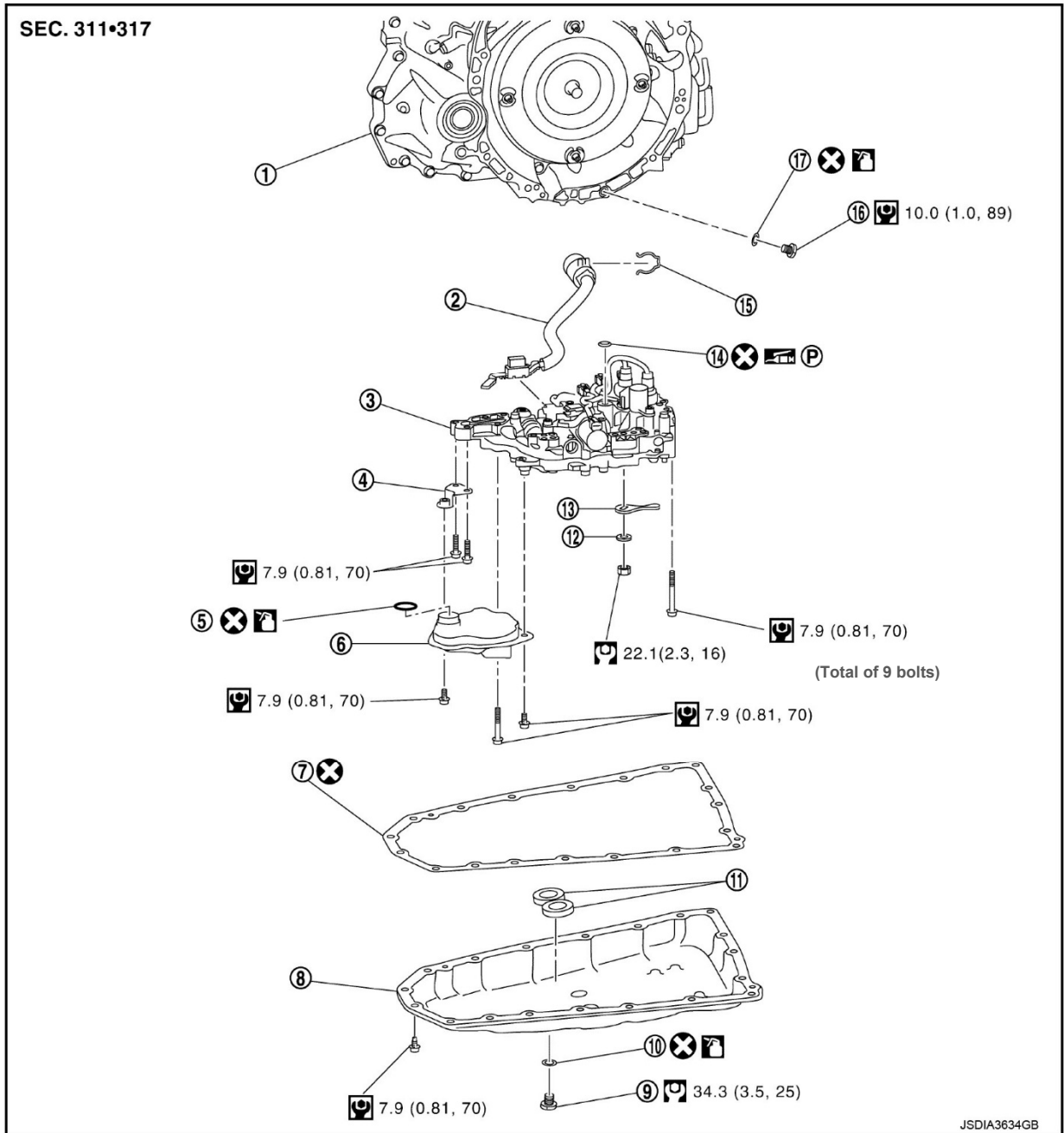

Figure 8

- | | | |
|----------------------|--------------------------|-------------------------|
| ① Transaxle assembly | ② Terminal cord assembly | ③ Control valve |
| ④ Bracket | ⑤ O-ring | ⑥ Oil strainer assembly |
| ⑦ Oil pan gasket | ⑧ Oil pan | ⑨ Drain plug |
| ⑩ Drain plug gasket | ⑪ Magnet | ⑫ Spring washer |
| ⑬ Manual plate | ⑭ Lip seal | ⑮ Snap ring |
| ⑯ Overflow plug | ⑰ O-ring | |
- ⊗ : Always replace after every disassembly.
- ☑ : N·m (kg-m, ft-lb)
- ☑ : N·m (kg-m, in-lb)

4. Secure the front right tire with a suitable strap, so that it cannot rotate.
 - This will assist in making the belt turn.
5. Mark the front left tire with a suitable marking.
 - This will assure all 360° of the belt is inspected.



Figure 9

6. Using borescope J-51951 with its mirror attachment, insert the camera lens between the CVT case and pulley where shown in Figure 10 and Figure 11.

- Insert the lens approximately seven (7) inches, and then view the side of the belt that contacts the pulley.

NOTE:

- Clean the camera lens and mirror before each inspection. Use 90% isopropyl alcohol and a lens swab from Lens Swab packet J-51963 listed in the **PARTS INFORMATION** on page 91.
- Before inspecting, make sure the batteries in the camera handle and LCD monitor are charged.

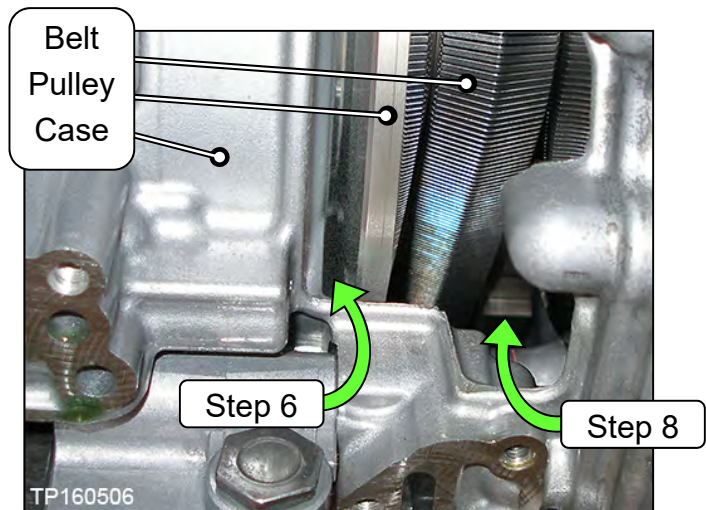

Figure 10

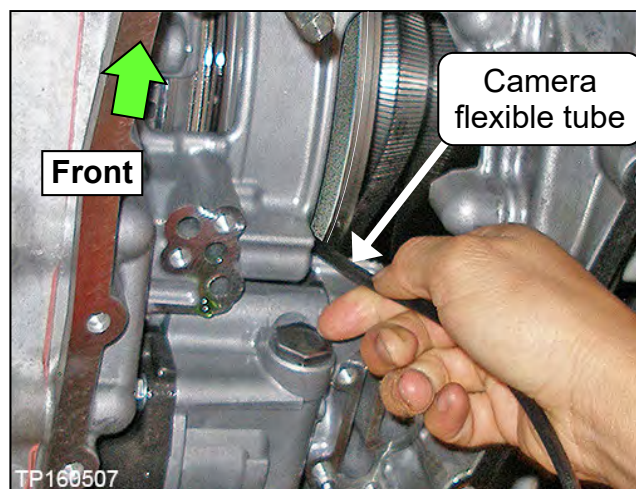

Figure 11

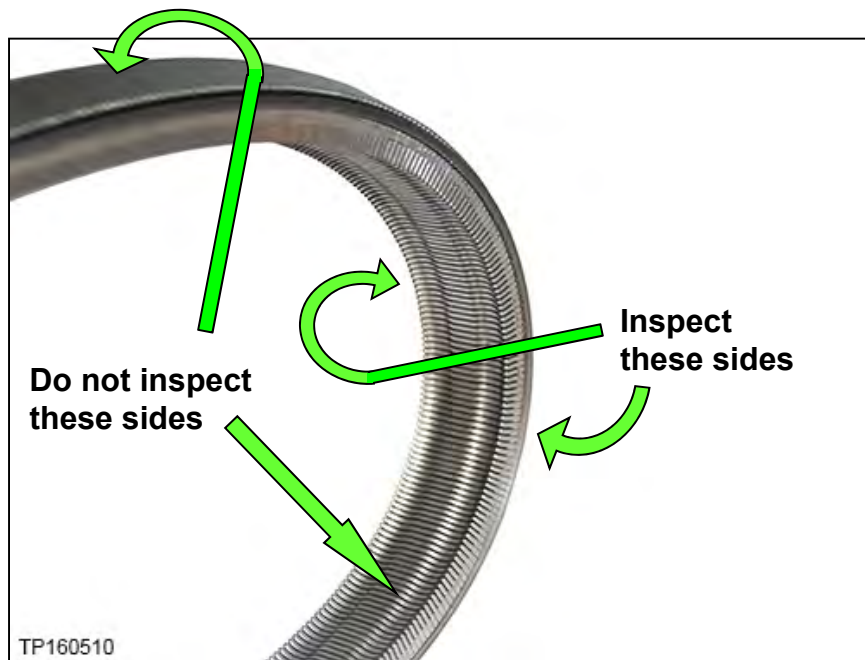

Figure 12

7. Inspect the entire side of the belt by, slowly and carefully, turning the front left tire one full rotation in the forward direction.
 - Holding the borescope with one hand allows for turning the tire with the other hand (see Figure 13).
 - Reference the Figures on pages 14 through 16 for a comparison of an **OK** and **NG** belt condition.



Figure 13

CAUTION: If the tire rotates in the rearward direction, the camera lens may be caught between the belt and pulley.

- If the inspection result is **OK**, inspect the other side of the belt in step 8.
- If the inspection result is **NG**, replace the CVT sub-assembly (page 17), control valve (page 72) and, if applicable, reprogram the TCM (page 79).

8. Insert the camera lens in the second location where shown in Figure 10 and Figure 14, and then perform step 7 again.

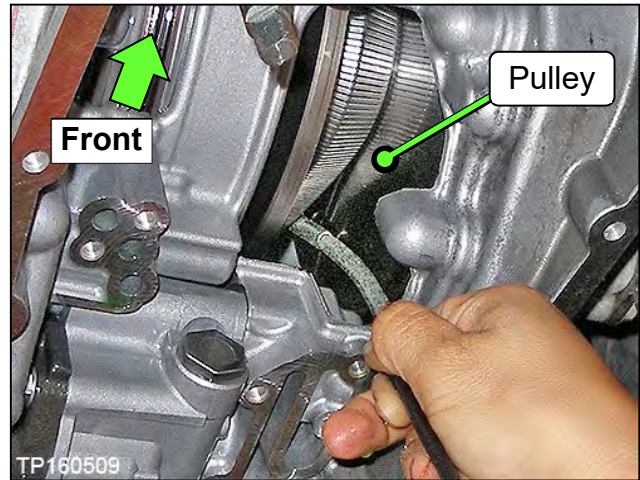

Figure 14

- If the inspection result is **OK** on both sides of the belt, replace the control valve (page 72) and, if applicable, reprogram the TCM (page 79).
- If the inspection result is **NG**, replace the CVT sub-assembly (page 17), control valve (page 72) and, if applicable, reprogram the TCM (page 79).

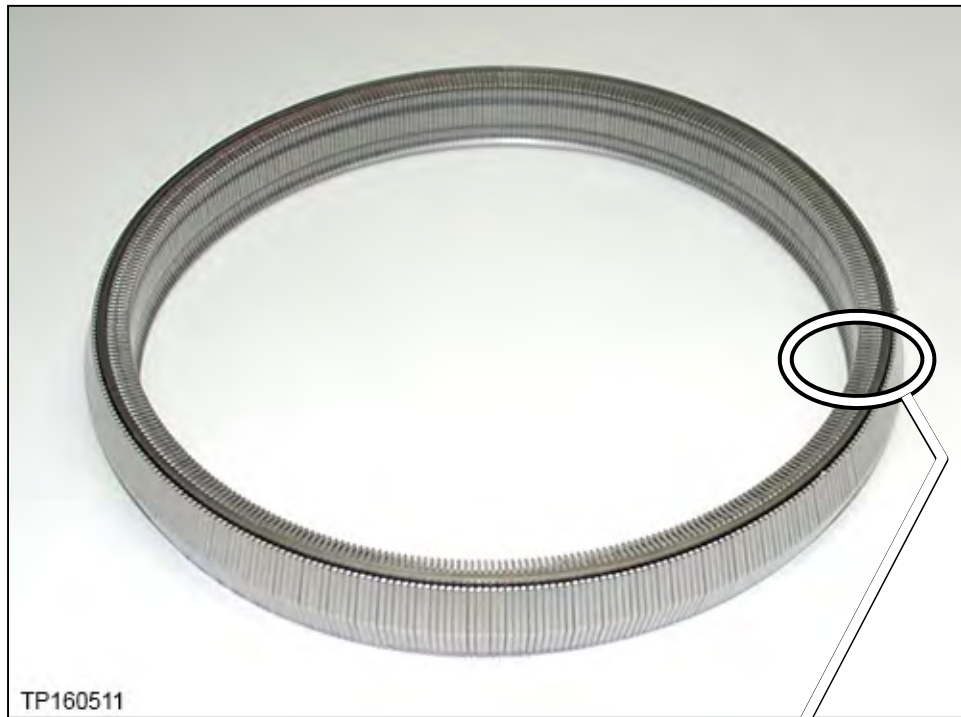

Figure 15: New belt

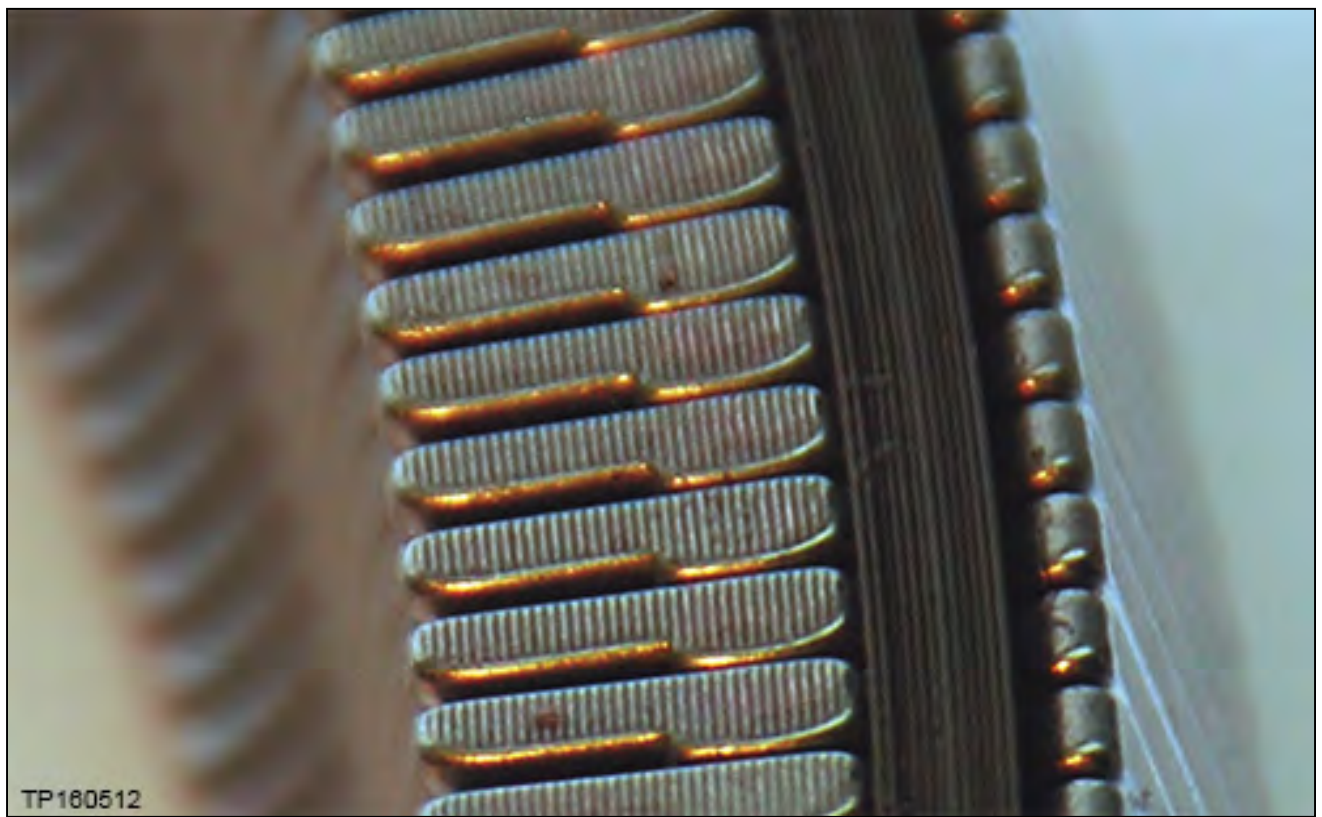

Figure 16: Close-up of section to be inspected

Pictures in Figure 17 and Figure 18 were taken with borescope J-51951.

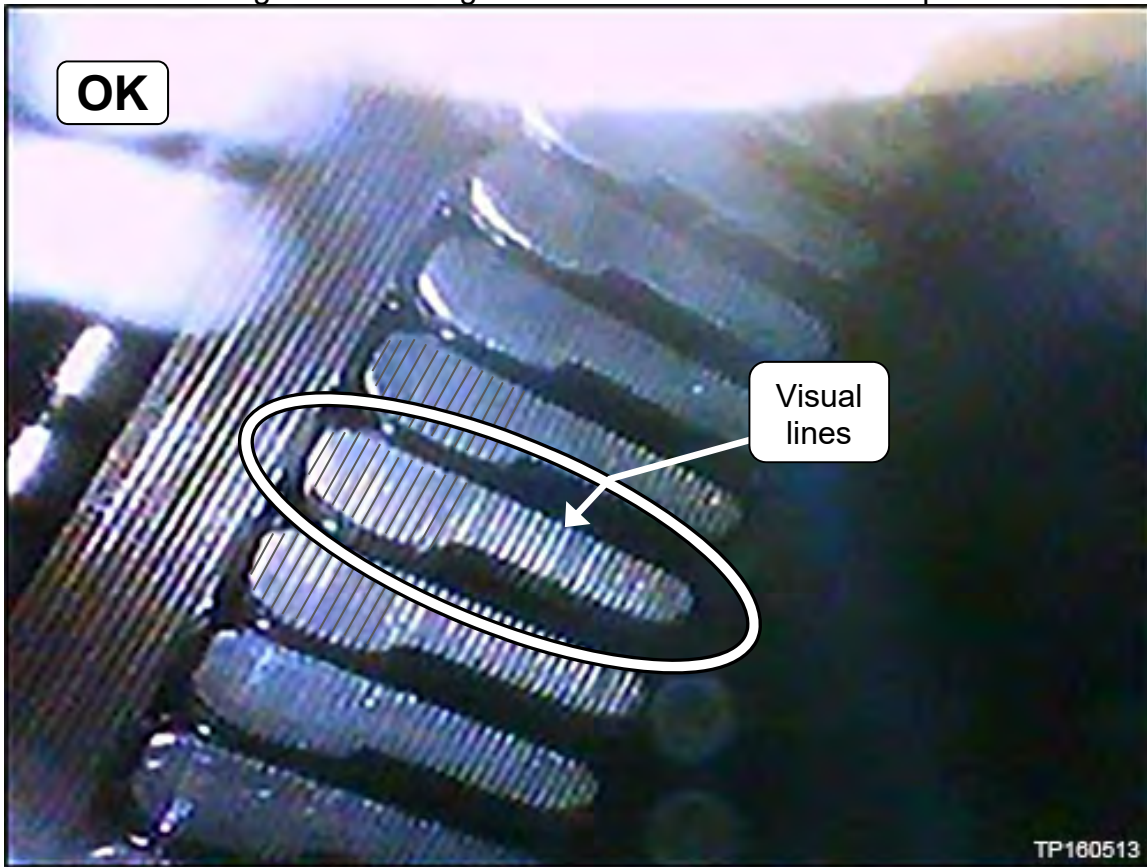

Figure 17: Belt is OK

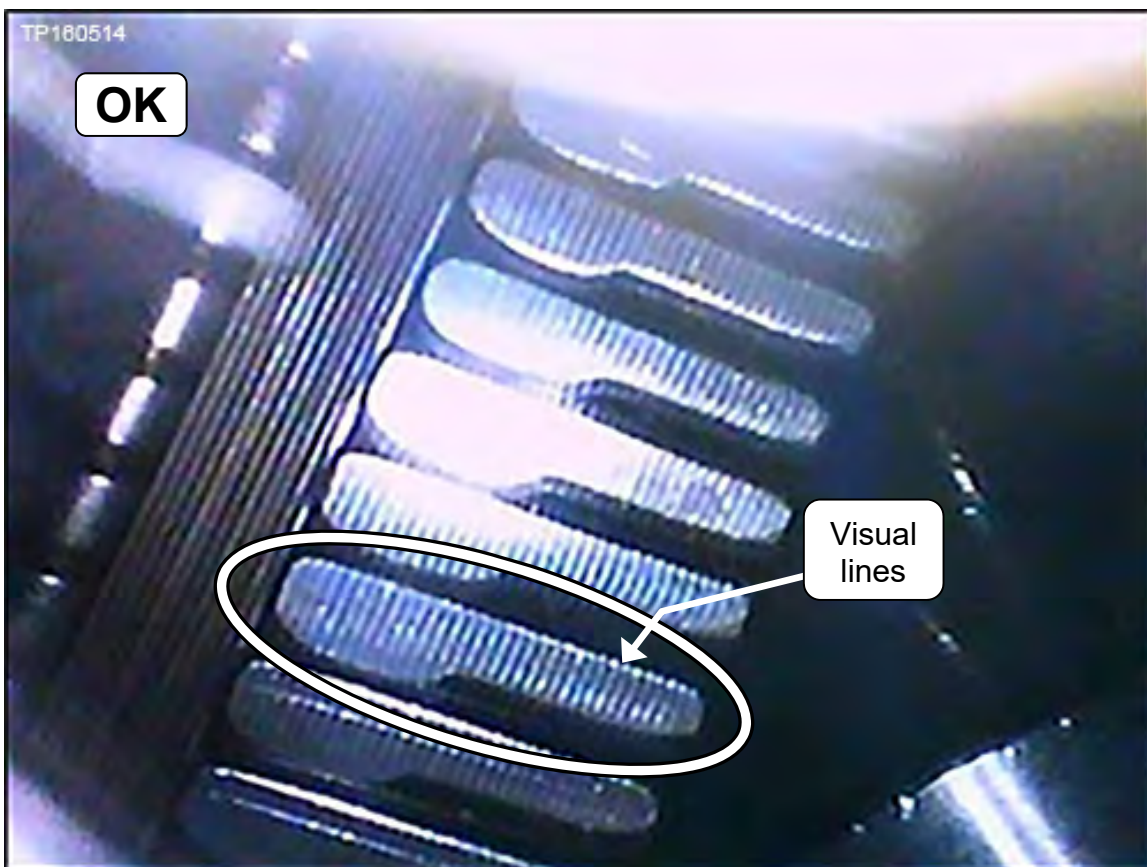

Figure 18: Belt is OK

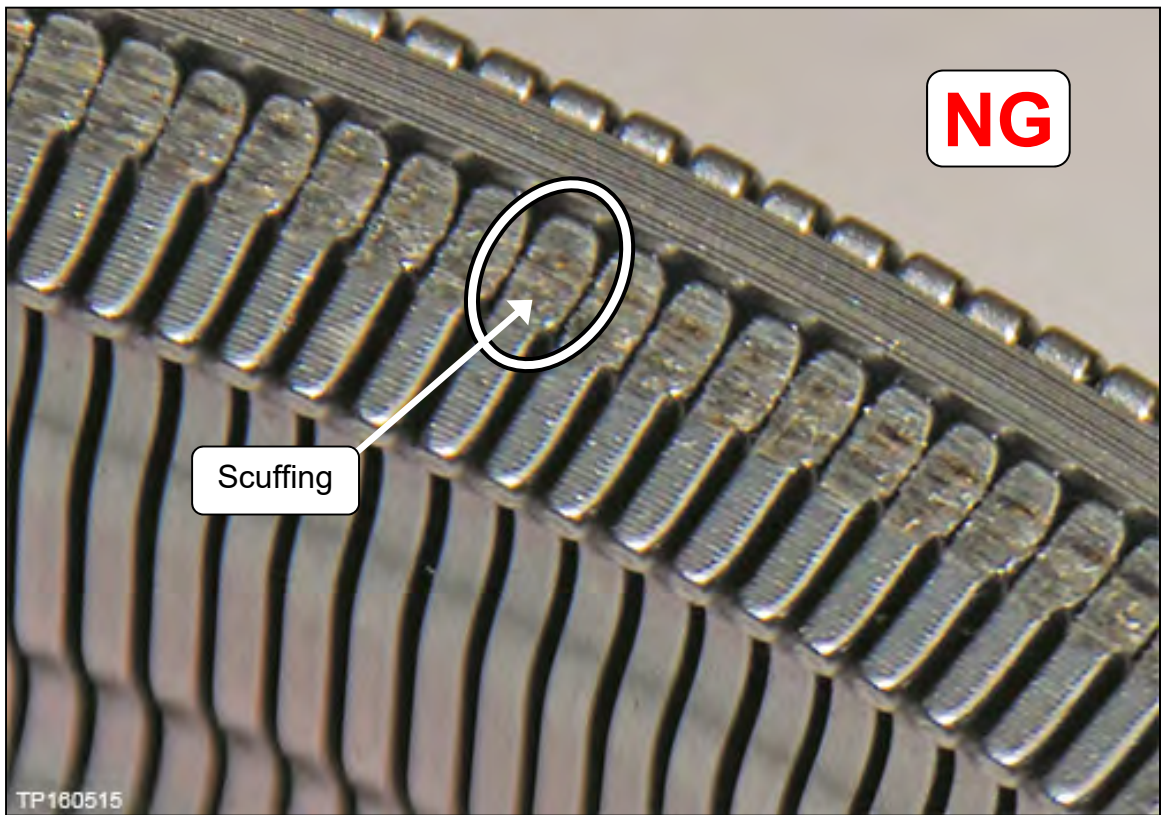

Figure 19: Example of NG belt

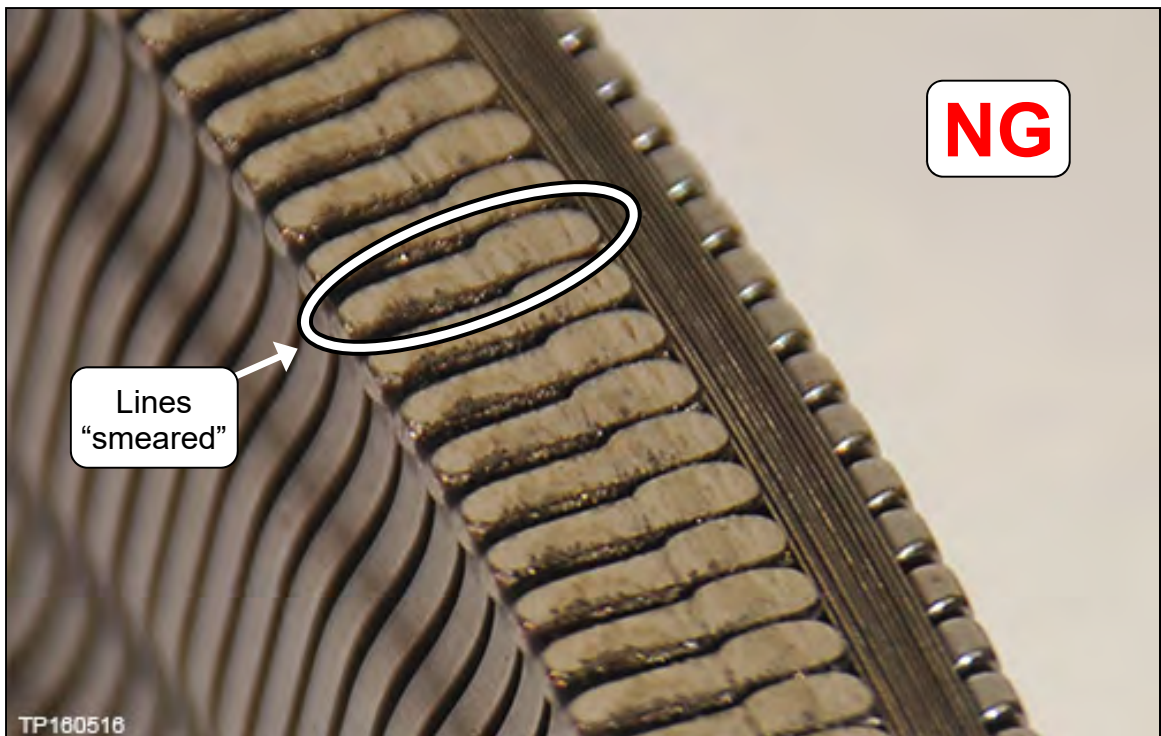

Figure 20: Example of NG belt

Pictures in Figure 21-Figure 23 were taken with borescope J-51951.



Figure 21: Example of NG belt



Figure 22: Example of NG belt



Figure 23: Example of NG belt

CVT Assembly Removal

Overview of Sub-assembly Repair

Steps 1-15 below are an overview of the CVT sub-assembly repair. The procedure for this bulletin continues on the next page with step 9.

1. Apply rust penetrant as necessary to the dowel pins on the converter housing side and sub-assembly side cover
2. Remove the CVT from the vehicle
3. Remove the Converter Housing, Oil Seals, Oil Pump Cover, Oil Pump and Oil Filter
4. Clean the CVT case surfaces
5. Clean the Oil Passages in the CVT Case, Oil Pump Cover, and CVT Filter Area
6. Check initial pulley movement characteristics
7. New Pump Installation
8. Replace the Side Cover – Pulleys and Belt
9. Confirm shift selector movement
10. Recheck new pulley movement characteristics matches that of the original assembly
11. Clutch Total Endplay Adjustment – Thrust Bearing Selection
12. Clean the Converter Housing Passages
13. CVT Reassembly
14. Control Valve Strainer and Pan Installation
15. Install the CVT Assembly

NOTE: For additional information review video # 547: “**CVT Belt and Pulley Replacement**”.

- This video is located under the **TECH TRAINING GARAGE VIDEOS** tab in Virtual Academy.

9. Temporarily install the oil pan gasket and oil pan with four oil pan bolts to corners of the oil pan, hand tight (Figure 24).

NOTE: It is not necessary for the control valve to be installed, a new one will be installed later in the service procedure.

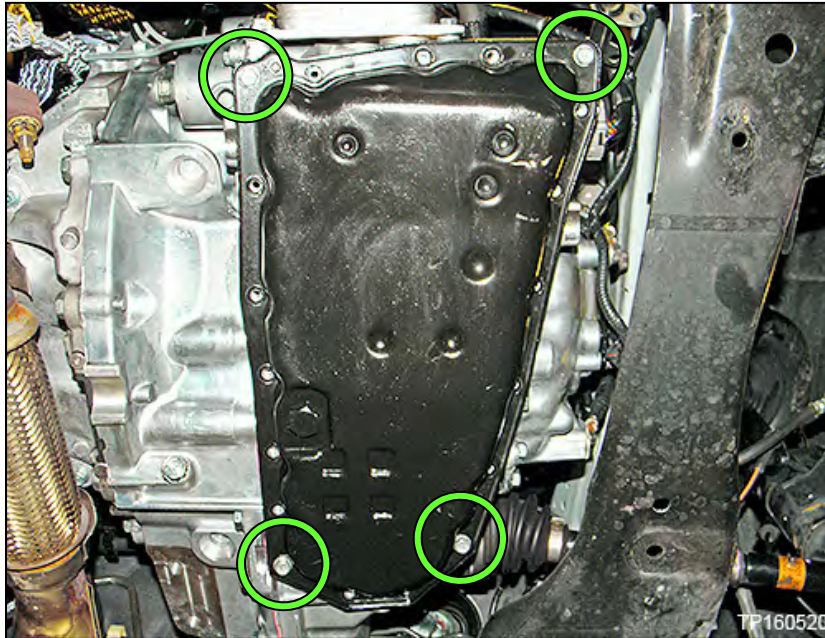

Figure 24

10. Remove the CVT from the vehicle.
 - For CVT removal, refer to the ESM: section **Transaxle & Transmission**.

11. Place the CVT on a workbench with the oil pan side down.
- Use wood or plastic blocks to keep the CVT steady.

CAUTION: Do not deform the oil pan.

12. Remove the torque converter.



Figure 25

13. Drain the CVT.



Figure 26

14. Remove the primary speed sensor.
- IMPORTANT:** The speed sensor will be reused.

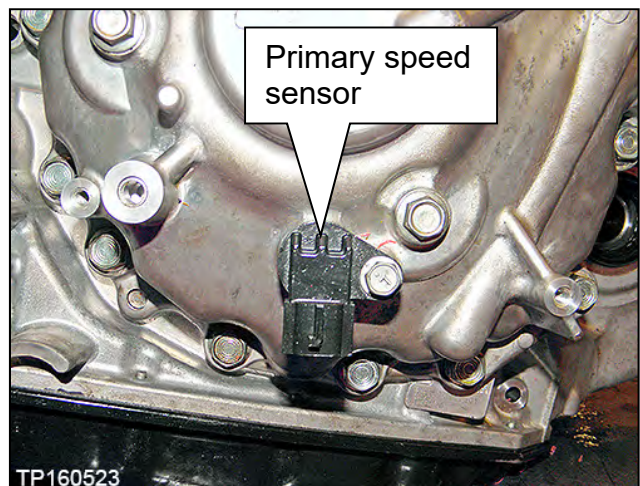

Figure 27

Remove the Converter Housing, Oil Seals, Oil Pump Cover, Oil Pump and Oil Filter

15. Remove all 23 converter housing mounting bolts (see Figure 28).

NOTE:

- These bolts will be replaced with new ones and will not be reused.
- Apply rust remover to the dowel pins if needed.

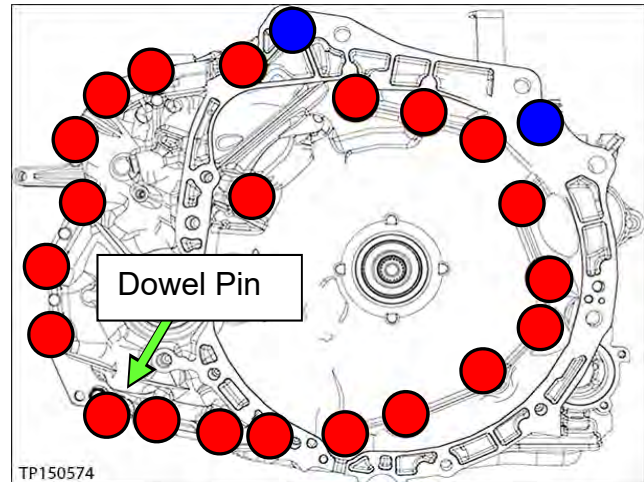

Figure 28

16. Separate and then remove the converter housing from the CVT case.
- Use Slide Hammer J-25721-A and Slide Hammer Bolt J-50255-UPD with J-Hook J-51923 at the cut-out areas similar to the one shown in Figure 29 and Figure 30.

CAUTION: DO NOT use a pry-bar, chisel, etc. to separate the converter housing from the CVT case.

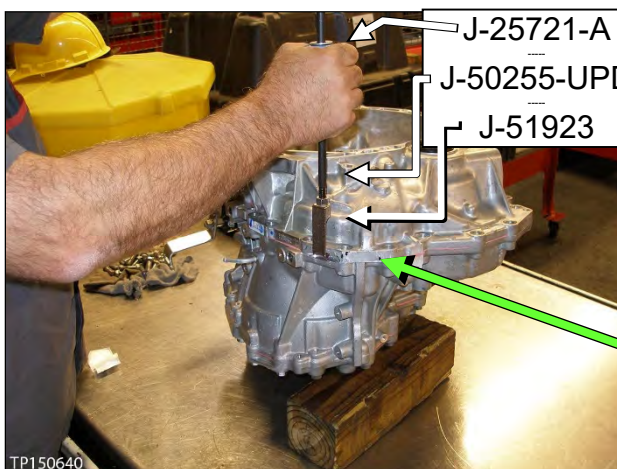

Figure 29

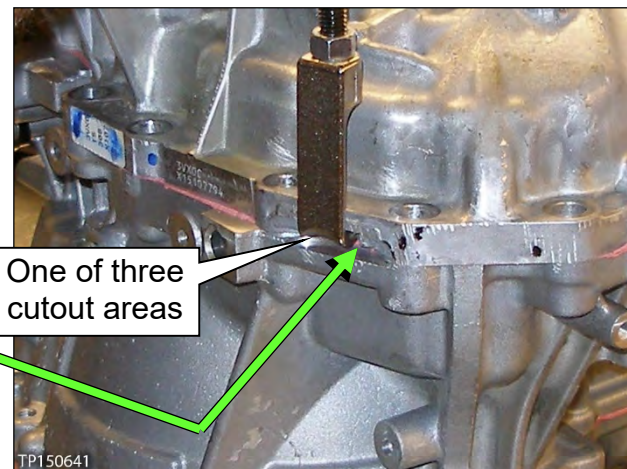

Figure 30

17. Note the location of the pin shown in Figure 31 and Figure 32.

CAUTION: This pin can slip out during movement of the CVT while the converter housing is removed.

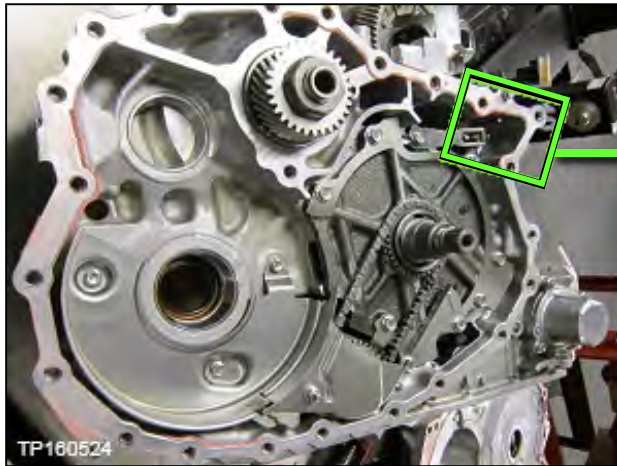

Figure 31

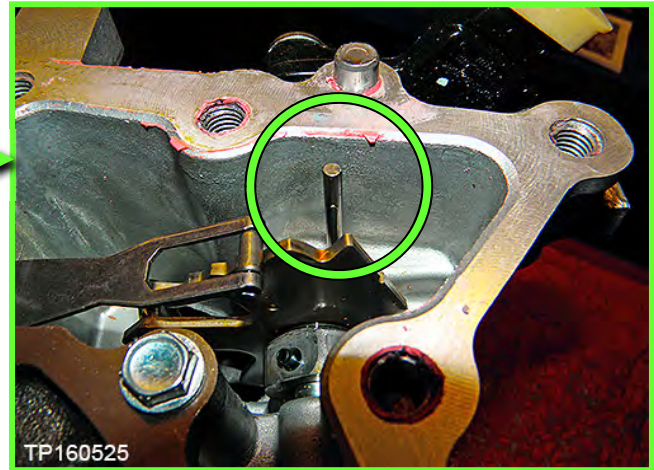

Figure 32

18. Remove the O-ring from the input shaft.

- This O-ring will be replaced with a new one.

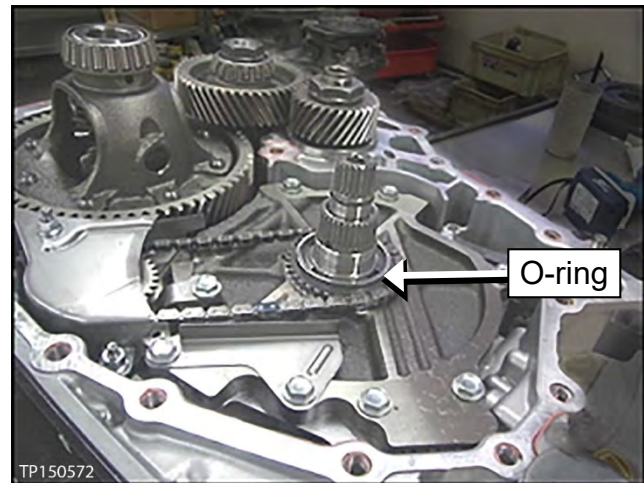

Figure 33

19. Carefully remove the reduction gear assembly (Figure 34).

20. Carefully remove the differential assembly (Figure 35).

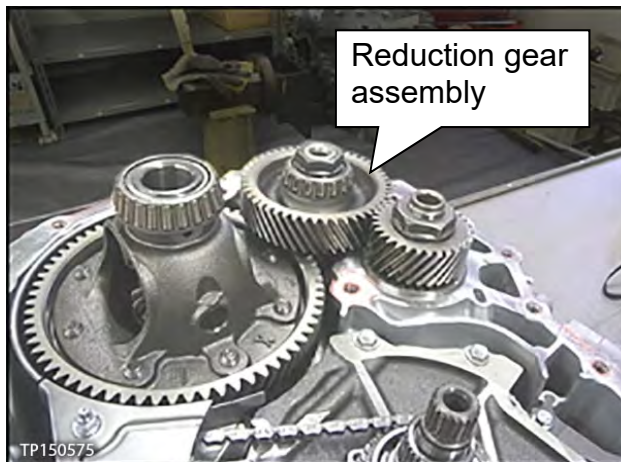

Figure 34

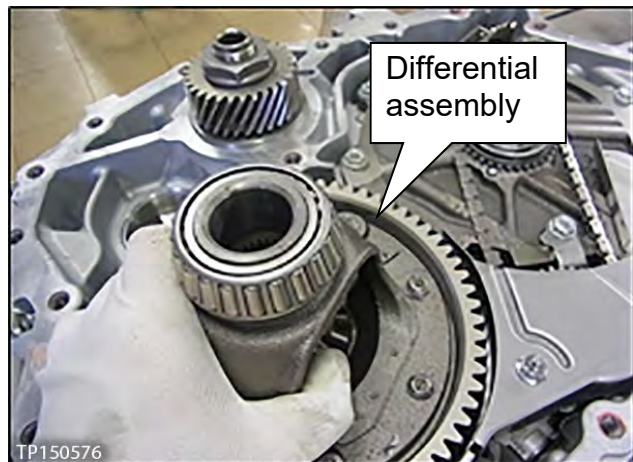

Figure 35

21. Remove the following oil seals using suitable tools:

CAUTION: Be careful not to damage any of the seal bore surfaces.

- a. CVT case differential side oil seal (drive shaft seal).
- See Figure 36.

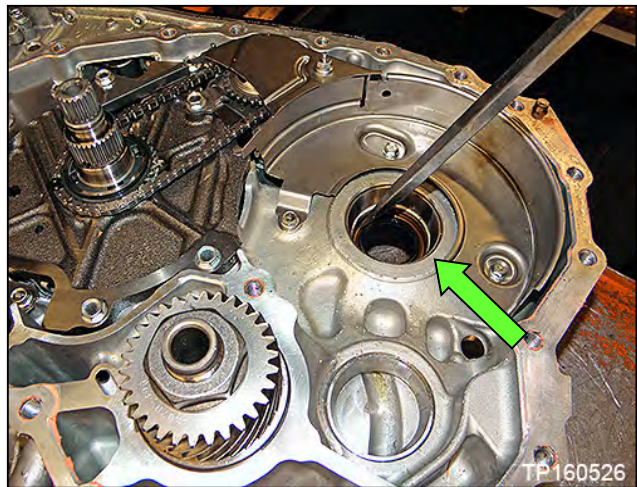

Figure 36

- b. Torque converter seal (Figure 37).

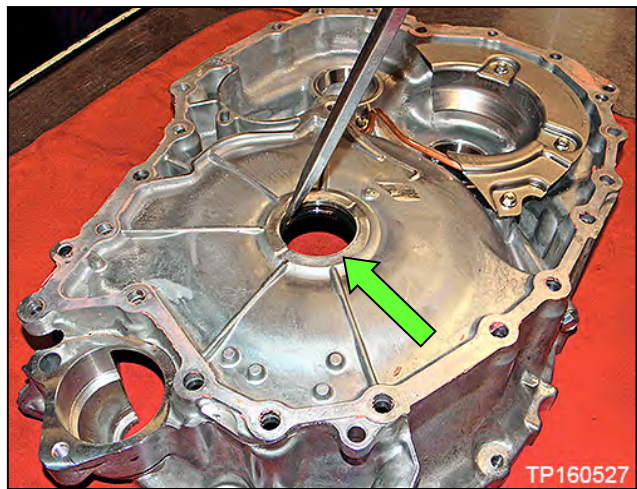

Figure 37

- c. Converter housing differential side oil seal (drive shaft seal).

- See Figure 38.

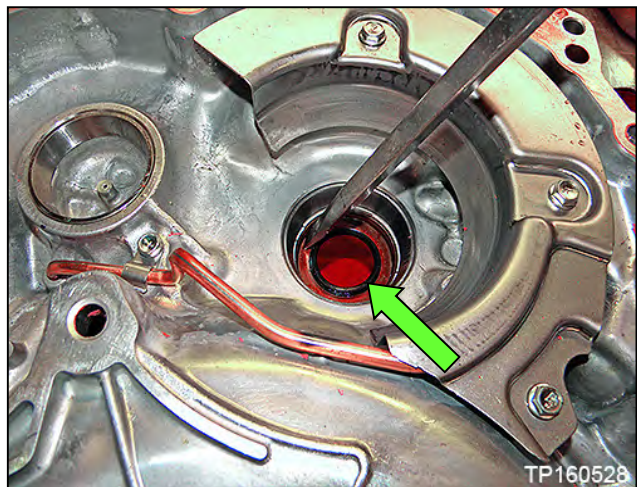

Figure 38

22. Remove the two (2) nuts from baffle plate A, and then remove baffle plate A (see Figure 39).

CAUTION: To avoid rounding off these nuts, it is best to use a 3/8 inch drive 6-pt 10 mm socket.

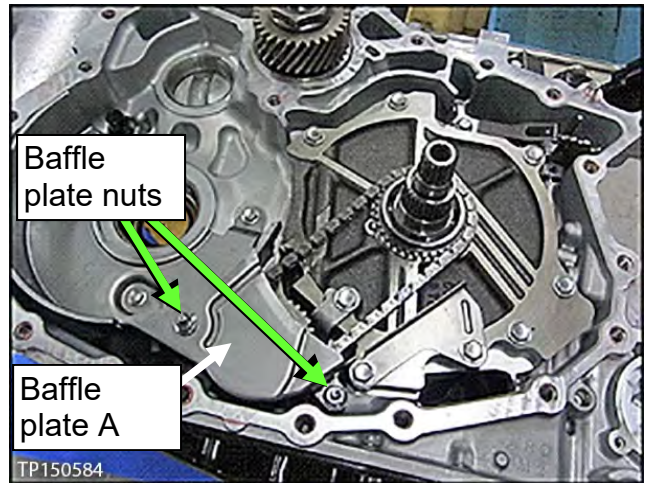

Figure 39

23. Remove the oil pump chain, driven sprocket and drive sprocket as one assembly (Figure 40).

- Spread the snap ring to remove the sprocket (Figure 41).

IMPORTANT: The drive sprocket has a specific top and bottom. Keep the sprockets and chain together after removed.

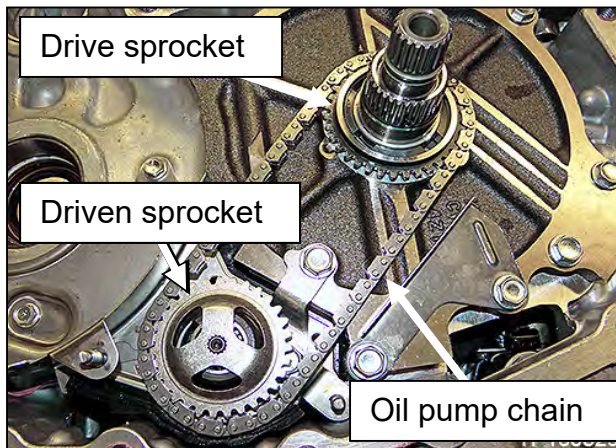

Figure 40

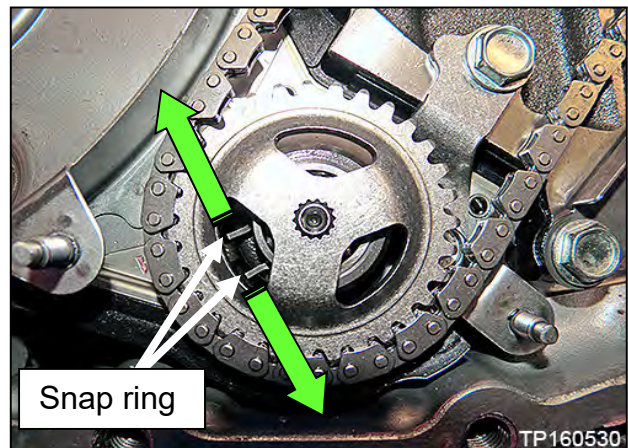

Figure 41

24. Remove the pump cover (dummy cover) thrust washer (Figure 42).
- This thrust washer will be reused.

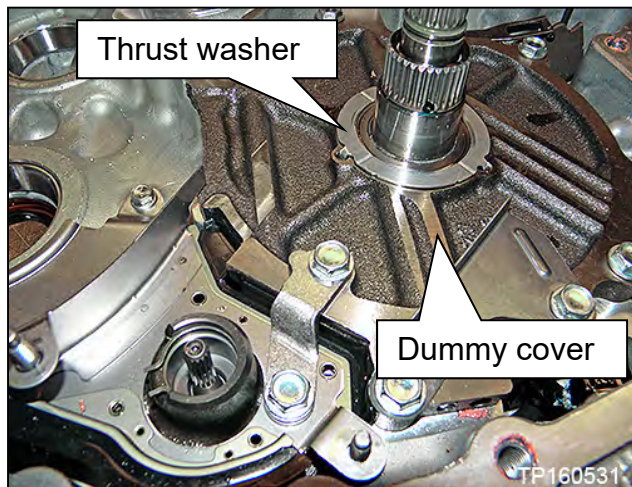

Figure 42

25. Remove the oil pump snap ring (Figure 43).
- Lightly push the ends of the snap ring together, rotate one side upwards while pulling the snap ring towards the pump opening.

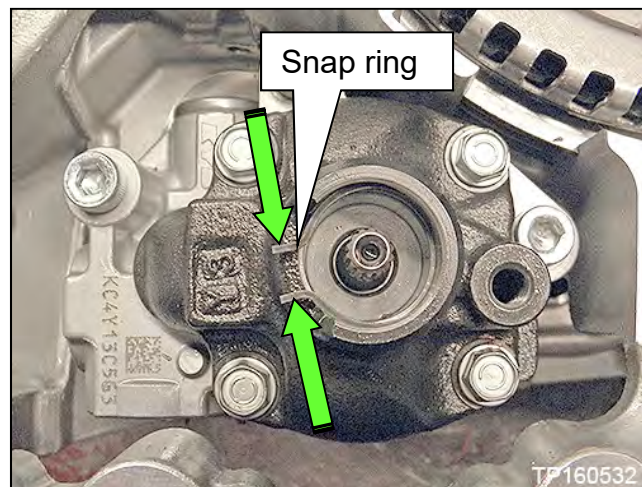

Figure 43

26. Remove the oil pump bracket (Figure 44).
- Retained by two bolts.

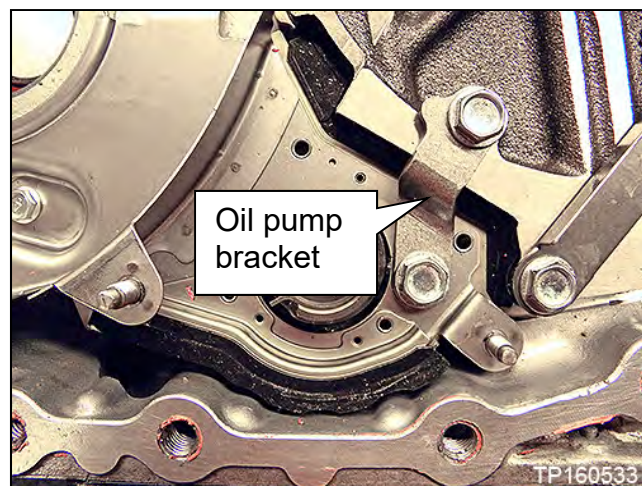

Figure 44

27. Remove the three (3) bolts from baffle plate B, and then remove baffle plate B (Figure 45).

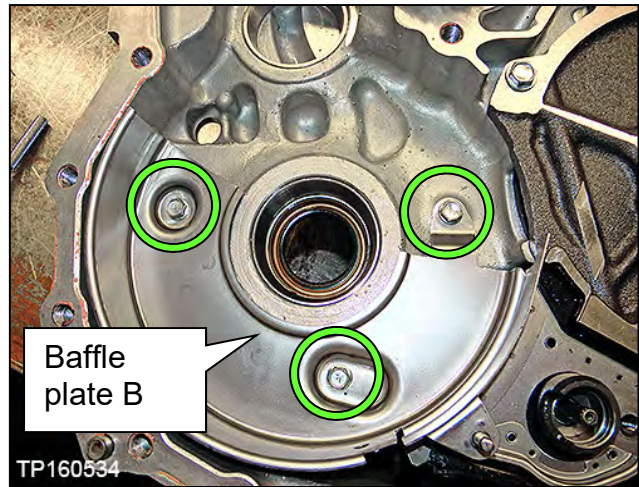

Figure 45

28. Remove the two (2) bolts from baffle plate C, and then remove baffle plate C (Figure 46).

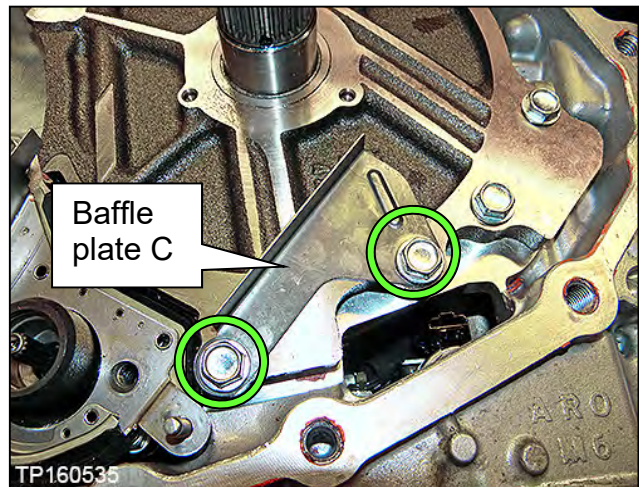

Figure 46

29. Remove the five (5) dummy cover bolts, and then remove the dummy cover. See Figure 47.

NOTE: These bolts will be reused.

IMPORTANT:

- Lift the dummy cover from sides **ONLY**. Do **NOT** lift from the input shaft (Figure 47). This can lift the clutch pack out.
- Do **NOT** remove the lathe cut seals (white seals in Figure 48) from the dummy cover. These seals will be reused.
- **Lathe cut seals must be in their correct positions during final assembly to prevent drivability issues.**

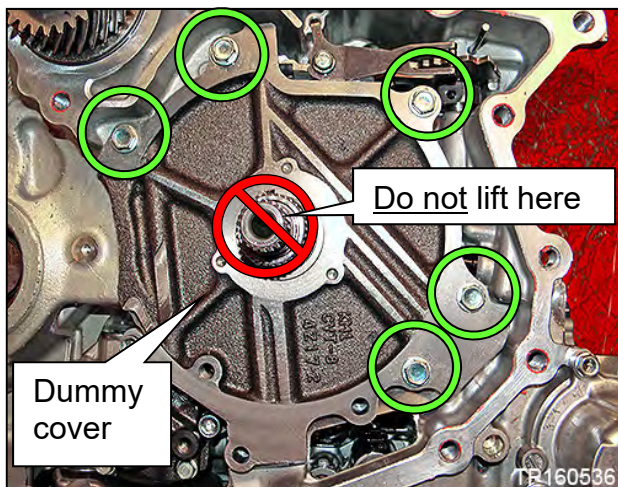

Figure 47

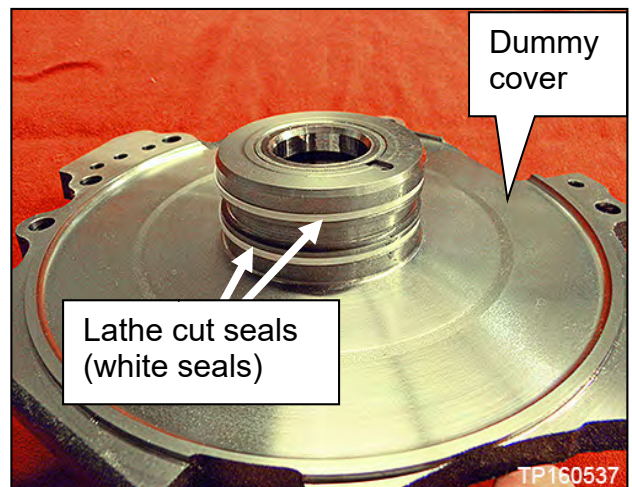

Figure 48

30. Remove the thrust bearing from the clutch assembly bore (Figure 49).

NOTE: Take care when removing the thrust bearing so that the lathe cut seals are not knocked out of their grooves.

IMPORTANT:

- The thrust bearing has two different sides. As the thrust bearing is removed, note the thrust bearing orientation so that the new bearing can be installed in the same orientation.
- This bearing will not be reused.

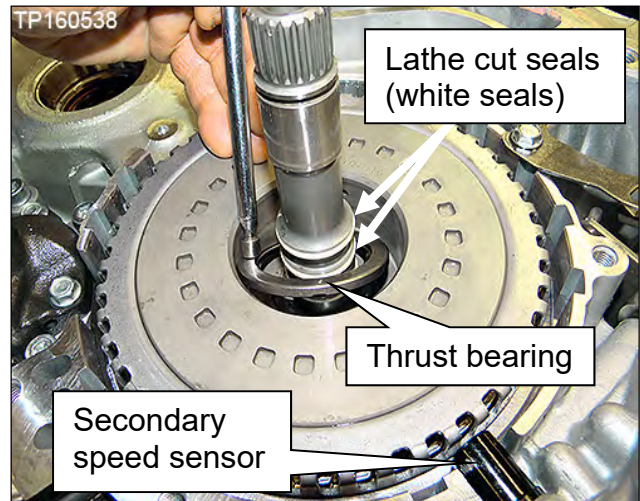

Figure 49

31. Wipe any metallic debris from the face of the secondary speed sensor (Figure 49).

32. Remove the oil pump as follows:

- a. Remove the fitting bolt located above the left rear corner of the oil pan gasket surface (Figure 50).

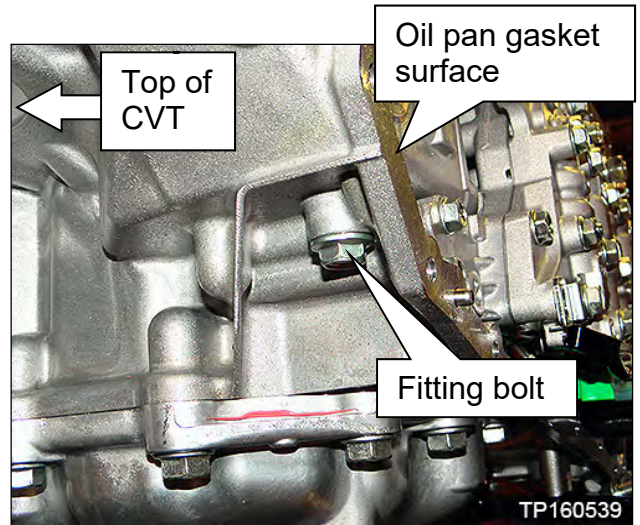

Figure 50

- b. Remove the three (3) oil pump Allen®-head bolts, and remove the oil pump (Figure 51).

NOTE:

- Do NOT discard the Allen®-head bolts. These bolts will be reused.
- A new oil pump will be installed later in this bulletin.

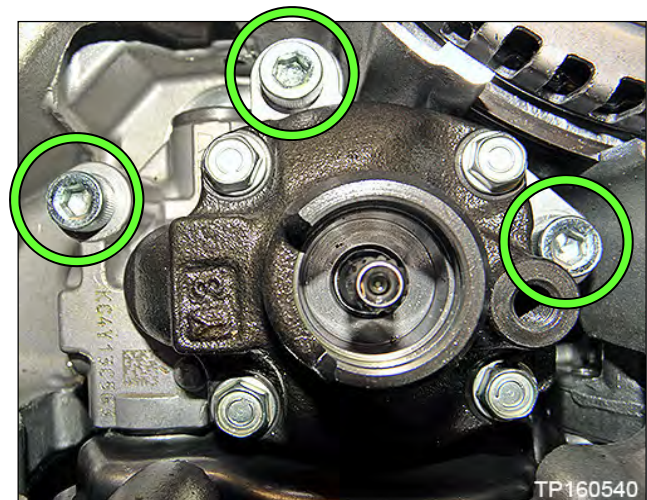

Figure 51

33. Remove the CVT fluid filter as follows:

- a. Remove the four (4) bolts and then remove the CVT fluid filter cover (Figure 52).

NOTE: These bolts will be reused.

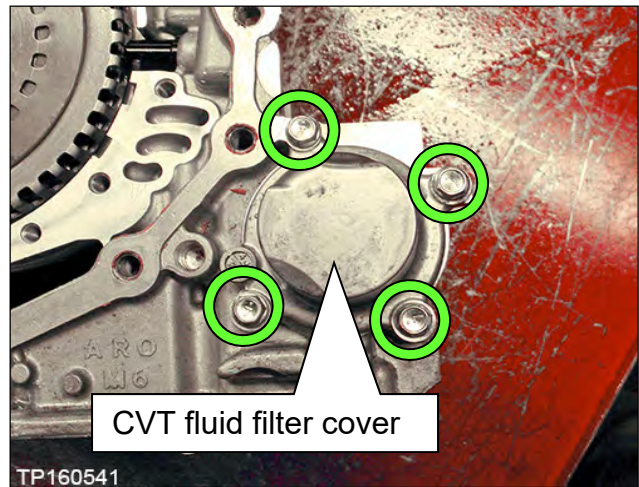

Figure 52

- b. Remove the CVT fluid filter with grommet seal and O-ring seal (Figure 53).

- Discard the oil filter and seal. They will be replaced.
- The grommet seal is fitted to the bottom end of the filter and is included with the replacement filter (Figure 54).

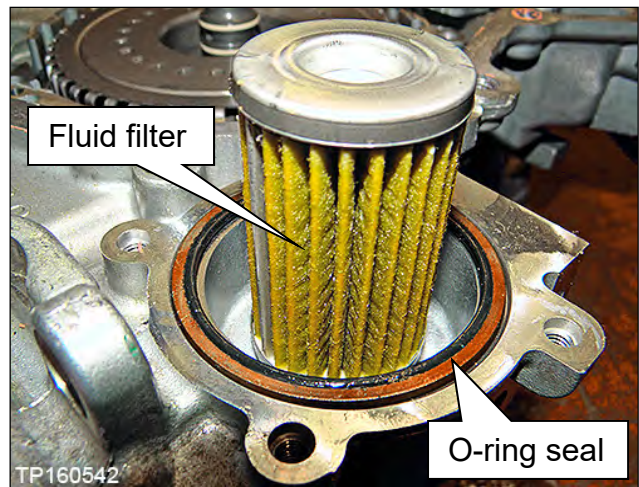

Figure 53



Figure 54

Clean the CVT case surfaces

34. Thoroughly clean the mating surfaces of the CVT case and torque converter housing.
- A plastic scraper can be used.

CAUTION:

- **DO NOT** use sanding discs, similar abrasive tools, or metal blades.
- Use brake cleaner or equivalent solvent and lint-free towels only.
- Make sure brake cleaner or solvents used are compatible with local regulations.
- Prevent debris from entering in the CVT.
- Make sure rust and debris have been cleaned off of dowel pins and receiving holes (Figure 55 and Figure 56).

35. Clean the dowel pins and dowel pin receiving holes of any rust and debris (Figure 55 and Figure 56).

NOTE: Use a small wire brush or similar tool at the inside surface of dowel pin holes. **DO NOT SCRAPE CVT CASE** mating surfaces.



Figure 55



Figure 56

Clean the Oil Passages in the CVT Case, Oil Pump Cover, and CVT Filter Area

In the following steps:

- Brake cleaner or a suitable cleaning solvent and compressed air will be used to clean out oil passages in the CVT assembly.
- Make sure the brake cleaner or solvents are compatible with local regulations.

WARNING: Wear eye / face protection when using compressed air and cleaning fluids.

CAUTION: Regulate air pressure up to a maximum of 75 PSI.

36. Clean the area where the CVT fluid filter fits (Figure 57).
 - Make sure the old filter grommet seal is removed.
37. Clean the fluid passages to and from the filter (Figure 57).

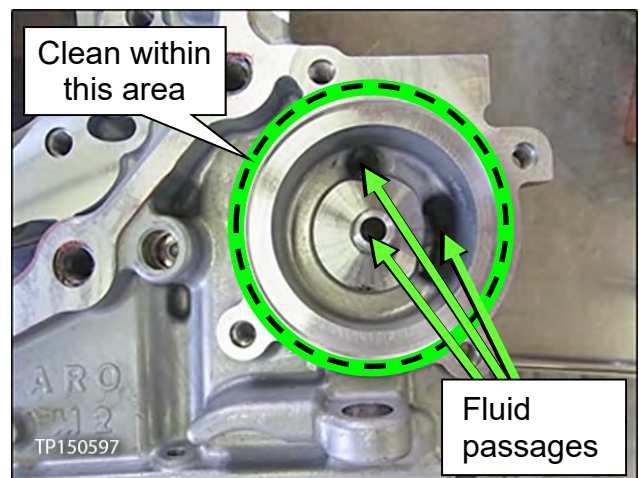

Figure 57

38. Use brake cleaner in all oil passages of the CVT case where shown in Figure 58 and Figure 59.

- Do not spray brake cleaner into the clutch pack.

39. Apply compressed air in the same passages.

NOTE: Do not stand in front of the passages while using compressed air.

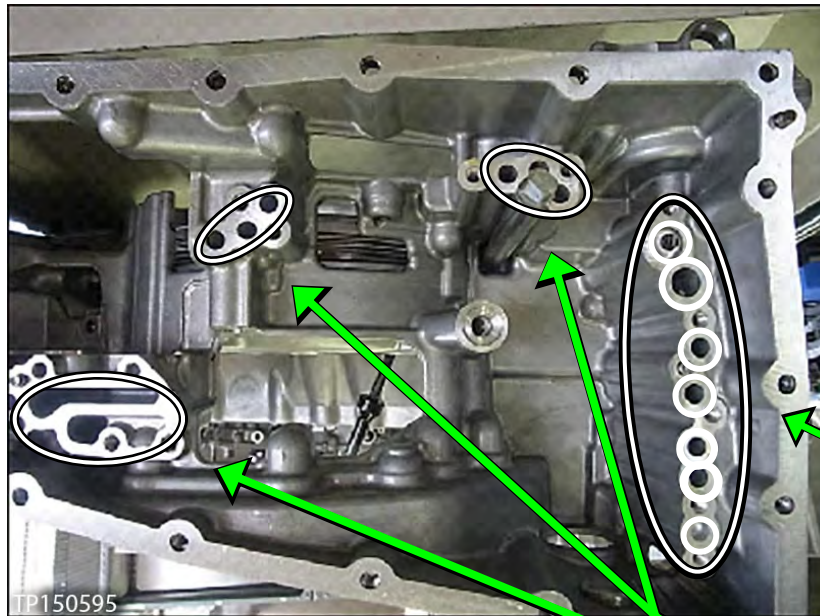

Figure 58

Apply cleaner, and then 75 PSI maximum air pressure in these passages.

Air pressure comes out these passages.

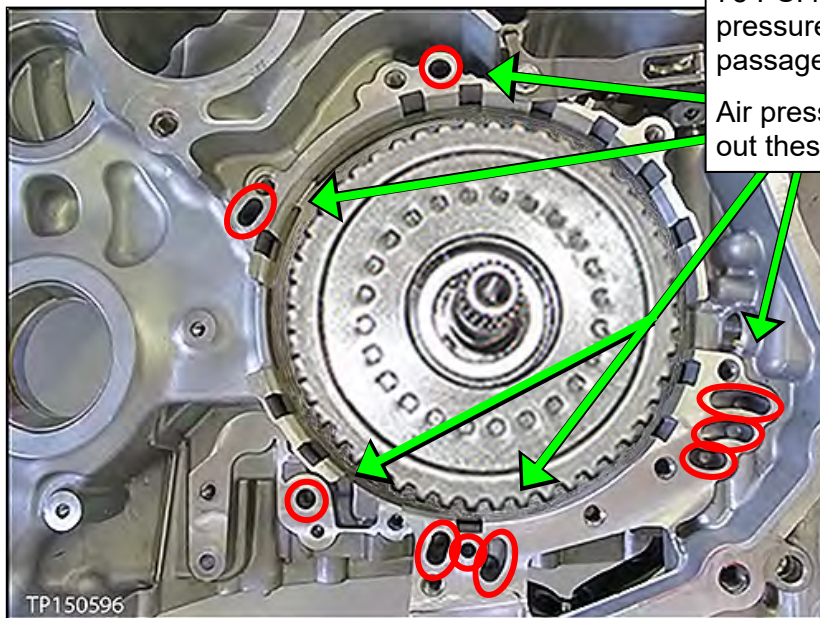

Figure 59

40. Temporarily install the fluid filter cover.

New Oil Pump Installation

IMPORTANT: For the following service procedures a **PARTS KITS REFERENCE TABLE** is provided on page 95.

- Use the check off column on the left to ensure the correct new part is installed at each step, and then attach it to the repair order.

41. Install the new oil pump using three original Allen®-head bolts (Figure 60).

NOTE:

- Finger tighten the Allen®-head bolts at this time.
- The oil pump kit includes a new oil pump, O-ring, and snap ring.

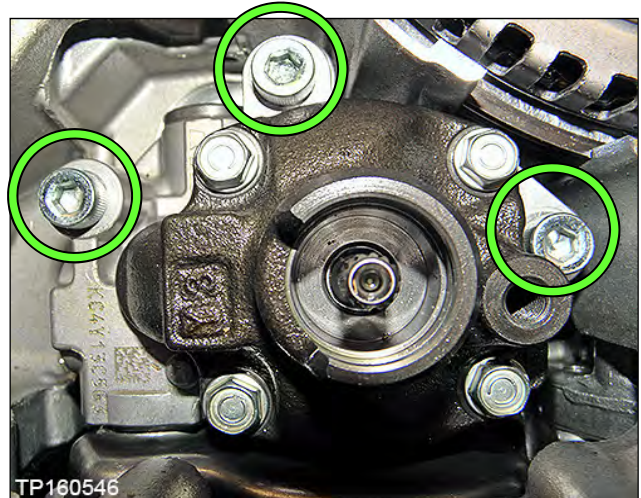

Figure 60

42. Place a new O-ring on the fitting bolt, and then coat the O-ring with CVT fluid (Figure 61).

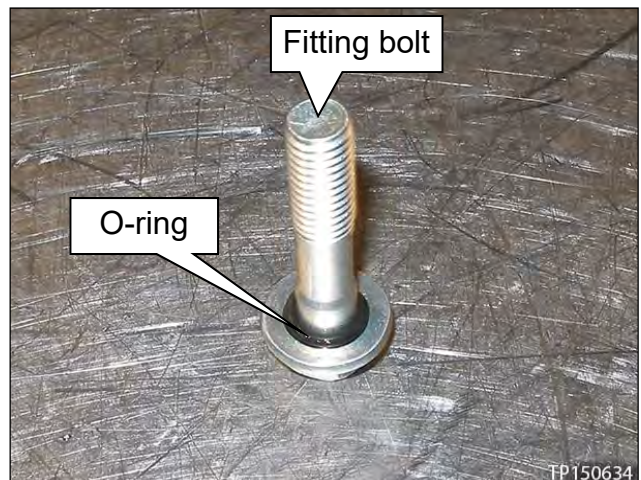

Figure 61

43. Install the fitting bolt finger tight (Figure 62).

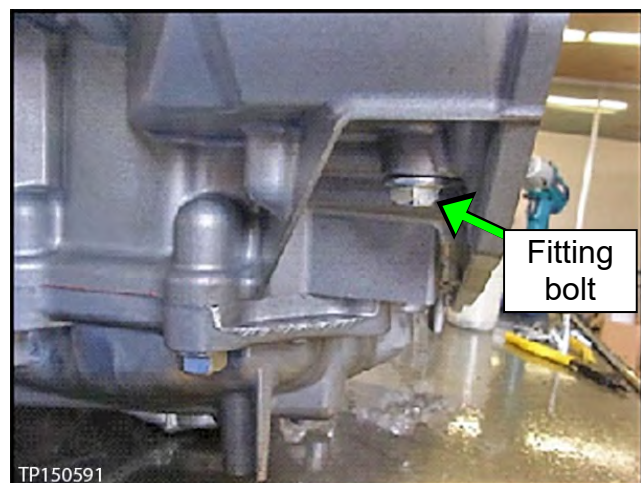

Figure 62

44. Torque the three (3) Allen®-head bolts and fitting bolt.
- Allen®-head bolt torque: 17.6 – 20.6 N•m (1.79 – 2.1 kg-m, **13.0 – 15.2 ft-lb**)
 - Fitting bolt torque: 26.0 – 30.0 N•m (2.65 – 3.06 kg-m, **19.2 – 22.1 ft-lb**)

45. Install the new snap ring (Figure 63).

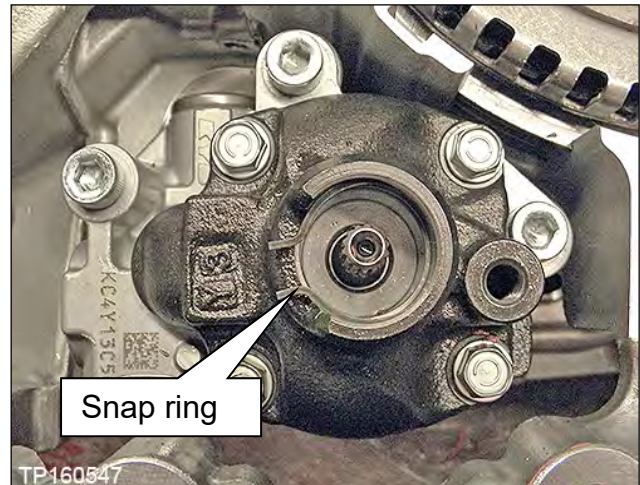

Figure 63

Replace the Side Cover – Pulleys and Belt (sub-assembly)

Review video # 547: “CVT Belt and Pulley Replacement” and fast forward to minute marker 3:14. This video is located under the **TECH TRAINING GARAGE VIDEOS** tab in **Virtual Academy**.

46. Temporarily install the dummy cover with three (3) bolts, finger tight (Figure 64).

IMPORTANT:

- Do not install the thrust bearing to the clutch assembly bore at this time.
- If the cover does not sit flush, continue to step 47 for **Dummy Cover Troubleshooting**. Otherwise, skip to step 54.

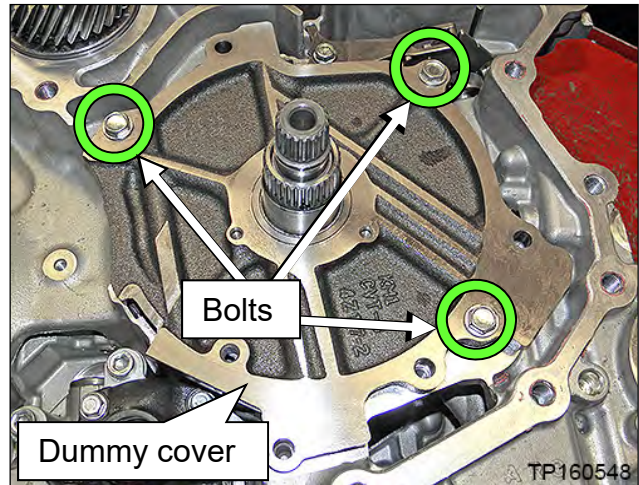

Figure 64

Dummy Cover Troubleshooting

47. If the dummy cover does not sit flush, the clutch pack may not be fully seated.

- Figure 65 shows the clutch pack fully seated.
- The clutch pack is not fully seated if it is not below the surface that the dummy cover bolts to.
- Use the instructions below to fully seat clutch pack.

NOTE: Always handle the clutch pack by the input shaft.

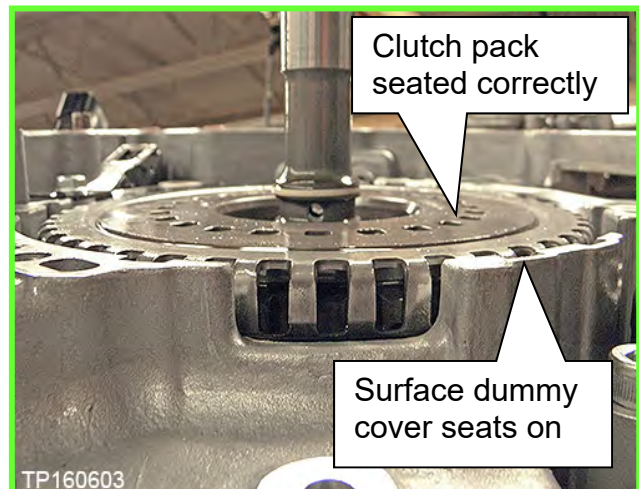

Figure 65

48. Remove the dummy cover.

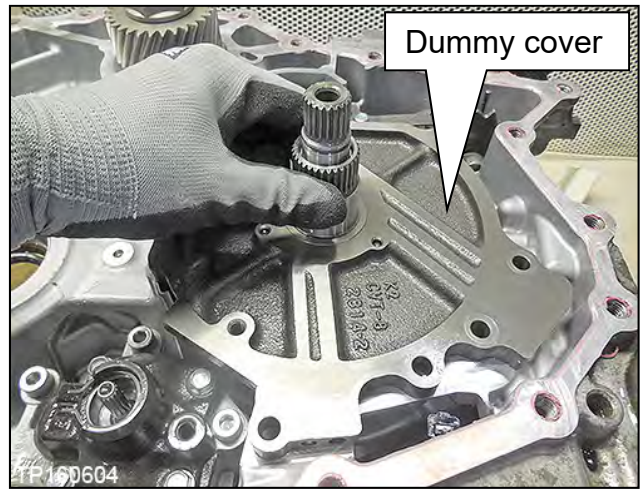

Figure 66

49. Pull up the clutch pack by the input shaft to remove the entire clutch pack.
- Make sure the O-ring is not installed at this time, or it could be damaged during reassembly.

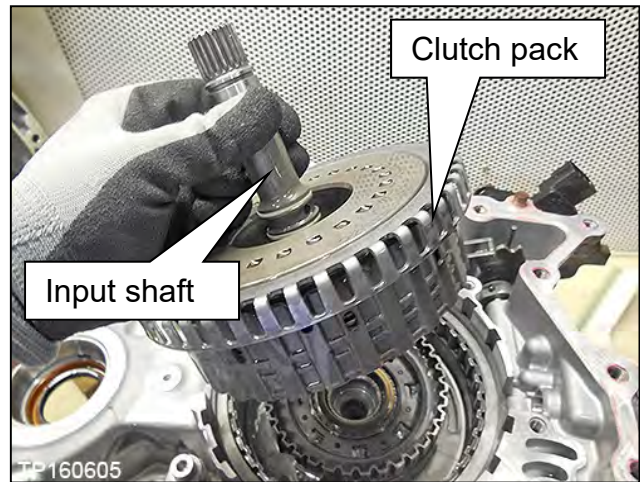

Figure 67

50. Using an appropriate tool, gently align the layers of the clutch pack.
- Bottom of the clutch pack shown in Figure 68.

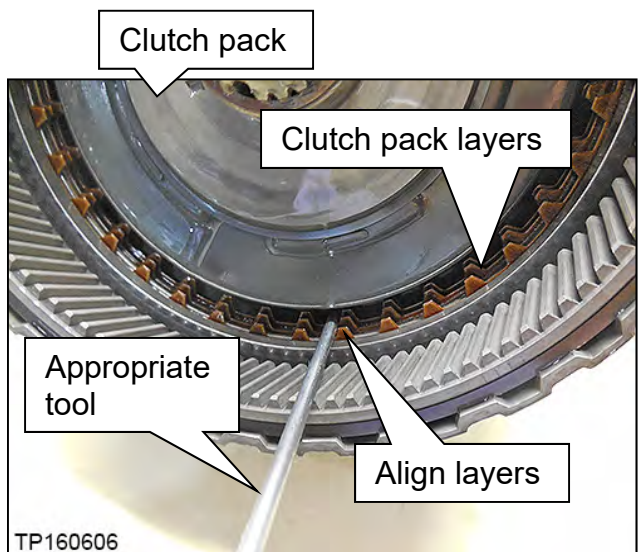

Figure 68

51. Re-insert the entire clutch pack while holding the input shaft.
52. Gently jiggle the input shaft until the clutch pack seats below case lip.
 - If the clutch pack does not seat, rotate back and forth from the input shaft and jiggle.
 - If the clutch pack still does not seat, repeat from step 49.

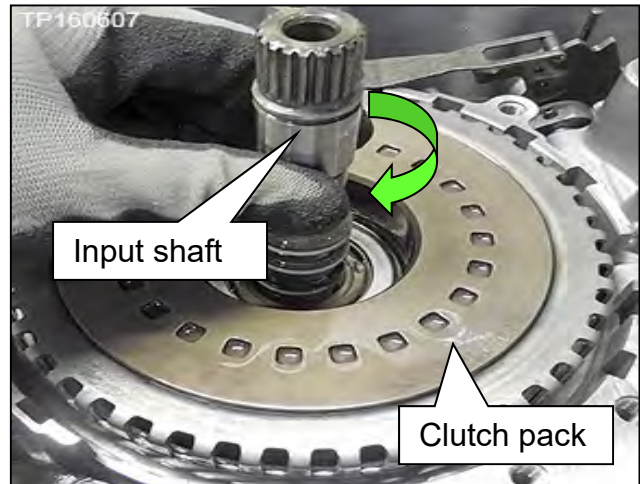

Figure 69

53. Return to step 46.

54. Temporarily install the converter housing onto the CVT case with three (3) bolts finger tight (Figure 70).

IMPORTANT: When fitting the CVT case surfaces, DO NOT use the bolts to draw in the case halves. Make sure the case surfaces are flush and have no gaps prior to installing the bolts.

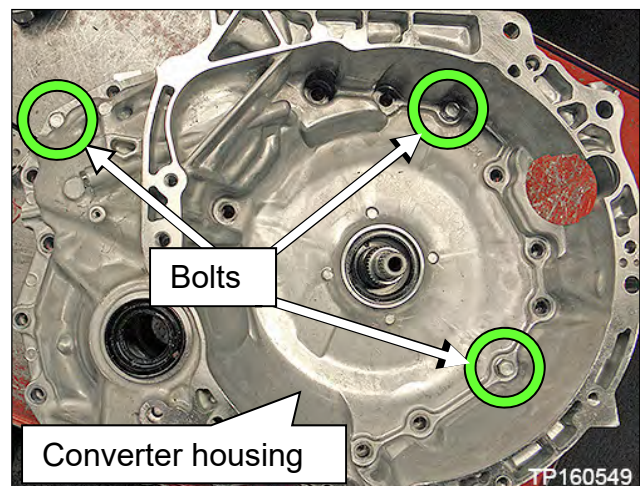

Figure 70

55. Rotate the CVT case so that the converter housing faces down and side-cover faces up.
- CVT lifter bracket J-51595 and CVT Lifting Eye/Swivel Assembly J-51595-1 can be used for this step. See Figure 72.

CAUTION:

- Do not hit the manual shaft (Figure 71) while rotating the CVT; the manual shaft is longer than the oil pan mating surface. Use plastic / wooden blocks to support as needed.
- Note the location of the terminal connector harness. Do not pinch the terminal connector harness between the CVT case and work bench or supporting blocks.

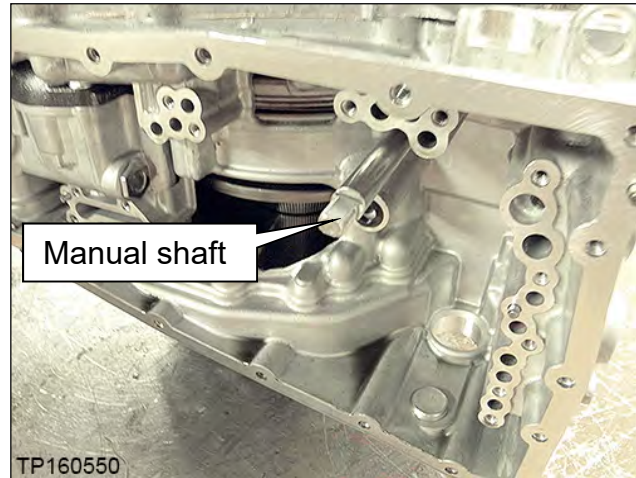

Figure 71

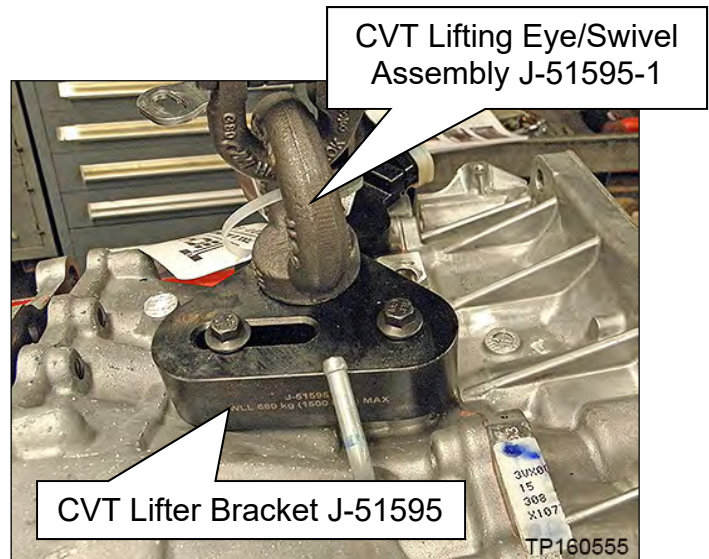

Figure 72

56. Rotate the primary pulley by hand to check the pulley's rotational characteristics.

IMPORTANT: Remember the pulley's rotational characteristics. This will be used as a reference after the new side cover pulleys and belt sub-assembly (sub-assembly) have been installed.

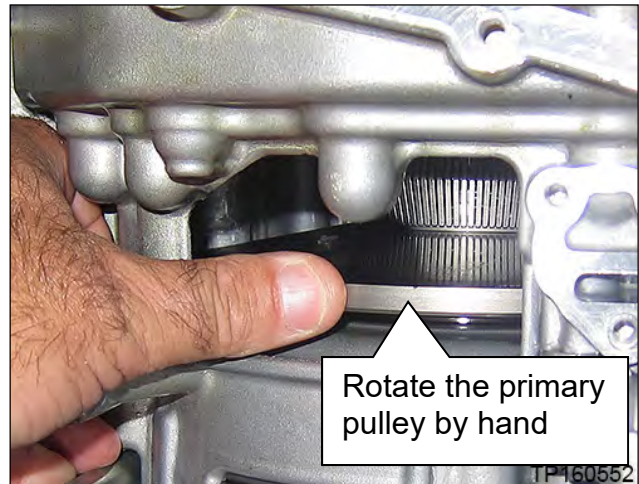

Figure 73

WARNING: Do not place fingers between the pulley and the CVT case.

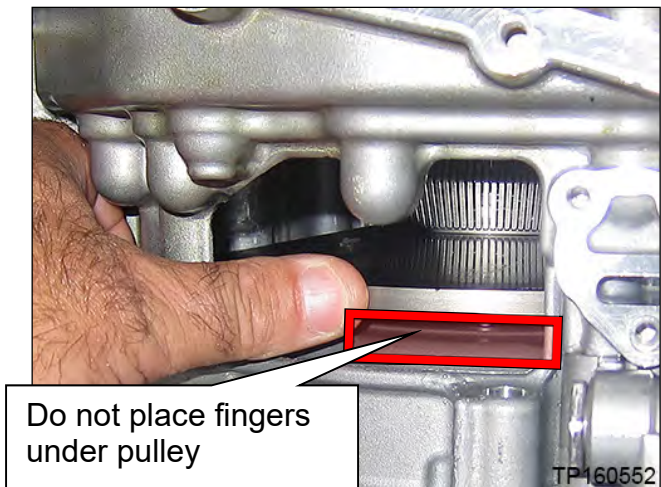

Figure 74

57. Remove the nineteen (19) side cover fixing bolts (Figure 75).
- These bolts will be replaced with new ones and will not be reused.

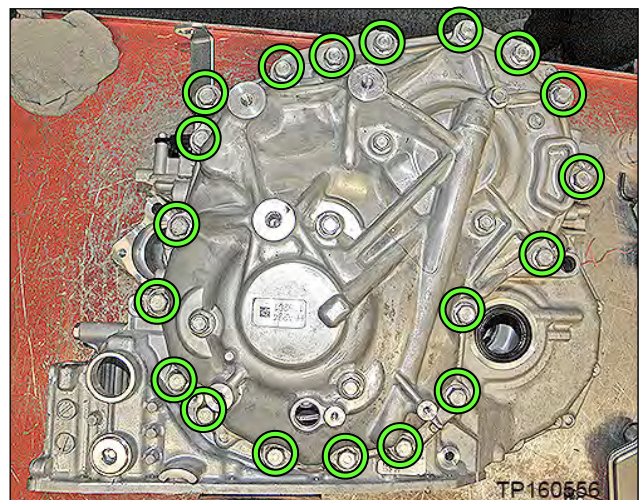

Figure 75

NOTE: When working with the sub-assembly install, uninstall, and bracket attachment, it is critical that the CVT and sub-assembly are level. If not level, the pulleys and bearings can sit slightly at an angle and will hinder installation.

CAUTION: Always handle the CVT and component assemblies carefully and with the appropriate lifting tools.

58. Remove the six (6) pulley bracket bolts.

- These bolts will be reinstalled to the original pulley and belt sub-assembly.

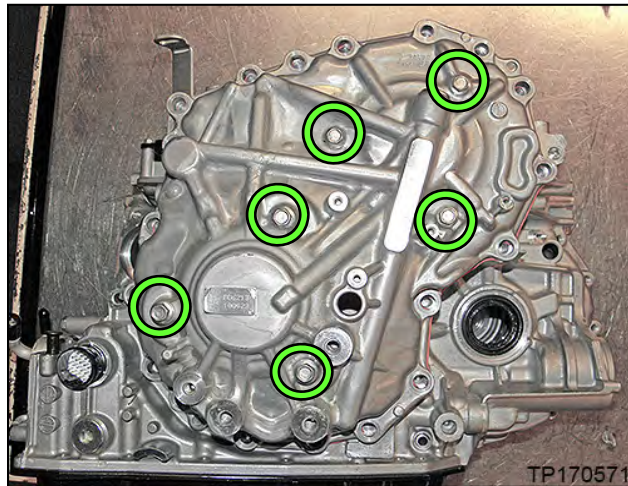

Figure 76

59. Attach CVT Lifting Fixture J-52082 with spacers J-52082-2 to the side cover as shown in Figure 77 on the next page.

NOTE: Install and tighten by hand only.

- a. Loosen all of the wing-nut bolts on the Lifting Fixture.
- b. Confirm that three (3) spacers (# J-52082-2) are present between the longer legs and triangle bracket as shown in Figure 77.
- c. Install the Lifting Fixture to the CVT case at the six (6) bolt holes shown in Figure 76.
- d. Tighten the wing-nut bolts on the Lifting Fixture finger tight in the following order:
 - 1) Tighten the lower six (6) wing-nut bolts.
 - 2) Tighten the two (2) joint to triangle brackets.
 - 3) Tighten the top two (2) wing-nut bolts, and then proceed to step 60 on the next page.

CAUTION: Do not cross thread the bolts when attaching to the CVT side cover.

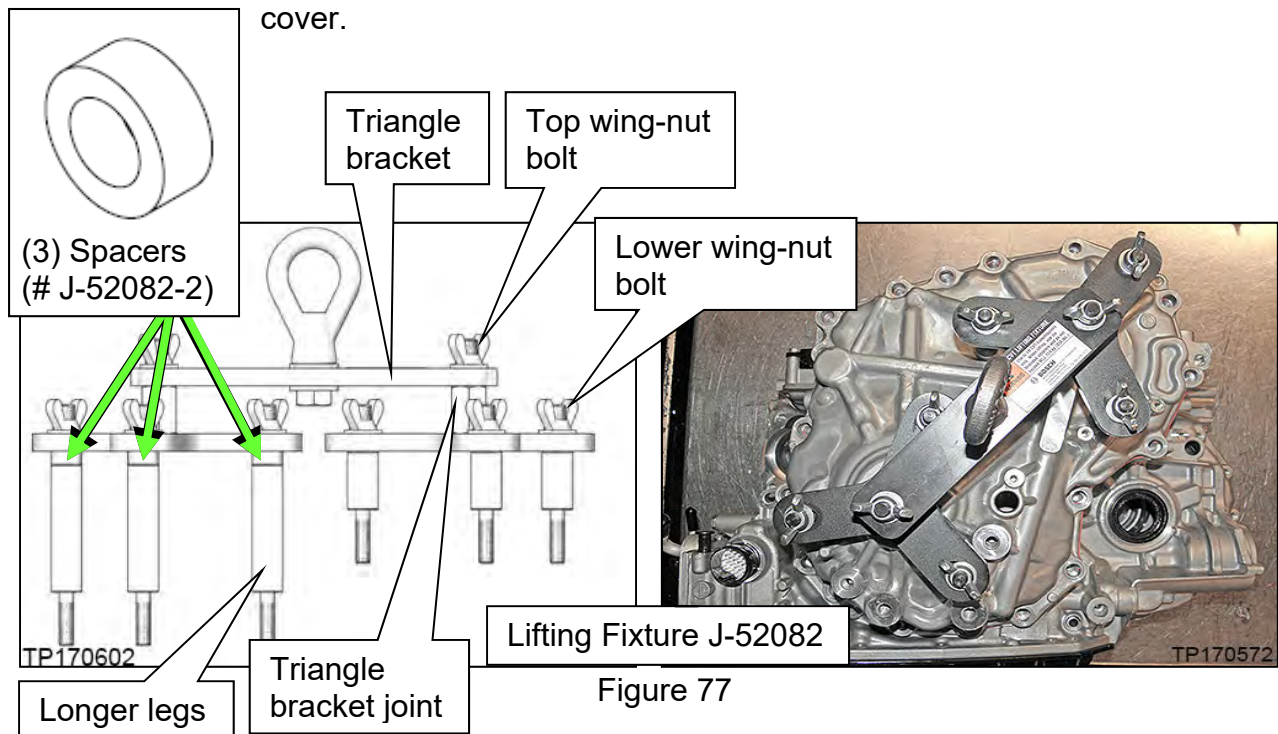

60. Install the two CVT Assembly Guide Pins (J-51959 - Guide Pins) as shown in Figure 78 and Figure 79.

- The Guide Pins must be located next to the dowel pins.

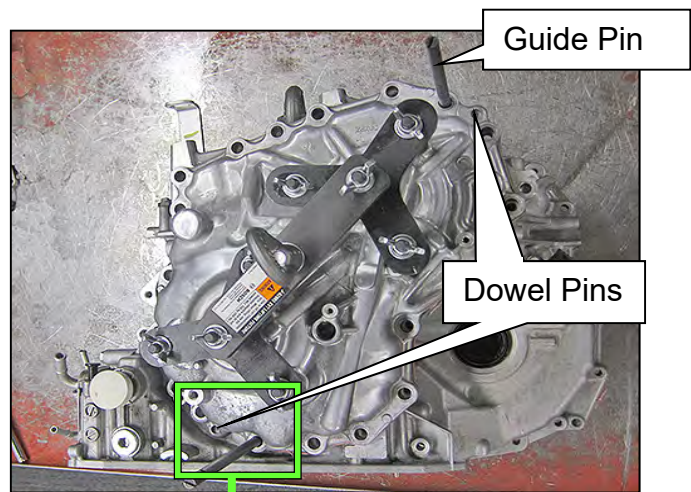

Figure 78

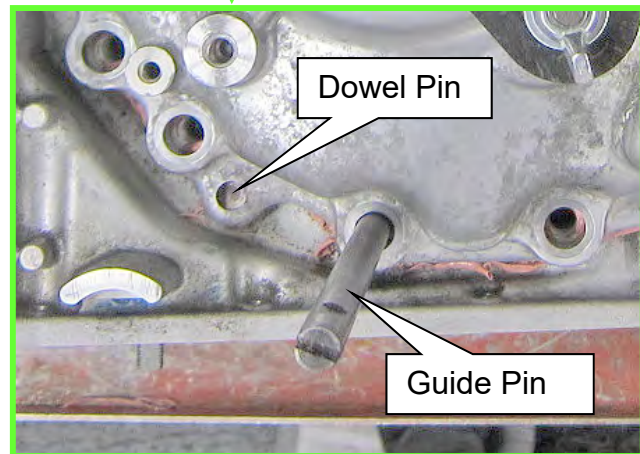
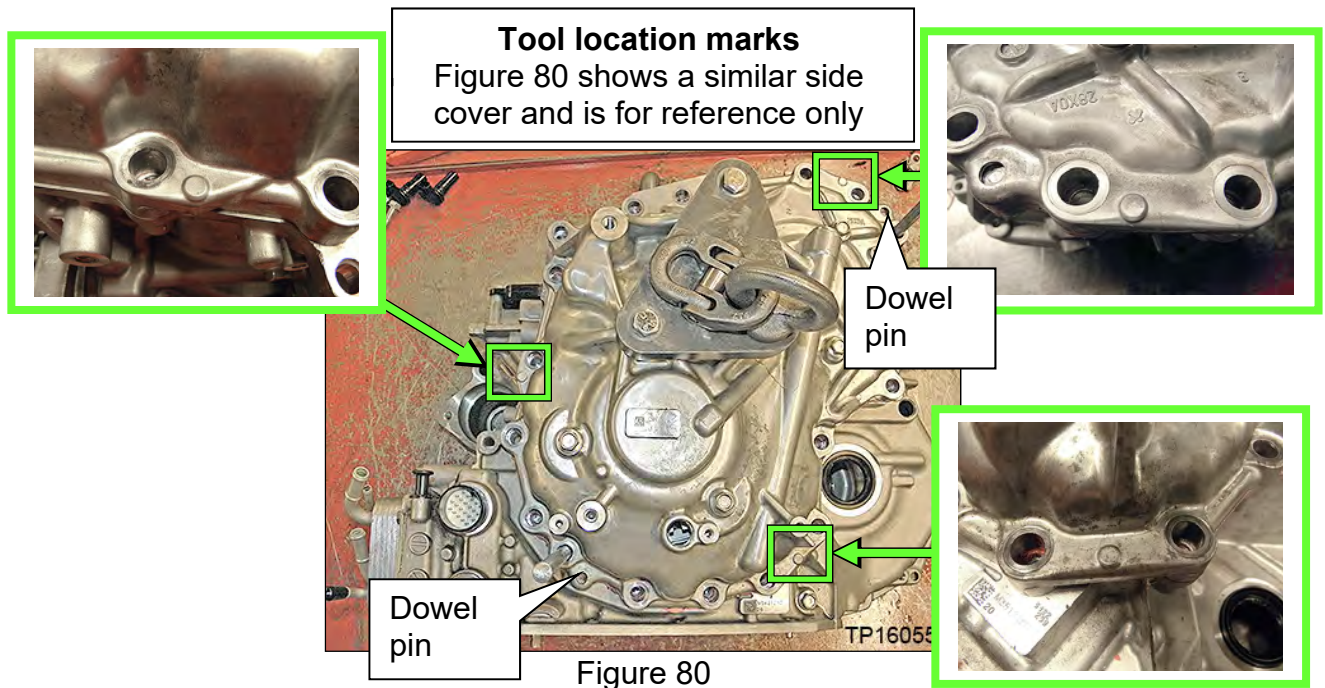

Figure 79

61. Raise the Lifting Fixture so that the CVT assembly weight is mostly supported by the Lifting Fixture and just slightly raised off of the work surface.
62. Loosen the side cover with a slide hammer at the three points (tool location marks) shown in Figure 80.
 - Rotate between the three (3) locations on the side cover until the CVT case separates from the sub-assembly; this can take more than one rotation to loosen sealant.

CAUTION: DO NOT use a pry-bar, chisel, etc. to separate the side cover from the CVT case.

NOTE: Apply rust penetrant to the two dowel pins as needed.



63. Raise the Lifting Fixture to remove the “side cover with pulleys and belt sub-assembly” (sub-assembly) from the CVT case (Figure 81).

CAUTION: Make sure the primary speed sensor is removed from the sub-assembly.

- The speed sensor will be reused.
- **DO NOT** discard the speed sensor.
- This sub-assembly will not be reused.



Figure 81

64. Remove the lifting fixture from the sub-assembly.
 - Re-install all six (6) original bolts into the old sub-assembly.
65. Thoroughly clean the mating surfaces of the CVT case (Figure 82) that the sub-assembly was just separated from (a plastic scraper can be used).
 - Confirm that the dowel pins have remained in the CVT case. If not, remove them from the sub-assembly and reattach them back to the CVT case.

NOTE: The Guide Pins can be temporarily removed for cleaning purposes.

CAUTION:

- DO NOT use sanding discs, metal blades, or similar abrasive tools.
 - Use brake cleaner or equivalent solvent and lint-free towels only.
 - Make sure brake cleaner or solvents used are compatible with local regulations.
 - Prevent debris from entering in the CVT.
 - Make sure rust and debris have been cleaned off of dowel pins and receiving holes.
66. Replace the O-ring on the CVT case side with a new one from the PARTS KITS REFERENCE TABLE; discard the original O-ring (Figure 83).
 - Coat the O-ring with CVT fluid before installing.

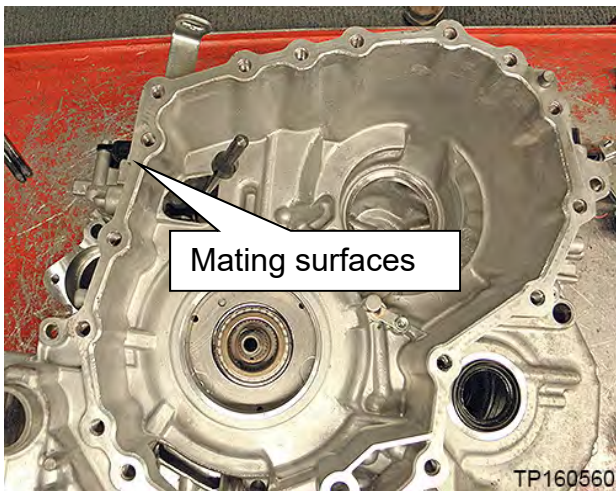

Figure 82

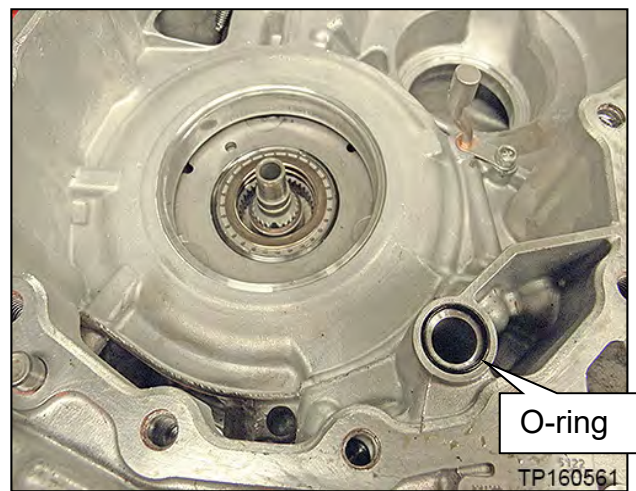

Figure 83

67. Remove the thrust bearing from the planetary carrier plate (Figure 84).
 - **This thrust bearing will be reused. DO NOT discard.**

CAUTION: If not found on the planetary carrier plate, the thrust bearing may still be attached to the primary pulley.

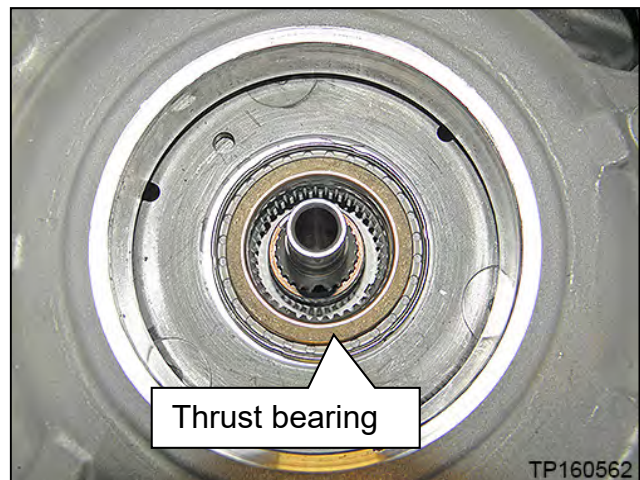

Figure 84

68. Rotate the shift select lever counter clockwise to the “L” range position (Figure 85), so that the parking pawl is at its lowest position (Figure 86).

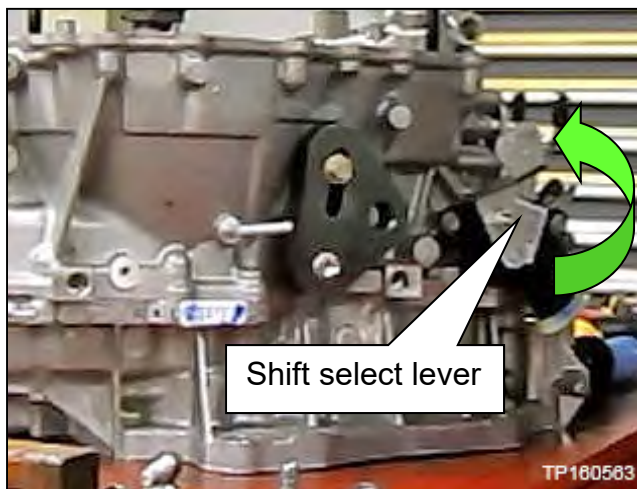

Figure 85

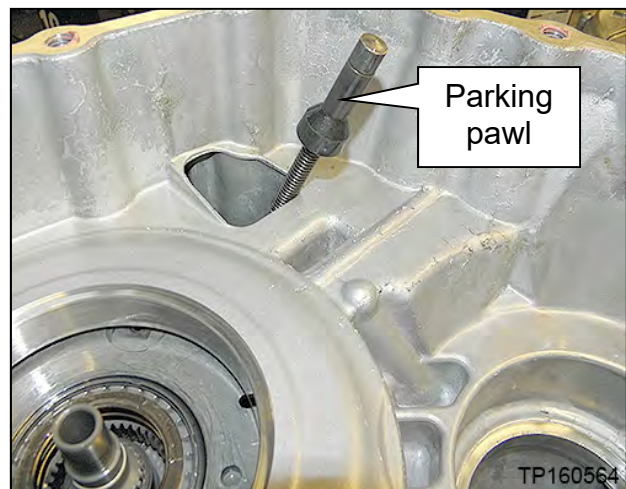

Figure 86

69. Attach the Lifting Fixture to the new sub-assembly, and then raise the sub-assembly out of the shipping box.
- First remove the six (6) bolts from the new sub-assembly and then remove their O-rings before installing the Lifting Fixture.
 - These bolts will be reused.
 - These O-rings will not be reused.

CAUTION: To prevent cross threading, always tighten the bolts by hand.

- Refer to step 58 through step 60 for lifting fixture attachment information.

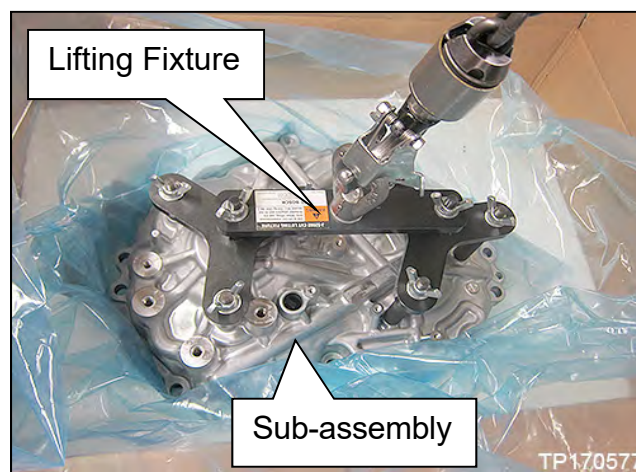

Figure 87

70. Apply one continuous 2.0 mm diameter bead of sealant along the center of the CVT case side mating surface (Figure 88).

Sealant:

- Loctite 5460 (see **PARTS INFORMATION** on page 91)
- Color: Pink

IMPORTANT:

- Confirm that the mating surfaces are clean before applying sealant.
- Make sure that the starting point and the ending point of the sealant is between two bolt holes. Overlap both ends of the bead by 3 – 5 mm.

CAUTION: Be careful not to contact or contaminate the sealant. If the sealant has been disturbed or contaminated in any way before case assembly, thoroughly clean the mating surfaces of the CVT case and re-start from step 70.

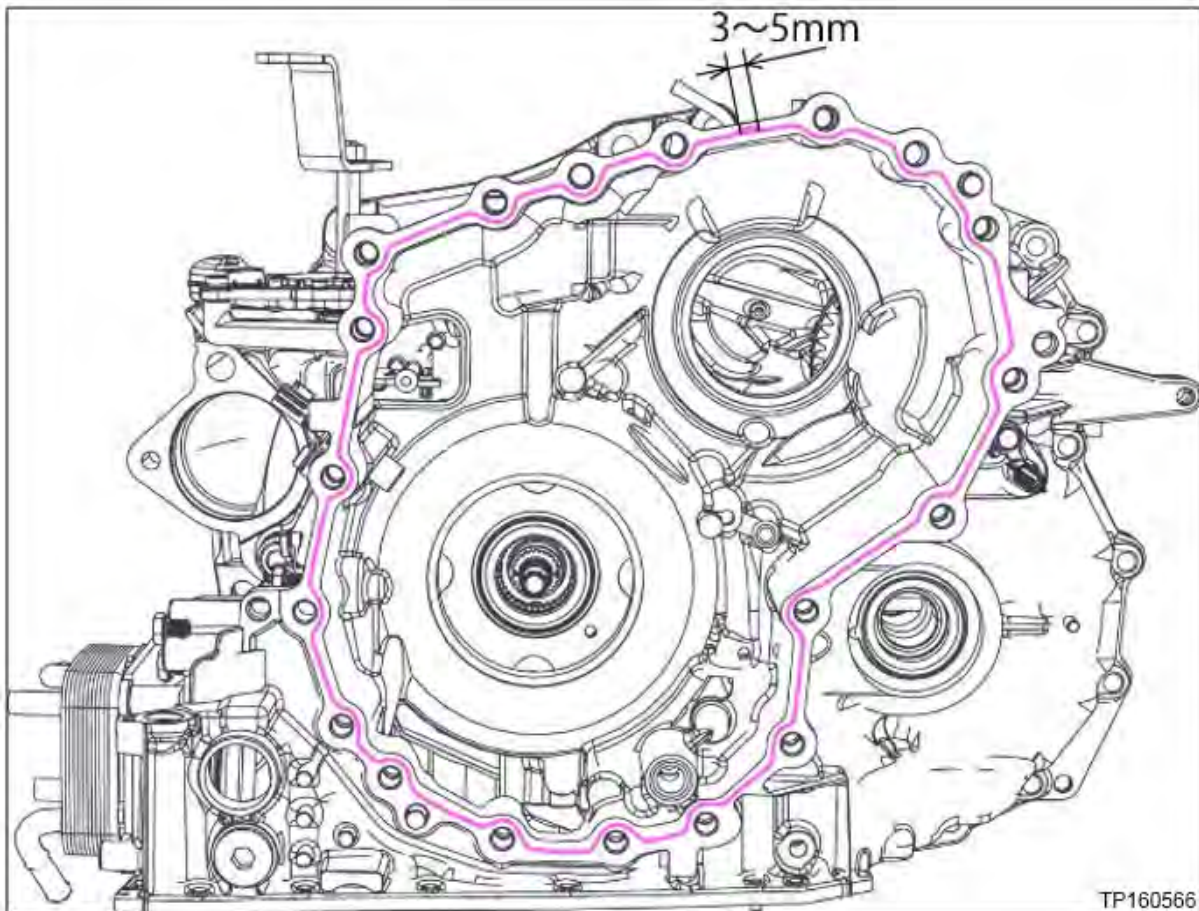

Figure 88

71. Install the original thrust bearing on the primary pulley of the new sub-assembly (Figure 89).

IMPORTANT: The thrust bearing surface must lay flush with the primary pulley. Any additional height will affect the total end play that is measured later in this procedure.

CAUTION: The thrust bearing has two sides. Reference Figure 90 for bearing orientation.

- Apply a small amount of petroleum jelly or equivalent to the original thrust bearing to hold it in place on the primary pulley.

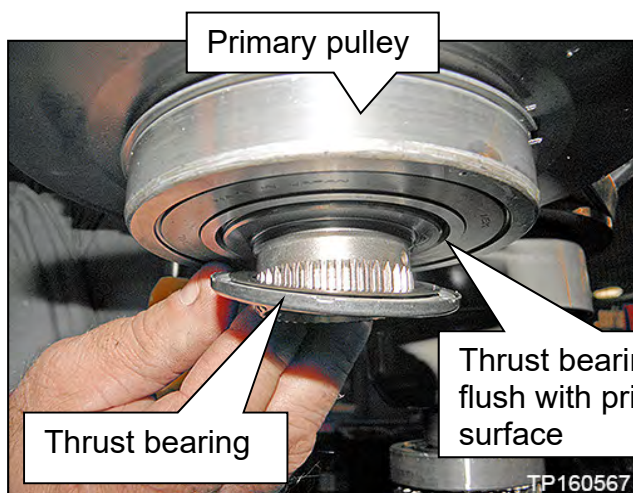

Figure 89

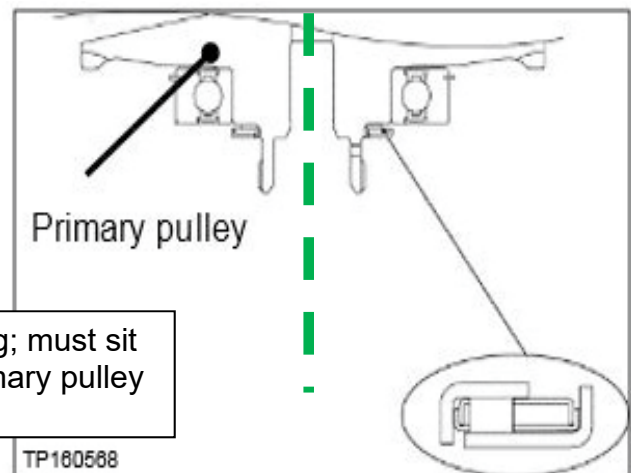

Figure 90

72. Coat the primary pulley bearing, secondary pulley gear teeth and the secondary bearing with CVT fluid prior to installation (Figure 91 and Figure 92).

CAUTION: Do NOT drip any CVT fluid onto the sealant.

The following Figures are for reference only and may or may not have the sealant in place, or have the old sealant removed. Clean the surfaces and apply sealant when and where instructed.

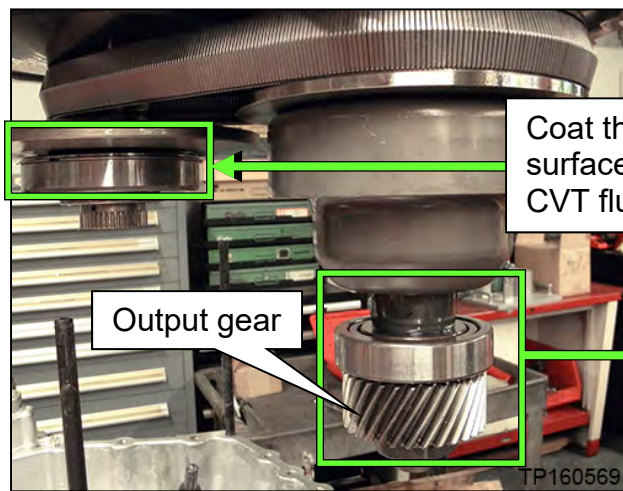

Figure 91

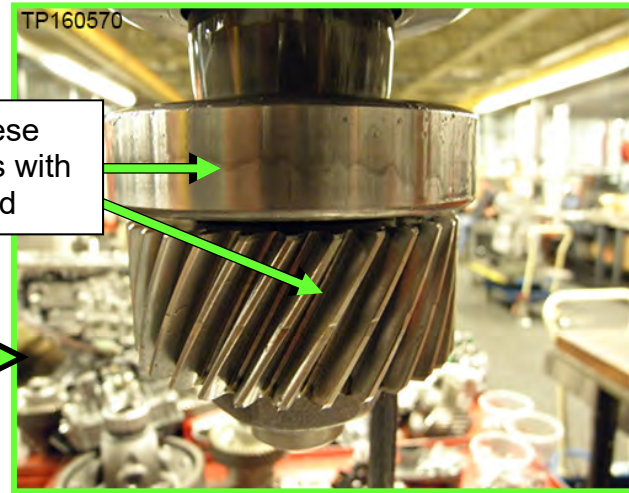

Figure 92

73. While lowering the sub-assembly, route the Guide Pins into the appropriate CVT bolt holes one at a time (the Guide Pins are different lengths for easy assembly).

IMPORTANT: Do NOT allow the output gear to contact the lubrication tube when the side cover is positioned over the guide pins (Figure 94 and Figure 95).

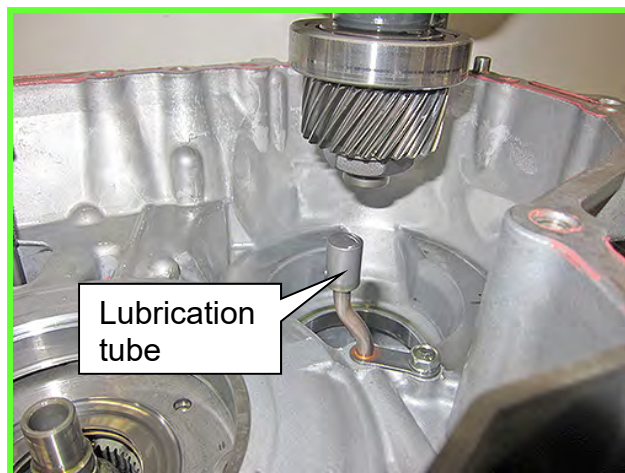

Figure 93

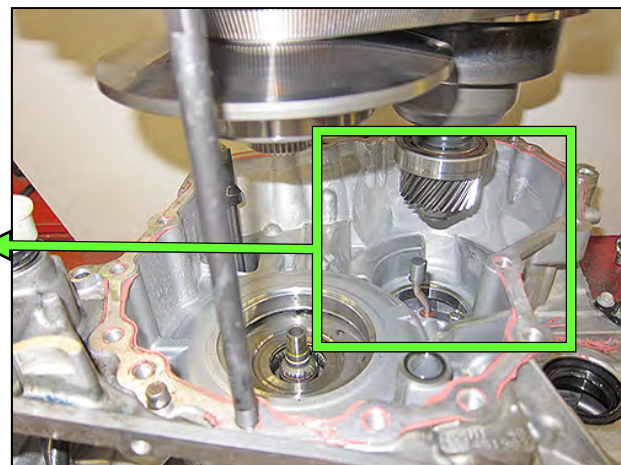



Figure 94

IMPORTANT:

Before continuing, it is recommended that you review and understand the instructions on pages 47 to 51.

The sub-assembly will lower into the CVT case without applying extra vertical force.

IF THE SUB-ASSEMBLY DOES NOT LOWER COMPLETELY,  PHYSICAL INTERFERENCE IS PRESENT.

Key Technique: Raise to remove weight on interference, adjust as necessary, and then lower again.

Use the “visual gap size” below (Figure 95 and Figure 96), between the sub-assembly and the CVT case, to determine the cause of interference.

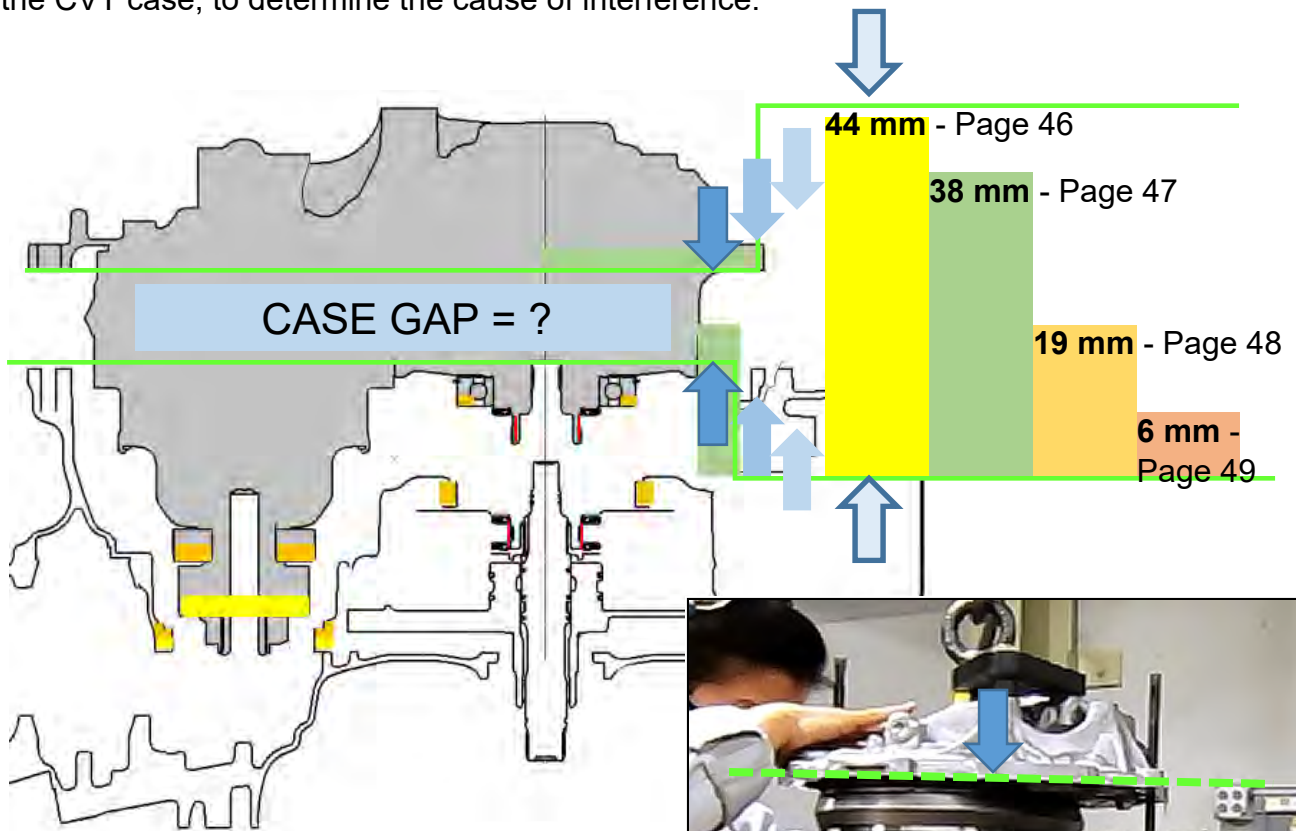

Figure 95

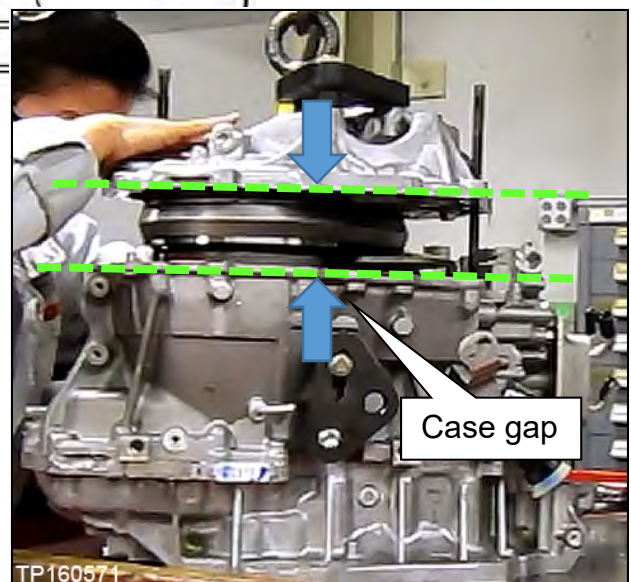

Figure 96

74. Carefully, lower the Lifting Fixture to install the sub-assembly into the CVT case until a **38 mm (1.5 inch)** gap is present between the sub-assembly and CVT case. See Figure 101 on page 49.

- Look in to the bearing bore to confirm the output gear is centered (Figure 98).
- Place hands on top of the sub-assembly to keep it level and guide it into the CVT case.
 - If the sub-assembly will not lower farther than 44 mm (1.75 inches) the output gear did not clear the bearing bore (Figure 97).

Sub-assembly will not lower past 44 mm (1.75 inches)?

- Interference is present between the output gear and bearing bore.

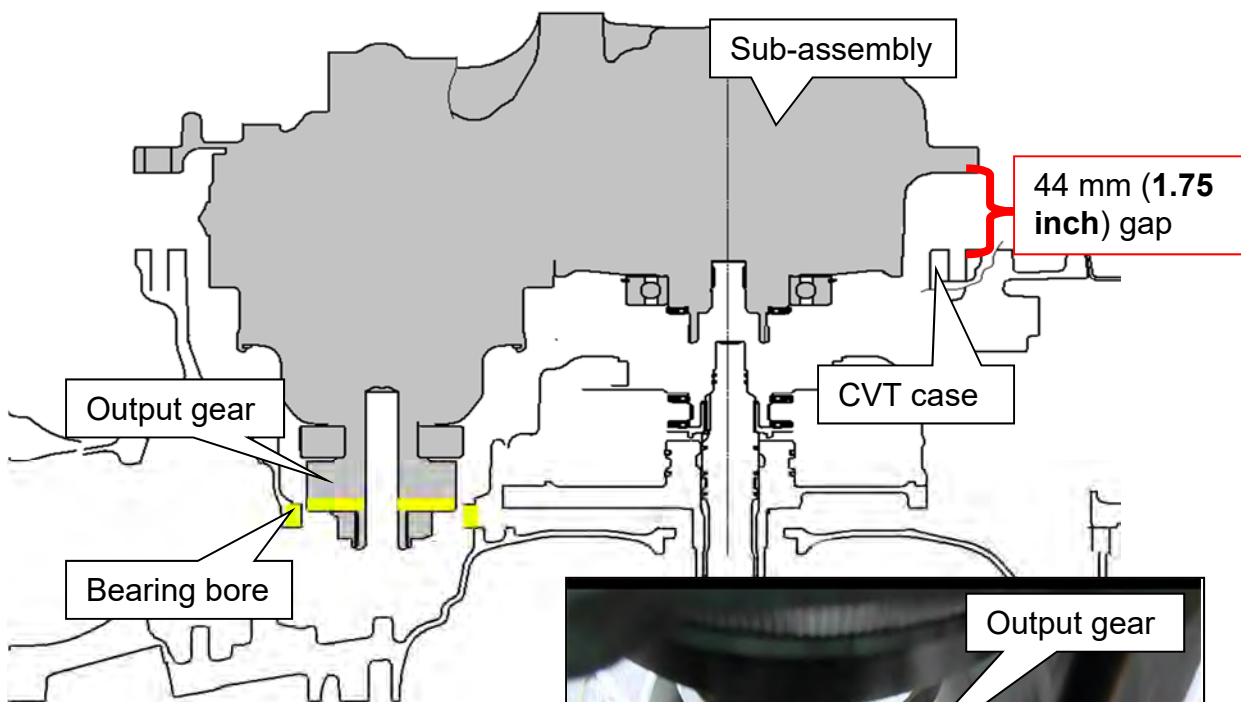

Figure 97

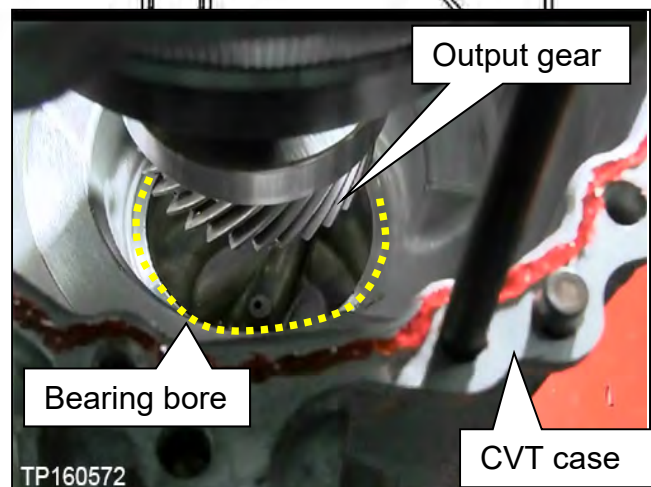



Figure 98

CAUTION: In the following steps be careful not to contact or contaminate the sealant. If the sealant has been disturbed or contaminated in any way before case assembly, remove the sealant completely and re-start from step 70 on page 44.

75. Align the parking rod with the parking pawl as follows:

IMPORTANT: Perform step 75 while there is a **38 mm (1.5 inch)** gap between the the sub-assembly and CVT case (Figure 101).

- a. Rotate the shift select lever clockwise on the side of the CVT to adjust the parking rod to the highest position.
- b. Use a magnet, or similar tool, to align the parking rod in the CVT case ( in Figure 100) with the opening in the parking pawl ( in Figure 99) in the side cover.

NOTE: If the parking rod is not located correctly it will keep the case from lowering.

The following Figures are for reference only.

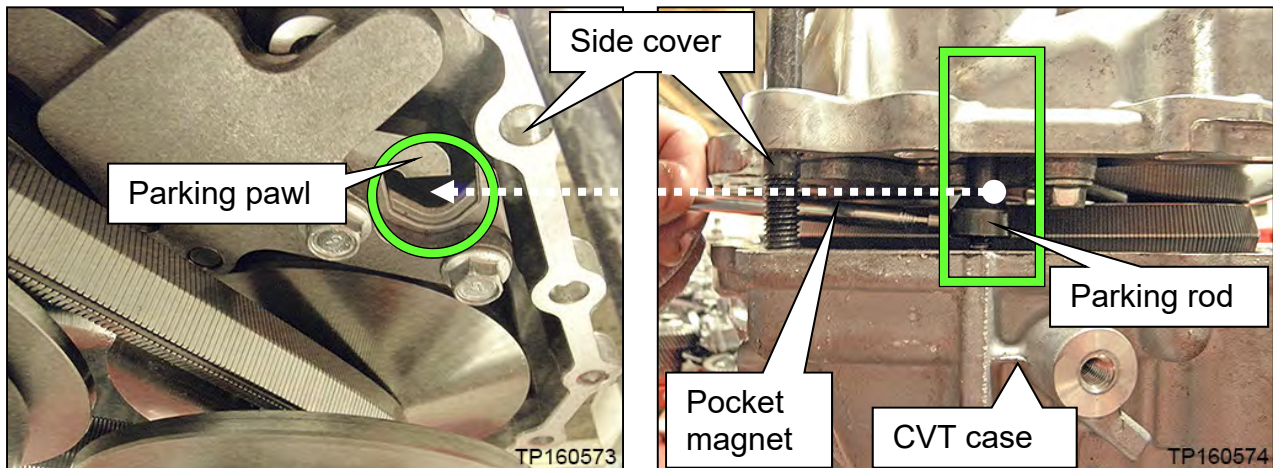

Figure 99

Figure 100

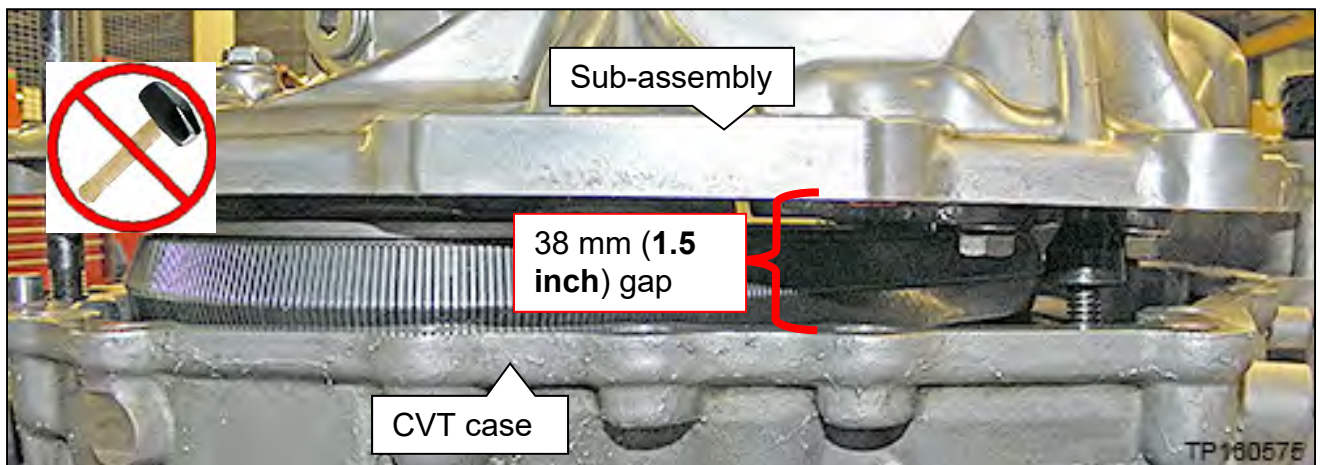

Figure 101

76. Continue to slowly lower the sub-assembly into the CVT case.

- If the primary and the secondary pulley bearings do not align properly with their bores (Figure 102) or are at an angle, a **gap of 19 mm (0.75 inches)** may be present.
 - As needed, level the sub-assembly as it is lowered into the CVT case to help the primary and the secondary pulley bearings align in their bores.
 - MINOR LEVELING ADJUSTMENTS with limited weight on the sub-assembly will help the installation. **Vertical force is not needed.**
 - Once the sub-assembly is LEVEL, the primary and the secondary pulley bearings will smoothly align while lowering.

Sub-assembly will not lower past 19 mm (0.75 inches)?

- If this occurs Do NOT force the sub-assembly into the case.
 - a. Raise the sub-assembly slightly.
 - b. Level the sub-assembly (visually check the gap between case and sub-assembly side cover and confirm that it is even all around).
 - c. Gently lower the sub-assembly.
 - d. Gently shake the sub-assembly horizontally, lower, raise and repeat as needed to help align.
 - e. Lower to engage the dowel pins and a **6 mm (0.25 inch)** gap is between the sub-assembly and CVT case.

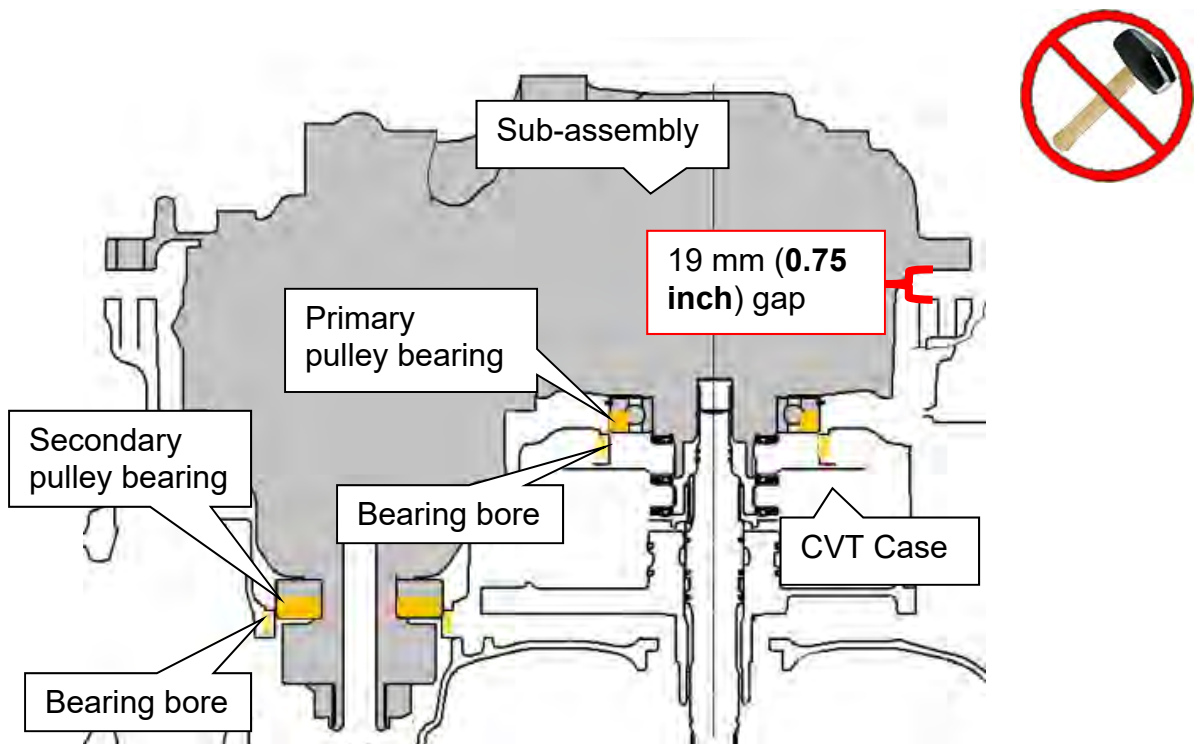

Figure 102

IMPORTANT: In the following steps the case halves must sit flush against each other without a gap before installing the bolts. The bolts CANNOT be used to draw the cases together. DO NOT APPLY VERTICAL FORCE.

77. Once the dowel pins are cleared, ease the sub-assembly down onto the CVT case until the case halves are flush.
- Confirm the dowel pins are clean and aligned and are not catching on the sub-assembly case cover.

WARNING: Be careful not to get fingers caught between the CVT case and sub-assembly when seating.

Sub-assembly will not lower past 6 mm (0.25 inches)?

If the sub-assembly will not lower past **6 mm (0.25 inches)**, the primary pulley splines are not aligned.

- If this occurs Do NOT force sub-assembly into case.
 - a. Raise the sub-assembly slightly so the weight is not completely on the primary pulley splines.
 - b. Slightly rotate the primary pulley through the bottom of the CVT and then lower the sub-assembly.
 - c. Repeat as needed.

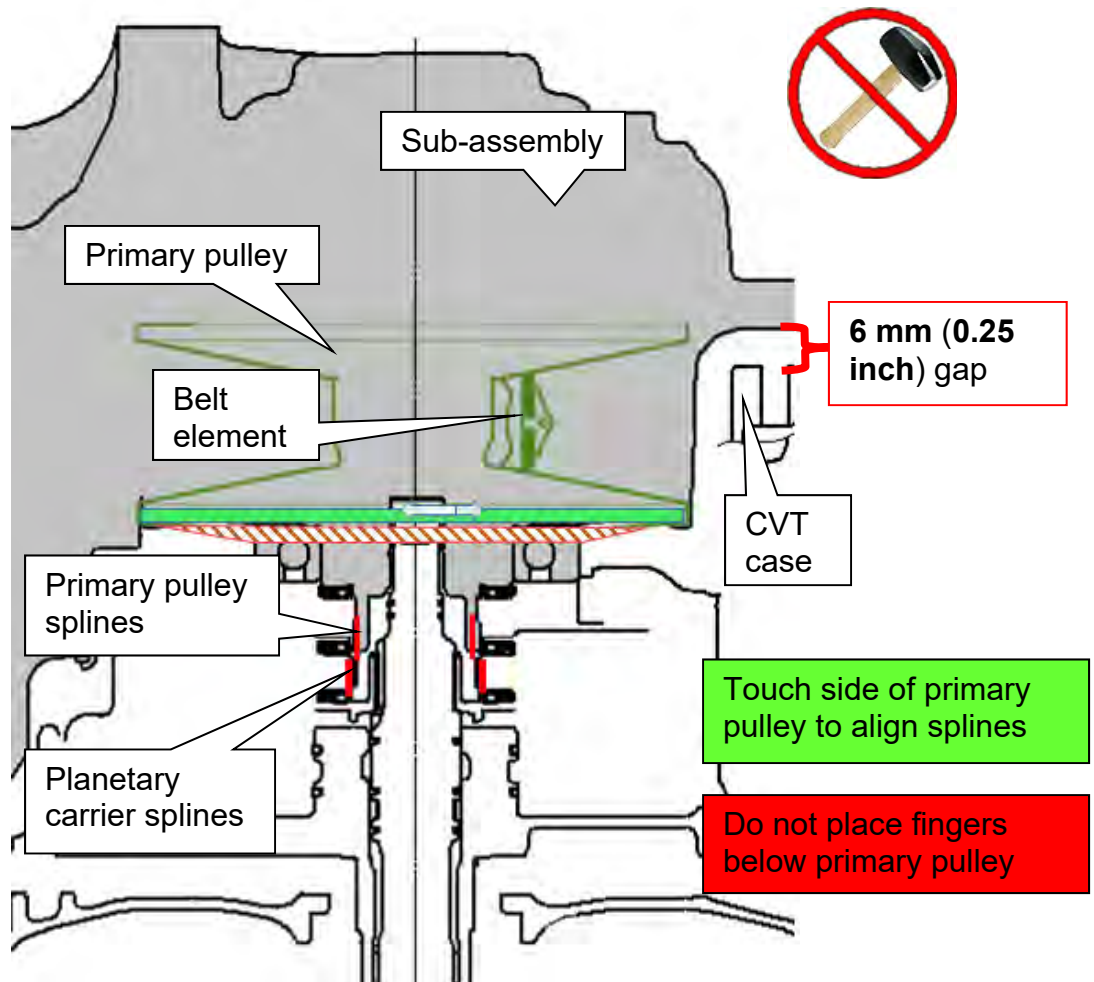

Figure 103

Rotate the shift select lever

78. Confirm the parking rod operation as follows:

- a. Rotate the shift select lever counter clockwise and confirm that all detents for each of the P-R-N-D-L are felt.
- b. Rotate the lever clockwise to return the rod back to the **P** position.
- c. Are all of the detents felt?

➤ **YES:** Proceed to step 79.

➤ **NO:** If the lever does not rotate or if all detents are not felt:

- 1) Raise the sub-assembly and remove all sealant.
- 2) Restart from step 70 on page 44.

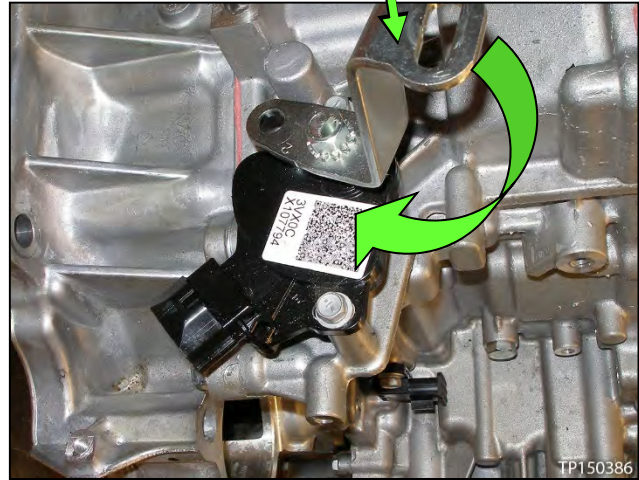

Figure 104

79. Remove the guide pins.

80. Install the new side cover bolts (Figure 105).

- Torque the first eight (8) bolts marked as ● in the sequence numbered in Figure 105 below, and then torque the rest of the bolts in a clockwise direction.
- Bolt torque: 45 N•m (4.6 kg-m, **33 ft-lb**) 19 pieces.

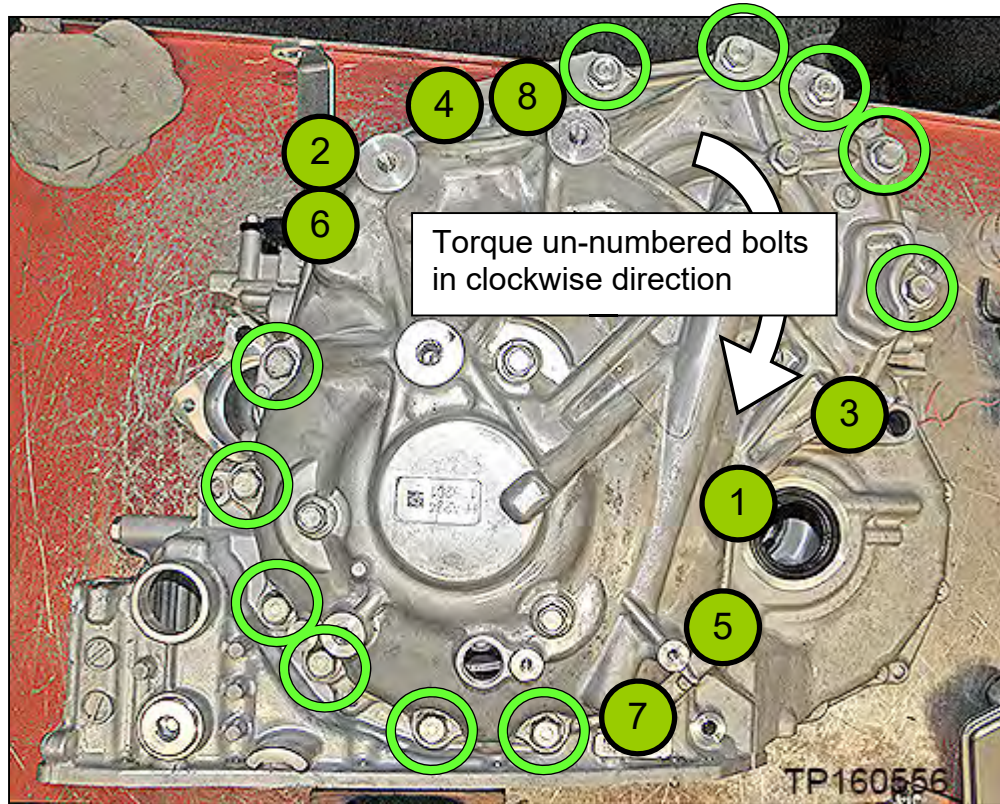

Figure 105

81. Remove the Lifting Fixture.

82. Install six (6) new O-rings, from the **Parts Kits Reference Table** on page 95, to the six (6) new pulley bearing retainer bolts that were removed from the new sub-assembly on page 43, step 69.

83. Install the six (6) new pulley bearing retainer bolts finger tight.

- Do not use tools to install.

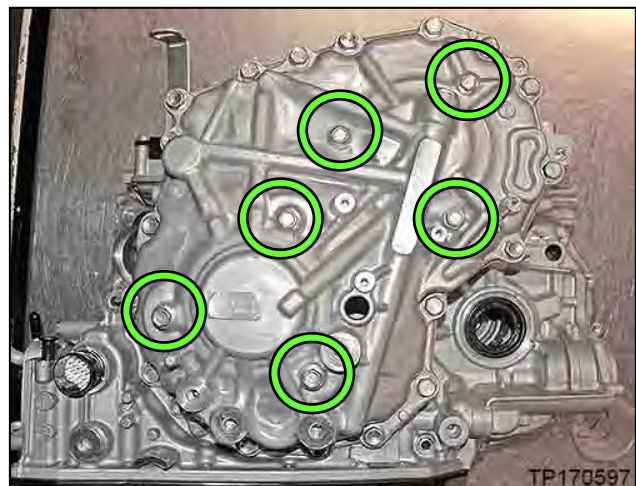

Figure 106

84. Confirm the rotational smoothness of the primary pulley as follows:
- a. With a clean hand, access the primary pulley from the bottom of the CVT.
 - b. Rotate the primary pulley by hand and confirm that the characteristic is the same as previously checked at step 56 on page 37, prior to removing the original sub-assembly.
 - If the rotational characteristic is the same or better, continue to step 85.
 - If the rotational characteristic is worse (stiffer):
 - 1) Remove the sub-assembly from the CVT case.
 - 2) Wipe and clean the sealant from the CVT case and side cover rim.
 - 3) Restart the procedure from step 70 on page 44.

85. Torque all six (6) bolts.
- Bolt torque: 28 N•m (2.8 kg-m, **20 ft-lbs**).



Figure 107

86. Install the CVT case side axle seal (Figure 108).
- Use Seal Installer J-52281 and Driver Handle J-8092.
 - Apply a light coat of CVT fluid to the seal lip surfaces.

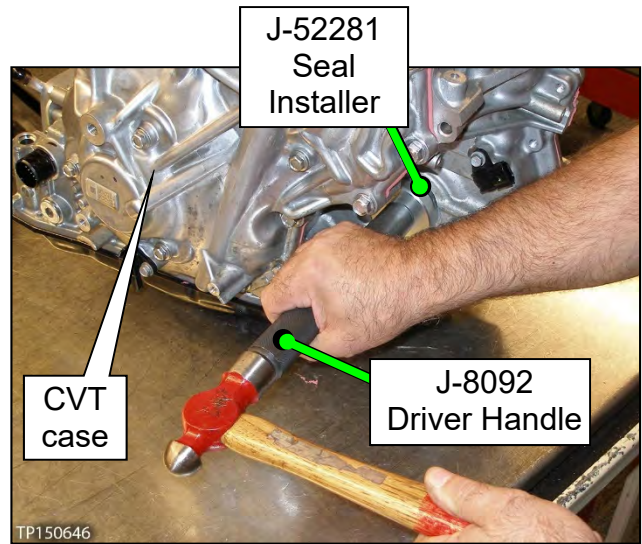

Figure 108

87. Place the CVT on the work bench with the side cover facing down on the bench.

88. Remove the converter housing, which was temporarily installed with three bolts.

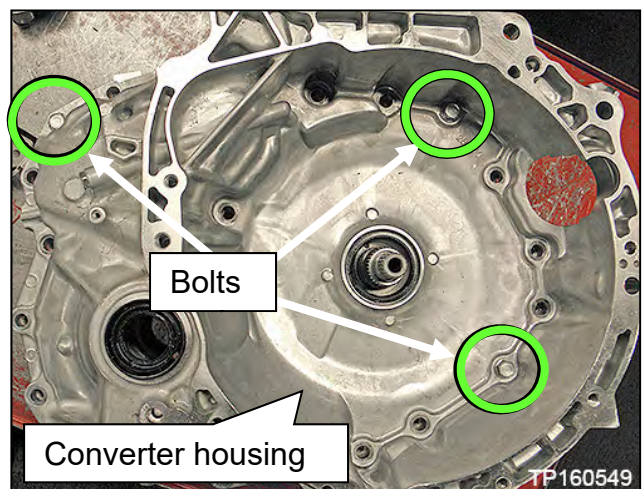

Figure 109

Clutch Total Endplay Adjustment – Thrust Bearing Selection

IMPORTANT: Using thrust bearings, the clutch total endplay (Figure 110) must always be adjusted between the clutch drum and the dummy cover when a new sub-assembly is installed.

There are eight (8) thicknesses of thrust bearings available for total endplay adjustment.

- For additional information, see video # **547: “CVT Belt and Pulley Replacement”** and fast forward to minute marker **13:22**. This video is located under the TECH TRAINING GARAGE VIDEOS tab in Virtual Academy.

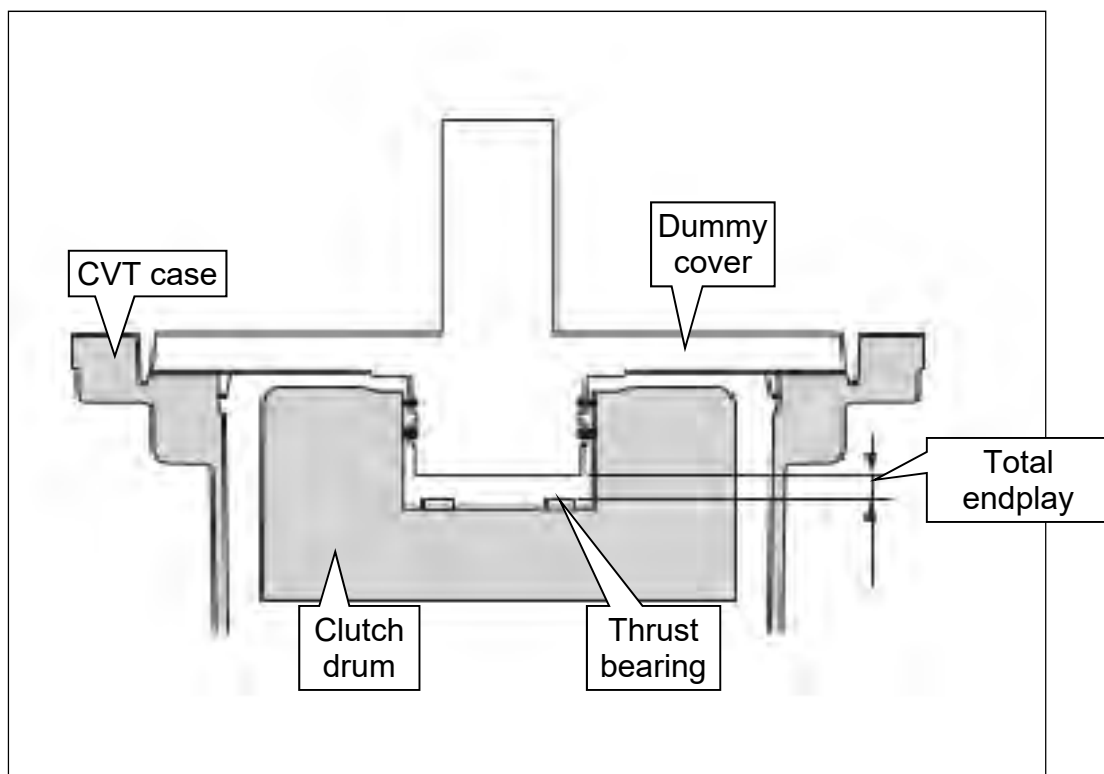

Figure 110

89. Clean and then zero the Digital Depth Gauge (part #: J-50272).
 - Set the Digital Depth Gauge to millimeters.
90. Clean Gauge Block J-50271.
91. Confirm the mating surfaces of the CVT case are clean.

92. Calculate the average (D) clutch assembly bore depth (Figure 111) as follows:

IMPORTANT: Measurements are required from two opposite ends to obtain the average.

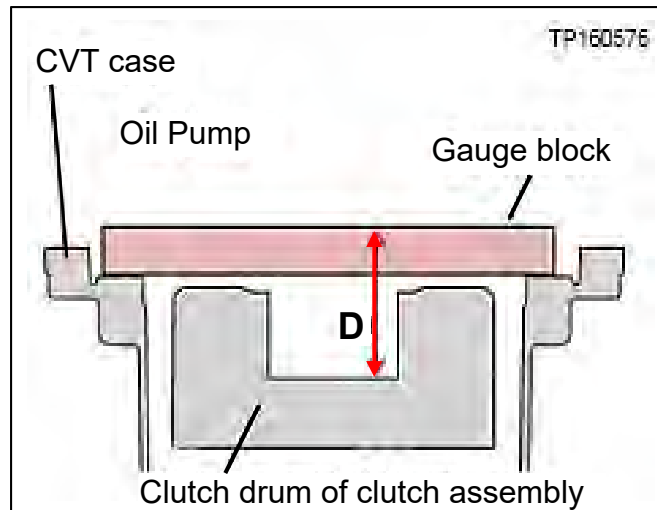

Figure 111

- a. Place the Gauge Block on the surface where the dummy cover seats and over the clutch assembly bore (Figure 112).

IMPORTANT: This surface is lower than the CVT case to torque converter housing surface.

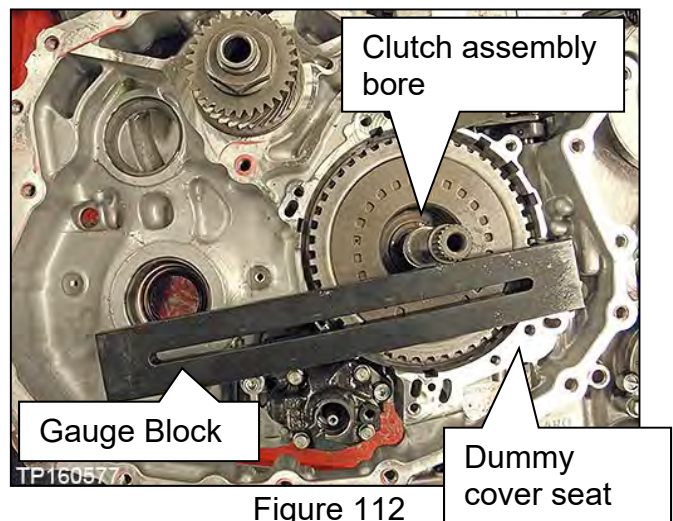

Figure 112

NOTE: The clutch assembly should sit 2-3 mm lower than the dummy cover seat (Figure 113).

- b. Confirm the Gauge Block is not sitting on the clutch assembly or against the input shaft.

NOTE: If the clutch assembly is sitting higher than the dummy cover surface, see **Dummy Cover Troubleshooting** on page 33.

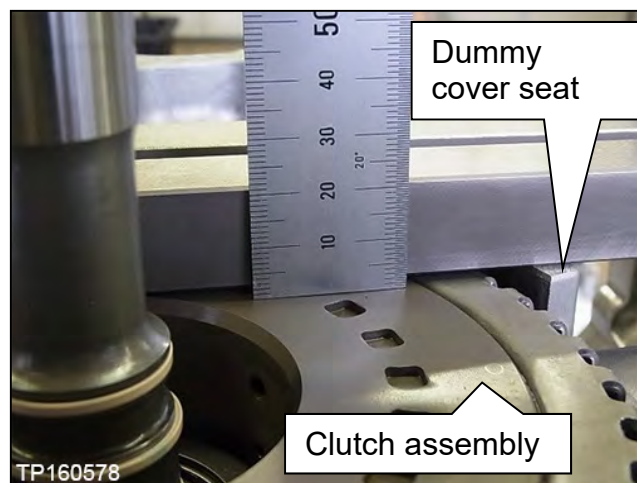

Figure 113

- c. Position the Depth Gauge on the Gauge Block (Figure 114).

NOTE: Make sure the Depth Gauge's datum level is flush with the top of the Gauge Block.

- d. Carefully slide the gauge down until it bottoms out on the bottom of the clutch assembly bore. Write this measurement as **D1** (use millimeters).

NOTE: Do not measure from the clutch assembly bore shown in red (Figure 115).

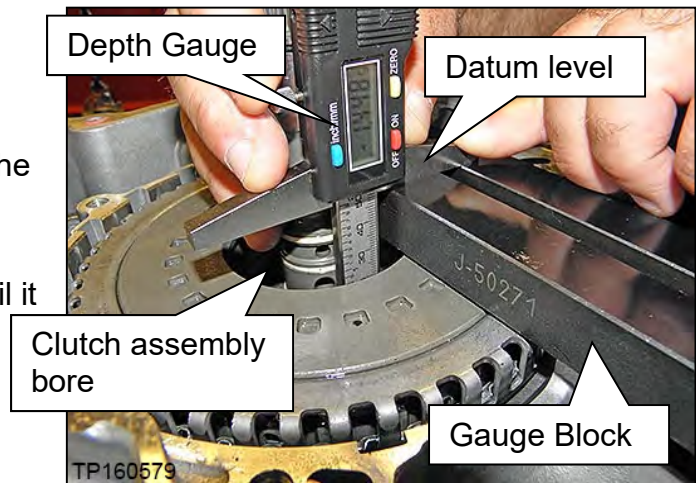

Figure 114

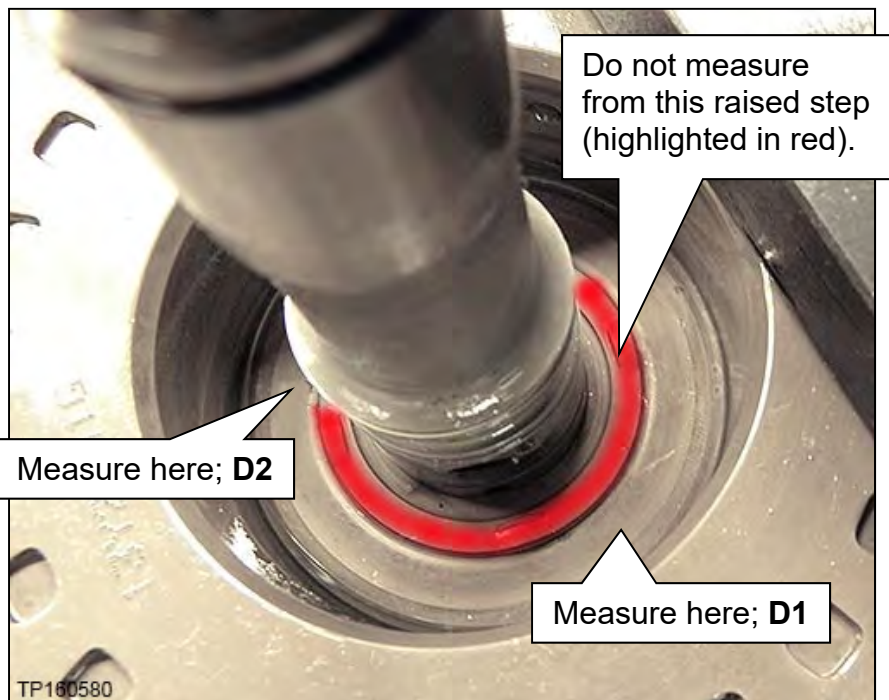

Figure 115

- e. Measure this same distance on the opposite side (180 degrees) of the clutch assembly bore and write it as **D2**.
- f. Using the formula below, calculate the average and write down the calculated value as **D**.

$$D = \frac{(D1 + D2)}{2}$$

Write the measurement for "D" here _____ mm

93. Measure the average (**H**) dummy cover height (Figure 117) as follows:

- a. Clean the dummy cover surfaces that contact the CVT case and thrust bearing (Figure 116).

CAUTION: Use brake cleaner (or equivalent) and a lint-free towel only. Make sure the brake cleaner or solvents used are compatible with local regulations.

- b. Place the dummy cover upside down on a work bench, and place the Gauge Block onto the thrust bearing surface (Figure 117).

- c. Position the Depth Gauge on the Gauge Block over an outer end of the dummy cover (Figure 117).

NOTE: Make sure the Depth Gauge's datum level is flush with the top of the Gauge Block.

- d. Carefully slide the Depth Gauge down until it contacts the dummy cover surface that mates with the CVT case. Write this measurement as **H1** (use millimeters).
- e. Measure this same distance on the opposite side of the dummy cover and write it as **H2** (Figure 117).

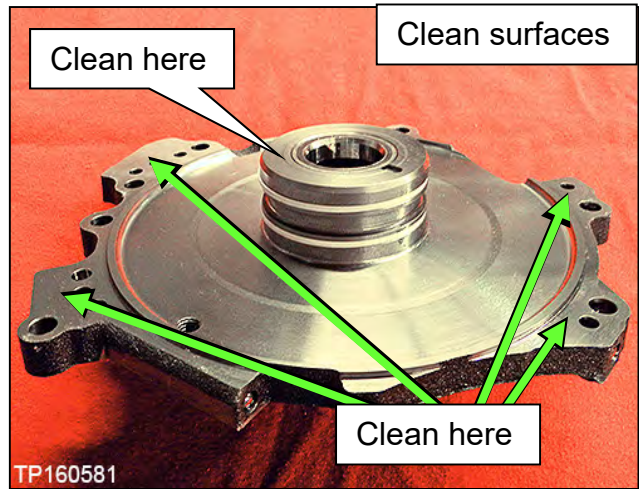

Figure 116

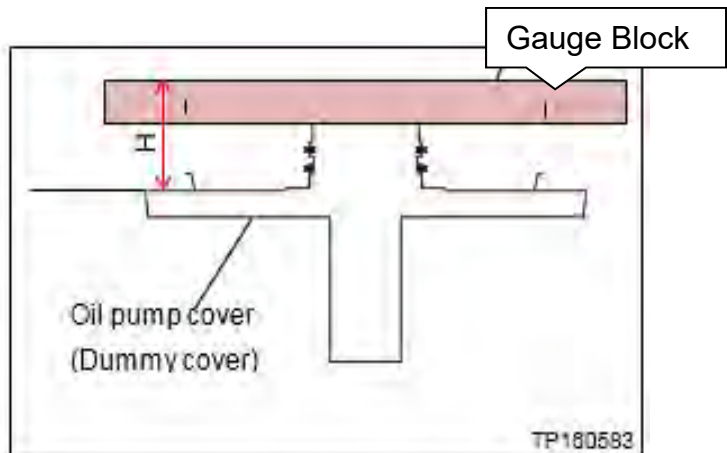
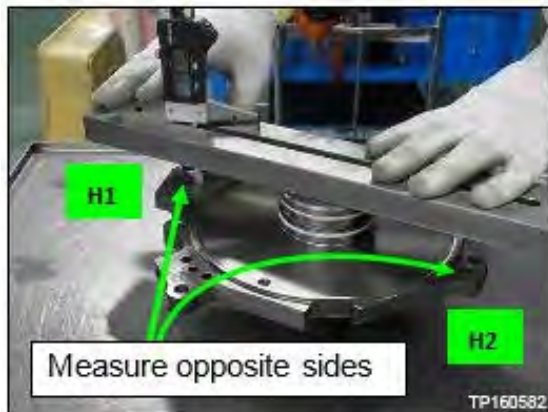

Figure 117

- f. Using the formula below, calculate the average and then write down the calculated value as **H**.

$$H = \frac{(H1 + H2)}{2}$$

Write the measurement for "H" here _____ mm

94. Choose the thrust bearing to adjust Clutch Total Endplay (**A**) as follows:

- a. Calculate **A** (Total Endplay):

Total Endplay A = D – H (This will be the thrust bearing thickness).

- Fill in the measurements below for "D" and "H" from pages 58 and 59 to calculate for "A".

D measurement _____ mm
 – H measurement _____ mm
 = **A** _____ mm

Please print this page and attach it to the repair order.

- b. Choose the appropriate bearing from **Table A** below, based on the Total Endplay (A) calculated on the previous page (8 thicknesses of thrust bearings are available).
Example: If **A** = 4.3 mm, it falls between the lower and upper clearances for bearing thickness 3.93 mm.
- Refer to the **PARTS INFORMATION** on page 91 for Thrust Bearing part numbers by thickness.
- c. Measure and confirm that the selected thrust bearing is the correct thickness before installing (Figure 118).
- d. Circle the thrust bearing part number that was selected in **Table A**.

Table A

| PART #: 31407- | A = D - H CLEARANCE (A) | BEARING THICKNESS |
|-----------------------|------------------------------------|------------------------------|
| 1XZOB | 3.87 - 4.07 MM | 3.57 |
| 1XZ0C | 4.08 - 4.23 mm | 3.75 |
| 1XZ0D | 4.24 - 4.43 mm | 3.93 |
| 1XZ0E | 4.44 - 4.58 mm | 4.1 |
| 1XZ1A | 4.59 - 4.78 mm | 4.28 |
| 1XZ1B | 4.79 - 4.94 mm | 4.46 |
| 1XZ1C | 4.95 - 5.09 mm | 4.61 |
| 1XZ1D | 5.10 - 5.29 mm | 4.79 |



Figure 118

95. Install the thrust bearing flush to the clutch assembly bore as shown in the Figures below.

- Install the thrust bearing in the area shown in green so that it is centered by the four tabs.

CAUTION: The thrust bearing has two sides. See Figure 119 through Figure 122 for the correct orientation.

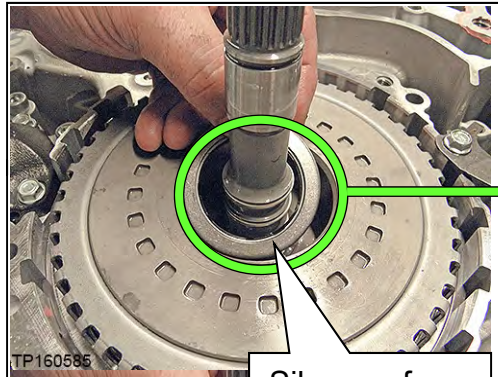

Figure 119

Silver surface faces **UP**



Figure 120

Four Alignment tabs. (One not shown).

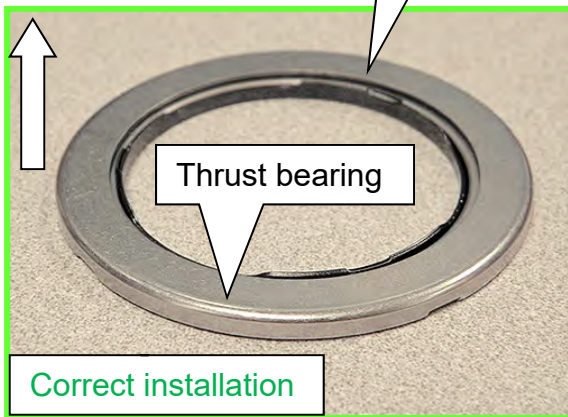

Figure 121

Correct installation

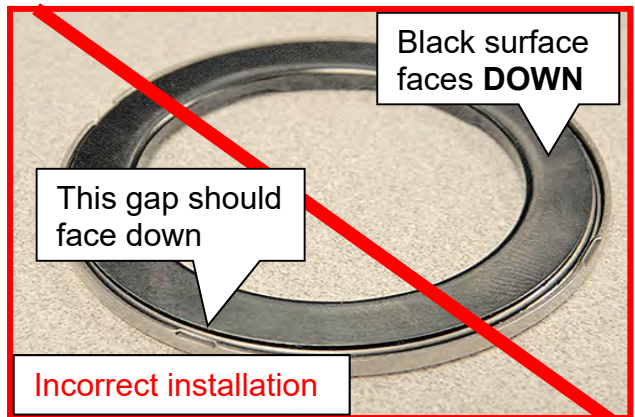

Figure 122

Incorrect installation

Black surface faces **DOWN**

This gap should face down

Clean the Converter Housing Passages

IMPORTANT: Remove as much of the CVT and cleaning fluids as possible, and clean the related parts in the following steps.

96. Remove the baffle plate and lubrication tube as follows:

a. Remove the three bolts, and then remove the baffle plate from the converter housing (Figure 123).

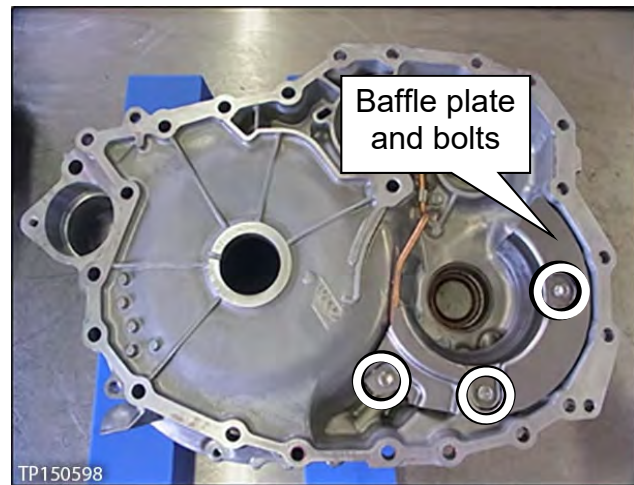

Figure 123

b. Remove the bolt and then remove the lubrication tube and its bracket (Figure 124).

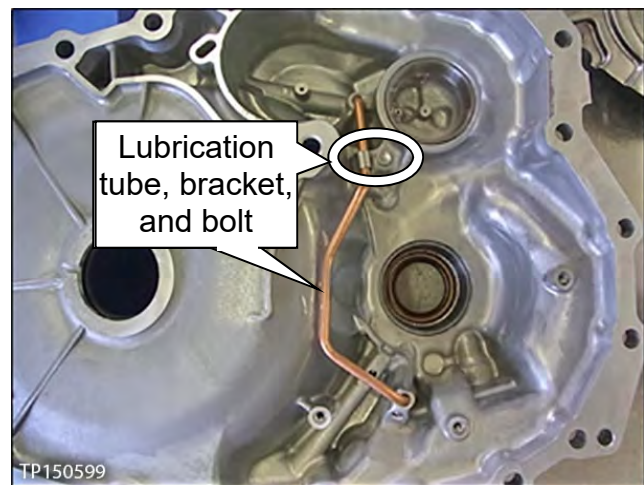

Figure 124

97. Clean the oil passages of the converter housing, lubrication tube and dummy cover with brake cleaner (or equivalent) where shown in Figure 125 through Figure 128 below.

NOTE: Do not stand in front of the passages shown while using compressed air.

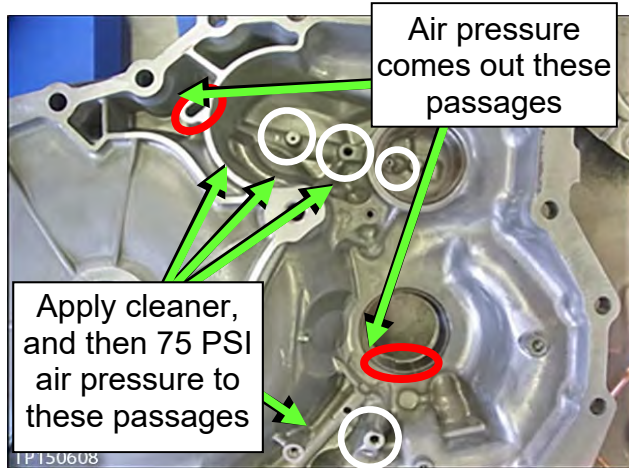

Figure 125



Figure 126

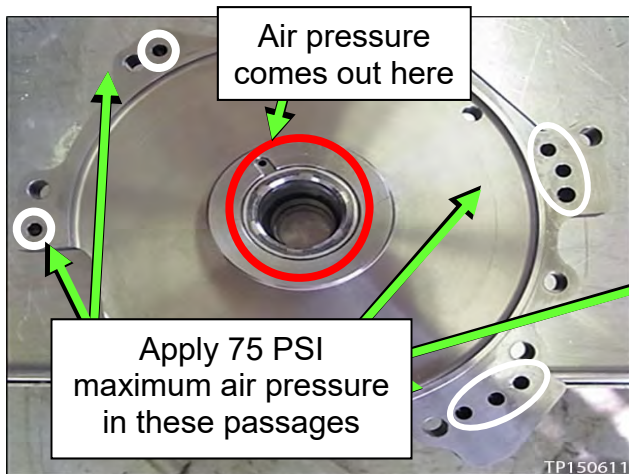

Figure 127

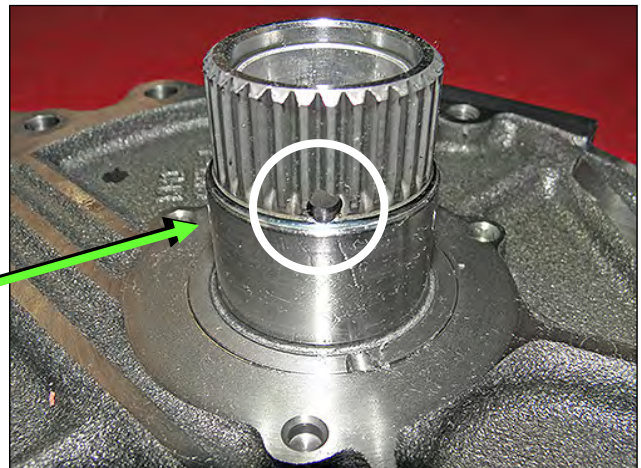

Figure 128

98. Install the lubrication tube, bracket and bolt, and then the baffle plate with three bolts (Figure 129 and Figure 130).

- Bolt torque: 5.9 N•m (0.6kg-m, **52 in-lb.**)

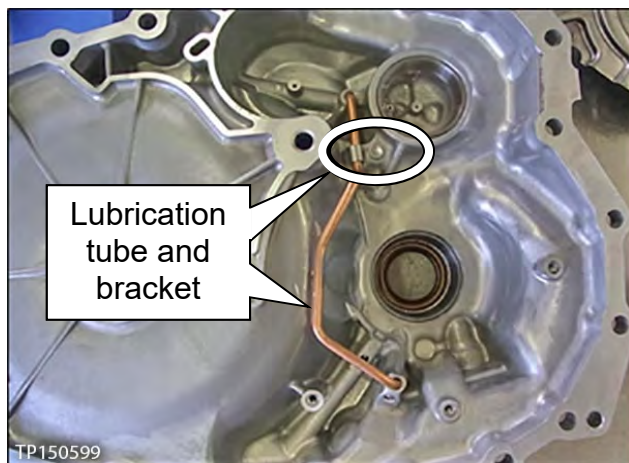

Figure 129

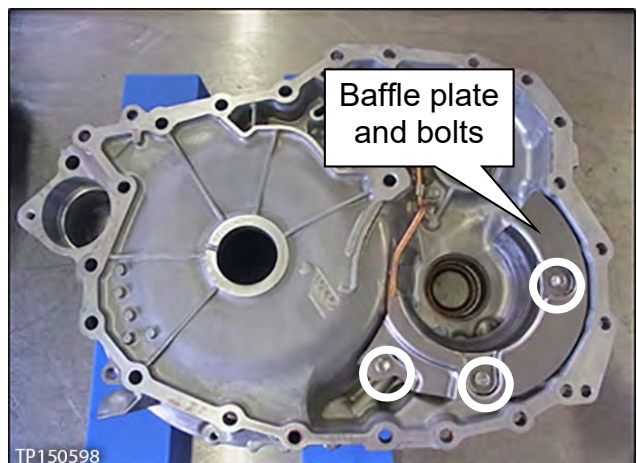

Figure 130

CVT Reassembly

99. Install a new torque converter seal with Seal Installer J-50818 (Figure 131).

- Place the torque converter housing flat during installation.
- Apply a light coat of CVT fluid to the seal lip surfaces.
- The torque converter housing seal will be 0.5 mm (**0.020 inches**) below the bore's surface when the seal installer bottoms out.



Figure 131

100. Install the torque converter housing side axle seal (Figure 132).

- Use Seal Installer J-52282 and Driver Handle J-8092.
- Apply a light coat of CVT fluid to the seal lip surfaces.



Figure 132

101. Apply petroleum jelly or equivalent to the dummy cover's lathe cut seals (Figure 133) before installing the dummy cover to the CVT case.

IMPORTANT:

- Confirm that the lathe cut seals (white seals) are in their appropriate slots. Carefully reposition the seals as necessary.
- **Lathe cut seals must be in their correct positions during final assembly to prevent drivability issues.**

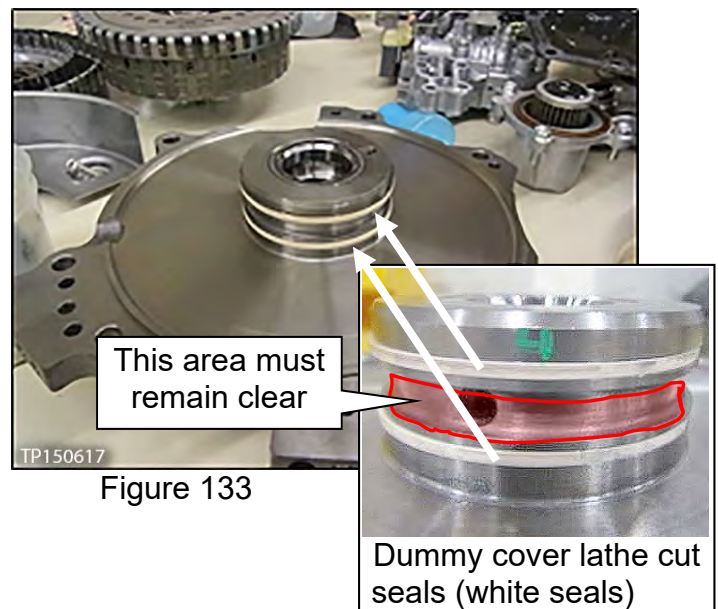

Figure 133

102. Confirm that the input shaft's lathe cut seals are in the correct positions (Figure 134).

IMPORTANT:

- Lathe cut seals (white seals) must be in their appropriate slots. Carefully reposition seals as necessary.
- **Lathe cut seals must be in their correct positions during final assembly to prevent drivability issues.**

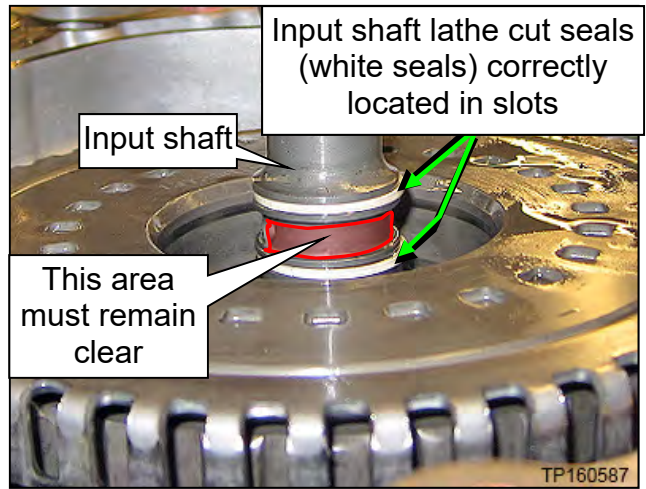

Figure 134

103. Install the dummy cover first, then baffle plate C, and then the related bolts finger tight (Figure 135).

IMPORTANT: Visually check that the dummy cover is fully seated on the CVT case. If it is not, refer to **Dummy Cover Troubleshooting** on page 33.

- Do not force the dummy cover into place.
- Make sure the dummy cover is fully seated before installing the bolts.
- Do not torque these bolts at this time.

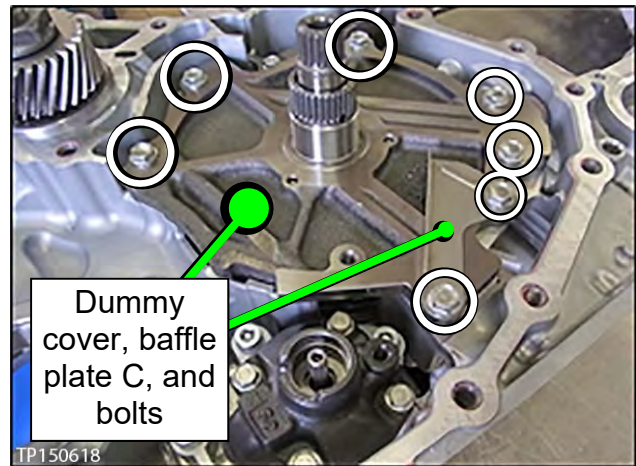

Figure 135

104. Install baffle plate B and "L" bracket with the related bolts finger tight (Figure 136).

105. Torque the bolts from steps 103 and 104 in the following order:

- a. Baffle plate B bolts: 5.9 N•m (0.6 kg-m, **52.2 in-lb.**)
- b. "L" bracket bolts: 25.5 N•m (2.6 kg-m, 19 ft-lb). Torque **1** and then **2**.
- c. Dummy cover and baffle plate C bolts torque: 19.0 N•m (1.9 kg-m, **14 ft-lb.**)

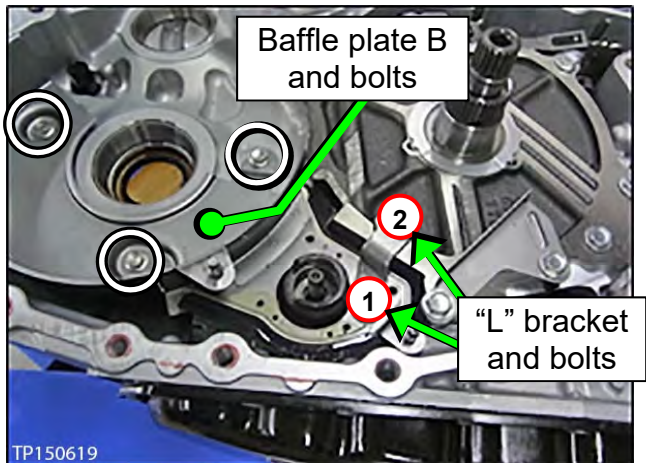

Figure 136

106. Install the thrust washer onto the dummy over (Figure 137).
- Use petroleum jelly or equivalent to hold the thrust washer in place.
 - Make sure the tabs fit into the holes.

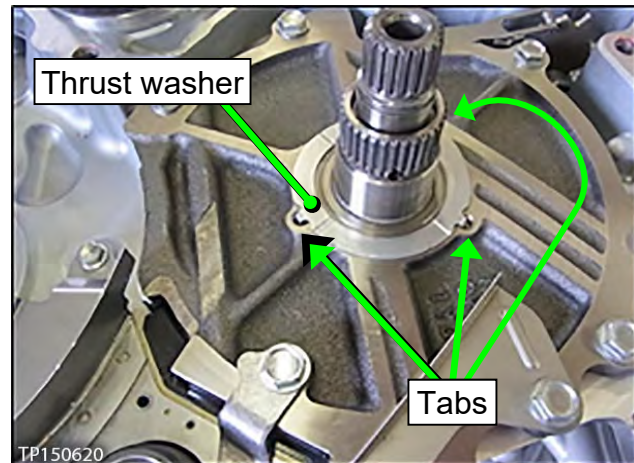

Figure 137

107. Install the drive sprocket, driven sprocket, and chain as an assembly (Figure 138).

- Make sure the raised edge (wider edge) on the drive sprocket is facing up (Figure 139).

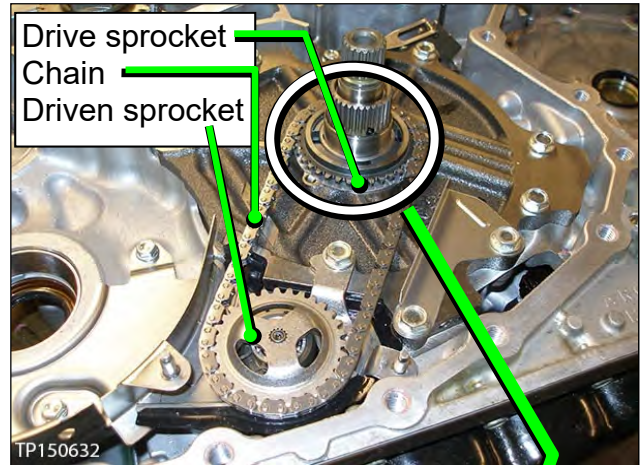

Figure 138

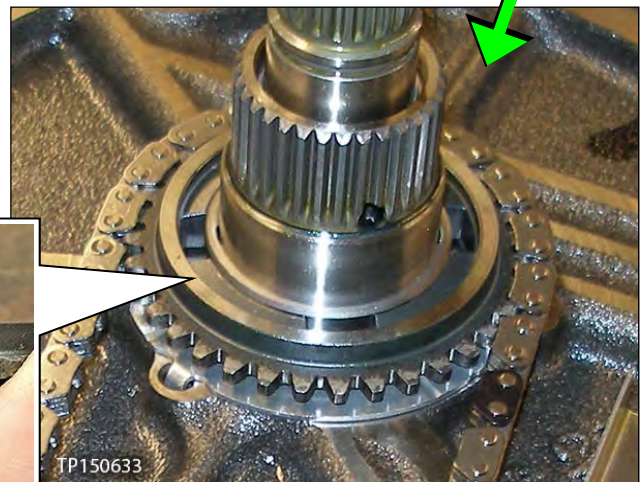
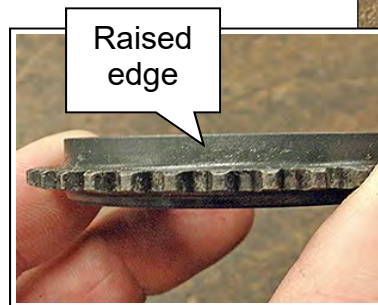

Figure 139

- Expand the snap ring with a suitable tool, and then push down on the driven sprocket until it bottoms out (Figure 140).
- Release the snap ring and then pull up on the driven sprocket until the snap ring locks into its groove.

NOTE: A click sound is heard when the snap ring locks in place.

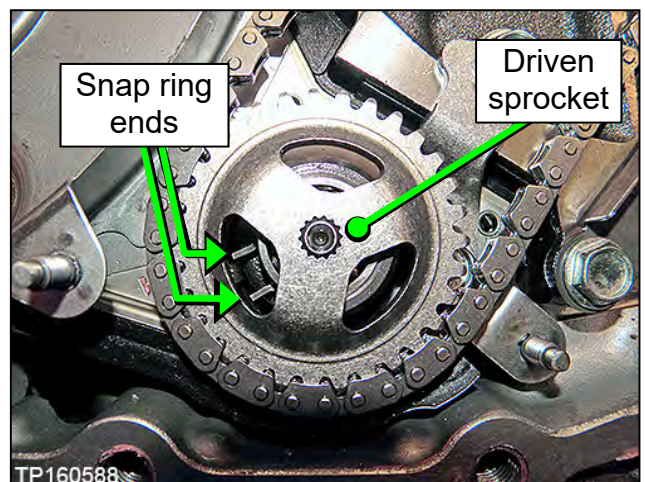

Figure 140

108. Install baffle plate A with two nuts (Figure 141).

- Nut torque: 5.9 N•m (0.6 kg-m, **52.2 in-lb.**)

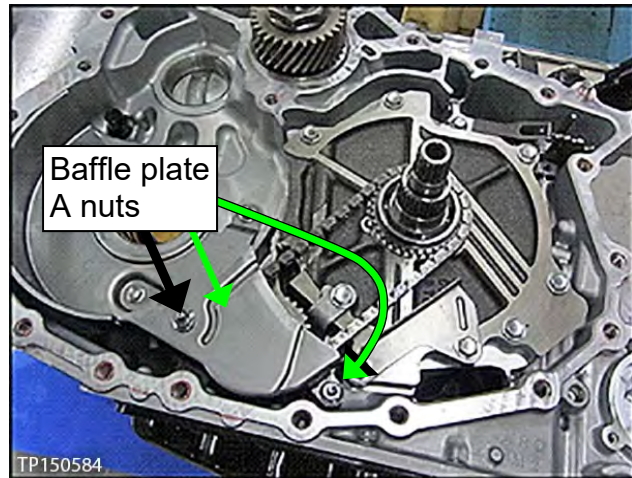

Figure 141

109. Install a new O-ring on the input shaft (Figure 142).

- Apply CVT fluid to the O-ring and O-ring groove before installing.

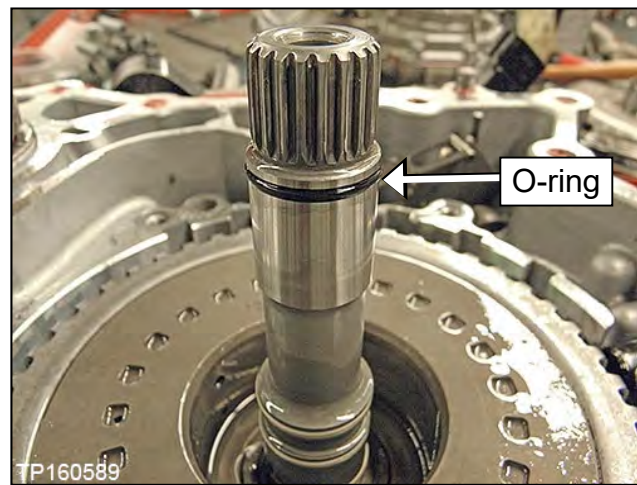

Figure 142

110. Install the differential assembly and the reduction gear assembly into the CVT case (Figure 143 and Figure 144).

- Thoroughly clean each assembly before installing.
- Oil the bearings and gear teeth with CVT fluid before installing.

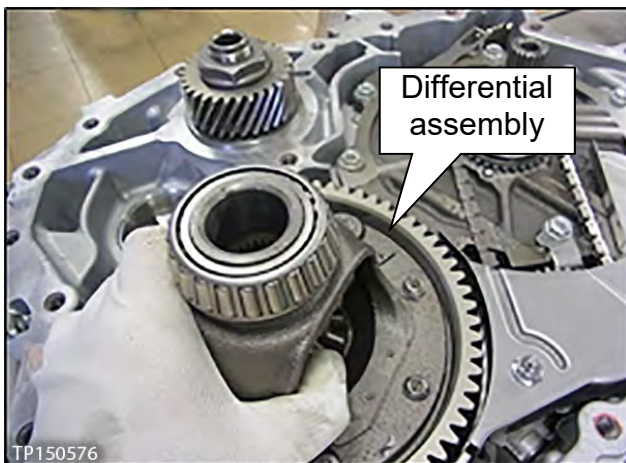

Figure 143

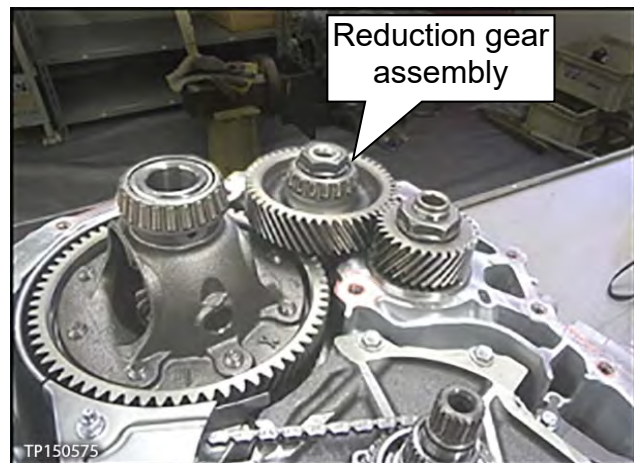

Figure 144

111. Install the CVT fluid filter and components (Figure 145 and Figure 146).

- Install a new filter with grommet (one part).
- Install a new O-ring.
- Confirm that all components and areas where components fit are thoroughly clean.
- Apply CVT fluid to the grommet seal and O-ring before installing.
- Install the filter cover.
 - Bolt torque 4.2 N•m (0.43 kg-m, **37.2 in-lb.**)

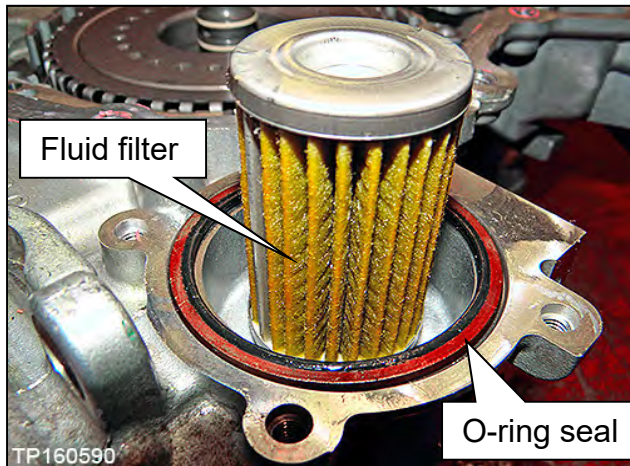

Figure 145

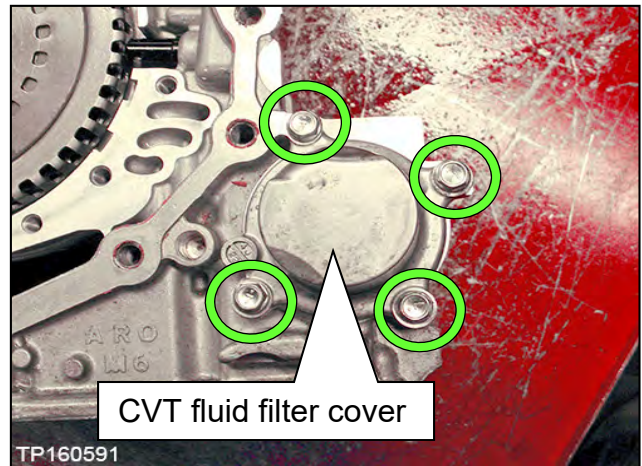

Figure 146

112. Confirm the pin (Figure 147) is located in the CVT case prior to installation of the converter housing.

NOTE: Apply petroleum jelly or equivalent to keep it in place if necessary.

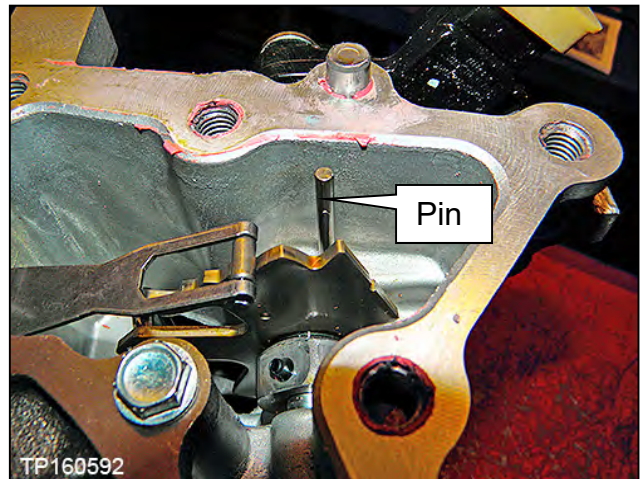

Figure 147

113. Apply one continuous 2.0 mm (**0.8 inches**) diameter bead (Figure 148) of pink colored Loctite 5460 Sealant (see **PARTS INFORMATION** on page 91).

- Before sealant application, make sure the mating surfaces are clean from oil, dirt, old sealant, etc. (Figure 148).

IMPORTANT: Have the converter housing ready for installation prior to applying the sealant.

NOTE:

- Start applying sealant where shown, making sure that the starting point and the ending point are about the middle between the bolt holes.
- Overlap both ends of the bead by 3-5 mm (**0.12-0.20 inches**).
- Make sure to apply sealant around the center bolt hole.

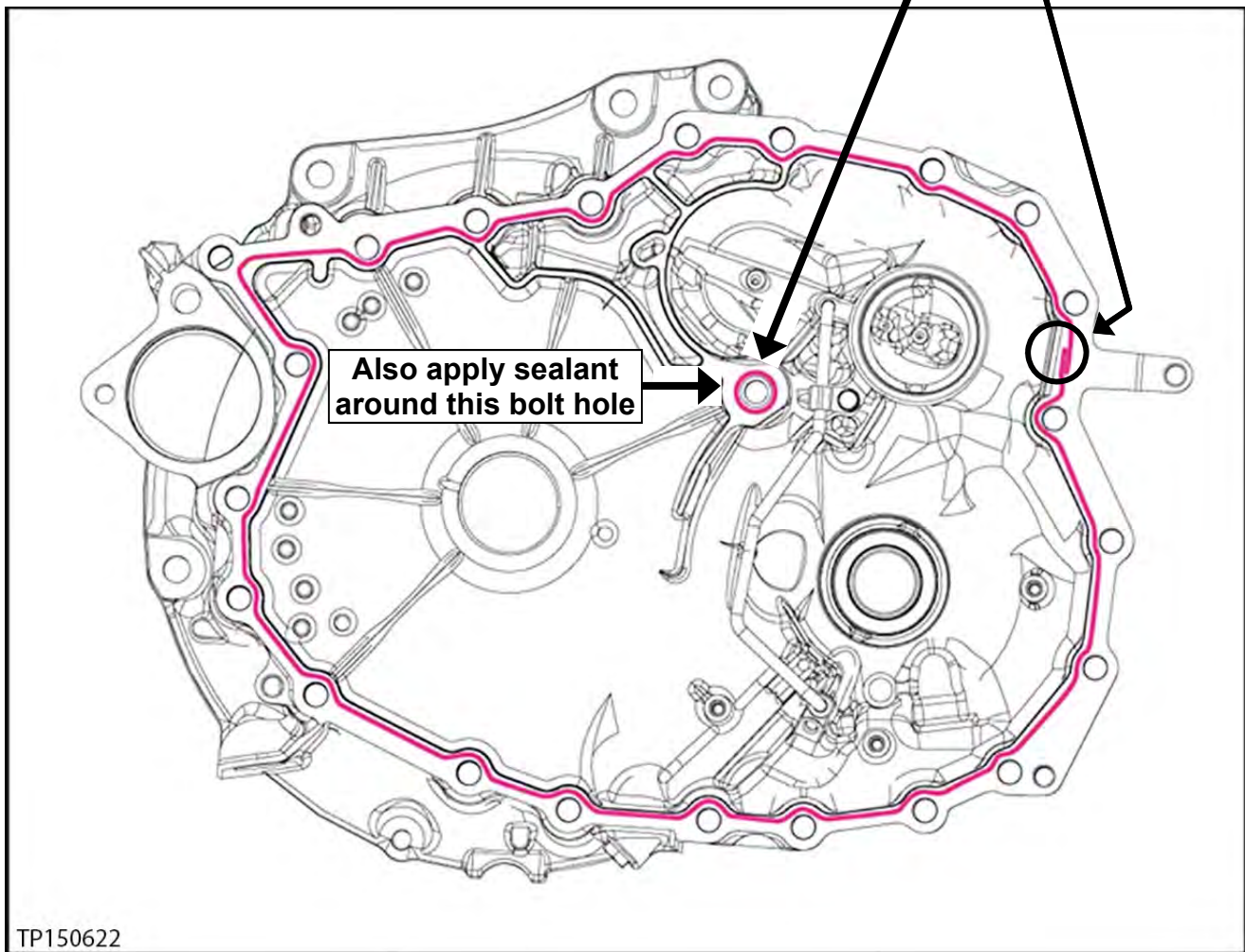





Figure 148

TP150622

114. Install the converter housing onto the CVT case (see Figure 149 for torque sequence):

- Install the 23 new bolts.
 - a. Torque the first six (6) bolts with symbol  in numbered sequence (see below).
 - b. Torque the remaining bolts with symbol  in numbered sequence (see below).
 - Use a short socket on the bolts indicated by this symbol: 
 - All bolts are 30 mm (1.2 inches) in length.
 - Bolt torque: 45.0 N•m (4.6 kg-m, 33.2 ft-lb.)

IMPORTANT: Make sure to torque the bolts in the sequence shown (Figure 149).

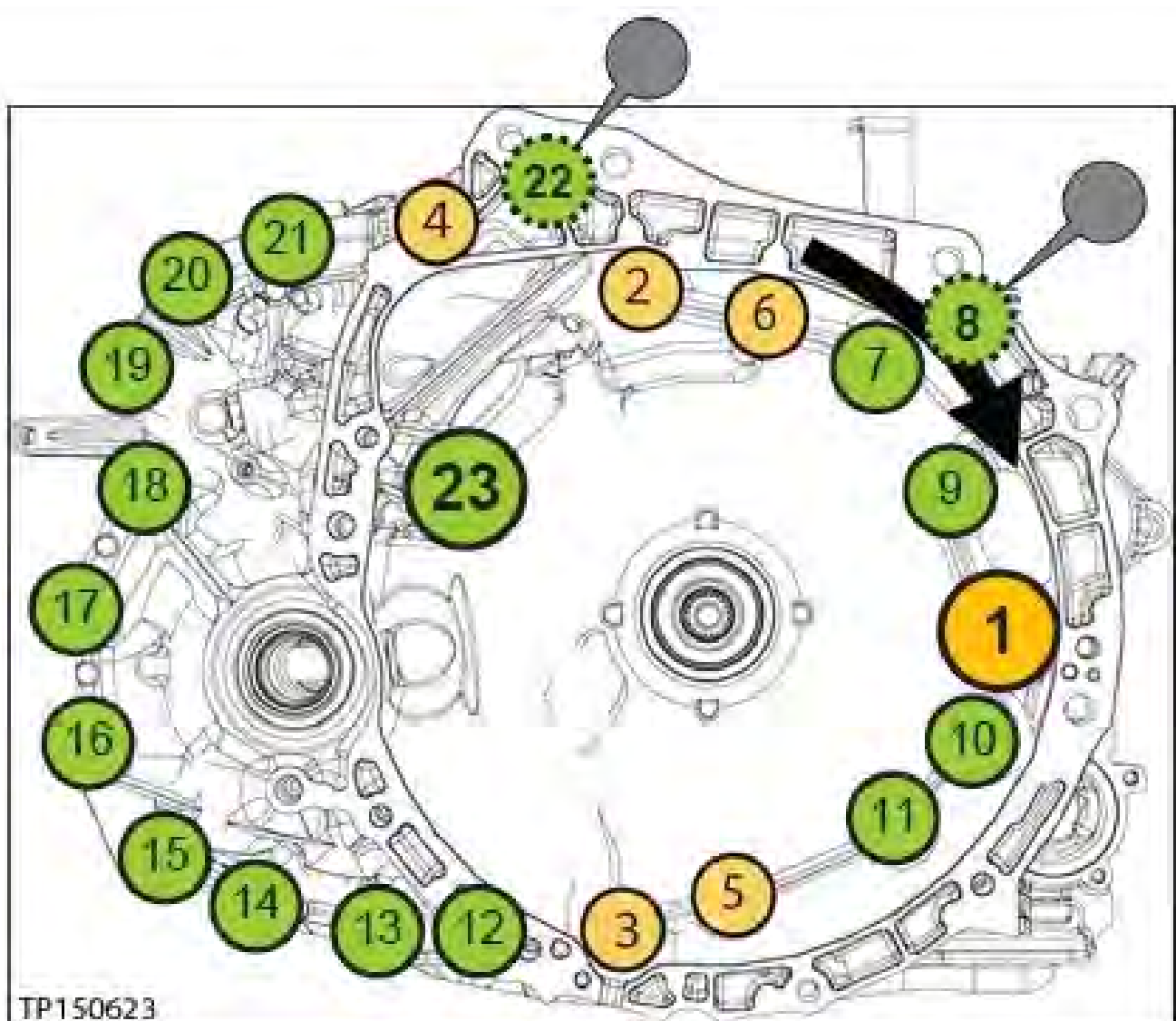

Figure 149

115. Clean off the excess sealant.

Control Valve Strainer and Pan Installation

IMPORTANT:

- Installation steps in this bulletin may contain different style parts than what were originally installed in the CVT. Pay careful attention, REASSEMBLY MAY NOT BE IDENTICAL TO DISASSEMBLY.
- **Confirm that the QR label, control valve and CD part numbers all match before installing the control valve** (refer to NTB12-103).
- For additional information, see video # 547: “CVT Belt and Pulley Replacement” and fast forward to minute marker 20:09. This video is located under the TECH TRAINING GARAGE VIDEOS tab in Virtual Academy.

CAUTION: Handle the control valve carefully.

NOTE: If an oil strainer bracket was removed, discard it. An oil strainer bracket (Figure 150) will not be used with the new oil strainer.



Figure 150

116. Install a new lip seal (Figure 151).

- Do NOT reuse the old lip seal.
- Apply a small amount of petroleum jelly or equivalent to the lip seal to keep it in place on the CVT.

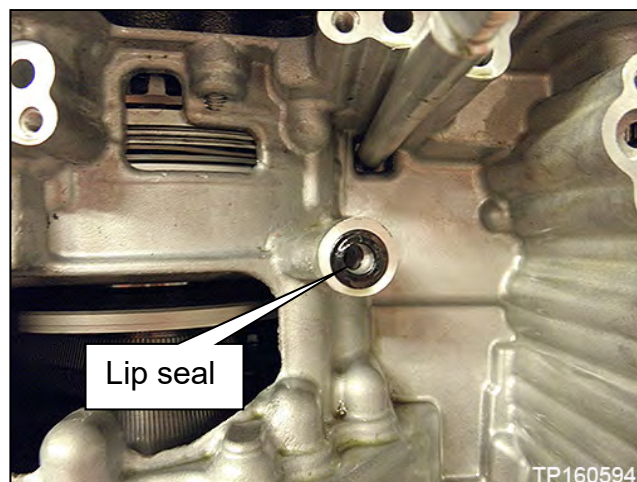





Figure 151

117. Install the Control Valve with eleven (11) mounting bolts (Figure 152).

IMPORTANT: Leave four (4)  bolt holes empty at this step.

CAUTION: Make sure the wiring harness is not pinched (see Figure 153 and Figure 154 for correct routing).

- 54 mm (2.125 inches) long bolt  ; 7 pieces
- 44 mm (1.73 inch) long bolt  ; 2 pieces
- 25 mm (1 inch) long bolt  ; 2 pieces

CAUTION: The two 25 mm bolts are installed WITHOUT the strainer bracket.

➤ Bolt torque: 7.9 N•m (0.81 kg-m, 70 in-lb.)

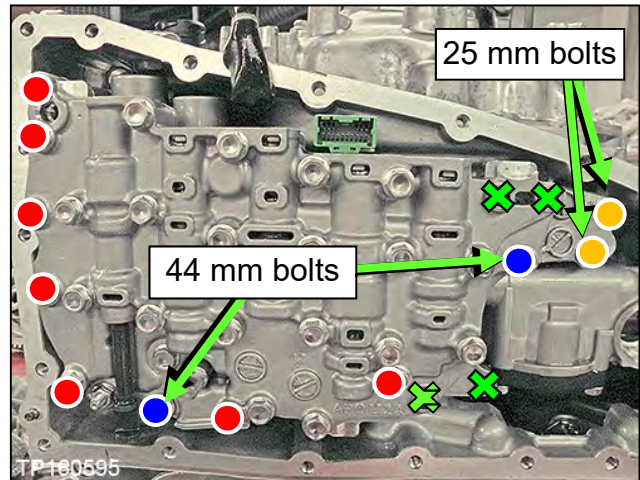

Figure 152

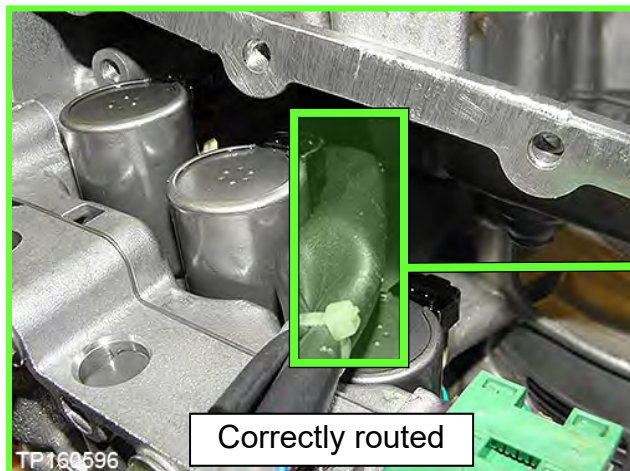

Figure 153

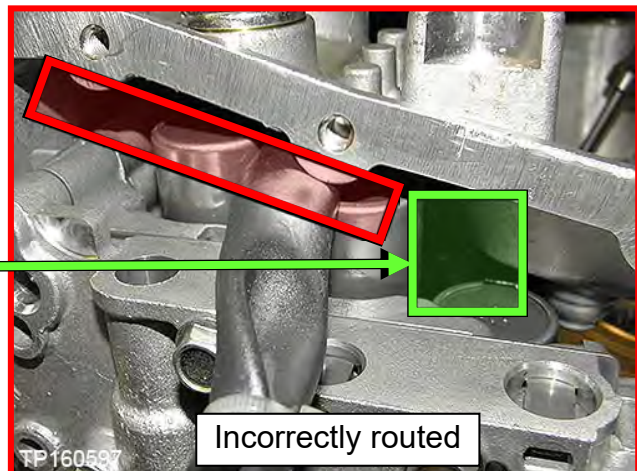

Figure 154

118. Replace the metal bracket of the fluid temperature sensor as follows:

NOTE: The new bracket will be oriented the same way the old bracket was.

- a. Cut the old plastic zip tie with an appropriate tool to remove the fluid temperature sensor's metal bracket from the terminal harness assembly (Figure 155 and Figure 156).

CAUTION: Cut the plastic zip tie over the metal bracket to avoid damage to the fluid temperature sensor.

- b. Discard the removed metal bracket and plastic zip tie.
- c. Use the new plastic zip tie from the **PARTS INFORMATION** on page 91 to attach the fluid temperature sensor of the terminal connector harness to the fluid temperature sensor's new metal bracket.

IMPORTANT:

- Secure the plastic zip tie at the center notch of three notches on the fluid temperature sensor (Figure 155).
 - Tighten the plastic zip tie so that it is oriented as shown in Figure 156.
- d. Cut off the plastic zip tie excess.

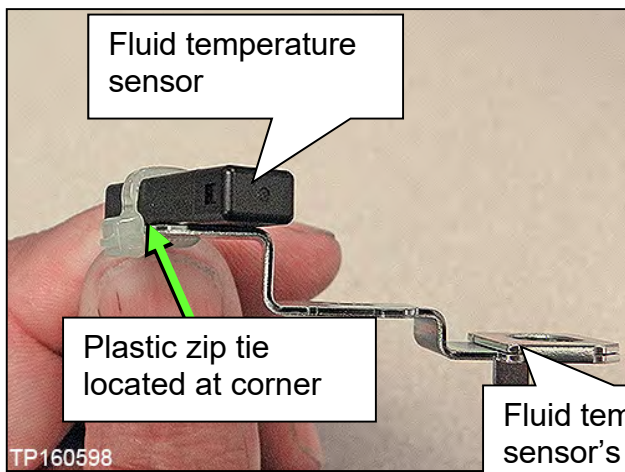

Figure 155

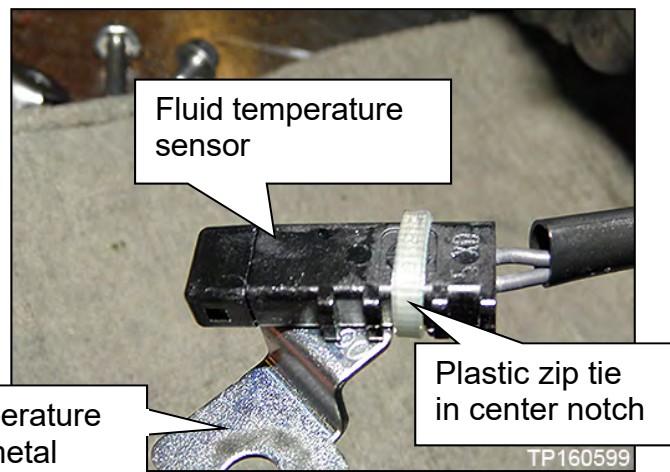

Figure 156

119. Connect the electrical harness connector (Figure 157).

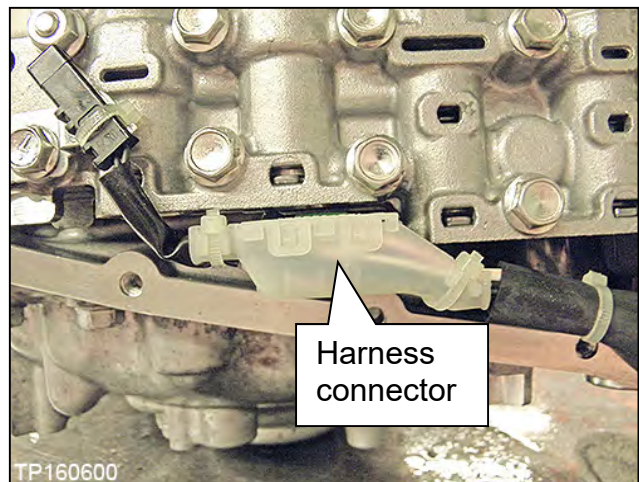

Figure 157

120. Install the CVT fluid temperature sensor bracket to the control valve with one (1) bolt (Figure 158).

NOTE: Leave one (1) bolt hole empty as it will be used to secure the oil strainer at a later step.

- 54 mm (2.125 inches) long bolt.
 - Bolt torque: 7.9 N•m (0.81 kg-m, 70 in-lb.)

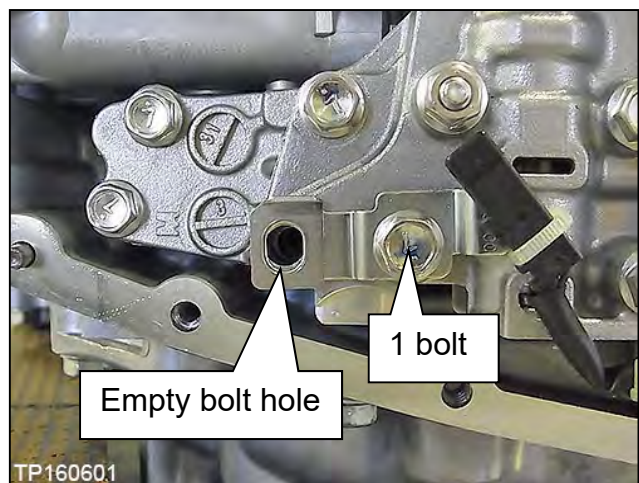



Figure 158

121. Install the new oil strainer with its new O-ring seal with two (2) bolts (Figure 159).

NOTE: The replacement strainer maybe a different shape than the original.

- 54 mm (2.125 inches) long bolt ; 2 pieces.
 - Bolt torque: 7.9 N•m (0.81 kg-m, 70 in-lb.)

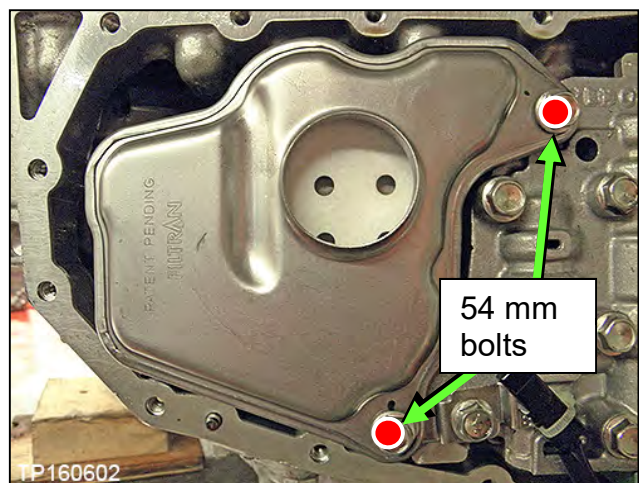

Figure 159

122. Install the manual plate, lock washer, and nut (Figure 160).

NOTE: Make sure the manual plate fits into the slot of the manual valve before applying torque to the nut.

- Reuse the existing manual plate, lock washer, and nut.
 - Nut torque: 22.1 N•m (2.3 kg-m, **16 ft-lb.**)

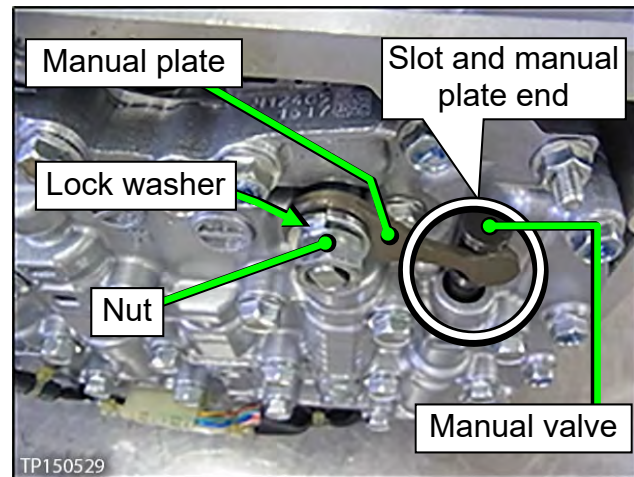

Figure 160

123. Clean the original oil pan and magnets with a suitable cleaner. Visible debris should not be present at reassembly.

124. Reassemble the original magnets to their original locations on the oil pan.

125. Install a new oil pan gasket to the oil pan.

126. Install the oil pan bolts (see Figure 161).

- Reuse the existing oil pan bolts.
 - Oil pan bolt torque: 7.9 N•m (0.81 kg-m, **70 in-lb.**)

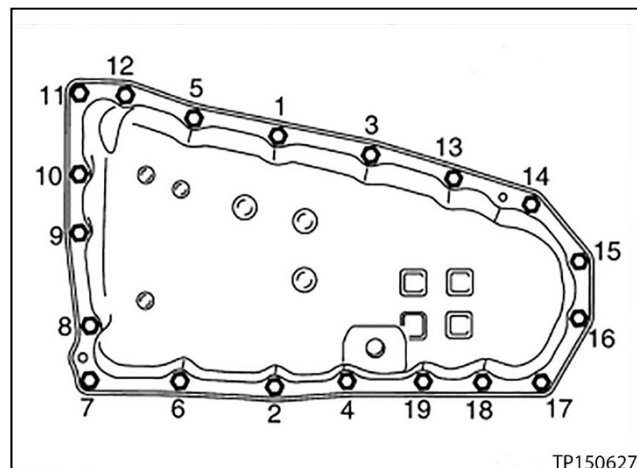

Figure 161

127. Install a new drain plug washer to the drain plug on the oil pan.

128. Install the primary speed sensor to the CVT assembly.

IMPORTANT: Install a new O-ring to the speed sensor before installation. DO NOT reuse the old O-ring.

- Bolt torque: 5.9 N•m (0.6 kg-m, **52 in-lb.**)

129. Install the torque converter to the CVT assembly.

- Verify the torque converter is installed at the proper depth (see Figure 162).
- \textcircled{A} = 14.4 mm

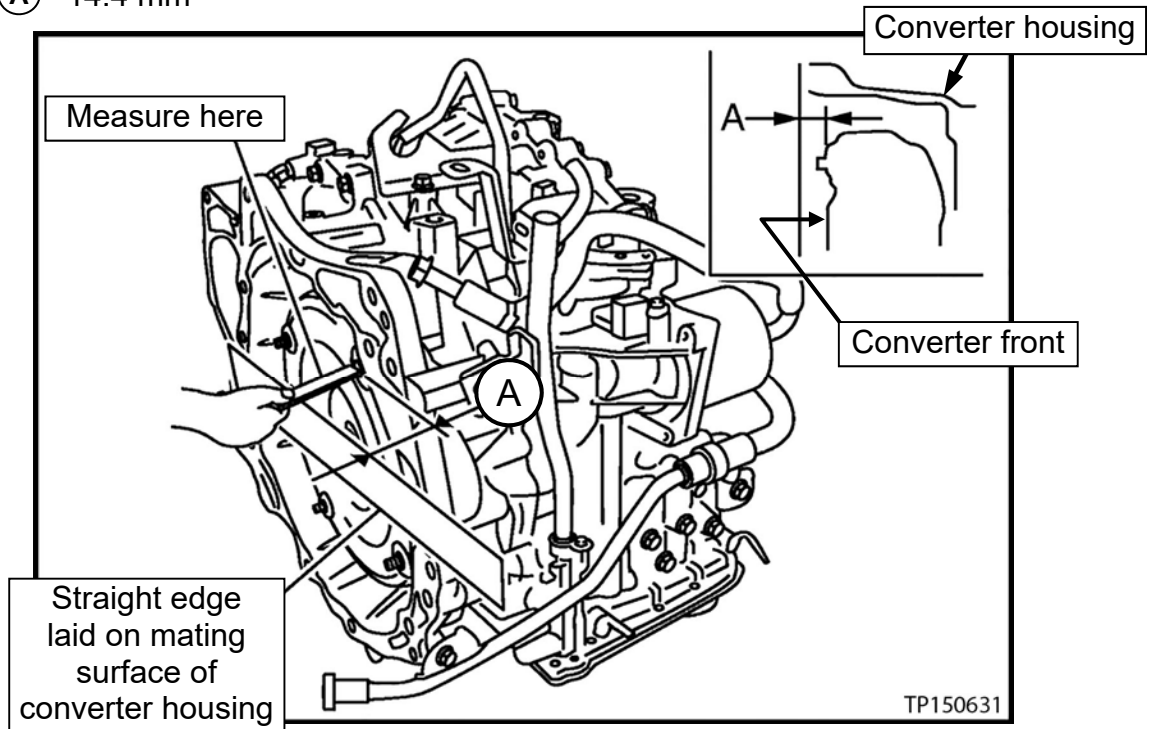

Figure 162

130. Attach the QR label (Figure 163) with the new calibration data onto the transmission range switch (inhibitor switch; Figure 164).

- A QR Label and CD-R are included with the new control valve.

131. Confirm that the QR label and the CD-R part numbers are the same (Figure 164).

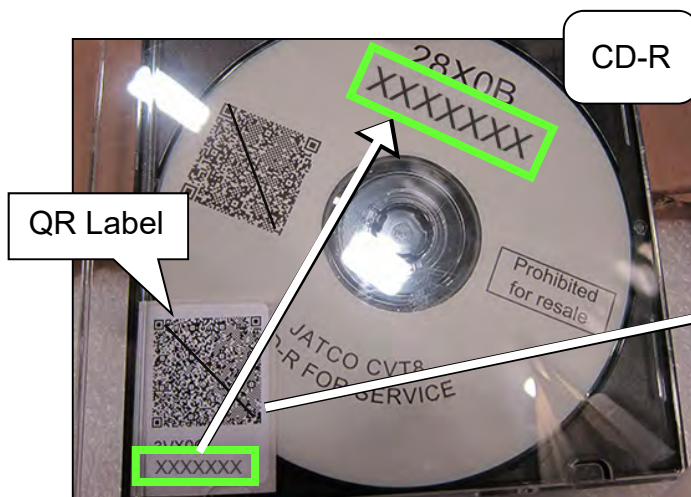

Figure 163

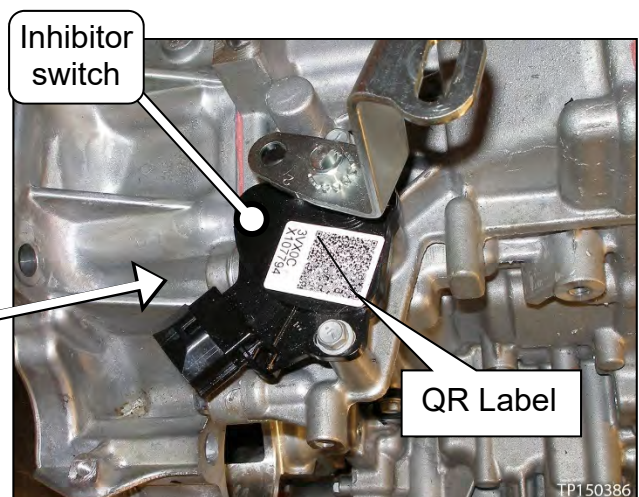

Figure 164

Install the CVT Assembly

132. Install the CVT assembly into the vehicle.

- Skip to TCM Reprogramming on the next page if the belt inspection was OK in step 8.
- Refer to the ESM, section **Transaxle & Transmission**, for CVT installation.

133. Flush the CVT cooler.

IMPORTANT: A CVT Cooler flush is required. Refer to the ESM for CVT cooler flush.

TRANSAXLE & TRANSMISSION > CVT: RE0F10D > BASIC INSPECTION > CVT FLUID COOLER SYSTEM > CLEANING

134. Connect both battery cables, negative cable last.

135. Reset/reinitialize systems as needed.

- Refer to the ESM for a listing of systems that require reset/initialization after reconnecting the 12V battery:

ELECTRICAL & POWER CONTROL > POWER SUPPLY, GROUND & CIRCUIT ELEMENTS > BASIC INSPECTION > INSPECTION AND ADJUSTMENT > ADDITIONAL SERVICE WHEN REMOVING BATTERY NEGATIVE TERMINAL

TCM Reprogramming

IMPORTANT: Repairs performed for this bulletin require CONSULT-III plus (C-III plus) Diagnostic result reporting function-Setting be turned ON and Diagnosis (All Systems) be performed. If not done, it may result in a repair being non-warrantable.

IMPORTANT: Before starting, make sure:

- ASIST on the CONSULT PC has been synchronized (updated) to the current date.
- All C-III plus software updates (if any) have been installed.
- The CONSULT PC is connected to the Internet (Wi-Fi or cable).

NOTE:

- Most instructions for reprogramming with C-III plus are displayed on the CONSULT PC screen.
- If you are not familiar with the reprogramming procedure, [click here](#). This will link you to the "CONSULT- III plus (C-III plus) Reprogramming" general procedure.

CAUTION:

- Connect a battery maintainer or smart charger set to reflash mode or a similar setting. If the vehicle battery voltage drops below 12.0V or rises above 15.5V during reprogramming, the TCM may be damaged.
- Be sure to turn OFF all vehicle electrical loads. If a vehicle electrical load remains ON, the TCM may be damaged.
- Be sure to connect the AC Adapter. If the CONSULT PC battery voltage drops during reprogramming, the process will be interrupted and the TCM may be damaged.
- Turn OFF all external Bluetooth® devices (e.g., cell phones, printers, etc.) within range of the CONSULT PC and the plus VI. If Bluetooth® signal waves are within range of the CONSULT PC or plus VI during reprogramming, reprogramming may be interrupted and the TCM may be damaged.

136. Connect the CONSULT PC to the vehicle to begin the reprogramming procedure.

137. Start C-III plus.

138. Wait for the plus VI to be recognized.

- The serial number will display when the plus VI is recognized.

139. Select **Re/programming, Configuration**.

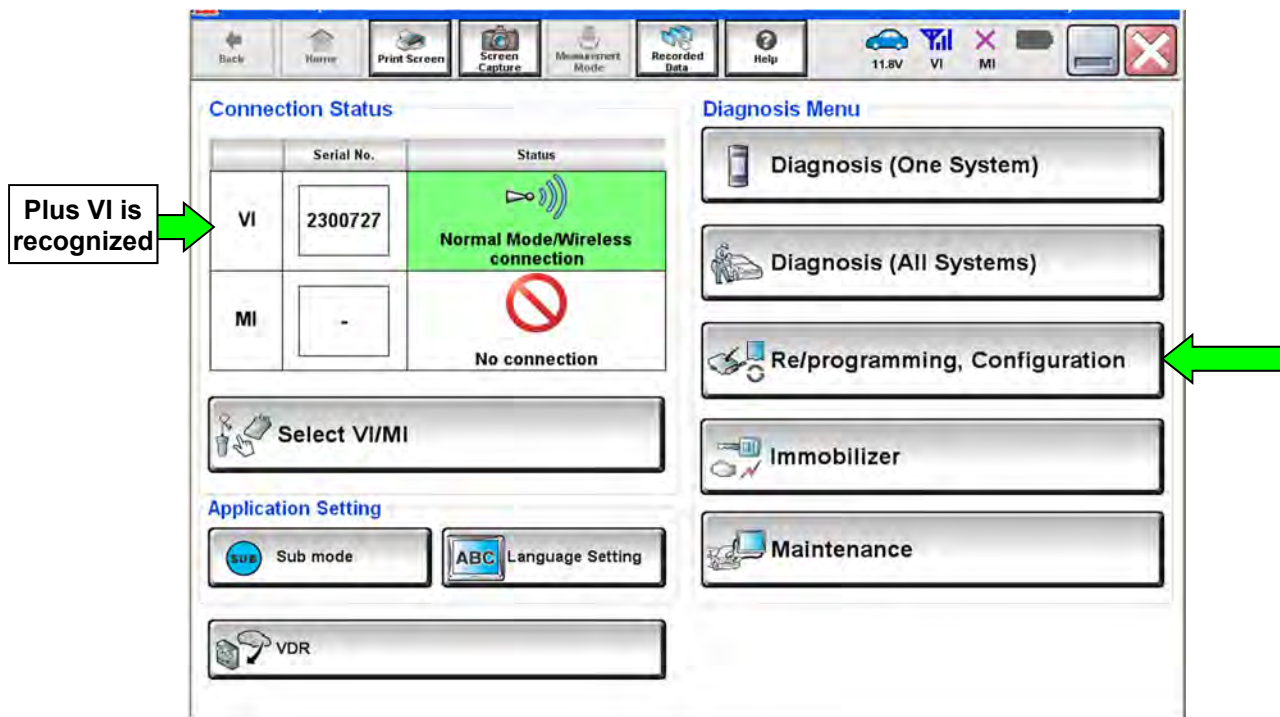

Figure 165

140. Follow the on-screen instructions and navigate the C-III plus to the screen shown in Figure 166 on the next page.

141. When you get to the screen shown in Figure 166, confirm reprogramming applies as follows.

A. Find the TCM **Part Number** and write it on the repair order.

NOTE: This is the current TCM Part Number (P/N).

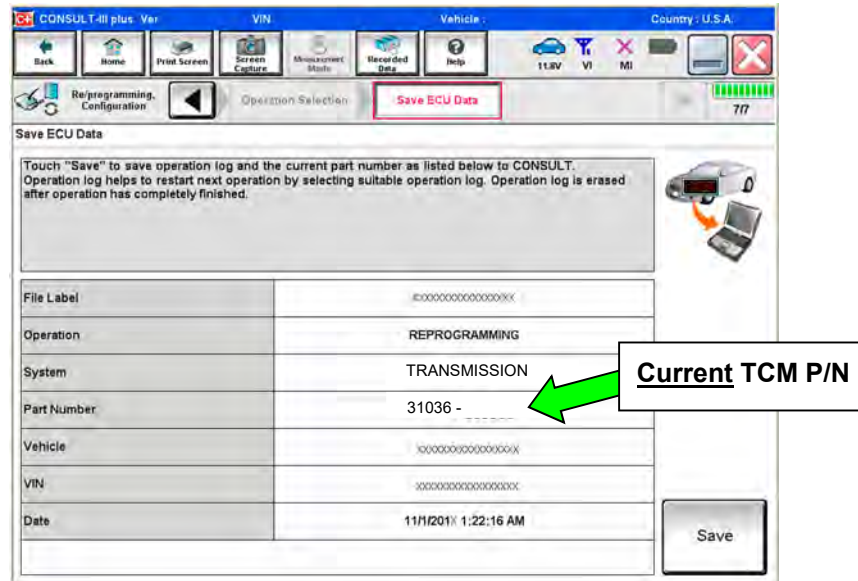

Figure 166

B. Compare the P/N you wrote down to the numbers in the **Current TCM Part Number** column in **Table B** below.

- If there is a match, continue with the reprogramming procedure; step 142.
- If there is not a match, reprogramming is not needed; skip to step 151 and perform **ADDITIONAL SERVICE WHEN REPLACING CONTROL VALVE**.

Table B

| MODEL | MODEL YEAR | CURRENT TCM PART NUMBER BEFORE REPROGRAMMING: 31036 - |
|-------|------------|---|
| NV200 | 2015 | 9SB0C, 9SD0C |
| | 2016 | 9SE0C, 9SE2C |
| | 2017 | 9SF0A, 9SF2A |
| | 2018 | 9SJ0A, 9SJ2A |
| Taxi | 2014 | 3LN0B |
| | 2015 | 9SC0A |
| | 2016 | 9SH0B |
| | 2017 | 9SG0A |

142. Follow the on-screen instructions to navigate C-III plus and reprogram the TCM.

NOTE:

- In some cases, more than one new P/N for reprogramming is available.
 - If more than one new P/N is available, the screen in Figure 167 displays.
 - Select and use the reprogramming option that does **not** have the message “Caution! Use ONLY with NTBXX-XXX”.
- If you get this screen and it is blank (no reprogramming listed), it means there is no reprogramming available for this vehicle.

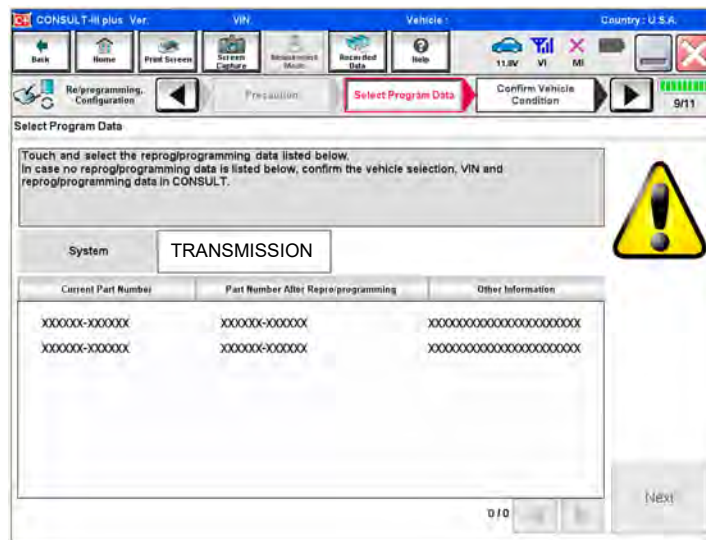

Figure 167

- Before reprogramming will start, you will be required to enter your User Name and Password.
 - The CONSULT PC must be connected to the Internet (Wi-Fi or cable).
 - If you do not know your User Name and Password, contact your Service Manager.

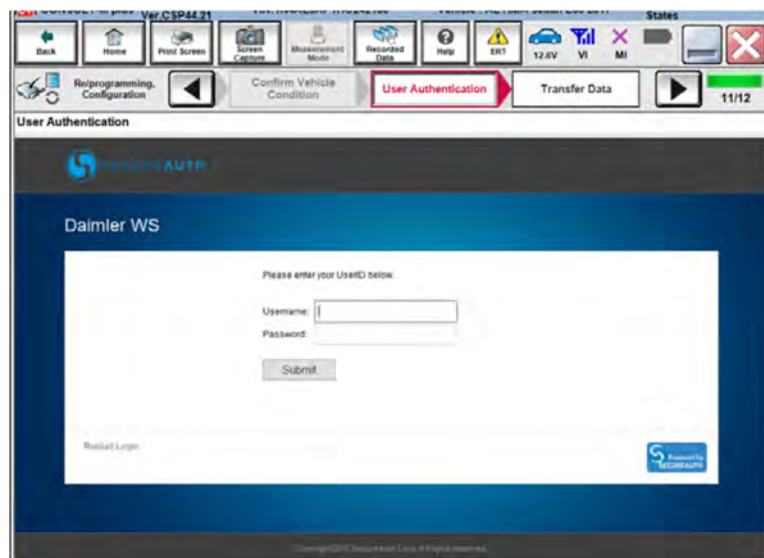

Figure 168

143. When the screen in Figure 169 displays, reprogramming is complete.

NOTE: If the screen in Figure 169 does not display (indicating that reprogramming did not complete), refer to the information on the next page.

144. Disconnect the battery maintainer/smart charger from the vehicle.

145. Select **Next**.

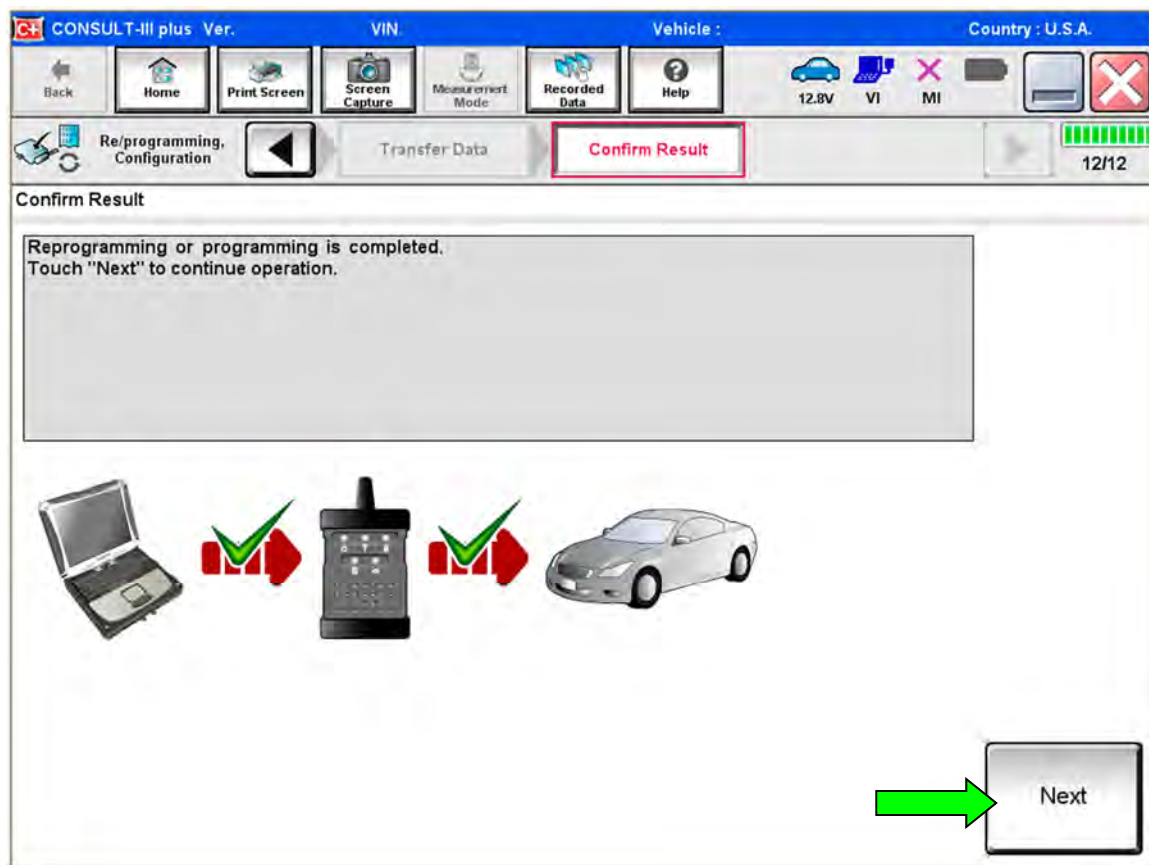

Figure 169

NOTE:

- In the next step (page 85) you will perform **Erase All DTCs**.
- DTC erase is required before C-III plus will provide the final reprogramming confirmation report.

TCM Recovery:

Do not disconnect plus VI or shut down C-III plus if reprogramming does not complete.

If reprogramming does not complete and the “!?” icon displays as shown in Figure 170:

- Check battery voltage (12.0–15.5 V).
- Ignition is ON, engine OFF.
- External Bluetooth® devices are OFF.
- All electrical loads are OFF.
- **Select retry and follow the on screen instructions.**
- “Retry” may not go through on first attempt and can be selected more than once.

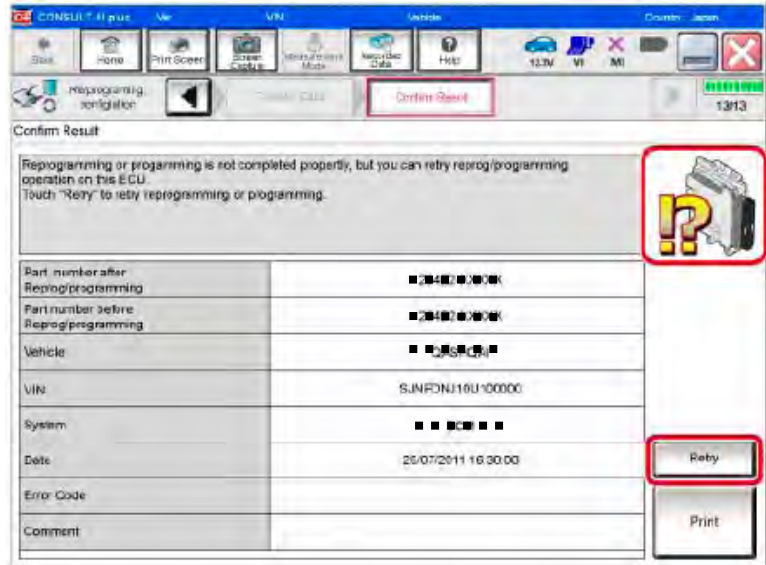

Figure 170

If reprogramming does not complete and the “X” icon displays as shown in Figure 171:

- Check battery voltage (12.0 – 15.5 V).
- CONSULT A/C adapter is plugged in.
- Ignition is ON, engine OFF.
- Transmission is in Park.
- All C-III plus / VI cables are securely connected.
- All C-III plus updates are installed.
- **Select Home, and restart the reprogram procedure from the beginning.**

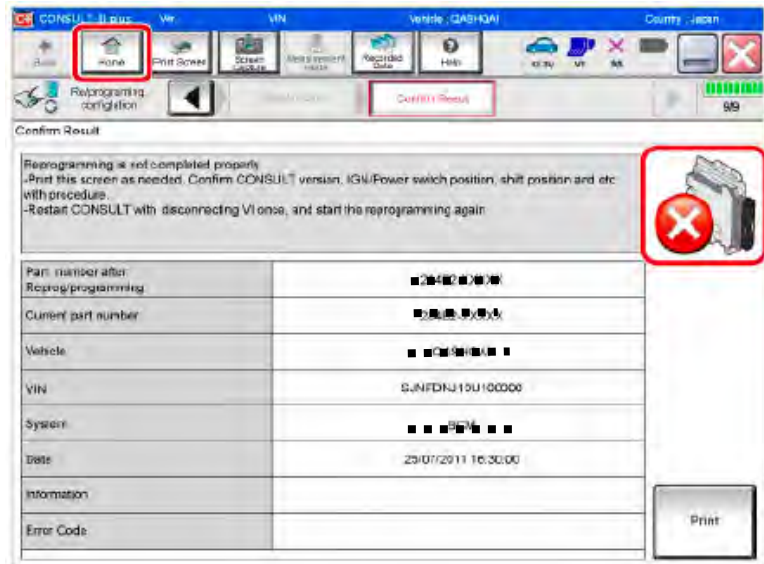

Figure 171

- 146. Follow the on-screen instructions to **Erase All DTCs**.
- 147. When the entire reprogramming process is complete, the screen in Figure 172 will display.
- 148. Verify the before and after part numbers are different.
- 149. Print a copy of this screen (Figure 172) and attach it to the repair order for warranty documentation.
- 150. Select **Confirm**.

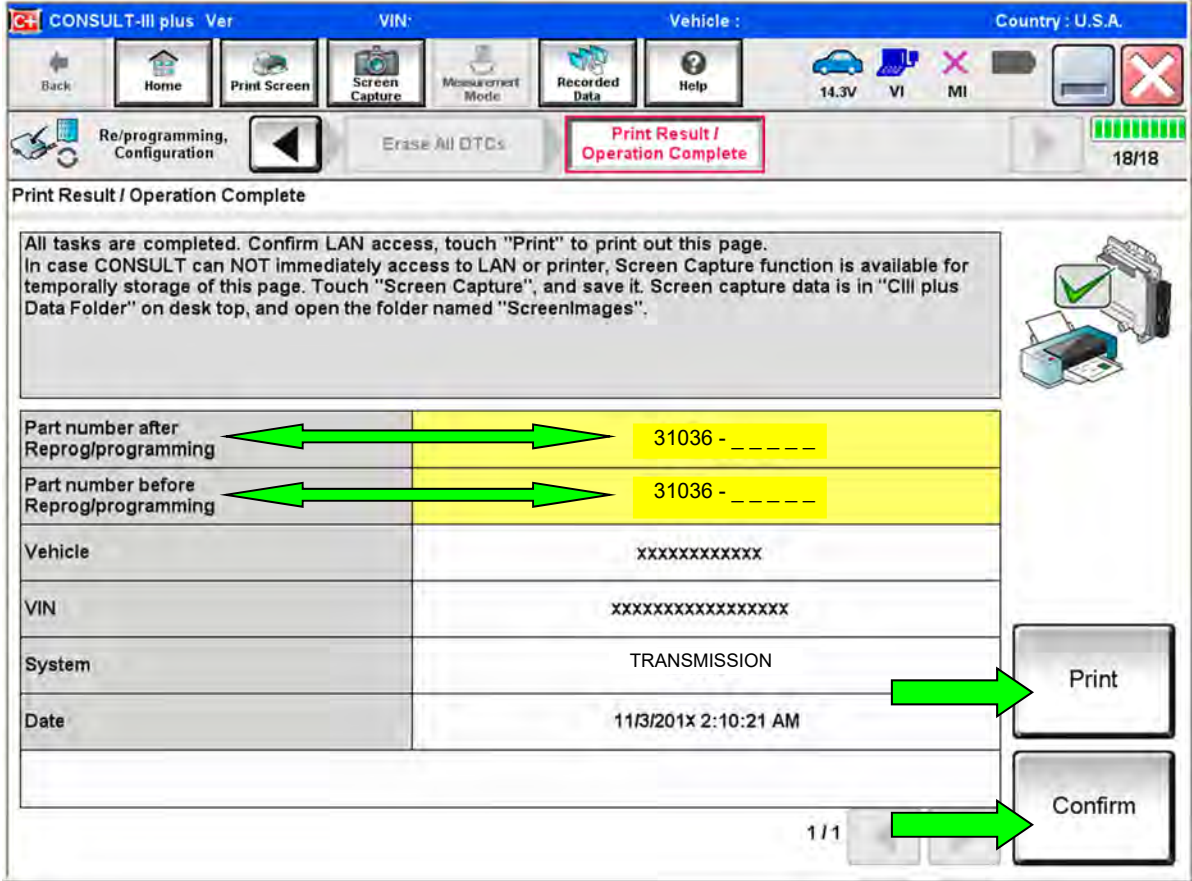

Figure 172

ADDITIONAL SERVICE WHEN REPLACING CONTROL VALVE

NOTE: Steps 151-194 are additional services that must be performed after replacing the control valve.

Print Current Calibration Data

151. Select 'CALIB DATA" in "TRANSMISSION."

152. Print page 1 of 7 and attach it to the repair order.

Check the Serial Number

153. Write down the serial number (calibration file number) of the new control valve.

154. Compare the serial number (calibration file number) on the CD, QR code label and new control valve. All numbers must match.

155. Insert the supplied CD into CONSULT.

156. Select "Work Support" in "TRANSMISSION".

157. Select "WRITE IP CHARA - REPLACEMENT AT/CVT".

158. Select "OK" on the "Select IP characteristics data file" window.

159. Open the calibration file located on the supplied CD.

160. Confirm that the serial number (calibration file number) displayed on the CONSULT screen matches the serial number (calibration file number) on the new control valve.

161. Select "Next" on the "WRITE IP CHARA - REPLACEMENT AT/CVT" Work Support screen.

Write the Data (Write IP Chara)

162. With the ignition on and the engine off, press the brake pedal.

163. Shift the selector lever to the R position.

164. Depress the throttle pedal half way and hold, then press "START" on the CONSULT screen.

165. Write data to the TCM according to the instructions on the CONSULT screen.

NOTE: When the calibration data has been written to the TCM, the current status will indicate "Complete".

166. Select "End".

Print New Calibration Data

167. Select “CALIB DATA” in “TRANSMISSION”.
168. Print page 1 of 7 and attach it to the repair order.
169. Return C-III plus to the Home screen.

FWD Clutch Point Learning

170. Apply the vehicle’s parking brake.
171. Start the engine and warm up to operating temperature (50-100° C [122-212° F]).

172. Select **Diagnosis (One System)**.

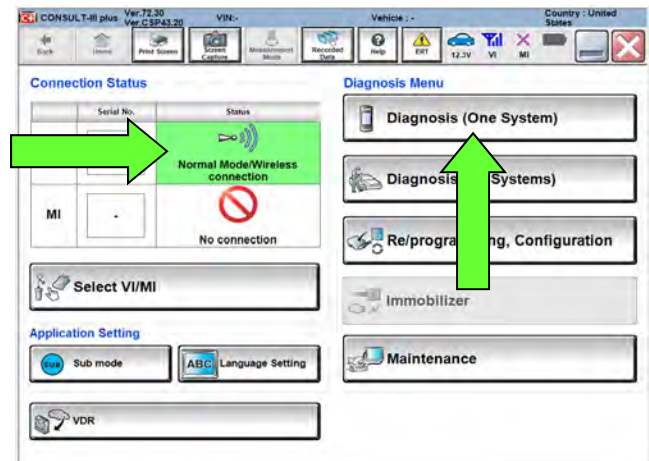

Figure 173

173. Select **Work Support** under TRANSMISSION.

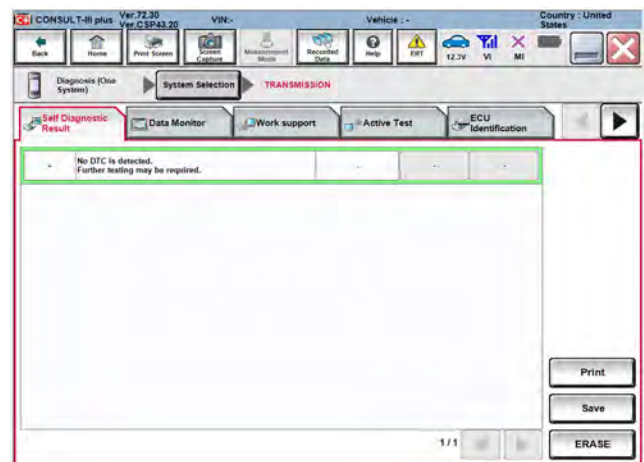

Figure 174

IMPORTANT: The following **FWD CLUTCH POINT LEARNING** will be performed twice; once in Drive (**D**) and once in Reverse (**R**).

174. Select **FWD CLUTCH POINT LEARNING** and then **Start**.

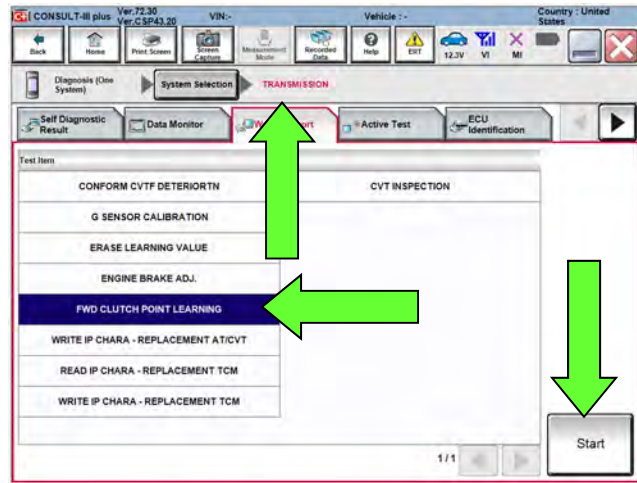

Figure 175

175. With the engine still running and at idle, depress the brake pedal and shift the CVT into neutral (**N**).

- Confirm that all of the required conditions indicated in Figure 176 are being met.

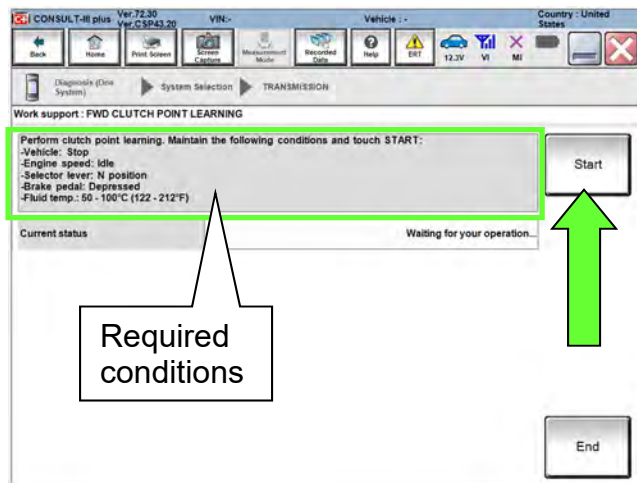

Figure 176

177. While maintaining all conditions shown in Figure 176 and the “Current status” indicates “EXECUTING”, shift the CVT into **D** and then wait until the Current status indicates “COMPLETED”.

NOTE: This may take up to three (3) minutes to complete.

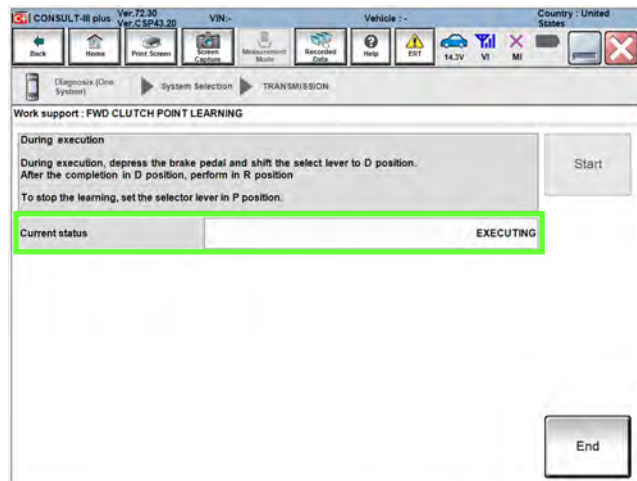

Figure 177

178. When the screen in Figure 178 is displayed, shift the CVT into **P**, and then select **End**.

179. Turn the engine OFF and then back ON.

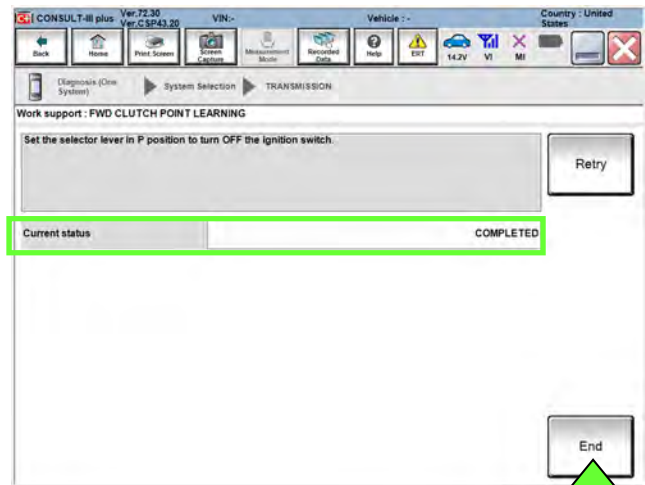

Figure 178

180. Select **FWD CLUTCH POINT LEARNING** and then **Start**.

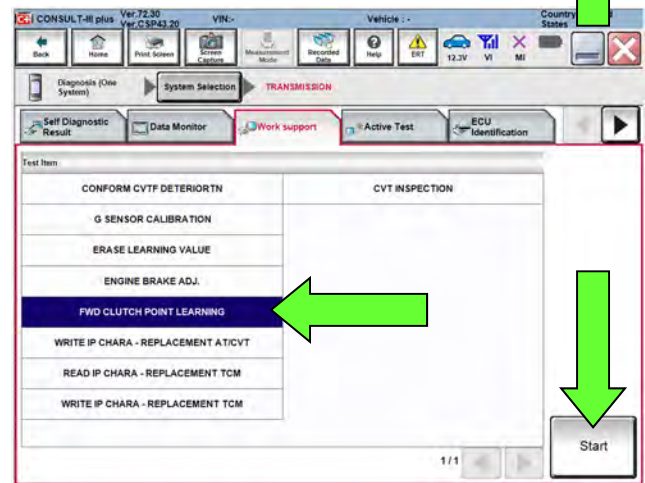

Figure 179

181. With the engine still running and at idle, depress the brake pedal and shift the CVT into neutral (**N**).

- Confirm that all of the conditions indicated in Figure 180 are being met.

182. Select **Start**.

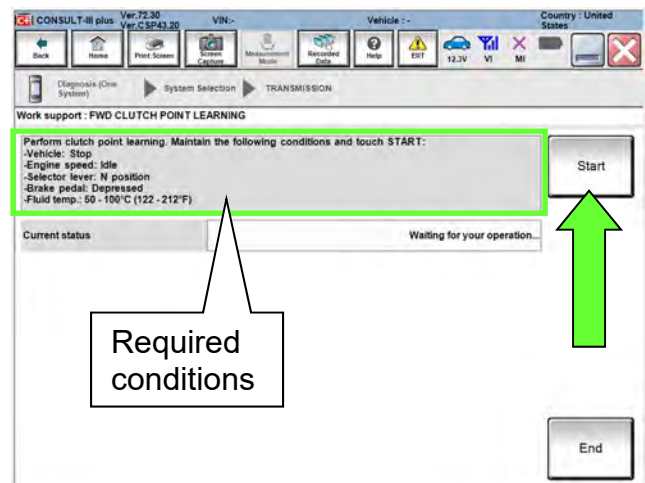

Figure 180

183. While maintaining all conditions shown in Figure 180 and the Current status indicates EXECUTING, shift the CVT into **R** and then wait until the Current status indicates COMPLETED.

NOTE: This may take up to 3 minutes to complete.

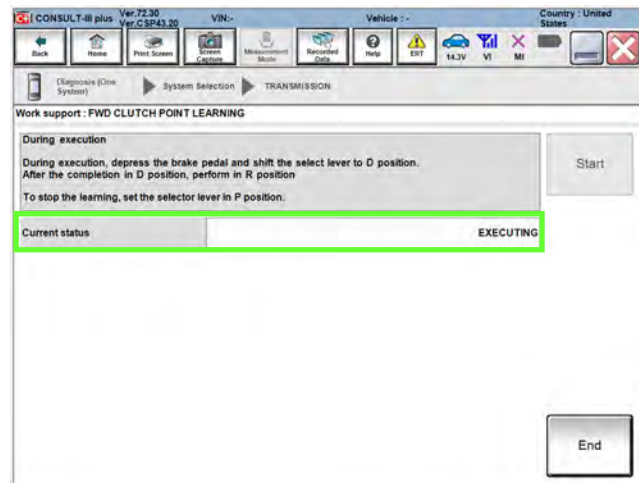

Figure 181

184. When the screen in Figure 182 is displayed select **End**, shift the CVT into **P**, and then turn the engine OFF.

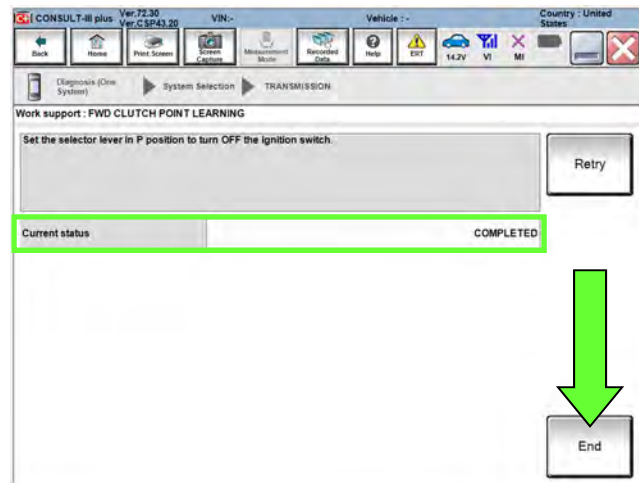

Figure 182

Perform Select Learning

185. Start the engine, and then wait five (5) seconds.
186. Move the shift selector to the **N** position and hold for more than two (2) seconds, and then move it to the **D** position and wait for transmission engagement.
187. Repeat step 186 ten times.
188. Move the shift selector to the **N** position and hold for more than 2 seconds, and then move it to the **R** position and wait for the transmission engagement.
189. Repeat step 188 ten times.
190. Move the shift selector to the **P** position, and then turn the ignition OFF.

Erase CVT Fluid Degradation Level Data

191. Select “Work Support” in “TRANSMISSION”.
192. Select “CONFORM CVTF DETERIORATION”.
193. Select “Clear”.
194. Clear any DTCs that may have set and then test drive the vehicle.

PARTS INFORMATION

If replacing the control valve and sub-assembly, use the following parts:

| DESCRIPTION | PART # | QUANTITY |
|--|---------------|-----------|
| BELT-PULLEY KIT | 31214-28X7A | 1 |
| CLAMP (Hose Spring Clamp) | 16439-7S01E | 2 |
| VALVE ASSY KIT-CONTROL (Control valve) | 3170E-28X0B | 1 |
| Valve Assy Kit-Control includes: | | |
| VALVE ASSEMBLY-CONTROL (1) | | 1 |
| STRAINER ASSY-OIL, AUTO TRANS | | 1 |
| BRACKET (Temperature sensor bracket) | | 1 |
| BAND (Zip tie for bracket) | | 1 |
| GSKT-OIL PAN | | 1 |
| SEAL-LIP (Between CVT and control valve) | | 1 |
| Seal, O-Ring (fluid filler plug gasket) | | 1 |
| WASHER-DRAIN (For drain plug) | 11026-JA00A | 1 |
| Loctite 5460 Sealant (2) (3) | 999MP-LT5460P | (4) |
| Nissan NS-3 CVT Fluid (2) (5) | 999MP-CV0NS3 | As needed |
| Transmission Cooler Cleaner (2) | 999MP-AM006P | As needed |
| Brake Cleaner (6) (7) | - | As needed |
| Petroleum Jelly (or equivalent) (7) | - | As needed |
| 90% Isopropyl Alcohol (7) | - | As needed |
| Lens Swab (7) (8) | J-51963 | As needed |

- (1) Includes QR label, CD-R, and control valve assembly.
- (2) This item can be ordered through the Nissan Maintenance Advantage program: Phone: 877-NIS-NMA1 (877-647-6621) or Website: Order via link on dealer portal www.NNAnet.com and click on the "Maintenance Advantage" link.
- (3) Bill out Loctite 5460 Sealant under **expense code 008**. Do not include the Loctite 5460 Sealant part number on the claim.
- (4) One container of Loctite 5460 Sealant is good for approximately 5 repairs. This sealant is not included in any kit.
- (5) For warranty repairs, Nissan NS-3 CVT Fluid **must** be used. For non-warranty repairs, Nissan NS-3 CVT Fluid or an equivalent is recommended.
- (6) Use brake cleaner or an equivalent solvent that complies with state and local regulations.
- (7) Shop supply.
- (8) Lens swabs are available from Tech•Mate online: www.nissantechmate.com. Or by phone: 1-800-662-2001.

REMINDER! When instructed to reference the ESM for a repair procedure, ensure one-time-use parts are replaced.

PARTS INFORMATION continued on next page.

PARTS INFORMATION continued

If replacing only the control valve, use the following parts:

| DESCRIPTION | PART # | QUANTITY |
|--|--------------|-----------|
| VALVE ASSY KIT-CONTROL (Control valve) | 3170E-28X0B | 1 |
| CLAMP (Hose Spring Clamp) | 16439-7S01E | 2 |
| Valve Assy Kit-Control includes: | | |
| VALVE ASSEMBLY-CONTROL (1) | | 1 |
| STRAINER ASSY-OIL, AUTO TRANS | | 1 |
| BRACKET (Temperature sensor bracket) | | 1 |
| BAND (Zip tie for bracket) | | 1 |
| GSKT-OIL PAN | | 1 |
| SEAL-LIP (Between CVT and control valve) | | 1 |
| Seal, O-Ring (fluid filler plug gasket) | | 1 |
| WASHER-DRAIN (For drain plug) | 11026-JA00A | 1 |
| Nissan NS-3 CVT Fluid (2) (3) | 999MP-CV0NS3 | As needed |
| Transmission Cooler Cleaner (2) | 999MP-AM006P | As needed |
| Petroleum Jelly (or equivalent) (4) | - | As needed |
| 90% Isopropyl Alcohol (4) | - | As needed |
| Lens Swab (4) (5) | J-51963 | As needed |

- (1) Includes QR label, CD-R, and control valve assembly.
- (2) This item can be ordered through the Nissan Maintenance Advantage program: Phone: 877-NIS-NMA1 (877-647-6621) or Website: Order via link on dealer portal www.NNAnet.com and click on the "Maintenance Advantage" link.
- (3) For warranty repairs, Nissan NS-3 CVT Fluid **must** be used. For non-warranty repairs, Nissan NS-3 CVT Fluid or an equivalent is recommended.
- (4) Shop supply.
- (5) Lens swabs are available from Tech•Mate online: www.nissantechmate.com. Or by phone: 1-800-662-2001.

REMINDER! When instructed to reference the ESM for a repair procedure, ensure one-time-use parts are replaced.

CLAIMS INFORMATION

If Belt Inspection is not Performed and Sub-Assembly is replaced

Submit a Primary Part (PP) type line claim using the following claims coding:

| OPERATION | PFP | OP CODE | SYM | DIAG | FRT |
|--|-----|---------|-----|------|-----|
| CVT R&R | (1) | JD01AA | ZE | 32 | (2) |
| | | JD023A | | | |
| CVT SUBASSEMBLY (WITH CONTROL VALVE R&I) RP | | JX50AA | | | 3.8 |
| Reprogram TCM (when applicable) | | JE99AA | | | (2) |

- (1) Reference the Parts Information Table and use the BELT-PULLEY KIT Part Number 31214-**** as the Primary Failed Part.
- (2) Reference the current Nissan Warranty Flat Rate Manual and use the indicated Flat Rate Time.

NOTE: FRT allows adequate time to access DTC codes. No other diagnostic procedures subsequently required. Do NOT claim any diagnostic OP Codes with this claim.

EXPENSE CODE

| EXPENSE CODE | DESCRIPTION | MAX AMOUNT |
|--------------|--------------|------------|
| 008 | 5460 Sealant | \$12.46 |

CLAIMS INFORMATION continued on the next page.

CLAIMS INFORMATION continued.

OR

If Belt Inspection is Performed and Sub-Assembly is replaced (belt inspection shows signs of belt slip, NG)

Submit a Primary Part (PP) type line claim using the following claims coding:

| OPERATION | PFP | OP CODE | SYM | DIAG | FRT |
|---------------------------------|-----|---------|-----|------|-----|
| CVT R&R | (1) | JD01AA | ZE | 32 | (2) |
| | | JD023A | | | |
| CVT BELT INSPECT AND C/V R&I | | JX36AA | | | 1.1 |
| CVT SUBASSEMBLY RP | | JX45AA | | | 3.0 |
| Reprogram TCM (when applicable) | | JE99AA | | | (2) |

- (1) Reference the Parts Information Table and use the applicable BELT-PULLEY KIT Part Number 31214-***** as the Primary Failed Part.
- (2) Reference the current Nissan Warranty Flat Rate Manual and use the indicated Flat Rate Time.

NOTE: FRT allows adequate time to access DTC codes. No other diagnostic procedures subsequently required. Do NOT claim any diagnostic OP Codes with this claim.

EXPENSE CODE

| EXPENSE CODE | DESCRIPTION | MAX AMOUNT |
|--------------|--------------|------------|
| 008 | 5460 Sealant | \$12.46 |

OR

If Only Control Valve is replaced:

Submit a Primary Part (PP) type line claim using the following claims coding:

| OPERATION | PFP | OP CODE | SYM | DIAG | FRT |
|--|-----|---------|-----|------|-----|
| Inspect CVT Chain, Chain = OK | (1) | JX37AA | ZE | 32 | 0.3 |
| Replace Control Valve | | JD48AA | | | (2) |
| Reprogram TCM (When Applicable) | | JE99AA | | | (2) |

- (1) Reference the Parts Information Table and use the VALVE ASSY KIT-CONTROL part number (31705-*****) as the Primary Failed Part.
- (2) Reference the current Nissan Warranty Flat Rate Manual and use the indicated Flat Rate Time.

NOTE: FRT allows adequate time to access DTC codes. No other diagnostic procedures subsequently required. Do NOT claim any diagnostic OP Codes with this claim.

Check off the parts as they are used in the Service Procedure and attach the completed form to the repair order.

PARTS KITS REFERENCE TABLE (Parts are listed in order of installation)

| CHECK OFF | DESCRIPTION | PART # | QUANTITY | |
|-----------|---|---------------------------------|-------------|----------|
| | PUMP ASSY-OIL Kit 31340-28X8A includes: { | PUMP ASSY-OIL | 31340-28X0A | 1 |
| | | SEAL-O RING | 31526-28X0C | 1 (of 7) |
| | | RING-SNAP | 31506-1XF12 | 1 |
| | SEAL-O RING (O-ring between CVT case and side cover) | 31526-28X0A | 1 | |
| | PULLEY ASSY - CVT (Belt and pulley "sub-assembly") | 31214-28X7A | 1 | |
| | Loctite 5460 Sealant | 999MP-LT5460P | As needed | |
| | BOLT | 31377-1XD00 (or 31377-1XZ0B) | 19 (of 42) | |
| | SEAL-O RING (For pulley retainer bolts) | 31526-28X0C | 6 (of 7) | |
| | SEAL-OIL,DIFF (Differential side oil seal; CVT case side) | 38342-3VX0A | 1 | |
| | BRG ASSY-THRUST NEEDLE (Thrust bearing) | See page 96 | 1 | |
| | SEAL ASSY-OIL (Torque converter oil seal; converter housing) | 31375-1XF00 | 1 | |
| | SEAL-OIL,DIFF (Differential side oil seal; converter housing side, front wheel drive only) | 38342-3VX0B | 1 | |
| | SEAL-O RING (For input shaft) | 31526-80X01 | 1 | |
| | Loctite 5460 Sealant | 999MP-LT5460P | As needed | |
| | BOLT | 31377-1XD00 | 23 (of 42) | |
| | FLTR ASSY-OIL,AUTO TRANS (CVT fluid filter) | 31726-28X0A | 1 | |
| | SEAL-O RING (For filter cover) | 31526-3VX0A | 1 | |
| | SEAL-LIP (Between CVT and control valve) | 31528-1XZ0A | 1 | |
| | BRACKET (Temperature sensor bracket) | 31069-3VX0D | 1 | |
| | VALVE ASSY-CONT (Control valve) | 31705-28X0B | 1 | |
| | BAND (Zip tie for bracket) | 24224-3VX0A | 1 | |
| | STRAINER ASSY-OIL, AUTO TRANS | 31728-28X0A | 1 | |
| | GSKT-OIL PAN | 31397-1XF0D | 1 | |
| | WASHER-DRAIN (For drain plug) | 11026-JA00A | 1 | |
| | Seal O-Ring (Speed Sensor) | 31526-1XG0C | 1 | |
| | Transmission Cooler Cleaner | 999MP-AM006P | As needed | |
| | CLAMP (Hose Spring Clamp) | 16439-7S01E | 2 | |
| | SEAL-O RING (CVT filler plug at converter housing) | 31526-3VX0B | 1 | |
| | Nissan NS-3 CVT Fluid | 999MP-CV0NS3 | As needed | |
| | SEAL-O RING (Transfer case to CVT, AWD only) | 33118-4BA0A | 1 | |

THRUST BEARINGS

| DESCRIPTION | PART #: 31407- | BEARING THICKNESS | QTY |
|----------------|----------------|-------------------|---|
| THRUST BEARING | 1XZ0B | 3.57 | 1 of each is included in the Pulley Kit. Select 1 for installation. |
| | 1XZ0C | 3.75 | |
| | 1XZ0D | 3.93 | |
| | 1XZ0E | 4.1 | |
| | 1XZ1A | 4.28 | |
| | 1XZ1B | 4.46 | |
| | 1XZ1C | 4.61 | |
| | 1XZ1D | 4.79 | |

PART KITS VISUAL REFERENCE

- The following Figures show the smaller components of KIT-PULLEY.
- KIT- CONTROL VALVE is not shown.



Figure 183 shows the assorted seals, O-rings, etc. in "KIT-PULLEY"

Figure 183

PUMP ASSY-OIL parts



Figure 184

BRG ASSY-THRUST NEEDLE parts

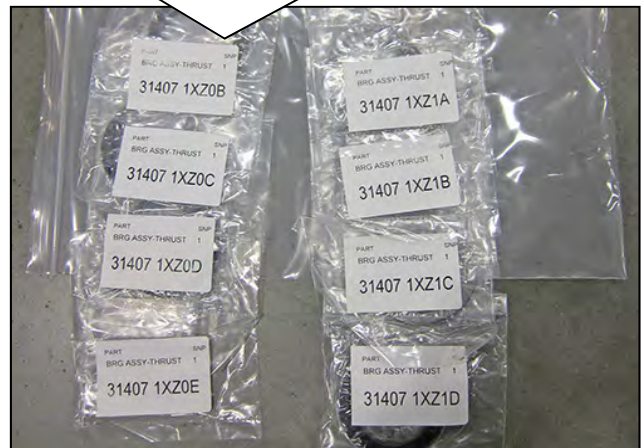

Figure 185

REMINDER! Attach the following to the repair order:

- Total EndPlay calculation (Page 59)
- Parts Kit Reference Table (Page 95)
- C-III plus screen showing the TCM part number before and after the reprogramming (Step 149 on page 85)
- C-III plus screen showing the current calibration data (Step 152 on page 86)
- C-III plus screen showing the new calibration data (Step 168 on page 87)

AMENDMENT HISTORY

| DATE | REFERENCE | DESCRIPTION |
|----------------|------------------|-----------------------------|
| August 1, 2019 | NTB19-060 | Original bulletin published |

