

- ATTENTION:**
- GENERAL MANAGER
  - PARTS MANAGER
  - CLAIMS PERSONNEL
  - SERVICE MANAGER

IMPORTANT - All Service Personnel Should Read and Initial in the boxes provided, right.

© 2019 Subaru of America, Inc. All rights reserved.



QUALITY DRIVEN® SERVICE

## SERVICE BULLETIN

**APPLICABILITY:** 2013-2019MY BRZ

**NUMBER:** 15-244-19

**SUBJECT:** A/C Compressor Clutch- Service Parts Availability

**DATE:** 07/22/19

### INTRODUCTION:

This bulletin announces availability of individual service parts and provides an installation procedure for the A/C compressor clutch assembly. Previously, a complete compressor assembly was necessary if any of the clutch components required replacement.

### PART INFORMATION:

Description	Part Number	Note
CLUTCH ASSY	73121CA000	
SNAP RING	73073KA000	Secures the stator (magnet, regular "outside" type)
	73073KA010	Secures the rotor (belt pulley, "wavy" type)
BOLT	73028KA120	Secures the hub (front plate)
SCREW	491585802	Secures the harness clamp
CLAMP	73182CA000	Secures the harness
FIXING TOOL SET	73193CA000	Hub to Rotor shim kit

**REMINDER:** Always order the most up-to-date replacement parts based on the specific VIN being repaired.

### Exploded View:

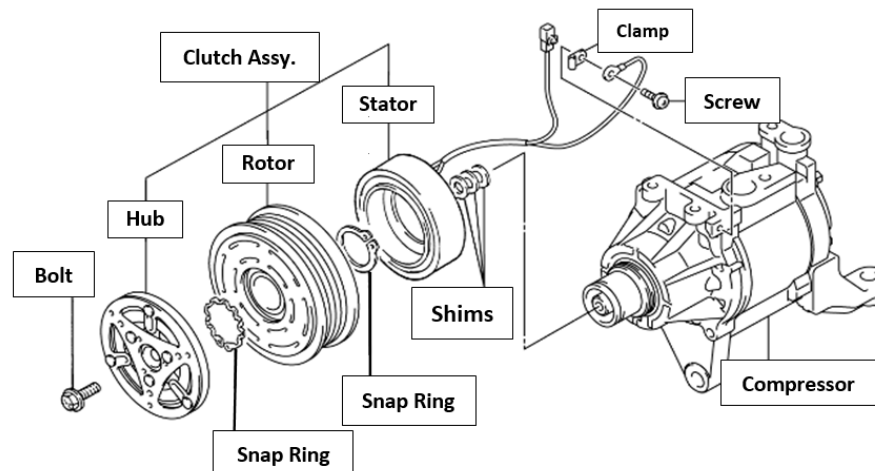

**CAUTION: VEHICLE SERVICING PERFORMED BY UNTRAINED PERSONS COULD RESULT IN SERIOUS INJURY TO THOSE PERSONS OR TO OTHERS.**

Subaru Service Bulletins are intended for use by professional technicians ONLY. They are written to inform those technicians of conditions that may occur in some vehicles, or to provide information that could assist in the proper servicing of the vehicle. Properly trained technicians have the equipment, tools, safety instructions, and know-how to do the job correctly and safely. If a condition is described, DO NOT assume that this Service Bulletin applies to your vehicle, or that your vehicle will have that condition.

**Subaru of America, Inc. is ISO 14001 Compliant**

ISO 14001 is the international standard for excellence in Environmental Management Systems. Please recycle or dispose of automotive products in a manner that is friendly to our environment and in accordance with all local, state and federal laws and regulations.

*Continued...*

## SERVICE PROCEDURE / INFORMATION:

**REMINDER:** Customer satisfaction and retention starts with performing quality repairs. The following Service procedure outlines replacement of the A/C Compressor clutch assembly. It is not currently provided in the Service Manual. It is **STRONGLY** recommended to review this procedure thoroughly before proceeding further.

### IMPORTANT PRECAUTIONS:

- Both snap rings are **1-time** use items.
- **CAUTION:** ALWAYS wear eye protection whenever working with snap rings.
- When installing the stator and rotor snap rings, they must be installed in the proper direction.
- When removing the hub, pay close attention to the shims which may be stuck to the hub and / or to the end of the compressor shaft splines. The number of shims can range from zero (0) to three (3). These shims are used to set the air gap between the hub and rotor during reassembly.

### DISASSEMBLY:

**Step 1)** Remove the drive belt cover, drive belt and drive belt cover bracket following the procedure in the applicable Service Manual.

**Step 2)** Using the Special tools 18355AA000 (Pulley Wrench) and 18334AA020 Pulley Wrench Pin Set, **CAREFULLY** hold the hub in place and loosen / remove the bolt from the center as shown below.

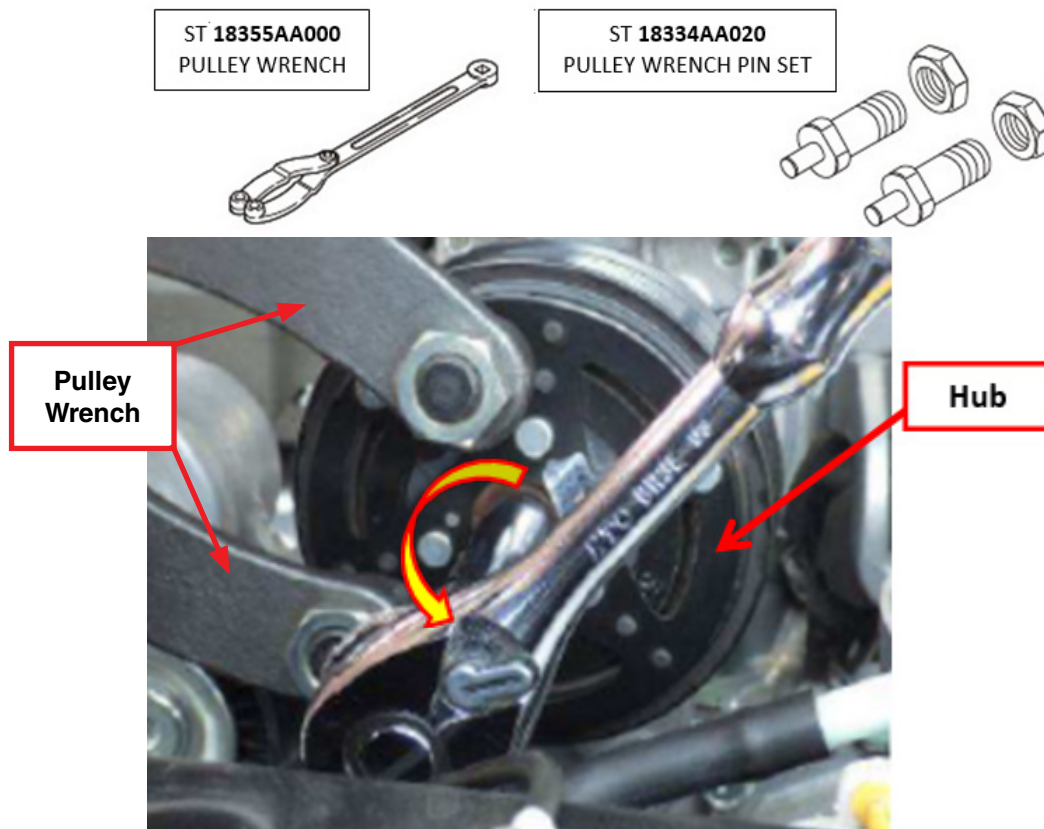

*Continued...*

**Step 3)** After removing the bolt, **CAREFULLY** remove the hub from the compressor shaft splines. Pay close attention to the shims (small, thin washers) which may either stick to the bottom of the hub splined portion or to the end of the compressor shaft as shown in the photos below. **IMPORTANT:** Note the number of shims used (0-3) as this will be the starting point to use at reassembly when setting the hub to rotor (pulley) air gap / clearance.

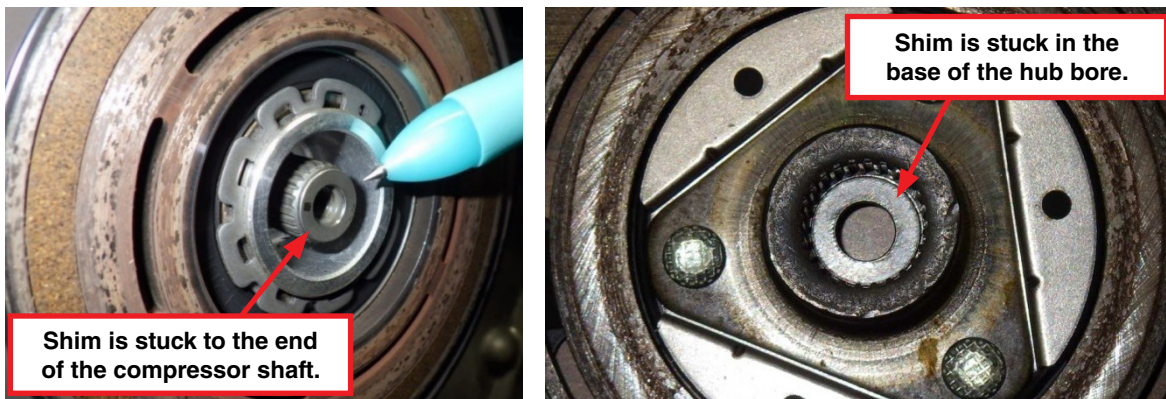

**Step 4)** Disconnect the clutch wire harness connector and remove the Philips screw securing the harness clamp to the compressor. Spread the clamp (only as much as needed) to remove it from the harness and transfer it to the new stator assembly harness **in the same position** using the image below as a guide. Do not reconnect the harness at this point.

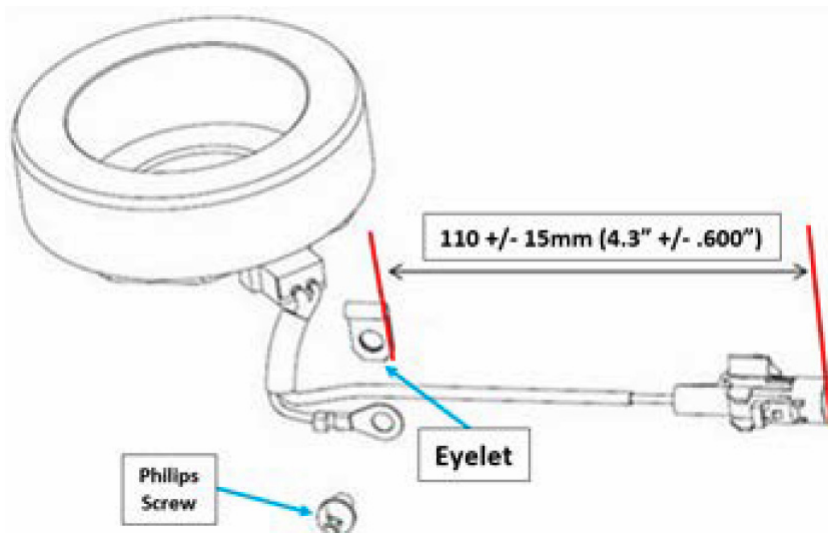
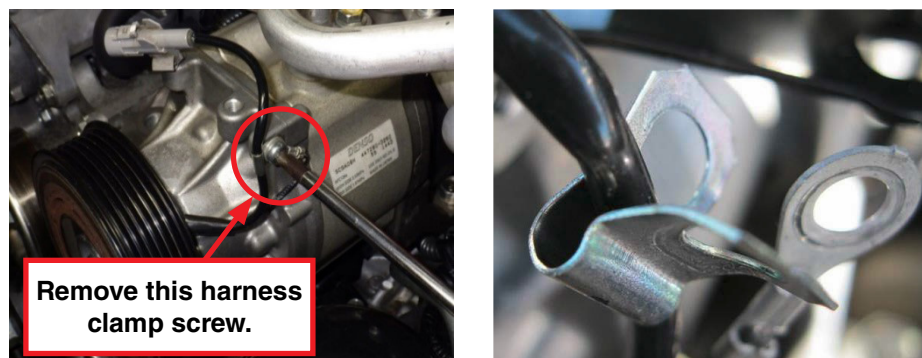

*Continued...*

**Step 5)** Using snap ring pliers, remove (and discard) the “wavy” snap ring securing the rotor (drive pulley). Slide it forward to remove it and expose the stator (magnet).

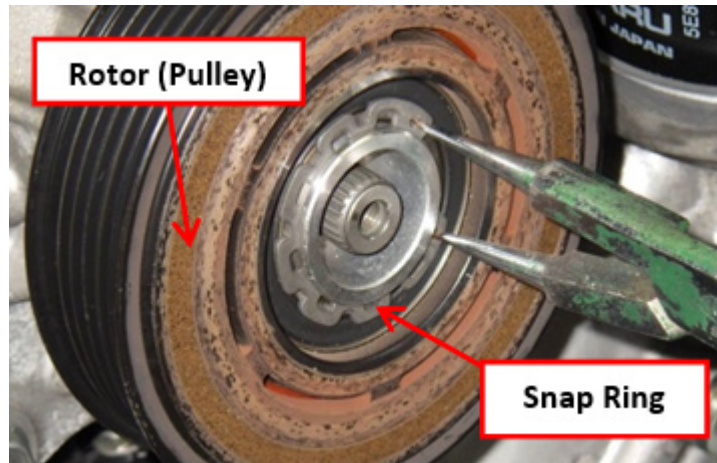

**Step 6)** Using snap ring pliers, remove (and discard) the flat “outside” snap ring securing the stator (magnet). Remove it to expose the positioning groove on the front face of the compressor housing.

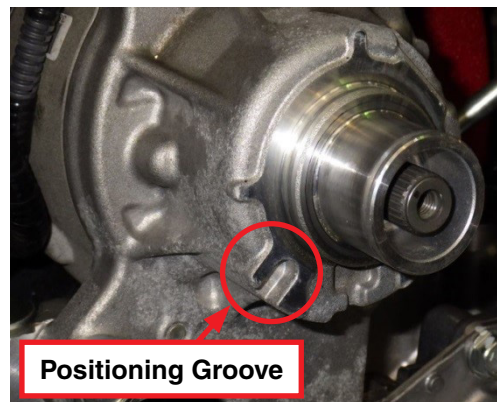
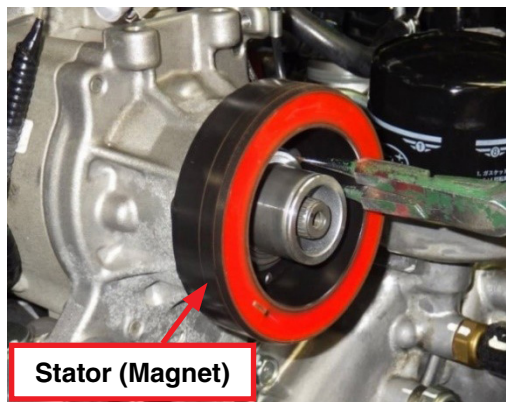

## REASSEMBLY:

**Step 7)** Fit the new stator assembly to the compressor. **VERY IMPORTANT:** The protrusion (locating pin) on the back of the stator face **MUST** fit into the positioning groove on the compressor as shown above.



*Continued...*

**Step 8)** Inspect both new snap rings and identify the “beveled” side of each as shown.

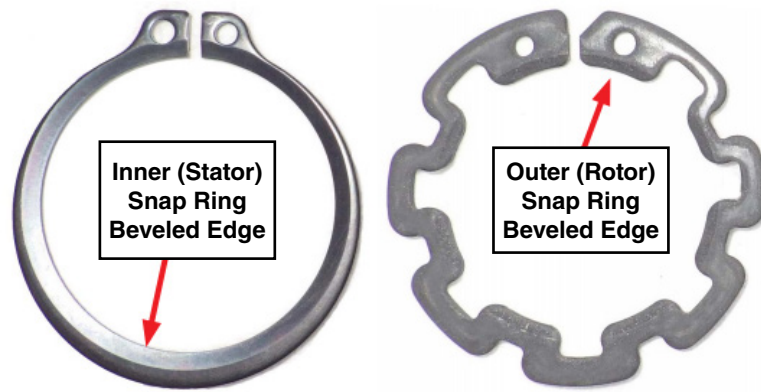

**Step 9)** Install the stator and its snap ring first then install the rotor (pulley) and its outer “wavy” snap ring. **IMPORTANT:** The beveled edge of both snap rings must **always face front** (forward) at reassembly. Always confirm each snap ring is fully seated in its receiving groove before proceeding.

**Step 10)** Insert the retaining bolt through the hub and install the same number of shims used on the original clutch onto the bolt. Install the hub onto the compressor shaft being careful to not lose any of the shims. Just **snug** (do not fully tighten or torque) the retaining bolt at this point. **REMINDER:** Due to manufacturing tolerances, the shim requirement may range from 0 to 3 to achieve the proper air gap (clearance).

**Step 11)** Using a feeler gauge, measure the air gap between the back face of the hub and front face of the rotor (pulley) as shown. The air gap specifications are:

- .35mm, +.15 / -.1mm (“OK” range is from .5mm to .25mm) or
- .014”, +.006” / -.004” (“OK” range is from .020” to .010”).



If the measurement is outside the specification, remove the hub as described in **Step 3**. Add (to INCREASE the air gap) or remove shim(s) (to DECREASE the air gap) as needed to achieve the necessary air gap. When the proper air gap is achieved, torque the retaining bolt to 9.75 ft. lbs. or 117 inch-lbs.

*Continued...*

**Step 12)** Reinstall the drive belt and any other removed components in reverse order. Always confirm proper system operation to complete the procedure.

**WARRANTY / CLAIM INFORMATION:**

For vehicles within the Basic New Car Limited Warranty period or covered by an active Subaru Added Security Classic or Gold plan, this repair may be submitted using the following claim information:

Labor Description	Labor Operation #	Labor Time	Fail Code
A/C COMPRESSOR CLUTCH R&R (Includes testing)	A014-141	0.9	DSK46

**IMPORTANT REMINDERS:**

- SOA strongly discourages the printing and/or local storage of service information as previously released information and electronic publications may be updated at any time.
- Always check for any open recalls or campaigns anytime a vehicle is in for servicing.
- Always refer to STIS for the latest service information before performing any repairs.