

# Recall Campaign

Daimler Trucks  
North America LLC

June 2019  
FL761A-C  
NHTSA #18V-157 (School Buses)  
#18V-158 (Non-School Buses)  
Transport Canada #18-119 (School Buses)  
#18-120 (Non-School Buses)

REVISED NOTICE

## Subject: TBB Minotour Wheelchair Lift Interlock

**Models Affected: Specific Thomas Built Buses Minotour buses equipped with an optional wheelchair lift manufactured June 22, 2007, through December 8, 2017.**

### General Information

Daimler Trucks North America LLC, on behalf of its wholly owned subsidiary, Thomas Built Buses, Inc., has decided that a defect which relates to motor vehicle safety exists on specific Thomas Built Buses Minotour buses equipped with an optional wheelchair lift manufactured June 22, 2007, through December 8, 2017.

On certain buses, the interlock may not prevent the wheelchair lift from operating while the vehicle gear shifter is in neutral or drive. If the vehicle is moved while the wheelchair lift is in operation, there is an increased risk of injury.

The wheelchair lift wiring will be inspected and repaired as needed.

**REVISIONS:** A procedure for FL761-C has been added and the work instructions and parts table have been updated.

### Additional Repairs

Dealers must complete all outstanding Recall and Field Service campaigns prior to the sale or delivery of a vehicle. A Dealer will be liable for any progressive damage that results from its failure to complete campaigns before sale or delivery of a vehicle.

Owners may be liable for any progressive damage that results from failure to complete campaigns within a reasonable time after receiving notification.

### Work Instructions

Please refer to the attached work instructions.

### Replacement Parts

Replacement parts are now available and can be obtained by ordering from your facing Parts Distribution Center.

**Table 1** – Replacement Parts for FL761

Campaign Number	Part Number	Description	Qty.
FL761A-C	TBB 175974	HARNES, LIFT INTERLOCK, 2012 GMC	1 ea
FL761B	TBB 217778	WIRING HARNES LIFT OPTION INTERF LIFT	1 ea

Table 1

# Recall Campaign

Daimler Trucks  
North America LLC

June 2019

FL761A-C

NHTSA #18V-157 (School Buses)

#18V-158 (Non-School Buses)

Transport Canada #18-119 (School Buses)

#18-120 (Non-School Buses)

REVISED NOTICE

## Removed Parts

Please follow Warranty Failed Parts Tracking shipping instructions for the disposition of all removed parts.

## Labor Allowance

Table 2 – Labor Allowance

Campaign Number	Procedure	Time Allowed (Hours)	SRT Code	Corrective Action
FL761A-C	Inspect/verify lift operation	0.2	996-R009A	06 – Inspect
FL761A-C	Inspect and replace harness under the dash	0.4	996-R009B	12 – Repair Recall/Campaign
FL761A,C	Inspect and modify harness at the electrical panel	0.5	996-R009C	12 – Repair Recall/Campaign
FL761B	Inspect, replace harness under the dash, and replace harness at electrical panel	0.7	996-R009D	12 – Repair Recall/Campaign

Table 2

## Claims for Credit

You will be reimbursed for your parts, labor, and handling by submitting your claim through the Warranty system within 30 days of completing this campaign. Please reference the following information in OWL:

- Claim Type is **Recall Campaign**.
- In the Campaign field, enter the campaign number (**FL761-A, FL761-B, or FL761-C**).
- In the Primary Failed Part field, enter **TBB 150043**.
- In the Parts section, enter the appropriate part number(s) as shown in the Replacement Parts Table.
- In the Labor section, enter the appropriate SRT from the Labor Allowance Table.
- The VMRS Component Code is **174-024-105** and the Cause Code is **A1 - Campaign**.
- **U.S. and Canada – Reimbursement for Prior Repairs**. When a customer asks about reimbursement, please do the following:
  - Accept the documentation of the previous repair.
  - Make a brief check of the customer's paperwork to see if the repair may be eligible for reimbursement.
  - Submit a Recall Pre-Approval request for a decision and authorized amount.
  - Submit a "based on" claim for the approved pre-approval.
  - Attach the documentation to the pre-approval request.
  - When your claim is paid, reimburse the customer the appropriate amount.

# Recall Campaign

**Daimler Trucks  
North America LLC**

June 2019

FL761A-C

NHTSA #18V-157 (School Buses)

#18V-158 (Non-School Buses)

Transport Canada #18-119 (School Buses)

#18-120 (Non-School Buses)

## REVISED NOTICE

**IMPORTANT:** OWL must be viewed prior to performing the recall to ensure the vehicle is involved and the campaign has not been previously completed. Also, check for a completion sticker prior to beginning work.

Contact the Warranty Campaigns Department at (336) 889-4871, from 8:00 a.m. to 5:00 p.m. Eastern Time, Monday through Friday, via Web inquiry at [AccessFreightliner.com](http://AccessFreightliner.com) / My Tickets and Submit an Inquiry, if you have any questions or need additional information.

To return excess kit inventory related to this campaign, U.S. dealers must submit a Parts Authorization Return (PAR) to the Memphis PDC. Canadian dealers must submit a PAR to their facing PDC. All kits must be in resalable condition. PAR requests must include the original purchase invoice number.

The letter notifying U.S. and Canadian vehicle owners is included for your reference.

Please note that the National Traffic and Motor Vehicle Safety Act, as amended (Title 49, United States Code, Chapter 301), requires the owner's vehicle(s) be corrected within a reasonable time after parts are available to you. The Act states that failure to repair a vehicle within 60 days after tender for repair shall be prima facie evidence of an unreasonable time. However, circumstances of a particular situation may reduce the 60-day period. Failure to repair a vehicle within a reasonable time can result in either the obligation to (a) replace the vehicle with an identical or reasonably equivalent vehicle, without charge, or (b) refund the purchase price in full, less a reasonable allowance for depreciation. The Act further prohibits dealers from selling a vehicle unless all outstanding recalls are performed. Any lessor is required to send a copy of the recall notification to the lessee within 10 days. Any subsequent stage manufacturer is required to forward this notice to its distributors and retail outlets within five working days.

# Recall Campaign

Daimler Trucks  
North America LLC

June 2019

FL761A-C

NHTSA #18V-157 (School Buses)

#18V-158 (Non-School Buses)

Transport Canada #18-119 (School Buses)

#18-120 (Non-School Buses)

REVISED NOTICE

## Copy of Notice to Owners

### Subject: TBB Minotour Wheelchair Lift Interlock

This notice is sent to you in accordance with the requirements of the National Traffic and Motor Vehicle Safety Act. This notice is sent to you in accordance with the Canadian Motor Vehicle Safety Act.

Daimler Trucks North America LLC, on behalf of its wholly owned subsidiary, Thomas Built Buses, Inc., has decided that a defect which relates to motor vehicle safety exists on specific Thomas Built Buses Minotour buses equipped with an optional wheelchair lift manufactured June 22, 2007, through December 8, 2017.

On certain buses, the interlock may not prevent the wheelchair lift from operating while the vehicle gear shifter is in neutral or drive. If the vehicle is moved while the wheelchair lift is in operation, there is an increased risk of injury.

The wheelchair lift wiring will be inspected and repaired as needed. This is the second notice regarding this recall and is to inform you the remedy is now available. **To arrange for repairs, you should contact your local Thomas Built Buses dealer immediately.** The repair should take up to approximately 45 minutes and will be performed at no charge to you.

You may be liable for any progressive damage that results from your failure to complete the Recall within a reasonable time after receiving notification.

If you do not own the vehicle that corresponds to the identification number(s) which appears on the Recall Notification, please return the notification to the Warranty Department with any information you can furnish that will assist us in locating the present owner. If you have leased this vehicle, Federal law requires that you forward this notice to the lessee within 10 days.

If you have paid to have this recall condition corrected prior to this notice, you may be eligible to receive reimbursement. For further information, please contact the Warranty Department at (336) 889-4871, 8 a.m. to 5 p.m. Eastern Time, Monday through Friday. To find a dealer in your area please go to [www.thomasbus.com](http://www.thomasbus.com).

If you have any questions about this recall, please contact the Warranty Department at (336) 889-4871, 8:00 a.m. to 5:00 p.m. Eastern Time, Monday through Friday. If you are not able to have the defect remedied without charge and within a reasonable time, you may wish to submit a complaint to the Administrator, National Highway Traffic Safety Administration, 1200 New Jersey Avenue, SE, Washington, DC 20590; or call the Vehicle Safety Hotline at (888) 327-4236 (TTY: 800-424-9153); or to <http://www.safercar.gov>. In Canada, you may contact Transport Canada-road safety, 80 rue Noel, Gatineau, Quebec J8Z 0A1 or call 1-800-333-0510.

We regret any inconvenience this action may cause but feel certain you understand our interest in motor vehicle safety.

THOMAS BUILT BUSES WARRANTY DEPARTMENT

Enclosure

# Recall Campaign

Daimler Trucks  
North America LLC

June 2019

FL761A-C

NHTSA #18V-157 (School Buses)

#18V-158 (Non-School Buses)

Transport Canada #18-119 (School Buses)

#18-120 (Non-School Buses)

REVISED NOTICE

## Work Instructions

### Subject: TBB Minotour Wheelchair Lift Interlock

**Models Affected: Specific Thomas Built Buses Minotour buses equipped with an optional wheelchair lift manufactured June 22, 2007, through December 8, 2017.**

**FL761A and FL761C – Begin with *FL761A and FL761C – Wheelchair Lift Interlock Inspection (Standard Operation)* below on this page**

**FL761B – Begin with *FL761B – Wheelchair Lift Interlock Inspection (Option B3800-20-000)* starting on page 11**

### **FL761A & FL761C – Wheelchair Lift Interlock Inspection (Standard Operation)**

1. Park the vehicle, shut down the engine, make sure the shifter is in Park/Neutral, set the parking brake, and chock the tires.
2. Before beginning work, check and note the body start date for the bus in OWL.
  - 2.1 Buses with a body start date from February 25, 2018, through March 31, 2010, require an additional procedure. Perform *FL761A & FL761C – Harness Repair (Standard Operation – Built February 25, 2008, through May 31, 2010)* when instructed.
  - 2.2 Buses with a body start date outside the date range noted in 2.1 above, do *not* require the additional procedure.
3. Test lift operation in “Park.”
  - 3.1 Start the bus.
  - 3.2 Turn on the lift switch and push down on the parking brake.
  - 3.3 Open the lift door completely. The lift should beep three times to indicate it is active and the controller should light up.
  - 3.4 With the lift door open, press down on the service brake and attempt to take the bus out of “Park.”

If the bus can be taken out of “Park,” repair is needed. Go to *FL761A & FL761C – Harness Installation (Standard Operation)*.

If the bus cannot be taken out of “Park,” continue with the next step.

# Recall Campaign

Daimler Trucks  
North America LLC

June 2019

FL761A-C

NHTSA #18V-157 (School Buses)

#18V-158 (Non-School Buses)

Transport Canada #18-119 (School Buses)

#18-120 (Non-School Buses)

## REVISED NOTICE

NOTE: A second person is needed for step 4.

4. Test lift operation in "Neutral."
  - 4.1 Start the bus, if necessary.
  - 4.2 Confirm the parking brake is set.
  - 4.3 With a second person in the driver's seat, press the brake pedal to release the gear lever.
  - 4.4 Place the bus in "Neutral," on the switch panel above the driver, turn the lift switch to "On."
  - 4.5 With a second person remaining in the driver's seat, from outside the bus, open the lift door completely. If the lift is active, it should beep three times and the controller should light up.
5. Attempt to deploy the lift.

If the lift works while in neutral with the parking brake set and the lift door completely open, repair is needed. Go to *FL761A & FL761C – Harness Installation (Standard Operation)*.

If the lift does not operate, no further work is needed. Park the vehicle.

## FL761A & FL761C – Under Dash Harness Installation (Standard Operation)

1. If necessary, park the vehicle, shut down the engine, place in park, set the parking brake, and chock the tires.
2. Remove the panel just below steering column. Using a 10 mm socket, remove the two screws underneath the panel. See **Figure 1**.



**Figure 1: Location of Screws Beneath the Steering Column Panel**

3. Cut the two brown wires between the connectors shown in **Figure 2 Items A and B** as close to the butt splice as possible (to allow connection to the new harness).

# Recall Campaign

Daimler Trucks  
North America LLC

June 2019

FL761A-C

NHTSA #18V-157 (School Buses)

#18V-158 (Non-School Buses)

Transport Canada #18-119 (School Buses)

#18-120 (Non-School Buses)

## REVISED NOTICE

4. Install new harness TBB 175974 as shown in **Figures 2 and 3**.
  - 4.1 Connect the new harness to Positions A and B, where the brown wires were cut.
  - 4.2 Connect the existing green wire to Position C on the new harness.
  - 4.3 Connect the existing green/white wire to Position D on the new harness.

5. Repeat the inspection procedure.

If the new installation passes the inspection, tie the wiring securely under the dash and reinstall the panel with the screws removed earlier.

If the new installation fails the inspection, review the wiring and new harness installation and correct any connections.

6. When the installation is correct, remove the chocks from the tires.

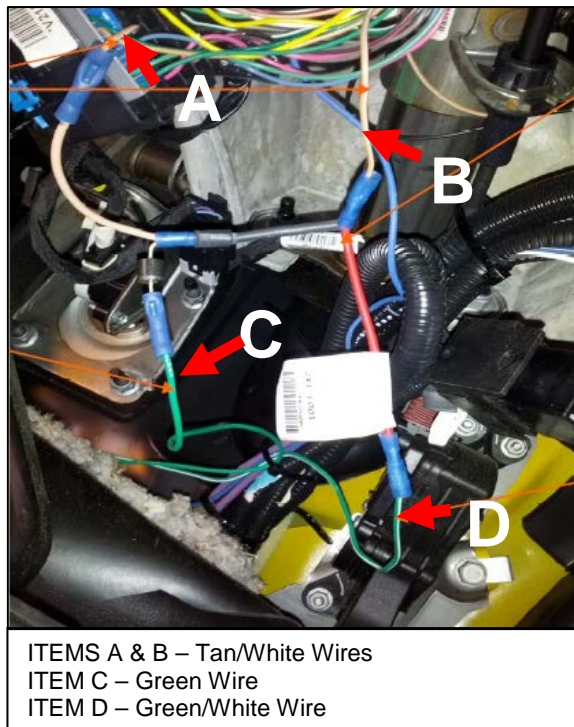

**Figure 2: Current Harness Installation**

# Recall Campaign

Daimler Trucks  
North America LLC

June 2019

FL761A-C

NHTSA #18V-157 (School Buses)

#18V-158 (Non-School Buses)

Transport Canada #18-119 (School Buses)

#18-120 (Non-School Buses)

REVISED NOTICE

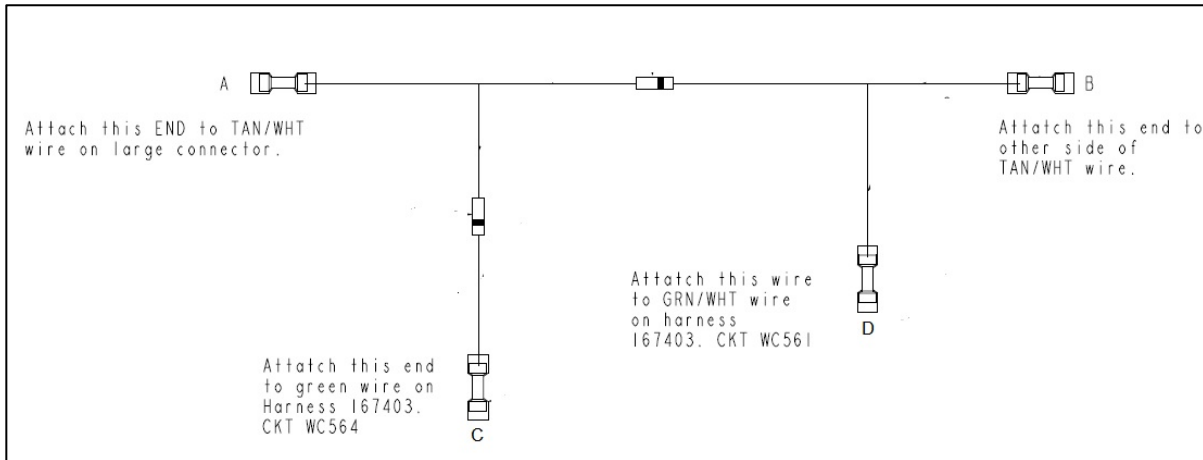

Figure 3: New Harness TBB 175974

7. For buses with a body start date from February 25, 2008, through March 31, 2010, continue with the next procedure. For buses *not* in this date range, remove the chocks from the tires

## FL761A & FL761C – Harness Repair (Standard Operation – Built February 25, 2008, through May 31, 2010)

1. Behind the PC board, cut wire WC564 about 3-4 inches back from plug (plug with 3 wires) and cap off the side going to plug. See **Figure 4**.
2. From the end cut from the plug, add approximately 12 inches of green wire. See **Figure 4**.



Figure 4: Plugs Behind the PC Boards

# Recall Campaign

Daimler Trucks  
North America LLC

June 2019

FL761A-C

NHTSA #18V-157 (School Buses)

#18V-158 (Non-School Buses)

Transport Canada #18-119 (School Buses)

#18-120 (Non-School Buses)

REVISED NOTICE

3. On relay 1 on the lift harness (on the metal mounting plate of the PC board), remove the ignition wire from position 5, which is 87 on the relay. See **Figure 5** for position and conversion of the relay block.
4. Put a spade terminal on the green wire that was added and plug it into position 5.

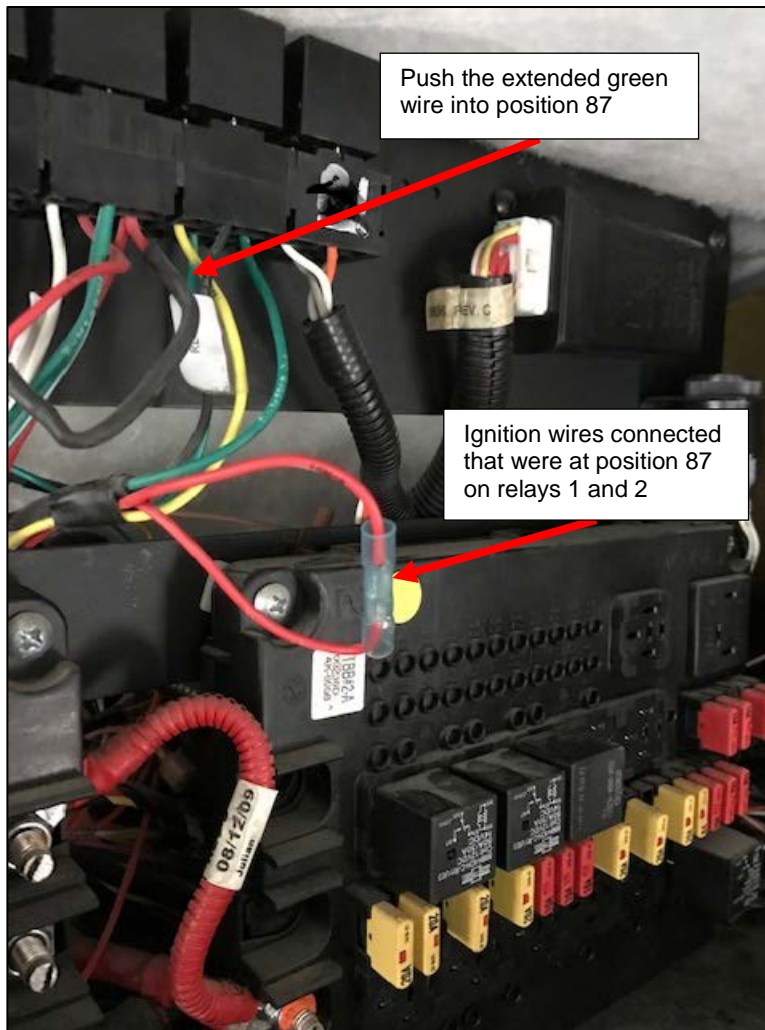

Figure 5: Connections at Relay

# Recall Campaign

Daimler Trucks  
North America LLC

June 2019

FL761A-C

NHTSA#18V-157 (School Buses)

#18V-158 (Non-School Buses)

Transport Canada #18-119 (School Buses)

#18-120 (Non-School Buses)

REVISED NOTICE

5. Connect the ignition wire that was in position 5 to the wire that was also in the same position 5 on the relay with a butt connector. See **Figure 6** and **Figure 7** for a schematics/diagrams showing the connections.

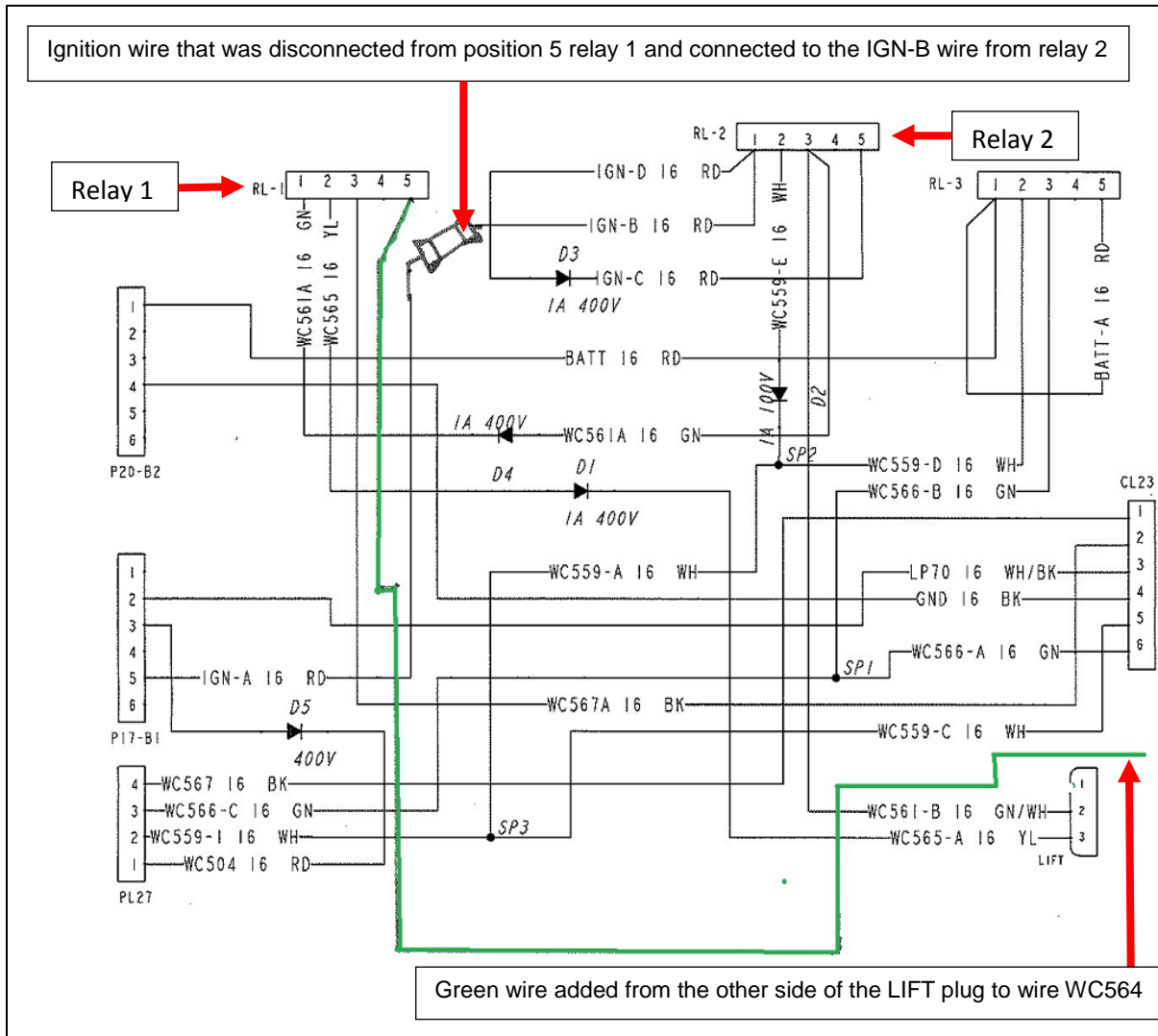

Figure 6: Schematic of Harness and Relays

# Recall Campaign

Daimler Trucks  
North America LLC

June 2019

FL761A-C

NHTSA #18V-157 (School Buses)

#18V-158 (Non-School Buses)

Transport Canada #18-119 (School Buses)

#18-120 (Non-School Buses)

REVISED NOTICE

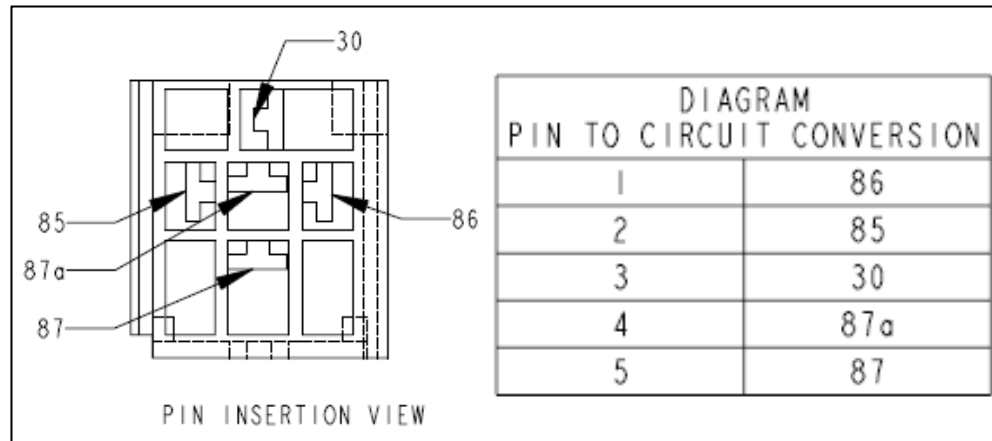

Figure 7: Pin Insertion and Conversion for Relay

## FL761B – Wheelchair Lift Interlock Inspection (Option B3800-20-000)

1. Park the vehicle, shut down the engine, make sure the shifter is in Park, chock the tires.
2. Test lift operation in “Park.”
  - 2.1 Start the bus.
  - 2.2 Push down on the parking brake then turn on the lift switch.
  - 2.3 Open the lift door completely. The lift should beep three time to indicate it is active and the controller should light up.
  - 2.4 With the lift door open, press down on the service brake and attempt to take the bus out of “Park.”

If the bus can be taken out of “Park,” repair is needed. Go to step 3 in procedure *FL761A & FL761C – Under Dash Harness Installation (Standard Operation)* above. When completed, return to step 3 below.

If the bus cannot be taken out of “Park,” close and lock the lift door and turn the lift switch to off. Continue with step 3.

NOTE: A second person is needed for step 3.

3. Test lift operation in “Neutral” with the key in the on position.
  - 3.1 Key in the on position, if necessary.
  - 3.2 Confirm the parking brake is set.
  - 3.3 With a second person in the driver’s seat, press the brake pedal to release the gear lever.
  - 3.4 Place the bus in “Neutral” while applying the service brake.
  - 3.5 On the switch panel above the driver, turn the lift switch to “On.”
  - 3.6 With a second person remaining in the driver’s seat, from outside the bus, open the lift door completely. If the lift is active, it should beep three times and the controller should light up.

# Recall Campaign

Daimler Trucks  
North America LLC

June 2019

FL761A-C

NHTSA #18V-157 (School Buses)

#18V-158 (Non-School Buses)

Transport Canada #18-119 (School Buses)

#18-120 (Non-School Buses)

REVISED NOTICE

3.7 Attempt to deploy the lift.

If the lift works while in neutral with the parking brake set and the lift door completely open, repair is needed. Go to *FL761B – Harness Installation (Option B3800-20-000)*.

If the lift does not operate, no further work is needed. Park the vehicle.

4. Test lift operation with the key off.

4.1 If needed, park the vehicle, shut down the engine, make sure the shifter is in Park, chock the tires.

4.2 With the bus in Park and the lift door open, attempt to shift the bus out of Park.

If the lift operates and the bus will not come out of Park, no further work is needed. Remove the chocks from the tires.

If the lift will not operate and/or the bus will shift out of Park, repair is needed. Go to *FL761B – Harness Installation (Option B3800-20-000)* below.

## FL761B – Harness Installation (Option B3800-20-000)

1. If necessary, park the vehicle, shut down the engine, place in park, set the parking brake, and chock the tires.
2. Remove the panel just below steering column. Using a 10 mm socket, remove the two screws underneath the panel. See **Figure 1**.
3. Compare the connections to **Figure 2**.

If the connections are the same, continue with the next step.

If the connections are different, install TBB 175974 (HARNESSES, LIFT INTERLOCK, 2012 GMC) and go to *FL761A & FL761C – Wheelchair Lift Interlock Inspection (Standard Operation)* and perform the inspection and repair.
4. Open the PC circuit board cabinet (above the driver's seat) and prop the door open. See **Figure 8**.
5. Remove the three screws indicated in **Figure 8** and lay the PC board down.
6. Remove the side cushion, retain it and screws. See **Figures 9 and 10**.
7. Remove the existing harness and install the new harness TBB 217778. The old and new harnesses have the same connection points on the back of the boards and connecting harnesses. **Figure 11** shows the locations on the back of the PC board. The remaining plugs on the harness will be connected to harnesses that are not plugged into the PC boards.
8. Remove each plug on existing harness TBB 150043 from the PC Boards one at a time and replace with the corresponding plug from the new harness TBB 217778. Once the PC board plugs are swapped, do the same with the remaining connections to harnesses as labeled.
9. Remove the relays from harness TBB 150043 on the PC board mounting panel and pull them through the slot toward the harness, then pull the existing harness out.
10. Once all plugs have been swapped, feed the 5 relays from the harness TBB 217778 through opening in the PC board mounting panel.
11. Mount relays to the panel, then install relays.

# Recall Campaign

Daimler Trucks  
North America LLC

June 2019

FL761A-C

NHTSA #18V-157 (School Buses)

#18V-158 (Non-School Buses)

Transport Canada #18-119 (School Buses)

#18-120 (Non-School Buses)

REVISED NOTICE

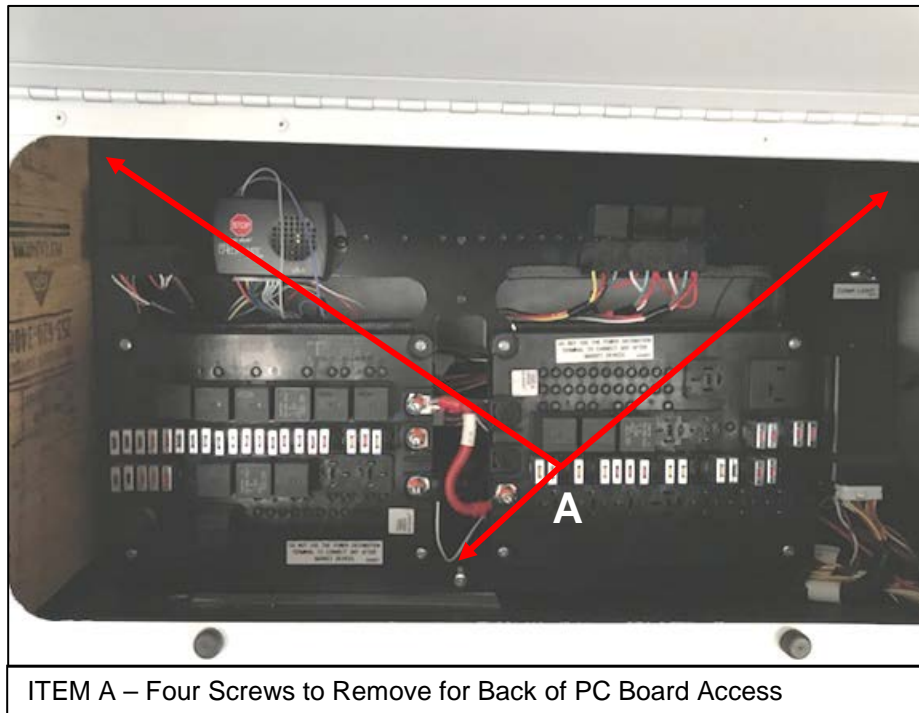

Figure 8: View of PC Boards



# Recall Campaign

Daimler Trucks  
North America LLC

June 2019

FL761A-C

NHTSA #18V-157 (School Buses)

#18V-158 (Non-School Buses)

Transport Canada #18-119 (School Buses)

#18-120 (Non-School Buses)

REVISED NOTICE

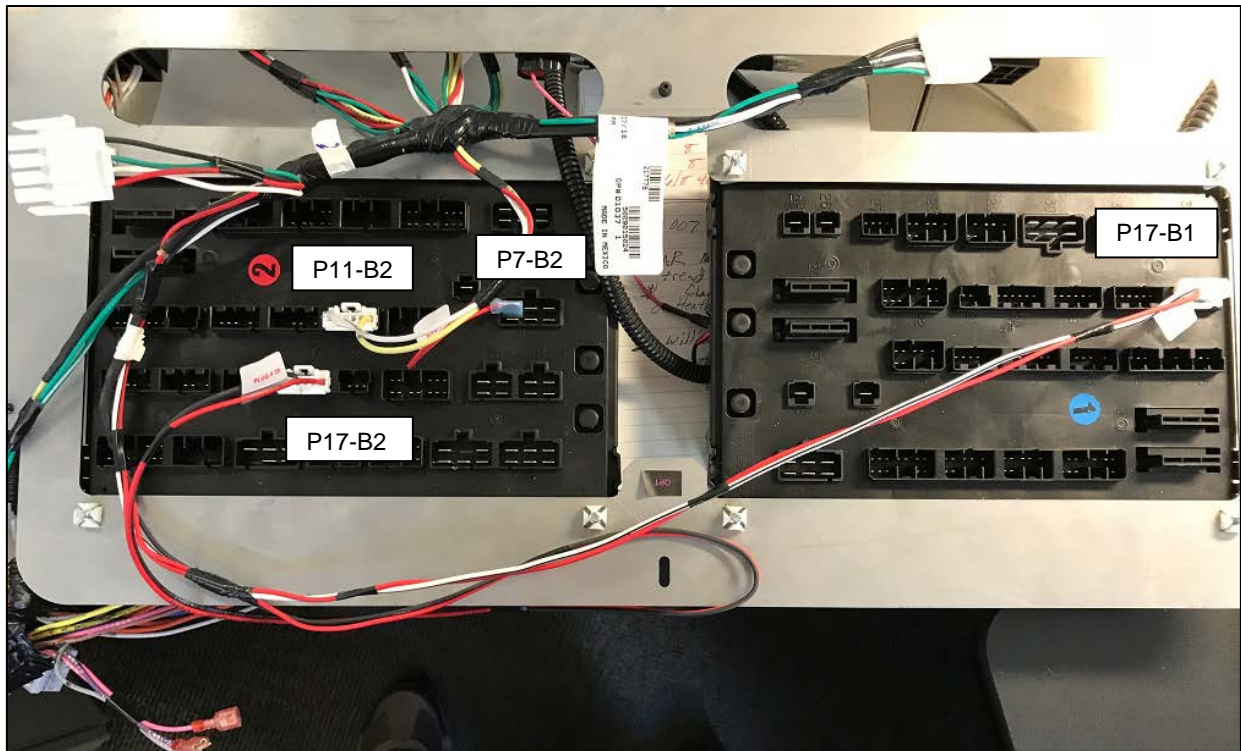

Figure 11: Rear of PC Boards Showing Connections, Only

15. Verify the system works correctly by repeating the earlier inspection procedures in these work instructions. If it does not, verify the installation and make any changes needed.
16. Secure any loose wires. Verify there are no wires that could rub or contact a rough/sharp surface.
17. Reinstall the side cushion with the screws removed earlier.
18. Remount the PC board mounting panel.
19. Remove chocks from the tires.