

Service Alert

Mazda North American Operations
Irvine, CA 92618-2922



Subject: 2019 MAZDA3 SERVICE CAUTIONS FOR NEW AND REVISED FEATURES	Service Alert No.: SA-010/19
	Last Issued: 05/02/2019

BULLETIN NOTES

This Service Alert supersedes the previously issued Service Alert(s) listed below: The changes are noted in Red.

Previous Service Alert(s):	Date(s) Issued:
SA-010/19	04/25/19, 04/11/19, 03/29/19, 03/21/19, 03/15/19, 03/08/19, 03/06/19, 03/05/19, 02/25/19

APPLICABLE MODEL(S)/VINS

2019 Mazda3

DESCRIPTION

The new 2019 Mazda3 has new and revised features that are different from previous models, and may be difficult to understand. This Service Alert provides valuable information to support potential dealer and customer concerns.

Item	Service Information
------	---------------------

CONSUMER NOTICE: The information and instructions in this bulletin are intended for use by skilled technicians. Mazda technicians utilize the proper tools/equipment and take training to correctly and safely maintain Mazda vehicles. These instructions should not be performed by "do-it-yourselfers." Customers should not assume this bulletin applies to their vehicle or that their vehicle will develop the described concern. To determine if the information applies, customers should contact their nearest authorized Mazda dealership. Mazda North American Operations reserves the right to alter the specifications and contents of this bulletin without obligation or advance notice. All rights reserved. No part of this bulletin may be reproduced in any form or by any means, electronic or mechanical---including photocopying and recording and the use of any kind of information storage and retrieval system ---without permission in writing.

Fuse to be Installed at PDI (JM1 = Japan built)

1. There is only one fuse removed at the factory that should be installed at PDI. It is fuse F27 (25A). The fuse is stored in the lid of the fuse box with the spare fuses.
2. The current PDI form is wrong. It states there are two (2) fuses removed (F46 and F50) that should be installed. The form is being updated with this change.

Fuse Block
(Engine Compartment)

CONSUMER NOTICE: The information and instructions in this bulletin are intended for use by skilled technicians. Mazda technicians utilize the proper tools/equipment and take training to correctly and safely maintain Mazda vehicles. These instructions should not be performed by "do-it-yourselfers." Customers should not assume this bulletin applies to their vehicle or that their vehicle will develop the described concern. To determine if the information applies, customers should contact their nearest authorized Mazda dealership. Mazda North American Operations reserves the right to alter the specifications and contents of this bulletin without obligation or advance notice. All rights reserved. No part of this bulletin may be reproduced in any form or by any means, electronic or mechanical---including photocopying and recording and the use of any kind of information storage and retrieval system ---without permission in writing.

Fuse to be Installed at PDI (3MZ = Mexico built)

1. There are two fuses removed at the factory that should be installed at PDI. They are fuse F27 (25A) and F15 (15A).
2. **NOTE: On some vehicles, fuse F13 (15A) is being removed instead of F15 at the factory. This causes the Commander switch to be inoperative.**
3. The F27 (25A) fuse is stored in the lid of the fuse box with the spare fuses.
4. The F15 (15A) fuse is stored in the lower panel compartment on the left side of the steering wheel.
5. Go to SA-017/19 for details.

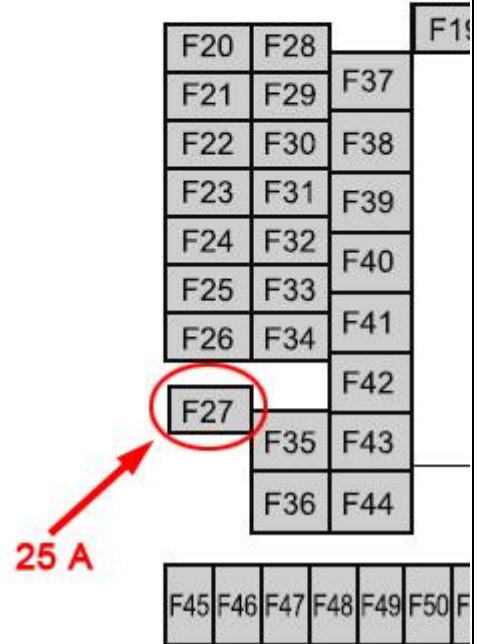

Fuse Block
(Left Side)

CONSUMER NOTICE: The information and instructions in this bulletin are intended for use by skilled technicians. Mazda technicians utilize the proper tools/equipment and take training to correctly and safely maintain Mazda vehicles. These instructions should not be performed by "do-it-yourselfers." Customers should not assume this bulletin applies to their vehicle or that their vehicle will develop the described concern. To determine if the information applies, customers should contact their nearest authorized Mazda dealership. Mazda North American Operations reserves the right to alter the specifications and contents of this bulletin without obligation or advance notice. All rights reserved. No part of this bulletin may be reproduced in any form or by any means, electronic or mechanical---including photocopying and recording and the use of any kind of information storage and retrieval system ---without permission in writing.

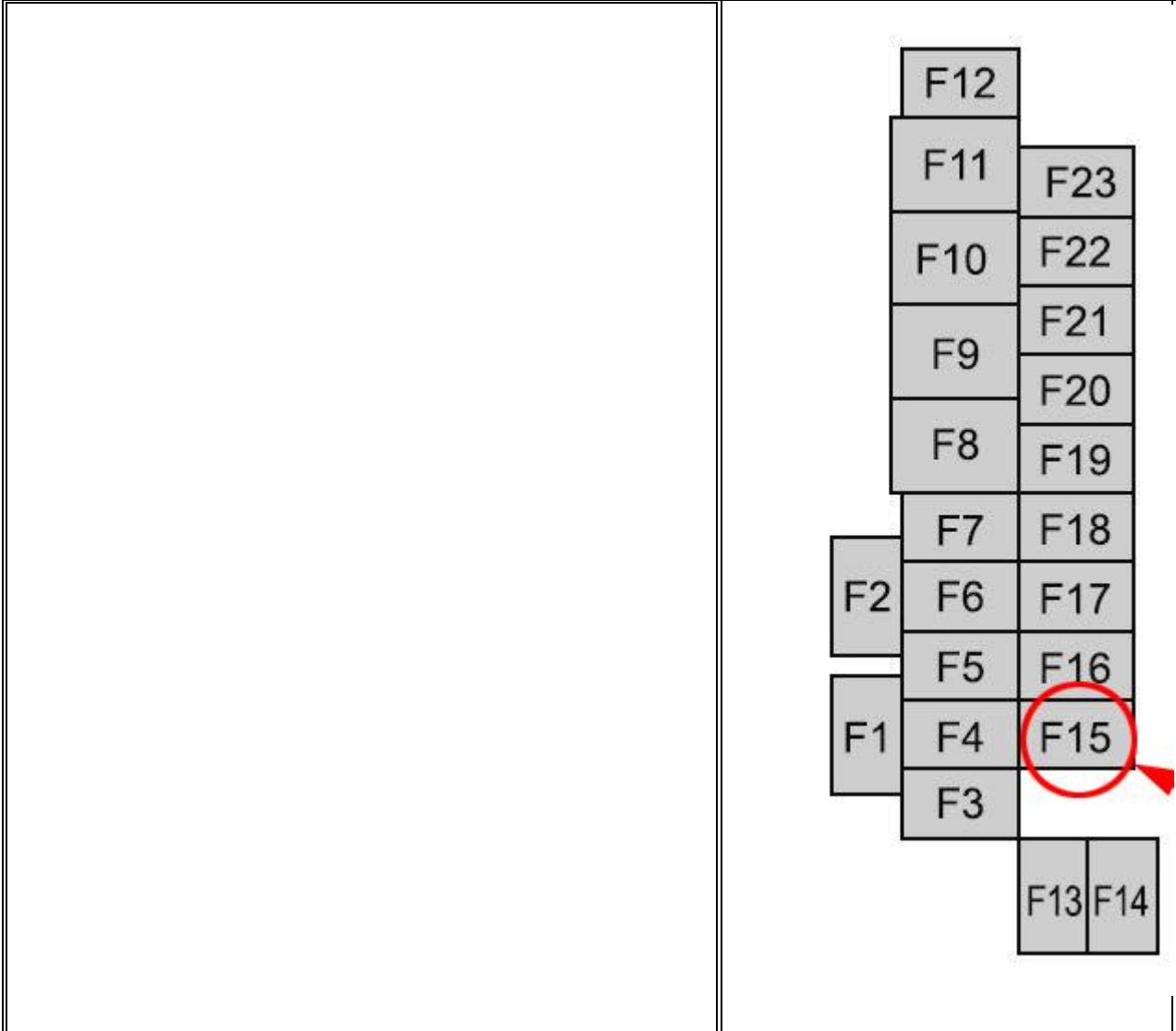

Front Wiper Service Caution

1. Wiper arm park position is located under the hood.
2. When servicing front wipers, front wiper service mode is required or damage to wiper arms may occur (see Service Information).
3. If wiper arms are replaced, M-MDS is needed for wiper arm adjustment (see Service Information)
4. DO NOT use wiper arms as markers when in dealer inventory.

See Owner's Manual -> Maintenance and Care > Replacing Windshield Wiper Blades

MGSS: WINDSHIELD WIPER ARM AND BLADE ADJUSTMENT

CONSUMER NOTICE: The information and instructions in this bulletin are intended for use by skilled technicians. Mazda technicians utilize the proper tools/equipment and take training to correctly and safely maintain Mazda vehicles. These instructions should not be performed by "do-it-yourselfers." Customers should not assume this bulletin applies to their vehicle or that their vehicle will develop the described concern. To determine if the information applies, customers should contact their nearest authorized Mazda dealership. Mazda North American Operations reserves the right to alter the specifications and contents of this bulletin without obligation or advance notice. All rights reserved. No part of this bulletin may be reproduced in any form or by any means, electronic or mechanical---including photocopying and recording and the use of any kind of information storage and retrieval system ---without permission in writing.

i-ACTIVSENSE Switch (New)



Activated Status: Green

When i-ACTIVSENSE is in normal operating status, the instrument cluster i-ACTIVSENSE indicator is green.

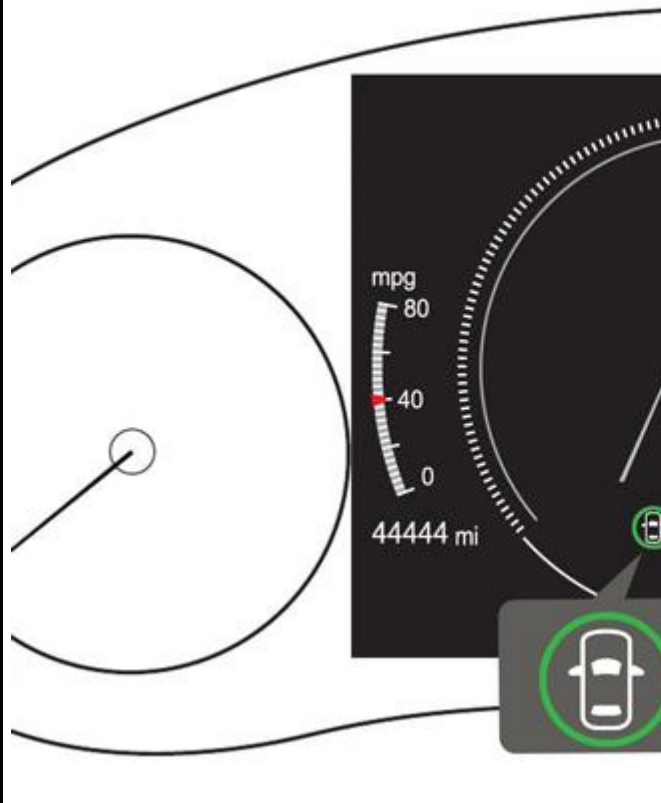

See Owner's Manual -> When Driving -> i-ACTIVSENSE -> i-ACTIVSENSE

CONSUMER NOTICE: The information and instructions in this bulletin are intended for use by skilled technicians. Mazda technicians utilize the proper tools/equipment and take training to correctly and safely maintain Mazda vehicles. These instructions should not be performed by "do-it-yourselfers." Customers should not assume this bulletin applies to their vehicle or that their vehicle will develop the described concern. To determine if the information applies, customers should contact their nearest authorized Mazda dealership. Mazda North American Operations reserves the right to alter the specifications and contents of this bulletin without obligation or advance notice. All rights reserved. No part of this bulletin may be reproduced in any form or by any means, electronic or mechanical---including photocopying and recording and the use of any kind of information storage and retrieval system ---without permission in writing.

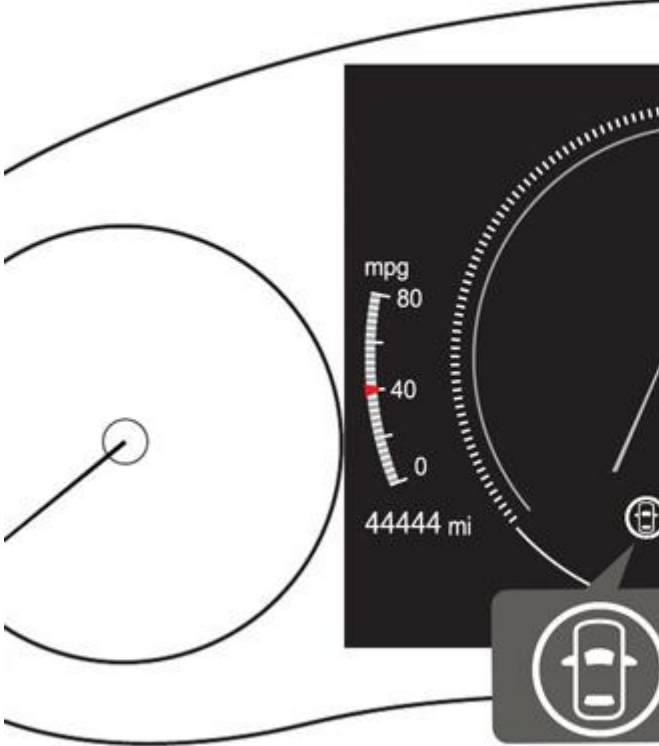
<p>When i- ACTIV SENSE has an enviro nment al fault, such as a dirty winds hield or driving into the sun, the instru ment cluster i- ACTIV SENSE indicat or is white.</p>	<p>Stand-by Status: White</p> 	
<p>When i- ACTIV SENSE has a fault that needs diagno sis by a dealer ship, the</p>	<p>Warning Status: Amber</p>	

CONSUMER NOTICE: The information and instructions in this bulletin are intended for use by skilled technicians. Mazda technicians utilize the proper tools/equipment and take training to correctly and safely maintain Mazda vehicles. These instructions should not be performed by "do-it-yourselfers." Customers should not assume this bulletin applies to their vehicle or that their vehicle will develop the described concern. To determine if the information applies, customers should contact their nearest authorized Mazda dealership. Mazda North American Operations reserves the right to alter the specifications and contents of this bulletin without obligation or advance notice. All rights reserved. No part of this bulletin may be reproduced in any form or by any means, electronic or mechanical---including photocopying and recording and the use of any kind of information storage and retrieval system ---without permission in writing.

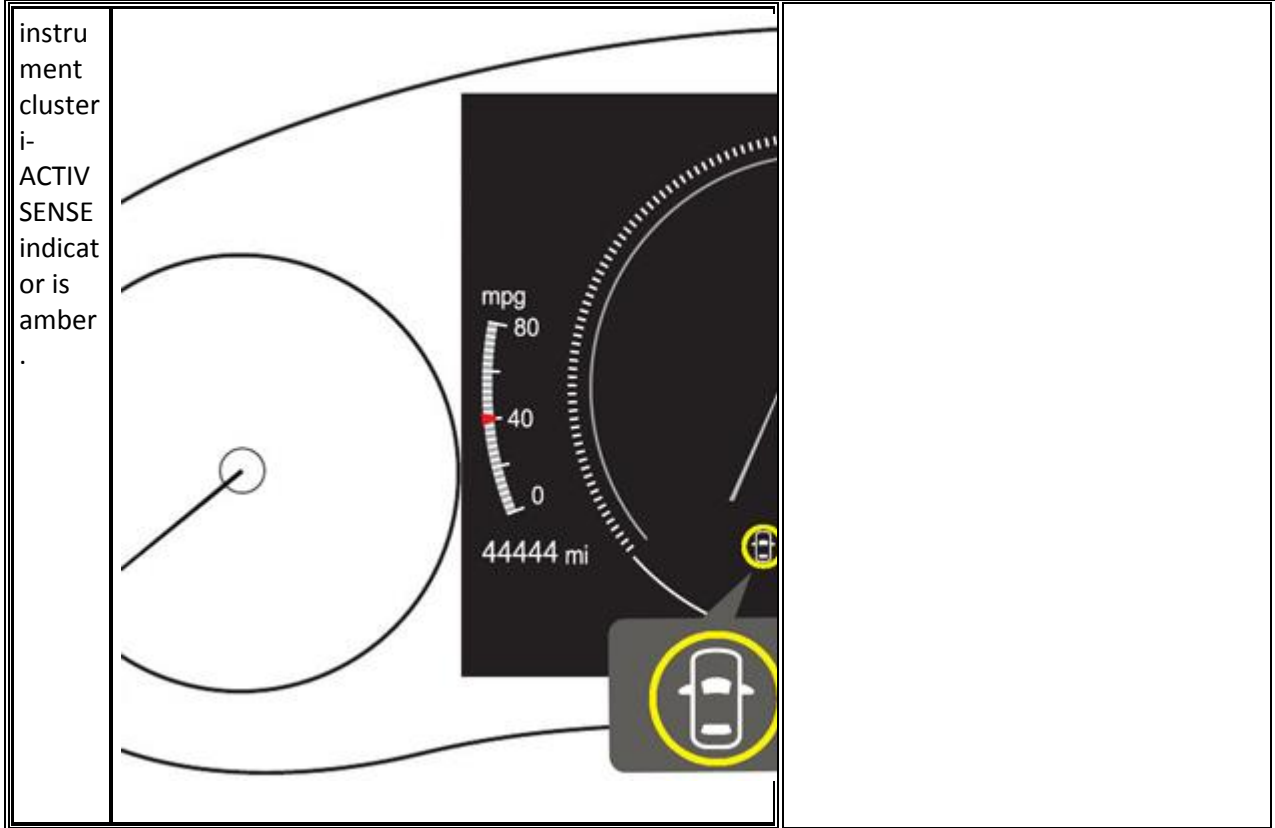

CONSUMER NOTICE: The information and instructions in this bulletin are intended for use by skilled technicians. Mazda technicians utilize the proper tools/equipment and take training to correctly and safely maintain Mazda vehicles. These instructions should not be performed by "do-it-yourselfers." Customers should not assume this bulletin applies to their vehicle or that their vehicle will develop the described concern. To determine if the information applies, customers should contact their nearest authorized Mazda dealership. Mazda North American Operations reserves the right to alter the specifications and contents of this bulletin without obligation or advance notice. All rights reserved. No part of this bulletin may be reproduced in any form or by any means, electronic or mechanical---including photocopying and recording and the use of any kind of information storage and retrieval system ---without permission in writing.

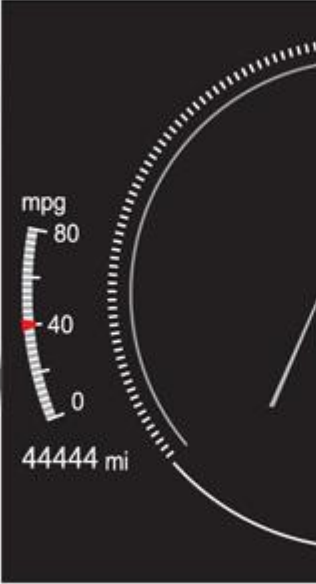
<p>When the i- ACTIV SENSE switch is presse d and releas ed immed iately, the followi ng syste ms are cancel ed.</p> <ol style="list-style-type: none">1. La ne De pa rtu re W ar ni ng Sy ste m (L D W S)2. Bli nd Sp ot M on	<p>Partially Cancelled Status: INDICATOR IS TURNED OFF</p> 	
---	---	--

CONSUMER NOTICE: The information and instructions in this bulletin are intended for use by skilled technicians. Mazda technicians utilize the proper tools/equipment and take training to correctly and safely maintain Mazda vehicles. These instructions should not be performed by "do-it-yourselfers." Customers should not assume this bulletin applies to their vehicle or that their vehicle will develop the described concern. To determine if the information applies, customers should contact their nearest authorized Mazda dealership. Mazda North American Operations reserves the right to alter the specifications and contents of this bulletin without obligation or advance notice. All rights reserved. No part of this bulletin may be reproduced in any form or by any means, electronic or mechanical---including photocopying and recording and the use of any kind of information storage and retrieval system ---without permission in writing.

ito rin g (B S M) 3. Dis ta nc e Sp ee d Al ert (D SA) 4. Re ar Cr os s Tr aff ic Al ert (R CT A) 5. La ne - ke ep As sis t Sy ste m (L		
--	--	--

CONSUMER NOTICE: The information and instructions in this bulletin are intended for use by skilled technicians. Mazda technicians utilize the proper tools/equipment and take training to correctly and safely maintain Mazda vehicles. These instructions should not be performed by "do-it-yourselfers." Customers should not assume this bulletin applies to their vehicle or that their vehicle will develop the described concern. To determine if the information applies, customers should contact their nearest authorized Mazda dealership. Mazda North American Operations reserves the right to alter the specifications and contents of this bulletin without obligation or advance notice. All rights reserved. No part of this bulletin may be reproduced in any form or by any means, electronic or mechanical---including photocopying and recording and the use of any kind of information storage and retrieval system ---without permission in writing.

<p>AS) To turn the syste m back to "Activ ated Status ", press the i- ACTIV SENSE switch once. NOTE: If MRCC is used, the syste m will also return to "Activ ated Status ".</p>		
<p>When the i- ACTIV SENSE switch is presse d and</p>	<p>Fully Cancelled Status: I-ACTIVSENSE INDICATOR IS OFF SBS OFF WARNING LIGHT IS ON</p>	

CONSUMER NOTICE: The information and instructions in this bulletin are intended for use by skilled technicians. Mazda technicians utilize the proper tools/equipment and take training to correctly and safely maintain Mazda vehicles. These instructions should not be performed by "do-it-yourselfers." Customers should not assume this bulletin applies to their vehicle or that their vehicle will develop the described concern. To determine if the information applies, customers should contact their nearest authorized Mazda dealership. Mazda North American Operations reserves the right to alter the specifications and contents of this bulletin without obligation or advance notice. All rights reserved. No part of this bulletin may be reproduced in any form or by any means, electronic or mechanical---including photocopying and recording and the use of any kind of information storage and retrieval system ---without permission in writing.

held,
all
systems are
cancelled.

1. Lane Departure Warning System (LDWS)
2. Blind Spot Monitoring (BSM)
3. Distance Speed

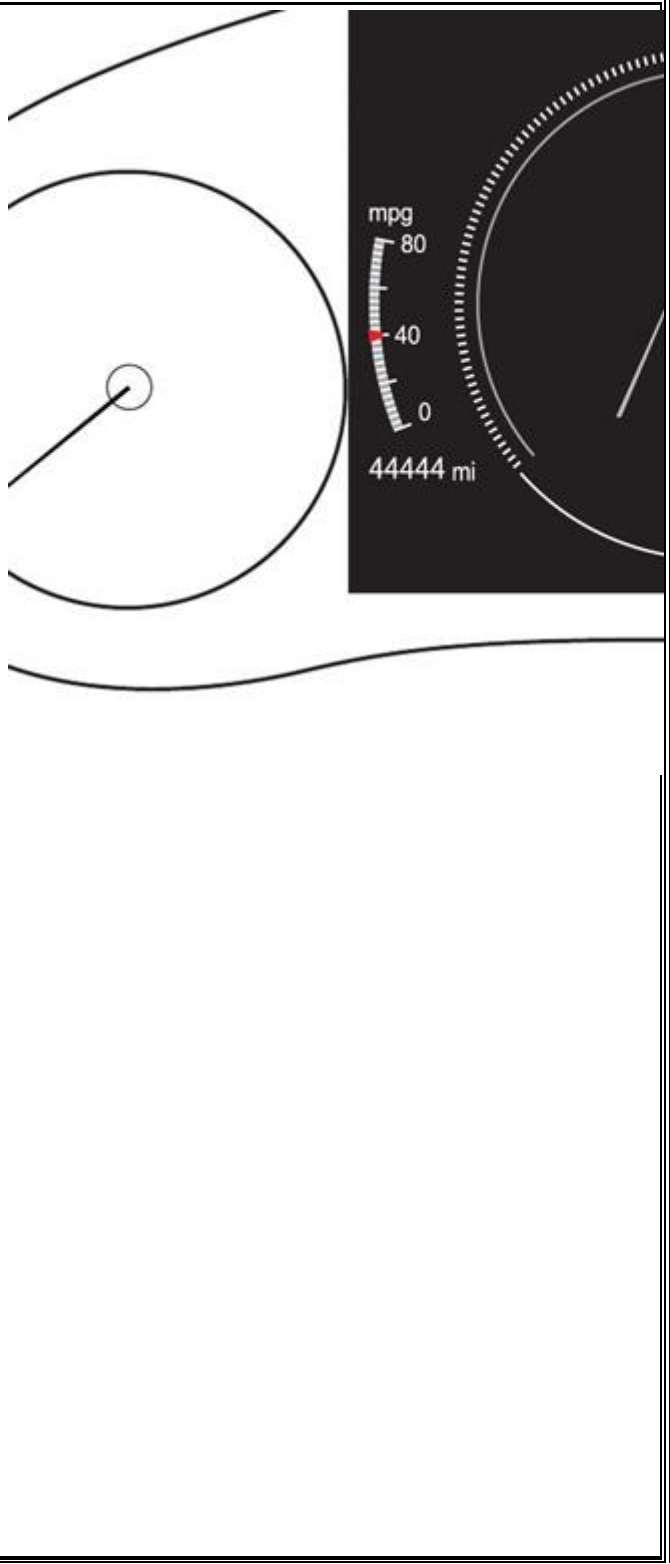

CONSUMER NOTICE: The information and instructions in this bulletin are intended for use by skilled technicians. Mazda technicians utilize the proper tools/equipment and take training to correctly and safely maintain Mazda vehicles. These instructions should not be performed by "do-it-yourselfers." Customers should not assume this bulletin applies to their vehicle or that their vehicle will develop the described concern. To determine if the information applies, customers should contact their nearest authorized Mazda dealership. Mazda North American Operations reserves the right to alter the specifications and contents of this bulletin without obligation or advance notice. All rights reserved. No part of this bulletin may be reproduced in any form or by any means, electronic or mechanical---including photocopying and recording and the use of any kind of information storage and retrieval system ---without permission in writing.

Alert (DSA)		
4. Rear Cross Traffic Alert		
(RCTA)		
5. Lane - keep Assist System (LAS)		
6. Smart Brake Support (S		

CONSUMER NOTICE: The information and instructions in this bulletin are intended for use by skilled technicians. Mazda technicians utilize the proper tools/equipment and take training to correctly and safely maintain Mazda vehicles. These instructions should not be performed by "do-it-yourselfers." Customers should not assume this bulletin applies to their vehicle or that their vehicle will develop the described concern. To determine if the information applies, customers should contact their nearest authorized Mazda dealership. Mazda North American Operations reserves the right to alter the specifications and contents of this bulletin without obligation or advance notice. All rights reserved. No part of this bulletin may be reproduced in any form or by any means, electronic or mechanical---including photocopying and recording and the use of any kind of information storage and retrieval system ---without permission in writing.

- BS
)
7. Smart Brake Support [Rear] (SBS-R)
- 8. Smart Brake Support [Rear Crosssing] (SBSRC)

CONSUMER NOTICE: The information and instructions in this bulletin are intended for use by skilled technicians. Mazda technicians utilize the proper tools/equipment and take training to correctly and safely maintain Mazda vehicles. These instructions should not be performed by "do-it-yourselfers." Customers should not assume this bulletin applies to their vehicle or that their vehicle will develop the described concern. To determine if the information applies, customers should contact their nearest authorized Mazda dealership. Mazda North American Operations reserves the right to alter the specifications and contents of this bulletin without obligation or advance notice. All rights reserved. No part of this bulletin may be reproduced in any form or by any means, electronic or mechanical---including photocopying and recording and the use of any kind of information storage and retrieval system ---without permission in writing.

Traffic Sign Recognition (TSR)

1. Traffic Sign Recognition (TSR) is only available on Canada Spec vehicles*
2. TSR is only available with a dealer installed in-vehicle navigation system accessory.

* Some Models

See Owner's Manual -> When Driving -> i-ACTIVSENSE -> i-ACTIVSENSE -> Traffic Sign Recognition System (TSR)

MGSS: Traffic Sign Recognition (TSR)

CONSUMER NOTICE: The information and instructions in this bulletin are intended for use by skilled technicians. Mazda technicians utilize the proper tools/equipment and take training to correctly and safely maintain Mazda vehicles. These instructions should not be performed by "do-it-yourselfers." Customers should not assume this bulletin applies to their vehicle or that their vehicle will develop the described concern. To determine if the information applies, customers should contact their nearest authorized Mazda dealership. Mazda North American Operations reserves the right to alter the specifications and contents of this bulletin without obligation or advance notice. All rights reserved. No part of this bulletin may be reproduced in any form or by any means, electronic or mechanical---including photocopying and recording and the use of any kind of information storage and retrieval system ---without permission in writing.

Speed Limit Alert

Note:

1. Speed Limit Alert function is only available with a dealer installed in-vehicle navigation system accessory.
2. Speed Limit Alert function is disabled when Apple CarPlay™ or Android Auto™ is connected.

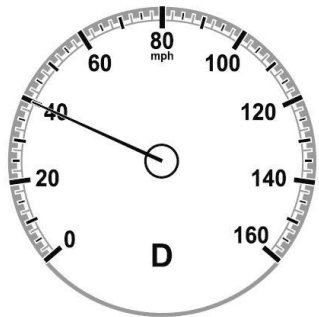
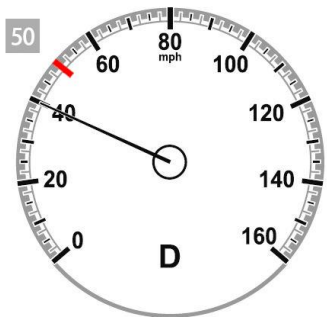
<p>Speed Limit</p>	<ol style="list-style-type: none"> 1. Not equipped with Navi SD Card 2. Is equipped but Navi Map does not have speed limit data* 3. Apple CarPlay™ or Android Auto™ is connected. 	
<p>Alert OFF (Default Setting)</p>	<ol style="list-style-type: none"> 1. Equipped with Navi SD Card 2. Navi Map has Speed Limit data* 3. Driving under the speed limit 4. Apple CarPlay™ or Android Auto™ is disconnected 	

CONSUMER NOTICE: The information and instructions in this bulletin are intended for use by skilled technicians. Mazda technicians utilize the proper tools/equipment and take training to correctly and safely maintain Mazda vehicles. These instructions should not be performed by "do-it-yourselfers." Customers should not assume this bulletin applies to their vehicle or that their vehicle will develop the described concern. To determine if the information applies, customers should contact their nearest authorized Mazda dealership. Mazda North American Operations reserves the right to alter the specifications and contents of this bulletin without obligation or advance notice. All rights reserved. No part of this bulletin may be reproduced in any form or by any means, electronic or mechanical---including photocopying and recording and the use of any kind of information storage and retrieval system ---without permission in writing.

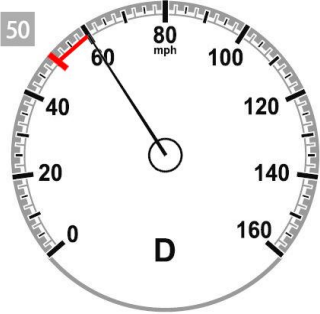
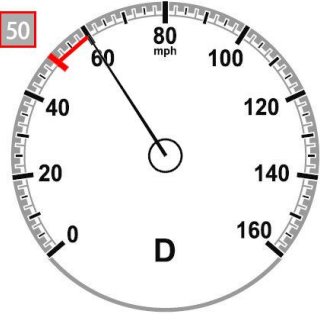
	<ol style="list-style-type: none"> 1. Equipped with Navi SD Card 2. Navi Map has Speed Limit data* 3. Driving over the speed limit 4. Apple CarPlay™ or Android Auto™ is disconnected 		
<p>Speed Limit Alert ON (Customer Setting Change)</p>	<ol style="list-style-type: none"> 1. Equipped with Navi SD Card 2. Navi Map has Speed Limit data* 3. Driving over the speed limit 4. Apple CarPlay™ or Android Auto™ is disconnected 		
<p>Speed Limit Alert Customer Settings</p> <ol style="list-style-type: none"> 1. Speed Limit Alert Settings <ol style="list-style-type: none"> 1. OFF 2. Visual 3. Visual + Audible 2. Speed Limit Alert Threshold <ol style="list-style-type: none"> 1. 0 mph 2. +5 mph 3. +10 mph <p>* SD Card maps may contain information about the speed limits of the roads. The navigation system is able to warn driver if they exceed the current limit. This information may not be</p>			

CONSUMER NOTICE: The information and instructions in this bulletin are intended for use by skilled technicians. Mazda technicians utilize the proper tools/equipment and take training to correctly and safely maintain Mazda vehicles. These instructions should not be performed by "do-it-yourselfers." Customers should not assume this bulletin applies to their vehicle or that their vehicle will develop the described concern. To determine if the information applies, customers should contact their nearest authorized Mazda dealership. Mazda North American Operations reserves the right to alter the specifications and contents of this bulletin without obligation or advance notice. All rights reserved. No part of this bulletin may be reproduced in any form or by any means, electronic or mechanical---including photocopying and recording and the use of any kind of information storage and retrieval system ---without permission in writing.

available in some areas or may not be fully correct for all roads on the map.

CONSUMER NOTICE: The information and instructions in this bulletin are intended for use by skilled technicians. Mazda technicians utilize the proper tools/equipment and take training to correctly and safely maintain Mazda vehicles. These instructions should not be performed by "do-it-yourselfers." Customers should not assume this bulletin applies to their vehicle or that their vehicle will develop the described concern. To determine if the information applies, customers should contact their nearest authorized Mazda dealership. Mazda North American Operations reserves the right to alter the specifications and contents of this bulletin without obligation or advance notice. All rights reserved. No part of this bulletin may be reproduced in any form or by any means, electronic or mechanical---including photocopying and recording and the use of any kind of information storage and retrieval system ---without permission in writing.

MAZDA CONNECT New Power Off Function



1. Audio Mute - Short press the volume knob (Press again to cancel)
2. Power Off - Press and hold the volume knob (Press and hold again to Power ON)

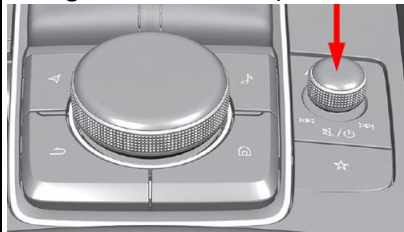

See Owner's Manual ->
Interior Features -> Mazda Connect

MGSS: ENTERTAINMENT SYSTEM

In-vehicle Owner's Manual installation

CONSUMER NOTICE: The information and instructions in this bulletin are intended for use by skilled technicians. Mazda technicians utilize the proper tools/equipment and take training to correctly and safely maintain Mazda vehicles. These instructions should not be performed by "do-it-yourselfers." Customers should not assume this bulletin applies to their vehicle or that their vehicle will develop the described concern. To determine if the information applies, customers should contact their nearest authorized Mazda dealership. Mazda North American Operations reserves the right to alter the specifications and contents of this bulletin without obligation or advance notice. All rights reserved. No part of this bulletin may be reproduced in any form or by any means, electronic or mechanical---including photocopying and recording and the use of any kind of information storage and retrieval system ---without permission in writing.

MAZDA CONNECT Center Display View

The rear-view monitor and Android Auto do not utilize all of the center display space.

Function	Display
MAZDA CONNECT FM	
Apple CarPlay	
Android Auto	
Rear View Monitor	

CONSUMER NOTICE: The information and instructions in this bulletin are intended for use by skilled technicians. Mazda technicians utilize the proper tools/equipment and take training to correctly and safely maintain Mazda vehicles. These instructions should not be performed by "do-it-yourselfers." Customers should not assume this bulletin applies to their vehicle or that their vehicle will develop the described concern. To determine if the information applies, customers should contact their nearest authorized Mazda dealership. Mazda North American Operations reserves the right to alter the specifications and contents of this bulletin without obligation or advance notice. All rights reserved. No part of this bulletin may be reproduced in any form or by any means, electronic or mechanical---including photocopying and recording and the use of any kind of information storage and retrieval system ---without permission in writing.

In-Vehicle Digital Owner's Manual

The in-vehicle digital OM can be displayed on the center display while the vehicle is stopped. Customer can search descriptions and watch videos of vehicle features and functions by operating the commander switch.

**NOTE:**

1. The digital owner's manual must be installed during PDI. Due to printing deadlines and later updates to the digital manual, the content of the digital manual may differ from the printed manual.
2. USB memory flash drive FAT16 or FAT32 format is required for installation.
3. The vehicle's infotainment system will only accept file names [contents.tar] and [contents.sig]. File names with additional suffixes will not be accepted.
4. The infotainment system may inadvertently be powered OFF if the diagnostic assist function buttons are not pressed correctly. Simply press and hold the volume knob to power back ON.

CONSUMER NOTICE: The information and instructions in this bulletin are intended for use by skilled technicians. Mazda technicians utilize the proper tools/equipment and take training to correctly and safely maintain Mazda vehicles. These instructions should not be performed by "do-it-yourselfers." Customers should not assume this bulletin applies to their vehicle or that their vehicle will develop the described concern. To determine if the information applies, customers should contact their nearest authorized Mazda dealership. Mazda North American Operations reserves the right to alter the specifications and contents of this bulletin without obligation or advance notice. All rights reserved. No part of this bulletin may be reproduced in any form or by any means, electronic or mechanical---including photocopying and recording and the use of any kind of information storage and retrieval system ---without permission in writing.

Navigation System

2019 Mazda3 is not equipped with factory installed navigation system, however, it is available as a dealer installed accessory.

NOTE: The 2019 Mazda3 accessory navigation SD is made in Japan instead of USA. If you use a made in the USA navigation SD card (for 6th gen) in the 2019 Mazda3, it will not function.



2019 Mazda3



Except 2019 Mazda3

SIRIUSXM Data Service No Free Trial (Preferred Package and above)

1. Only available as a paid subscription.
2. 2019 Mazda3 is not equipped with factory installed navigation system, however, it is available as a dealer installed accessory.
3. SiriusXM Traffic Plus feature requires in-vehicle navigation SD card.

See Owner's Manual -> Interior Features -> Mazda Connect -> Appendix

SA-007/19 - SIRIUSXM DATA SERVICES

CONSUMER NOTICE: The information and instructions in this bulletin are intended for use by skilled technicians. Mazda technicians utilize the proper tools/equipment and take training to correctly and safely maintain Mazda vehicles. These instructions should not be performed by "do-it-yourselfers." Customers should not assume this bulletin applies to their vehicle or that their vehicle will develop the described concern. To determine if the information applies, customers should contact their nearest authorized Mazda dealership. Mazda North American Operations reserves the right to alter the specifications and contents of this bulletin without obligation or advance notice. All rights reserved. No part of this bulletin may be reproduced in any form or by any means, electronic or mechanical---including photocopying and recording and the use of any kind of information storage and retrieval system ---without permission in writing.

Power Door Locks

Doors Lock With Keys In The Vehicle When Liftgate Lock Switch Is Pressed



DO NOT leave keys in the vehicle. The doors will lock with keys in the vehicle when liftgate lock switch is pressed and liftgate is closed, but the liftgate will not lock in the above condition.

NOTE: This is currently under investigation.

Doors cannot be unlocked using the outside door handle touch sensor



The door handle touch sensor system may not operate normally under the following conditions:

1. Front passenger (without key) grabs and holds the outside door handle before the driver (with key) touches the drivers outside door handle unlock touch sensor.
2. You touch the sensing area of the door lock touch sensor and the sensing area of the door release touch sensor at the same time.

See Owner's Manual ->
Before Driving -> Doors and Locks

Good	No Good

CONSUMER NOTICE: The information and instructions in this bulletin are intended for use by skilled technicians. Mazda technicians utilize the proper tools/equipment and take training to correctly and safely maintain Mazda vehicles. These instructions should not be performed by "do-it-yourselfers." Customers should not assume this bulletin applies to their vehicle or that their vehicle will develop the described concern. To determine if the information applies, customers should contact their nearest authorized Mazda dealership. Mazda North American Operations reserves the right to alter the specifications and contents of this bulletin without obligation or advance notice. All rights reserved. No part of this bulletin may be reproduced in any form or by any means, electronic or mechanical---including photocopying and recording and the use of any kind of information storage and retrieval system ---without permission in writing.

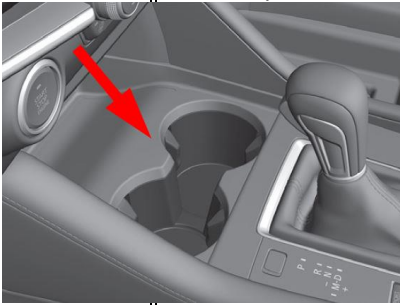
<p>Auxiliary Key The auxiliary keys need to be inserted into the transmitters during PDI.</p>	
<p>Auxiliary Key</p>  <p>NOTE: The auxiliary keys are small and could be overlooked during PDI.</p>	<p>Transmitter</p> 
<p>Vehicles arrive at the dealer with Auxiliary Keys located in the glove compartment*</p> 	<p>Vehicles arrive at the dealer with Transmitters located in the front cup holder*</p>  <p>-> Before Driving -></p>
<p>* Vehicles that arrive at the dealer after business hours, transmitters/auxiliary keys are located in the dealer's early bird key drop box.</p>	
<ol style="list-style-type: none"> 1. If one auxiliary key is lost, some key machines can trace cut a new replacement key. 2. If both auxiliary keys are lost, key machines cannot cut new replacement keys at this time. <ol style="list-style-type: none"> 1. Key machines will not recognize the key code for these new keys. 2. Mazda is aware of this issue and is working on a resolution. <p>Transmitter Note:</p> <ol style="list-style-type: none"> 1. If one transmitter is lost, inform the customer to take cautions not to lose the 2nd transmitter. 2. If both transmitters are lost, the vehicle will be disabled. 	

CONSUMER NOTICE: The information and instructions in this bulletin are intended for use by skilled technicians. Mazda technicians utilize the proper tools/equipment and take training to correctly and safely maintain Mazda vehicles. These instructions should not be performed by "do-it-yourselfers." Customers should not assume this bulletin applies to their vehicle or that their vehicle will develop the described concern. To determine if the information applies, customers should contact their nearest authorized Mazda dealership. Mazda North American Operations reserves the right to alter the specifications and contents of this bulletin without obligation or advance notice. All rights reserved. No part of this bulletin may be reproduced in any form or by any means, electronic or mechanical---including photocopying and recording and the use of any kind of information storage and retrieval system ---without permission in writing.

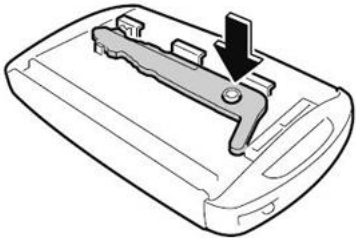
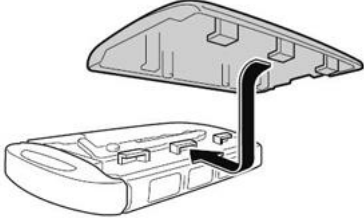
<ol style="list-style-type: none"> 1. MDARS is not able to program transmitters at this time. 2. Mazda is aware of this issue and is working on a resolution. <p>Insert the auxiliary key into the transmitter.</p>	
<p>Remove the transmitter lower cover by sliding the knob in the direction shown and then sliding the cover in the opposite direction.</p>	
<p>Insert the auxiliary key.</p>	
<p>Install the transmitter lower cover by inserting the tabs of the lower cover into the slots of the transmitter.</p>	

CONSUMER NOTICE: The information and instructions in this bulletin are intended for use by skilled technicians. Mazda technicians utilize the proper tools/equipment and take training to correctly and safely maintain Mazda vehicles. These instructions should not be performed by "do-it-yourselfers." Customers should not assume this bulletin applies to their vehicle or that their vehicle will develop the described concern. To determine if the information applies, customers should contact their nearest authorized Mazda dealership. Mazda North American Operations reserves the right to alter the specifications and contents of this bulletin without obligation or advance notice. All rights reserved. No part of this bulletin may be reproduced in any form or by any means, electronic or mechanical---including photocopying and recording and the use of any kind of information storage and retrieval system ---without permission in writing.

Transmitter Battery Saving Function (Key Fob)

The new 2019 Mazda3 has a "power saving" function built into the keyless entry system where some key fob functions are disabled. This feature could accidentally be enabled and some concerns with the vehicle may be:

1. Engine does not start.
2. Engine does not start unless you hold the fob to the start/stop button.
3. Doors do not unlock using the door handle, but unlock with the remote.
4. Doors do not lock using the door handle, but lock with the remote.
5. Transmitter indicator light does not turn on/flash.

Turning on the power saving function
After you have turned on the power saving function according to the following procedure, the hazard warning lights and sound operate* one time.

1. Press the lock button on the transmitter 4 times within 3 seconds to turn on the operation indicator light.
2. Press the lock button continuously for 1.5 seconds or longer while the operation indicator light turns on (for 5 seconds).
3. Press any of the buttons on the transmitter to make sure that the operation indicator light does not turn on/flash.

Turning off the power saving function
After you have turned off the power saving function according to the following procedure, the hazard warning lights and sound operate* one time.

1. Press any of the buttons on the transmitter to make sure that the operation indicator light does not turn on/flash.
2. Press the lock button on the transmitter 4 times within 3 seconds to turn on the operation indicator light.
3. Press the lock button continuously for 1.5 seconds or longer while the operation indicator light turns on (for 5 seconds).

*: with the advanced keyless function

Also see Owner's Manual ->

CONSUMER NOTICE: The information and instructions in this bulletin are intended for use by skilled technicians. Mazda technicians utilize the proper tools/equipment and take training to correctly and safely maintain Mazda vehicles. These instructions should not be performed by "do-it-yourselfers." Customers should not assume this bulletin applies to their vehicle or that their vehicle will develop the described concern. To determine if the information applies, customers should contact their nearest authorized Mazda dealership. Mazda North American Operations reserves the right to alter the specifications and contents of this bulletin without obligation or advance notice. All rights reserved. No part of this bulletin may be reproduced in any form or by any means, electronic or mechanical---including photocopying and recording and the use of any kind of information storage and retrieval system ---without permission in writing.

Before Driving -> Keys -> Power saving function

CONSUMER NOTICE: The information and instructions in this bulletin are intended for use by skilled technicians. Mazda technicians utilize the proper tools/equipment and take training to correctly and safely maintain Mazda vehicles. These instructions should not be performed by "do-it-yourselfers." Customers should not assume this bulletin applies to their vehicle or that their vehicle will develop the described concern. To determine if the information applies, customers should contact their nearest authorized Mazda dealership. Mazda North American Operations reserves the right to alter the specifications and contents of this bulletin without obligation or advance notice. All rights reserved. No part of this bulletin may be reproduced in any form or by any means, electronic or mechanical---including photocopying and recording and the use of any kind of information storage and retrieval system ---without permission in writing.

Keyless Entry Using Auxiliary Key

If the vehicle battery is discharged and/or the key battery is dead, vehicle entry is possible using the auxiliary key.

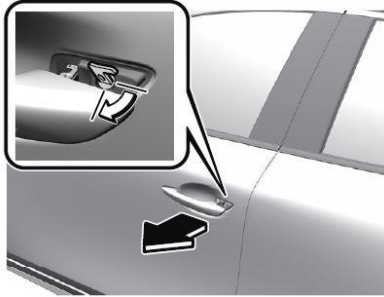

See Owner's Manual ->
Before Driving -> Keys -> Auxiliary Key

Then refer to Owner's Manual ->
Before Driving -> Doors and Locks ->
Unlocking with Auxiliary Key

Rear Door Child Safety Locks Operation

The auxiliary key is required to enable (lock) and disable (unlock) the rear door child safety locks.



1. Auxiliary Key

2. Lock

3. Unlock

See Owner's Manual ->
Before Driving -> Doors and Locks ->
Rear Door Child Safety Locks

CONSUMER NOTICE: The information and instructions in this bulletin are intended for use by skilled technicians. Mazda technicians utilize the proper tools/equipment and take training to correctly and safely maintain Mazda vehicles. These instructions should not be performed by "do-it-yourselfers." Customers should not assume this bulletin applies to their vehicle or that their vehicle will develop the described concern. To determine if the information applies, customers should contact their nearest authorized Mazda dealership. Mazda North American Operations reserves the right to alter the specifications and contents of this bulletin without obligation or advance notice. All rights reserved. No part of this bulletin may be reproduced in any form or by any means, electronic or mechanical---including photocopying and recording and the use of any kind of information storage and retrieval system ---without permission in writing.

Seat Warmer and Heated Steering Wheel Auto Mode
 The driver and front passenger's seater warmers* and the heated steering wheel* can be set to be automatically controlled (turned on and off) by the climate control system, depending on the set temperature.

Auto Mode

1. Go to MAZDA CONNECT home screen and select "Settings"
2. Select "Vehicle Settings".
3. Enable "Link Seat Climate Control Temperatures".
4. Press the climate control AUTO switch.

Link Seat Climate Control Temperatures Setting



Climate Control Auto Switch

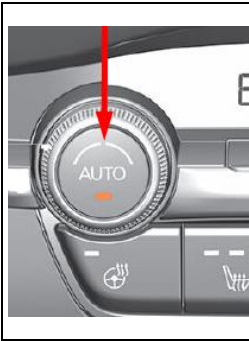

* if equipped

See Owner's Manual ->
 Essential Safety Equipment -> Seat Warmer/Heated Steering Wheel -> Seat Warmer / Heated Steering Wheel

CONSUMER NOTICE: The information and instructions in this bulletin are intended for use by skilled technicians. Mazda technicians utilize the proper tools/equipment and take training to correctly and safely maintain Mazda vehicles. These instructions should not be performed by "do-it-yourselfers." Customers should not assume this bulletin applies to their vehicle or that their vehicle will develop the described concern. To determine if the information applies, customers should contact their nearest authorized Mazda dealership. Mazda North American Operations reserves the right to alter the specifications and contents of this bulletin without obligation or advance notice. All rights reserved. No part of this bulletin may be reproduced in any form or by any means, electronic or mechanical---including photocopying and recording and the use of any kind of information storage and retrieval system ---without permission in writing.

Electric Parking Brake (EPB)

Parking Brake Auto Operation

When the ignition is switched OFF, the parking brake will be applied automatically. The EPB indicator light in the instrument cluster and the EPB switch indicator light turn ON.



1. Indicator light

Canceling the Parking Brake Auto Operation

Parking brake auto operation can be canceled using the procedure in the Owner's Manual.

NOTE: When the ignition is cycled back ON, the parking brake auto operation is restored.

Parking Brake Automatic Release

If the accelerator pedal is depressed with the parking brake applied and all of the following conditions are met, the parking brake is automatically release. When the parking brake is released, the EPB indicator light in the instrument cluster and the EPB switch indicator light turn off.

See Owner's Manual -> When Driving -> Brake -> EPB Auto operation

A/T	M/T
Engine is running	
Driver's door is closed	
Driver's seat belt is fastened	
Selector lever is in the D, M, or R position	Shift lever is in a position other than neutral
	Clutch pedal is depressed halfway

CONSUMER NOTICE: The information and instructions in this bulletin are intended for use by skilled technicians. Mazda technicians utilize the proper tools/equipment and take training to correctly and safely maintain Mazda vehicles. These instructions should not be performed by "do-it-yourselfers." Customers should not assume this bulletin applies to their vehicle or that their vehicle will develop the described concern. To determine if the information applies, customers should contact their nearest authorized Mazda dealership. Mazda North American Operations reserves the right to alter the specifications and contents of this bulletin without obligation or advance notice. All rights reserved. No part of this bulletin may be reproduced in any form or by any means, electronic or mechanical---including photocopying and recording and the use of any kind of information storage and retrieval system ---without permission in writing.

A/C Air Temperature Is Not Cold

When diagnosing A/C performance complaints, use a thermometer as shown below and only compare A/C performance to another vehicle that is the same model/year/HVAC type*.

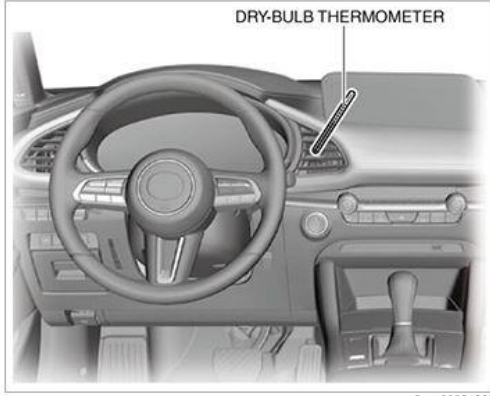

*HVAC Types:

1. FULL-AUTO AIR CONDITIONER
2. MANUAL AIR CONDITIONER

MGSS: REFRIGERANT SYSTEM PERFORMANCE TEST [(US)]

Tire Pressure Monitoring System (TPMS) Change

The TPMS system uses a new rubber type direct TPMS.

NOTE: The new rubber type is not reusable. If the TPMS sensor is removed from the wheel, it must be replaced.



New Rubber Type Old Metal Type

MGSS: TIRE PRESSURE MONITORING SYSTEM (TPMS)

CONSUMER NOTICE: The information and instructions in this bulletin are intended for use by skilled technicians. Mazda technicians utilize the proper tools/equipment and take training to correctly and safely maintain Mazda vehicles. These instructions should not be performed by "do-it-yourselfers." Customers should not assume this bulletin applies to their vehicle or that their vehicle will develop the described concern. To determine if the information applies, customers should contact their nearest authorized Mazda dealership. Mazda North American Operations reserves the right to alter the specifications and contents of this bulletin without obligation or advance notice. All rights reserved. No part of this bulletin may be reproduced in any form or by any means, electronic or mechanical---including photocopying and recording and the use of any kind of information storage and retrieval system ---without permission in writing.

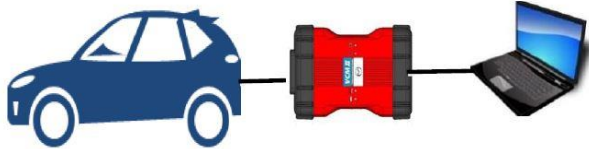
<p>Condition Based Maintenance (Except Canada) The vehicle calculates the maintenance (oil change) timing.</p> <ol style="list-style-type: none"> 1. This function cannot be turned OFF. 2. Distance until the oil change is available in MAZDA CONNECT. 3. Reset is required after every oil change. 	<p>MGSS: MAINTENANCE MONITOR OPERATION PROCEDURE</p>
<p>New M-MDS (MDARS) A new M-MDS diagnostic tester (MDARS) for 7th generation vehicles (starting with the 2019 Mazda3) is used.</p> <ol style="list-style-type: none"> 1. Performs more maintenance service functions 2. Performs more complicated vehicle electrical system diagnostic 3. Reprograms more ECU's 	<p>MGSS: BASIC KNOWLEDGE</p>
<p>Parts Replacement When replacing vehicle parts such as ECU's, motors, seats....etc, always refer to MGSS. Some new components may not operate if MGSS new part replacement procedure is not performed.</p>	<p>---</p>

CONSUMER NOTICE: The information and instructions in this bulletin are intended for use by skilled technicians. Mazda technicians utilize the proper tools/equipment and take training to correctly and safely maintain Mazda vehicles. These instructions should not be performed by "do-it-yourselfers." Customers should not assume this bulletin applies to their vehicle or that their vehicle will develop the described concern. To determine if the information applies, customers should contact their nearest authorized Mazda dealership. Mazda North American Operations reserves the right to alter the specifications and contents of this bulletin without obligation or advance notice. All rights reserved. No part of this bulletin may be reproduced in any form or by any means, electronic or mechanical---including photocopying and recording and the use of any kind of information storage and retrieval system ---without permission in writing.