

- ATTENTION:**
- GENERAL MANAGER
  - PARTS MANAGER
  - CLAIMS PERSONNEL
  - SERVICE MANAGER

IMPORTANT - All Service Personnel Should Read and Initial in the boxes provided, right.

© 2019 Subaru of America, Inc. All rights reserved.



QUALITY DRIVEN® SERVICE

**PRODUCT CAMPAIGN BULLETIN**

**APPLICABILITY:** 2019MY Forester and Crosstrek Vehicles      **NUMBER:** **WUC-88R**  
**SUBJECT:** Power Steering Gear Box Inspect/Replacement      **DATE:** 02/12/19  
**REVISED:** 03/22/19  
**NHTSA ID:** 19V-065

**INTRODUCTION:**

Subaru of America, Inc. is recalling certain 2019 model year Forester and Crosstrek vehicles to inspect and, if necessary, replace the power steering gear box. A total of 10,417 U.S. vehicles will be affected by this recall.

**AFFECTED VEHICLES**

Coverage for all affected vehicles must be confirmed by using the Vehicle Coverage Inquiry function on subarunet.com.

***This information is now available for all affected VINs currently in the system.***

Model Year	Carline	Production Range	Vehicle count
2019	Forester	December 27, 2018 – January 16, 2019	6,277
2019	Crosstrek	December 27, 2018 – January 16, 2019	4,140

Please be advised that as additional affected VINs are processed into the system, coverage for those vehicles will be made available.

**DESCRIPTION OF THE DEFECT AND SAFETY RISK**

A connector inside the Electronic Power Steering (EPS) control unit may form small gaps in the plastic material molding during the manufacturing process. As a result, connector terminals inside the plastic molding may have inadequate isolation between terminals.

If a loss in isolation occurs, the EPS warning lamp will illuminate, and the EPS assist may be disabled. Disabling of the EPS assist could result in higher steering effort, increasing the risk of a crash.

*Continued...*

<p><b>CAUTION: VEHICLE SERVICING PERFORMED BY UNTRAINED PERSONS COULD RESULT IN SERIOUS INJURY TO THOSE PERSONS OR TO OTHERS.</b></p> <p>Subaru Service Bulletins are intended for use by professional technicians ONLY. They are written to inform those technicians of conditions that may occur in some vehicles, or to provide information that could assist in the proper servicing of the vehicle. Properly trained technicians have the equipment, tools, safety instructions, and know-how to do the job correctly and safely. If a condition is described, DO NOT assume that this Service Bulletin applies to your vehicle, or that your vehicle will have that condition.</p>	<p><b>Subaru of America, Inc. is ISO 14001 Compliant</b></p> <p>ISO 14001 is the international standard for excellence in Environmental Management Systems. Please recycle or dispose of automotive products in a manner that is friendly to our environment and in accordance with all local, state and federal laws and regulations.</p>
--	--

*Continued...*

## DESCRIPTION OF THE REMEDY

Retailers will inspect the steering gear box on these vehicles in accordance with the specified repair procedure and if necessary, replace it with a corrected one.

## RETAILER RESPONSIBILITY

Retailers are to promptly perform the applicable service procedures to correct all affected vehicles in their inventory. Any vehicles listed in a recall/campaign that are in the retailer's stock must be:

- Immediately identified.
- Tagged or otherwise marked to prevent their delivery or use prior to inspection and, if necessary, repair.
- Repaired in accordance with the repair procedures outlined in this Product Campaign Bulletin.

**Please be advised that it is a violation of Federal law for a dealer to deliver a new motor vehicle covered by a recall under a sale or lease until the defect is remedied. Therefore, any Authorized Subaru Retailer failing to perform the applicable service procedures to correct all affected vehicles in their inventory prior to the vehicle being placed in service may be subject to civil penalties of up to \$21,000 per violation (i.e., for each vehicle), as provided in 49 CFR §578.6 and will also be in breach of the Subaru Dealer Agreement.**

## OWNER NOTIFICATION

An owner notification will not be necessary because all affected vehicles will be inspected and/or repaired prior to retail sale.

## RETAILER AFFECTED VIN LISTS

Each retailer will receive a detailed list of affected units from their Region/Distributor.

## SERVICE PROCEDURE:

This Service Campaign involves inspection and possible replacement of the EPS gear box assembly. The required repair will depend on the results of an inspection of the Lot Number shown on a label affixed to the EPS assembly. The label and Lot Number are easily seen from under the vehicle. If the Lot Number is within the specific range provided in the Service Procedure below, the EPS gear box (steering rack) assembly must be replaced.

These vehicles can be quickly identified upon receipt by the presence of an "S" label with blue background on the windshield as shown here. While all affected vehicles should have this label installed at the ports, retailers should always check arriving potentially applicable vehicles using vehicle inquiry to confirm if there are any open recalls/campaigns to be completed. In a small number of cases, an "S" written with a glass marker may be found on the windshield in place of the sticker.

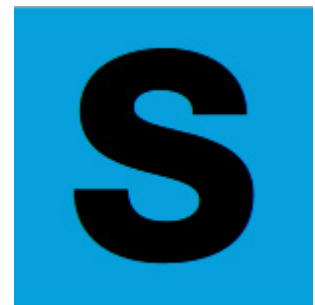

*Continued...*

**PART INFORMATION:**

**NOTE: There is no need for retailers to order any of these parts.** Parts needed to complete this procedure (both the EPS assembly and Hardware Kit) will be shipped automatically to each Retailer based upon vehicle allocation. **Vehicles trades between Retailers prior to completion of this repair should be avoided as doing so may delay proper parts supply for the receiving Retailer.**

Description	Part Number	Application
STEERING GEAR BOX ASSEMBLY- EPS	34110SJ040	FORESTER
	34110FL130	CROSSTREK
WUC-88 HARDWARE KIT*	SOA635317	ALL

\*The HARDWARE KIT consists of the following components:

Description	Part Number	Quantity	Notes
FLANGE BOLT	901000462	4	EPS Gear Box Mounting Bolts
COTTER PIN	051030300 <u>OR</u> 051030200	2	Cotter Pins- Part numbers are interchangeable, OK to mix.
FLANGE NUT	902380017	2	Stabilizer End Link Nut
GASKET-EXHAUST PIPE FRONT	44616AA290	1	Exhaust Pipe Gaskets
GASKET-EXHAUST PIPE REAR	44022AA123	1	

**REPAIR PROCEDURE:**

- 1) After confirming applicability, raise the vehicle on a lift.
- 2) The EPS Label and Lot Number are accessible through a hole in the crossmember support as shown.

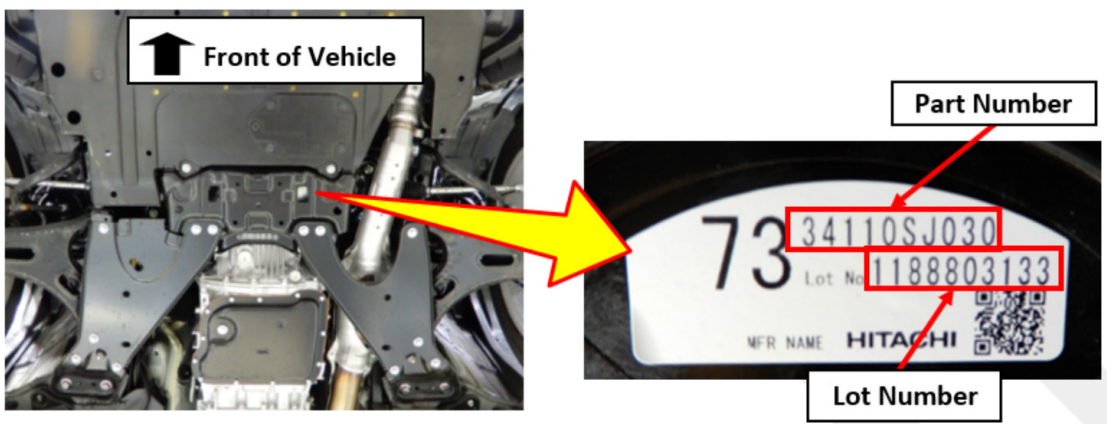

*Continued...*

3) Inspect the label for black dots to the left of the QR code as shown.



If inspection reveals a label with TWO (2) dots, **REGARDLESS OF LOT NUMBER**, the Service Procedure is complete. **CAREFULLY** copy the Lot Number onto the Repair Order as it will be needed for Claim Submission. Proceed to Claim Reimbursement and Entry Procedures to process the claim for Inspection Only.

If inspection reveals a label with either NO or only ONE dot, **CAREFULLY** copy the Lot Number onto the Repair Order then compare it to the ranges provided below. **NOTE:** Parts within these lot number ranges may be found on either Crosstrek or Forester as both of the vendor's production lines produce parts for both carlines.

4) Start of Range – End of Range:

1188Z21674 – 1198199999

118XZ10278 - 119X199999

If the Lot Number falls within either of these ranges, the EPS assembly **MUST** be replaced.

**CRITICAL: Do Not make the OK or NG determination by using just the 5-digit sequence number at the end of the Lot Number.**

Use the image below for interpreting the Lot Number of the EPS gear box assembly.

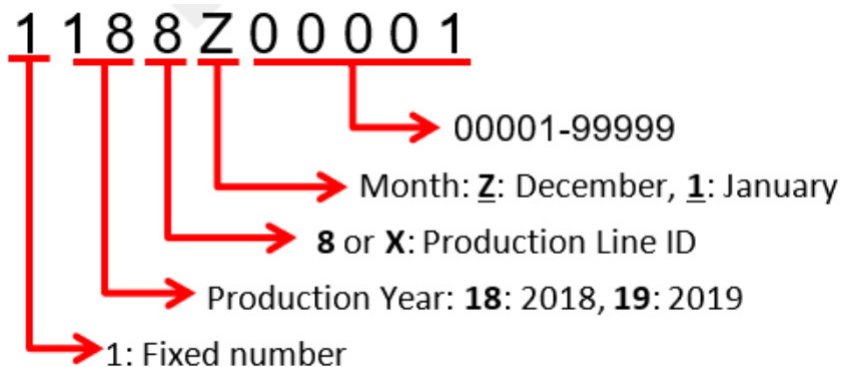

**REMINDER: If inspection reveals a label with TWO (2) dots, REGARDLESS OF LOT NUMBER, the Service Procedure is complete.**

*Continued...*

## Pre-Installation EPS Gearbox Inspection:

**VERY IMPORTANT:** The following brief inspection procedure below of the new part **MUST** be performed **BEFORE** installation of the new EPS gear box assembly.

There is a VERY SMALL possibility the EPS gear box assembly was not properly centered before the plastic retainer was installed during manufacturing. If this occurs:

- it may be difficult to match up the marks when re-connecting the EPS gear box assembly to the steering shaft
- the number of turns between full steering lock left and right will be different
- one tie-rod boot will be collapsed (or extended) more than the other.

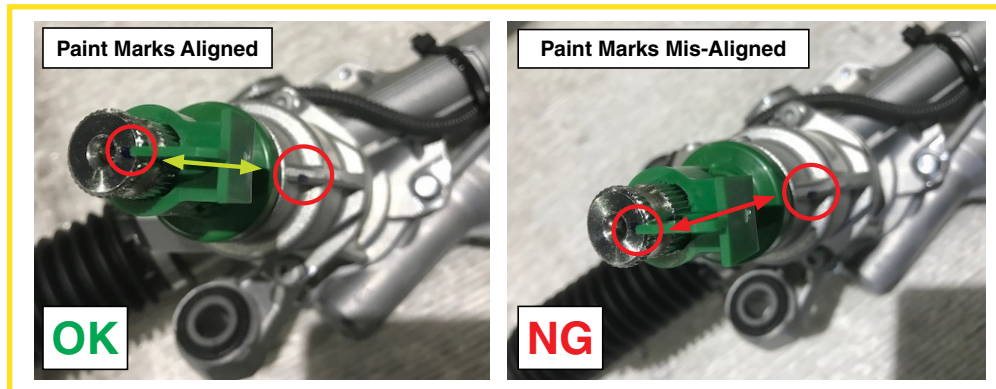

### NOTES:

- If a **NG** condition is identified, see **APPENDIX A** on page 9 of this bulletin for the **EPS Gear Box Centering Procedure**.
  - Although the plastic retainer cap is white in the photos, it will likely be either green or blue depending on application.
5. When the Lot Number inspection procedure determines the EPS gear box assembly requires replacement, follow the procedure in the applicable Service Manual along with the Helpful Hints provided below. Pay close attention to the items listed as one-time-use. They are all supplied in the Hardware Kit and **MUST** be replaced during reassembly.

After installation, with the front wheels pointed straight ahead, turn the steering wheel full lock right then full lock left and confirm there is no difference in the number of turns required to reach the stops.

### IMPORTANT PRECAUTIONS:

- **The EPS control module continues to operate after the engine stops. Therefore, before starting service of the EPS system which requires disconnection of the wiring harness connector, the ground cable **MUST** be disconnected from the battery.**
  - **Be careful not to let any foreign matter (dust, water, oil, etc.) enter the power steering control module wiring harness connector when removing or installing it. If any foreign matter enters, always be sure completely remove it before re-connecting.**
6. **VERY IMPORTANT:** After adjusting the toe-in and steering wheel angle, tighten the lock nut on the tie rod end, always perform the Active Lane Keep System Learning Value clear (models with EyeSight) and the VDC sensor midpoint setting mode following the steps below and the applicable Service Manual.

*Continued...*



- **Perform Active Lane Keep System Learning Value Clear:**

- 1) Connect the Subaru Select Monitor (SSM).
- 2) Turn the ignition switch to ON.
- 3) From the [Start] screen, select [Diagnosis].
- 4) On [Select Vehicle] screen, input the target vehicle information and select [Set].
- 5) On [Main Menu] screen, select [Each System].
- 6) Select [EyeSight].
- 7) Select [Work Support].
- 8) Select [Clear Active Lane Keep System Learning Value].

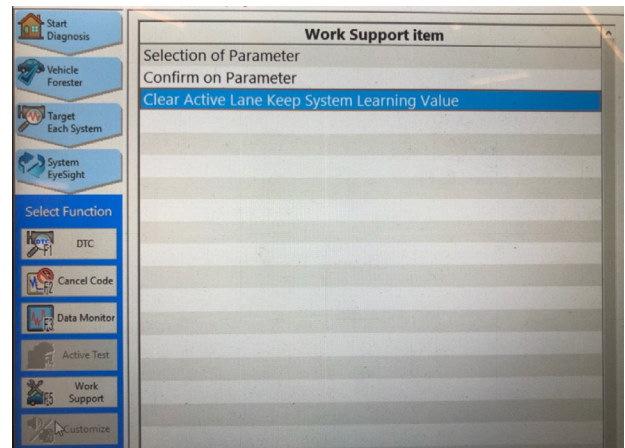

- **Perform VDC Sensor 0 Point Setting Mode:**

- 1) Connect the Subaru Select Monitor (SSM).
- 2) Turn the ignition switch to ON.
- 3) From the [Start] screen, select [Diagnosis].
- 4) On [Select Vehicle] screen, input the target vehicle information and select [Set].
- 5) On [Main Menu] screen, select [Each System].
- 6) On [Select System] screen, select [Brake Control], and then select [Enter].
- 7) On [Select Function] screen, select [Data monitor].
- 8) From the Data Monitor list, select [Steering Angle Sensor], [Longitudinal G Sensor] and [Lateral G Sensor].
- 9) Check that the steering angle sensor output value is "0" +/- 2 degrees. **If the output value is different from the standard value, re-check the steering wheel position.**
- 10) Check that the output values for the longitudinal G sensor and lateral G sensor are  $-2 \text{ — } 2 \text{ m/s}^2$ . **If the output value is different from the standard value, check the installing condition of the hydraulic unit assembly VDC and the bracket COMPL hydraulic unit VDC.**
- 11) On [Select Function] screen, select [Work Support].
- 12) From the work support item list, select [VSC(VDC) Centering Mode], and perform the setting according to the procedure displayed on the Subaru Select Monitor screen.

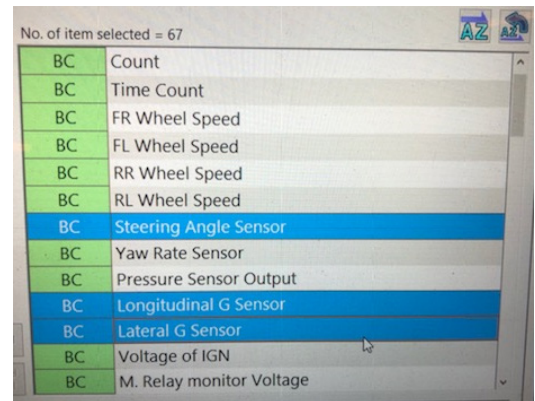

Item	Value	Unit
BC Trip Count	71	Time
BC Count	Common	
BC Time Count	454400	ms
BC FR Wheel Speed	0.0	MPH
BC FL Wheel Speed	0.0	MPH
BC RR Wheel Speed	0.0	MPH
BC RL Wheel Speed	0.0	MPH
BC Steering Angle Sensor	-1.0	deg
BC Yaw Rate Sensor	0.0	deg/s
BC Pressure Sensor Output	0.0	bar
BC Longitudinal G Sensor	0.0	m/s <sup>2</sup>
BC Lateral G Sensor	0.0	m/s <sup>2</sup>
BC Voltage of IGN	14.0	V

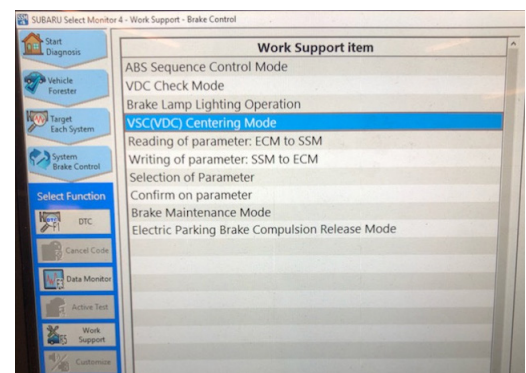

*Continued...*

**IMPORTANT:** Drive the vehicle for 10 minutes to confirm:

- there are no system malfunctions
- no warning light illumination
- no other DTC(s) are stored.

7. The original (removed) EPS gear box assembly will not be collected therefore, it MUST be “field scrapped” to render it unusable before discarding. See **APENDIX A** on page 10 of this bulletin for the proper procedure to follow.

**Helpful Hints When Performing EPS Assembly Replacement:**

- Always confirm the part number on the steering gear box assembly label is correct for the vehicle being repaired **BEFORE** installation.
- **REMINDER:** If **TWO** black dots are identified on the label as shown above, the part EPS assembly does **NOT** need to be replaced.
- Remove the left and right stabilizer link lower nuts but do **NOT** remove the stabilizer bar itself. These 2 nuts are 1-time-use, included in the Hardware Kit and **MUST** be replaced at reassembly.

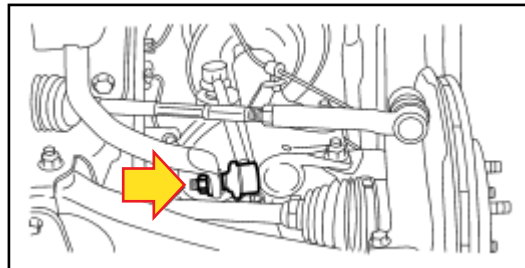

- Loosen the (upper) universal joint bolt on the steering column side but do **NOT** remove it. Leave the universal joint on the vehicle side and remove the steering gear box.

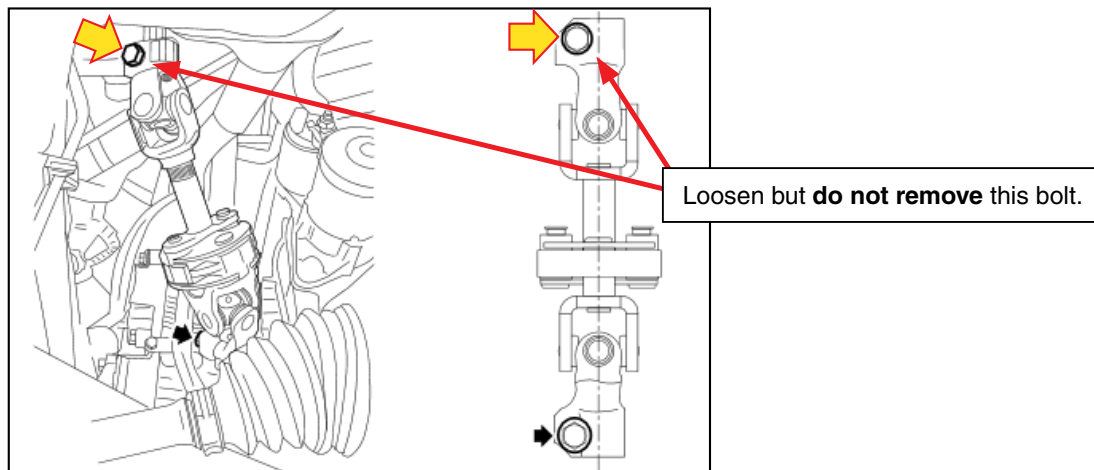

- **DO NOT** separate the Lower control arm from the knuckle housing. Otherwise, additional parts will be necessary to complete the work and not only toe, but a complete wheel alignment / adjustment will be necessary.

*Continued...*

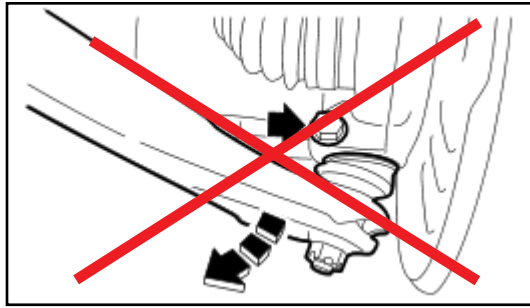

- **This repair requires a toe adjustment only.** A four-wheel alignment is only necessary if there is deviation from the standard Service Manual procedures.

**CLAIM REIMBURSEMENT AND ENTRY PROCEDURES:**

Credit to perform this service campaign will be based on the submission of properly completed repair order information. Retailers may submit claims through Vehicle Claim Entry on [subarunet.com](http://subarunet.com).

Labor Description	Labor Operation #	Labor Time	Fail Code	Claim Type
EPS ASSEMBLY- LOT NUMBER INSPECTION ONLY	A165-948	0.2	WUC-88	RC
EPS ASSEMBLY- LOT NUMBER INSPECTION & GEAR BOX ASSEMBLY REPLACEMENT <b>(INCLUDES Toe Adjustment)</b>	165-940	2.3		

**NOTE:** The Lot Number from the ORIGINAL Factory-installed EPS assembly MUST be entered in the Miscellaneous Detail field at Claim submission.

**IMPORTANT REMINDERS:**

- SOA strongly discourages the printing and/or local storage of service information as previously released information and electronic publications may be updated at any time.
- Always check for any open recalls or campaigns anytime a vehicle is in for servicing.
- Always refer to STIS for the latest service information before performing any repairs.

*Continued...*



## APPENDIX A

This Appendix includes:

- **EPS Gear Box Centering Procedure**
- **Original (removed) EPS Gear Box Field Scrap Procedure**

### Centering Procedure:

There is small possibility the steering gear box center position may be incorrect on the new replacement EPS gear box. This condition could cause the following two issues:

- Difficult to match the paint markings when connecting the gear box and the steering shaft.
  - The steering angle (number of turns) to full steer left and right may be different.
1. Before installing the new EPS gear box, confirm the input shaft paint mark and the housing paint mark are aligned as shown in the OK photo below.
  2. Confirm the tie rods and boots are the same length, left and right.

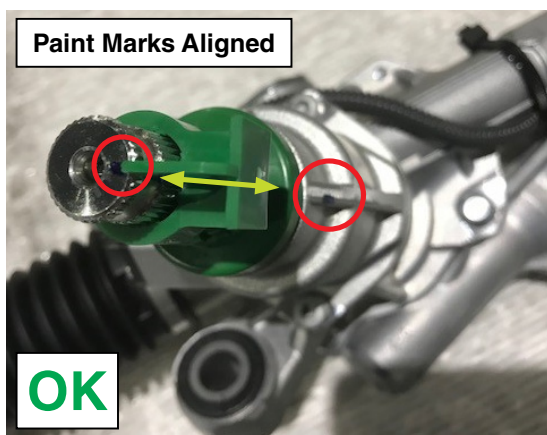

### If the EPS Gear Box needs to be centered:

- CAREFULLY remove the resin cap.
- Using SST 34099PA100, turn the input shaft to align the marks then reinstall the resin cap.

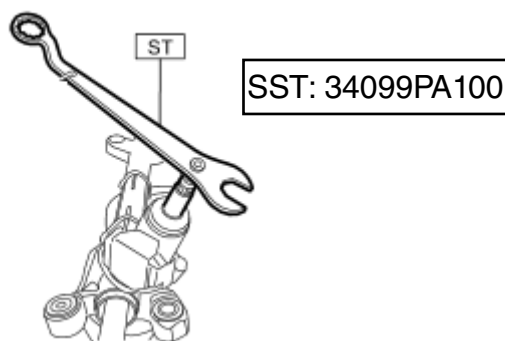

*Continued...*

**EPS Gear Box Field Scrap Procedure:**

Cut the wiring harness completely off the original rack assembly as close as possible to where it attaches to the pinion housing area as shown below and discard.

