

REFERENCE:	Nova Bus Manuals
SECTION:	16: Electrical system
RS N°:	MQR 7621-1331
EFFECTIVE IN PROD.:	LB45 (2018AL)

APPLICATION DEADLINE:N/A

SUBJECT:	Throttle pedal sensors (TPS) cable replacement			
JUSTIFICATION:	Cummins code 1242 for throttle pedal sensor circuit			
LEVEL	DESCRIPTION	DIRECT CHARGES		TIME
		LABOUR	MATERIAL	
1	Install the throttle pedal sensor bypass cable.	Client	Client	2.75 h
2	Install the throttle pedal sensor front to back cable.	Client	Client	16 h

MATERIAL

QTY	PART N°	REV.	DESCRIPTION	REPLACES PART N°
LEVEL 1				
1	N632000435	B	Bypass cable (wire kit)	–
5	G5007995	-	Black tie wrap	–
8	G5007996	-	Black tie wrap	–
0.8m	N27548-18	-	Heat-shrink tubing	–
3	N37749	-	Dual clamp tie	–
4	N56836	-	Spacer dual swivel	–
0.05	N74787		Electric cloth tape	–
LEVEL 2				
1	N632000652	-	Front-to-back cable (wire kit, 60 ft)	–
130	G5007995	-	Black tie wrap	–
0.05	N74787	-	Electric cloth tape	–
1	N93457-03	-	Solder sleeve (N8906891)	–
8	G5007996	-	Black tie wrap	–
3	N37749	-	Dual clamp tie	–
4	N56836	-	Spacer dual swivel	–
0.8m	N27548-18	-	Heat-shrink tubing	–

To order, please contact Prevost Parts by phone at 1-800-771-6682, by fax at 1-888-668-2555 or by email at prevostparts.commandes@volvo.com. Specify document number, quantity of parts required and shipping address.

DISPOSAL OF PARTS

REMOVED PARTS ARE:	DISCARDED *	RETAINED	* Dispose of the unused parts and the defective parts in accordance with local environmental standards in effect.
	Yes	–	

REVISION HISTORY

REV.	DATE	CHANGE DESCRIPTION	WRITTEN BY
NR	2019MR01	Initial release	Marc Rougeau

APPROVED BY:

PAGE 1
OF 27

CLIENT	ORDER	ROAD NUMBER		VIN (2NVY/4RKY...)		QTY
		FROM	TO	FROM	TO	
Austin - CMTA - Texas	LA17	5101	5107	S92J2H9775763	S92J3H9775769	7
Houston - Texas	L982	1581	1582	S92J5G9775514	S92J7G9775515	2
Houston - Texas	L982	1583	1583	S92J9G9775516	S92J9G9775516	1
Houston - Texas	L982	1584	1586	S92J2G9775518	S92J4G9775522	3
Houston - Texas	L982	1587	1587	S92J8G9775524	S92J8G9775524	1
Houston - Texas	L982	1588	1599	S92J1G9775526	S92J5G9775545	12
Mississauga Ontario	LA65	1770	1799	S92J8H9776254	S92J2H9776315	30
Niagara Falls Ontario - Metrolinx	LA98	1809	1810	S92J7J3751003	S92J9J3751004	2
St. Catharines Ontario - Metrolinx	LB06	1860	1862	S92J1J3751000	S92J5J3751002	3
York Regional Transit - Ontario	L964	1770	1774	S92J6G3750420	S92J3G3750424	5



WARNING

FOLLOW YOUR INTERNAL SAFETY PROCEDURES.

PROCEDURE

LEVEL 1 - BYPASS CABLE WIRE KIT INSTALLATION



NOTE

Level 1 involves the installation of a bypass cable wire kit in the engine compartment. If this solution fails, level 2 involves the installation of a one-piece cable wire kit from the throttle pedal to the engine ECM.

Read and understand Appendix 1. 2 and 3 at the end of this document before beginning.

1.1. Bypass cable wire kit N632000435 (see Figure 1).

**N632000435 ROUTING
WIRE KIT LAYOUT REPRESENTATION**

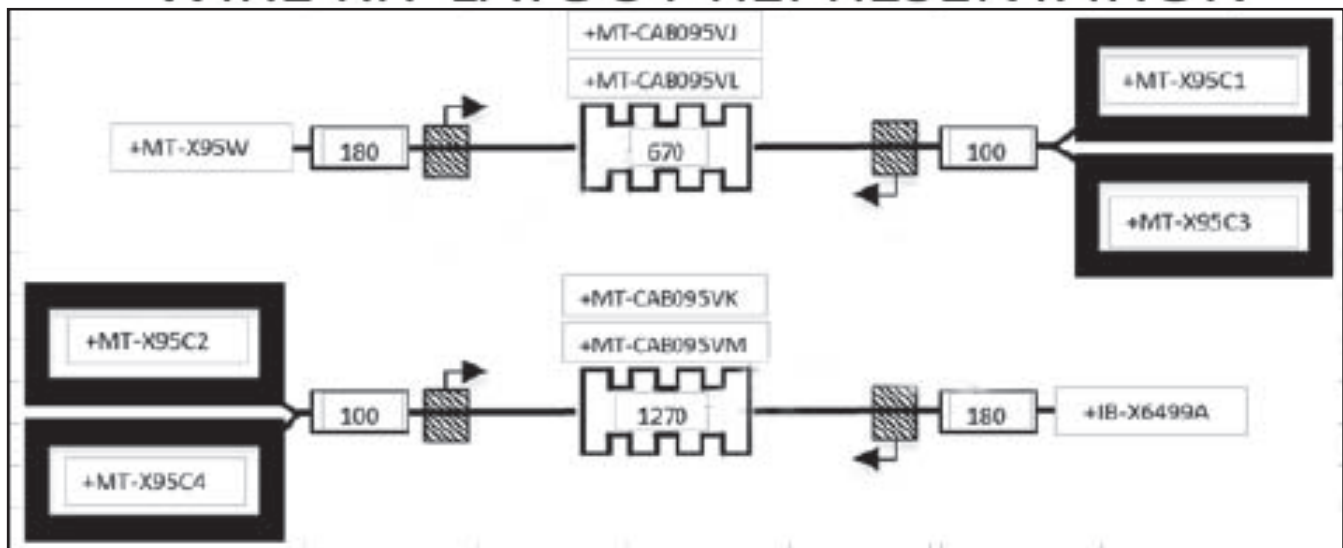

Figure 1 - Bypass Cable Wire Kit

1.2. Open the battery compartment access door, and ensure that the vehicle's power supply has been deactivated by turning off the battery cut-off switch (see Figure 2).

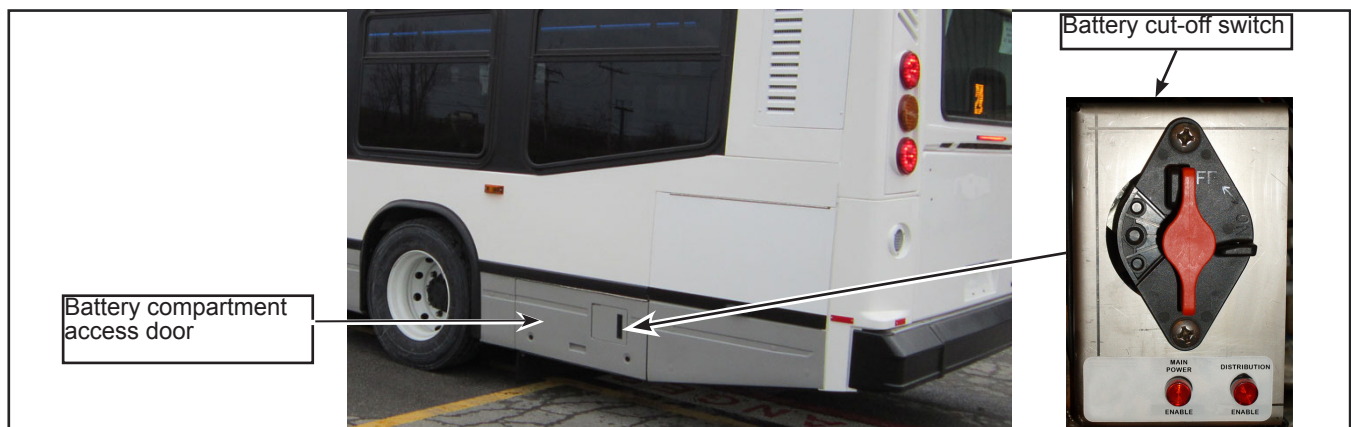

Figure 2 - Deactivate the Vehicle's Power Supply

- 1.3. Remove the two screws that secure the strain relief for the engine harness and disconnect the ECM connector (see Figure 3).

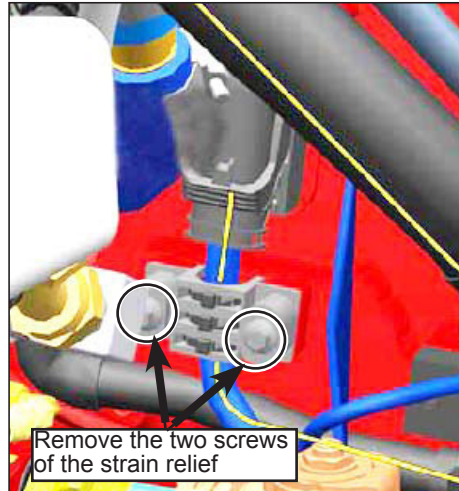

Figure 3 - Remove the Engine Harness Strain Relief and Disconnect

- 1.4. Raise the bus, open the ECM connector back shell, remove the red lock and extract the terminals and wires from the ECM connector for APS 1 and APS 2 using the Cummins 4918921 extraction tool. Avoid pulling on the wires before pushing the lip locks with the Cummins extraction tool. Insert the Cummins extraction tool avoiding a rotation movement. Pull on the wire once the wedge of the extraction tool has unlocked the pin (see Figure 4).

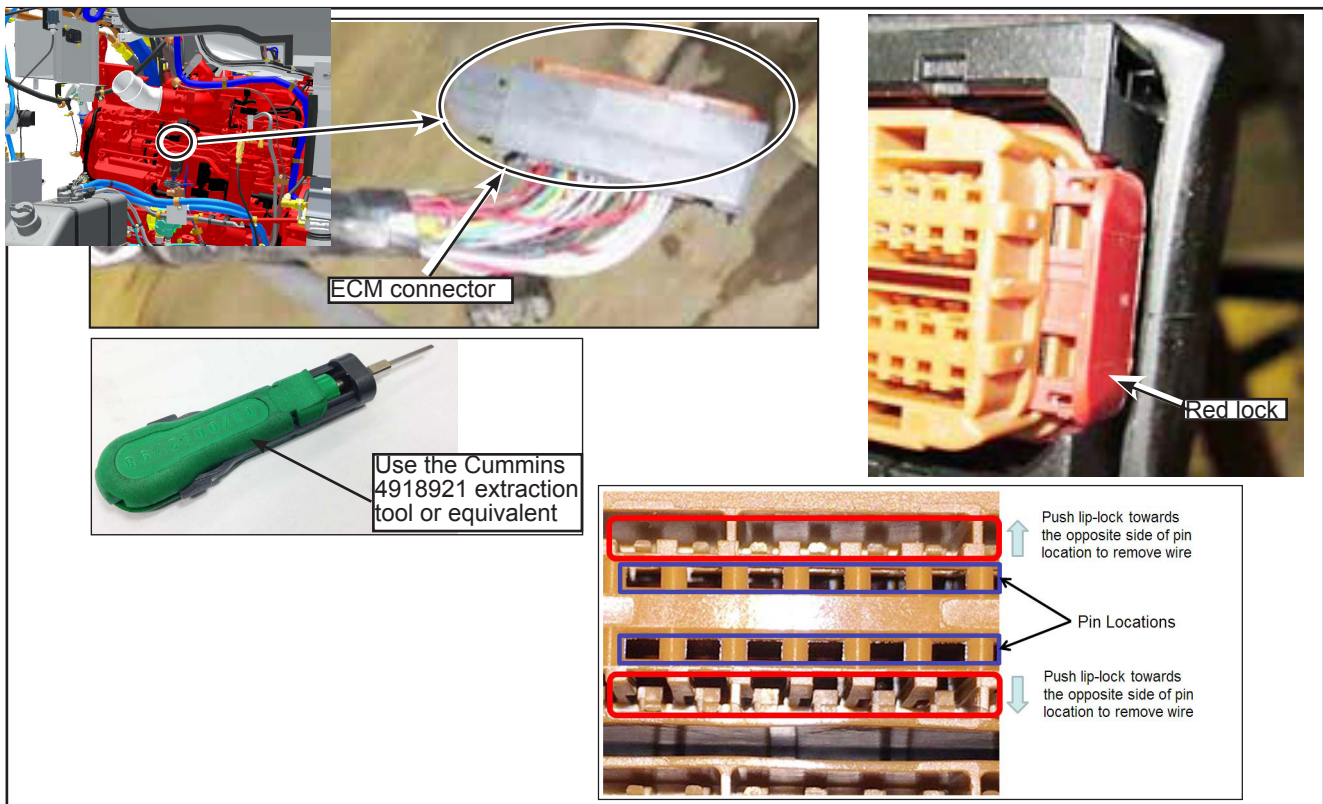

Figure 4 - Extract the Wires From the ECM Connector

- 1.5. Cut and tape back using N27548-18 all wires that were disconnected. For APS 1, use positions 9, 10 and 33. For APS 2, use positions 61 and 64. Install the five new wires of the bypass cable wire kit. Reassemble the ECM connector and lower the vehicle (see Figure 5).

1	2	3	4	5	6	7	8	9	10	11	12	13	14	15	16	17	18	19	20	21	22	23	24
	█		█					█	█	█						█	█		█				
25	26	27	28	29	30	31	32	33	34	35	36	37	38	39	40	41	42	43	44	45	46	47	48
				█	█	█		█			█								█				
49	50	51	52	53	54	55	56	57	58	59	60	61	62	63	64	65	66	67	68	69	70	71	72
						█	█					█			█				█				
73	74	75	76	77	78	79	80	81	82	83	84	85	86	87	88	89	90	91	92	93	94	95	96
	█				█		█																

+MT-X95W Terminal #	Wire AWG	Wire Color	Signal Description	Terminal Nova P/N	Terminal Delphi P/N	Cable Nova P/N	Cable Belden P/N	Cable Segment
9	20	Red	APS1 (TPS1) Supply	N68795	13627884	N83251	9364	1
10		Black	APS1 (TPS1) Signal					
33		White	APS1 (TPS1) Return					
64	20	Red	APS2 (TPS2) Signal	N68795	13627884	N83251	9364	2
61		Black	APS2 (TPS2) Return					

+MT -X95W

Red Pin 9

Black Pin 10

White Pin 33

APS 1

Red Pin 64

Black Pin 61

APS 2

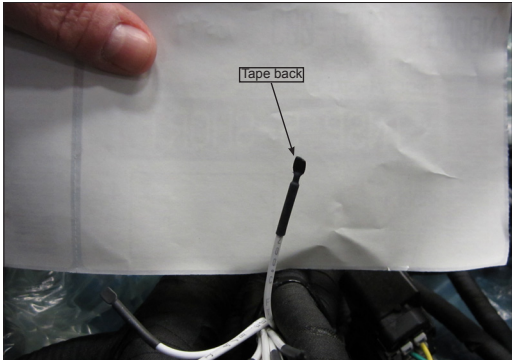

Figure 5 - Extract the Wires From the ECM Connector

- 1.6. Reconnect the ECM connector, secure the strain relief, fasten the bypass cable wire kit with three tie wraps (G5007995), and route the wire kit from the ECM connector (+MT-X95W) as shown below (see Figure 6).

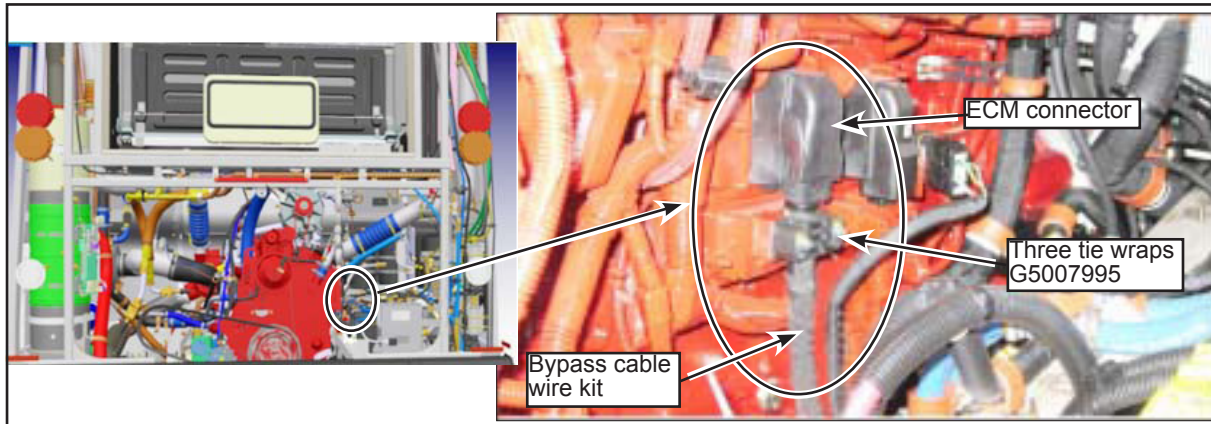

Figure 6 - Reconnect, Secure and Fasten the Bypass Cable Wire Kit

- 1.7. From the ECM connector, route the wire kit upwards and install the first N56836 dual swivel spacer with two G5007995 tie wraps (see Figure 7).

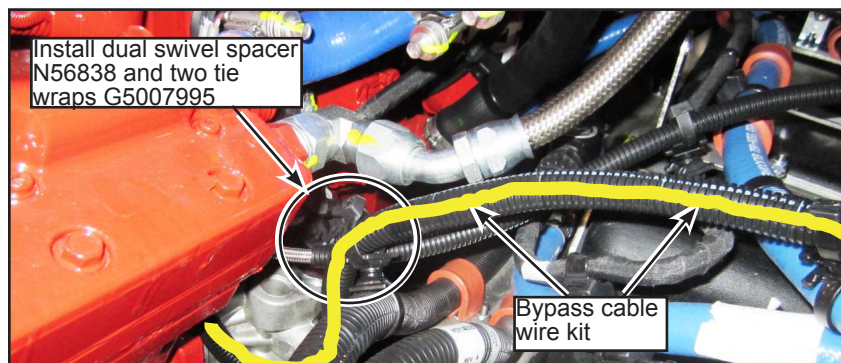

Figure 7 - Install the Dual Swivel Spacer with Two Tie Wraps

- 1.8. Install the second N56836 dual swivel spacer with two G5007995 tie wraps (see Figure 8).

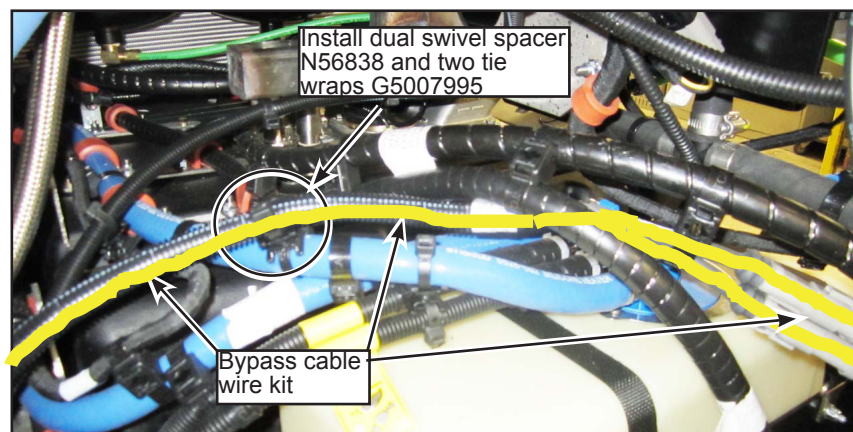

Figure 8 - Install the Dual Swivel Spacer with Two Tie Wraps

- 1.9. Install dual clamp ties N37749 on both sides of the bypass cable wire kit maintenance connectors (see Figure 9).

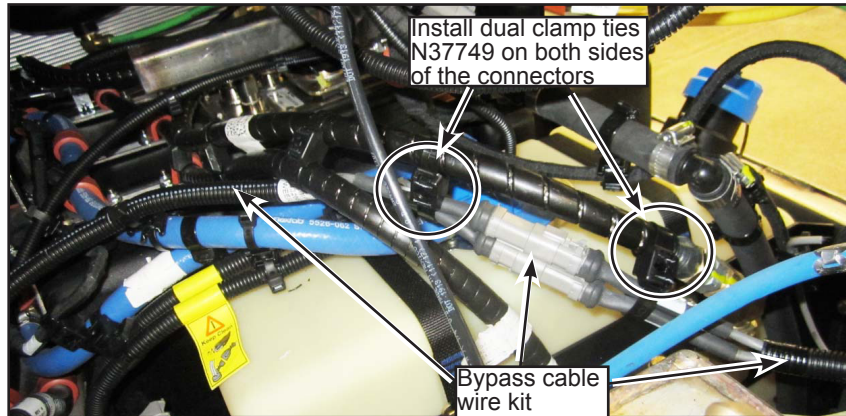

Figure 9 - Install Two Dual Clamp Ties

- 1.10. Route the bypass cable wire kit upwards (see Figure 10).

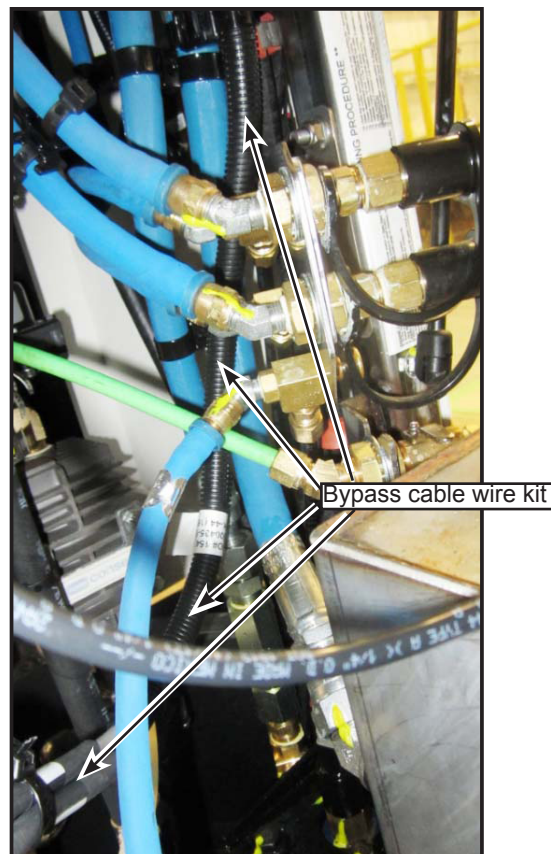

Figure 10 - Route the Bypass Cable Wire Kit Upwards

1.11. Install the dual clamp tie (see Figure 11).

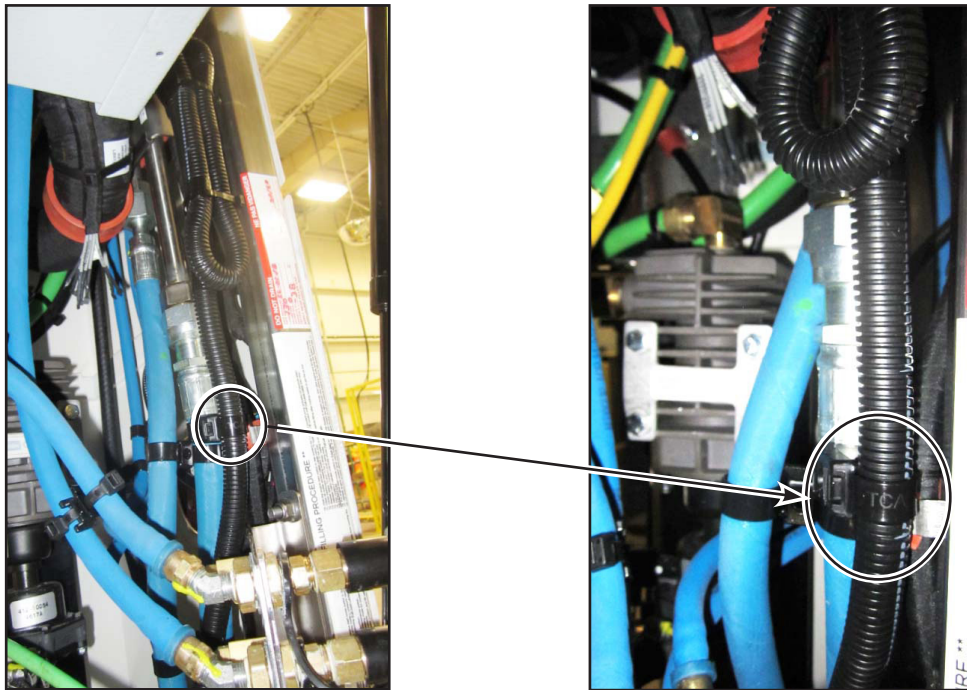

Figure 11 - Install the Dual Clamp Tie

1.12. Install two N56836 dual spacer swivels and four G5007995 tie wraps (see Figure 12).

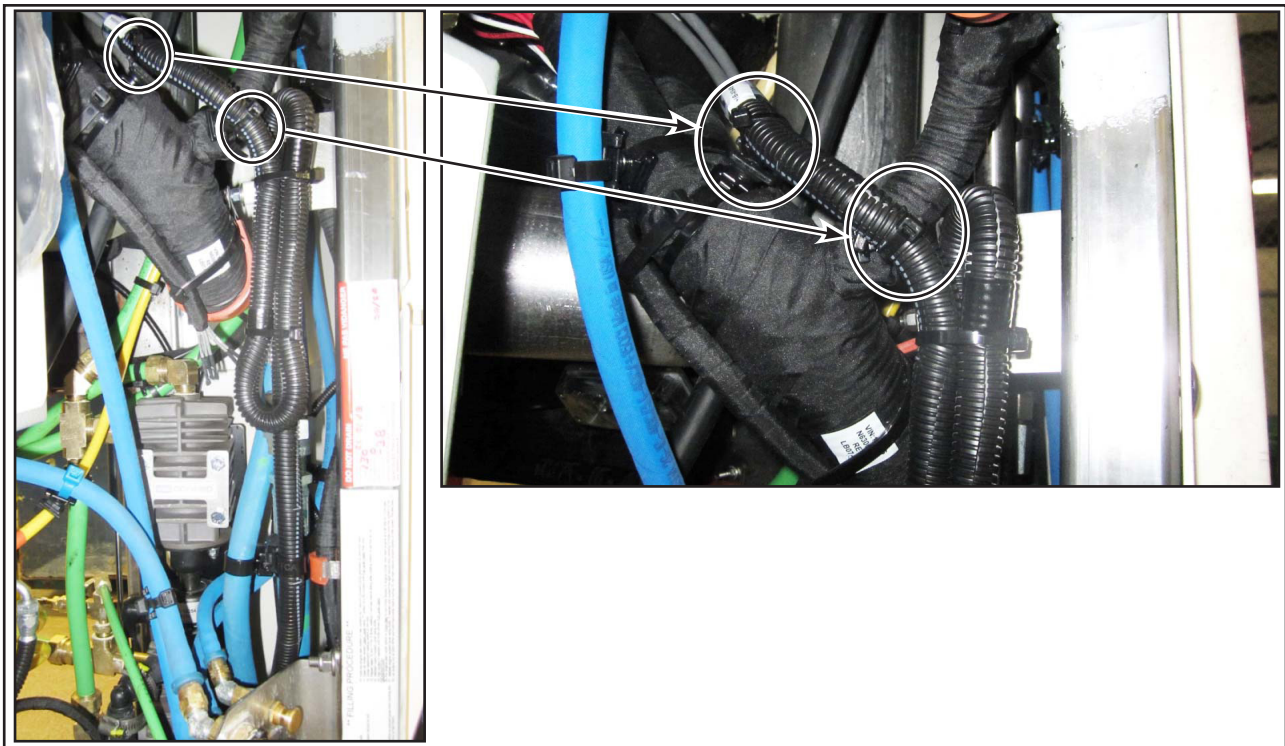

Figure 12 - Install Two Dual Spacer Swivels and Four Tie Wraps

- 1.13. Remove the +IB-X6499A bulkhead connector and extract the seven specified terminals for the APS 1 and APS 2 cables. Cut and tape back using N27548-18 all wires that were disconnected. For APS 1, use positions 88, 89, 90 and 91. For APS 2 use positions 84, 85 and 86. Install the seven wires from the bypass cable wire kit. Reassemble the bulkhead connector (see Figure 13).

+IB-X6499A Terminal #	Wire AWG	Wire Color	Signal Description	Terminal Nova P/N	Terminal Deutsch P/N	Cable Nova P/N	Cable Belden P/N	Cable Segment
91	18	Drain	APS1 (TPS1) Shield	G5900714	0462-201-16141	N28291	9365	1
90		Red	APS1 (TPS1) Supply					
89		Black	APS1 (TPS1) Signal					
88		White	APS1 (TPS1) Return					
84	18	Drain	APS2 (TPS2) Shield	G5900714	0462-201-16141	N28291	9365	2
86		Red	APS2 (TPS2) Signal					
85		Black	APS2 (TPS2) Return					

+IB -X6499A

Drain Pin 91
Red Pin 90
Black Pin 89
White Pin 88

APS 1

Red Pin 86
Black Pin 85
Drain Pin 84

APS 2

Tape back

Figure 13 - Install the Seven Wires From the Bypass Cable Wire Kit

- 1.14. Secure the excess length of the bypass cable wire kit onto the existing wire harness with two G5007996 tie wraps (see Figure 14).

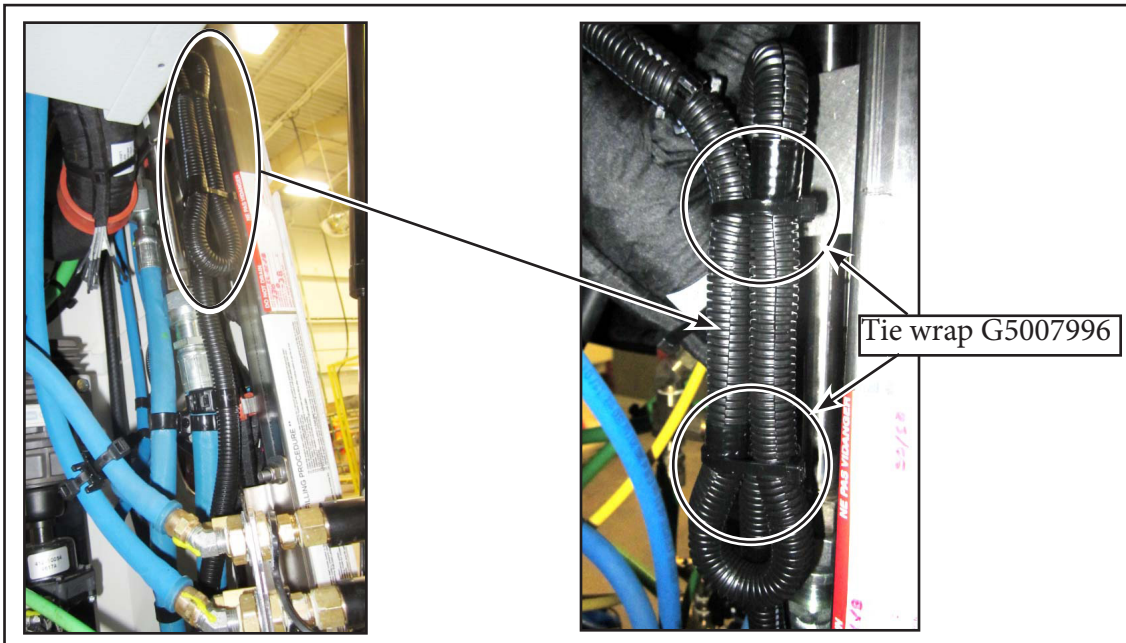

Figure 14 - Secure Excess Length of the Bypass Cable Wire Kit

- 1.15. Activate the vehicle's power supply.
1.16. Close the battery compartment access door.
1.17. Make sure that the engine starts properly.
1.18. Make sure that the throttle pedal operates properly.
1.19. Make sure that no active fault codes are present. If the Cummins 1242 fault codes return go to level 2 step 2.1.
1.20. Stop the engine.
1.21. Return the bus to service.

LEVEL 2 - FRONT TO BACK CABLE WIRE KIT INSTALLATION



NOTE

Level 1 involves the installation of a bypass cable wire kit in the engine compartment, if this solution fails, level 2 involves the installation of a one piece cable wire kit from the throttle pedal to the engine ECM.

- 2.1. Prepare to install the 60-ft front-to-back cable wire kit (N632000652) by performing step 1.2.
2.2. Remove the rear panel to access the Fire Suppression System (FSS) area (see Figure 15).

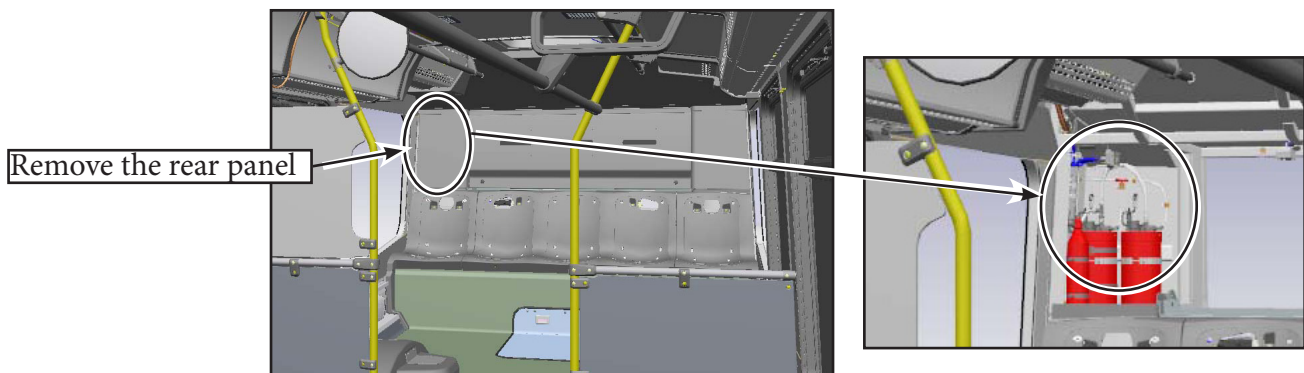

Figure 15 - Remove the Rear Panel

- 2.3. Drill two 12 mm holes to the left of the +IB-X6499A bulkhead connector located in the lower part of the FSS area. Align the first hole vertically with the center of the connector and 63 mm to the left. Align the second hole vertically with the center of the connector and 133 mm to the left (see Figure 16).

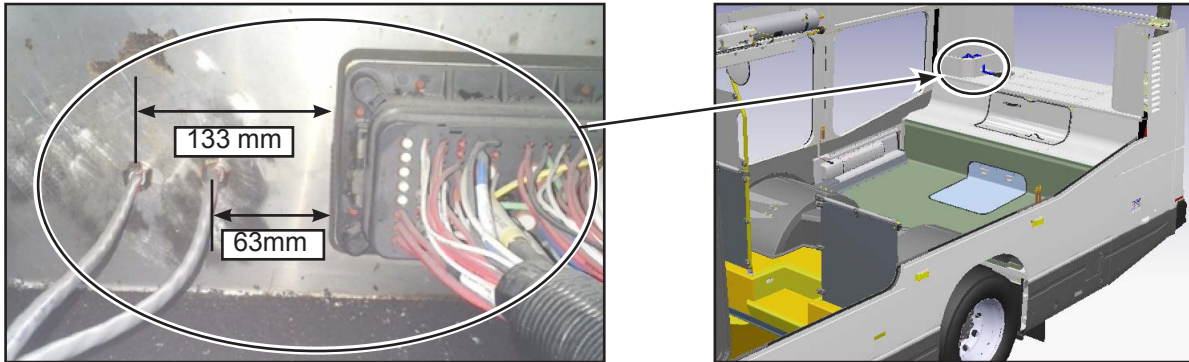

Figure 16 - Drill Two Holes for Later Installation of Cable Glands

- 2.4. Remove the following panels for access prior to routing the front-to-back wire kit: lateral console panel, foot guard panel, front console panel, driver partition panel, and all streetside baselight panels. Open the ITS compartment (see Figure 17).

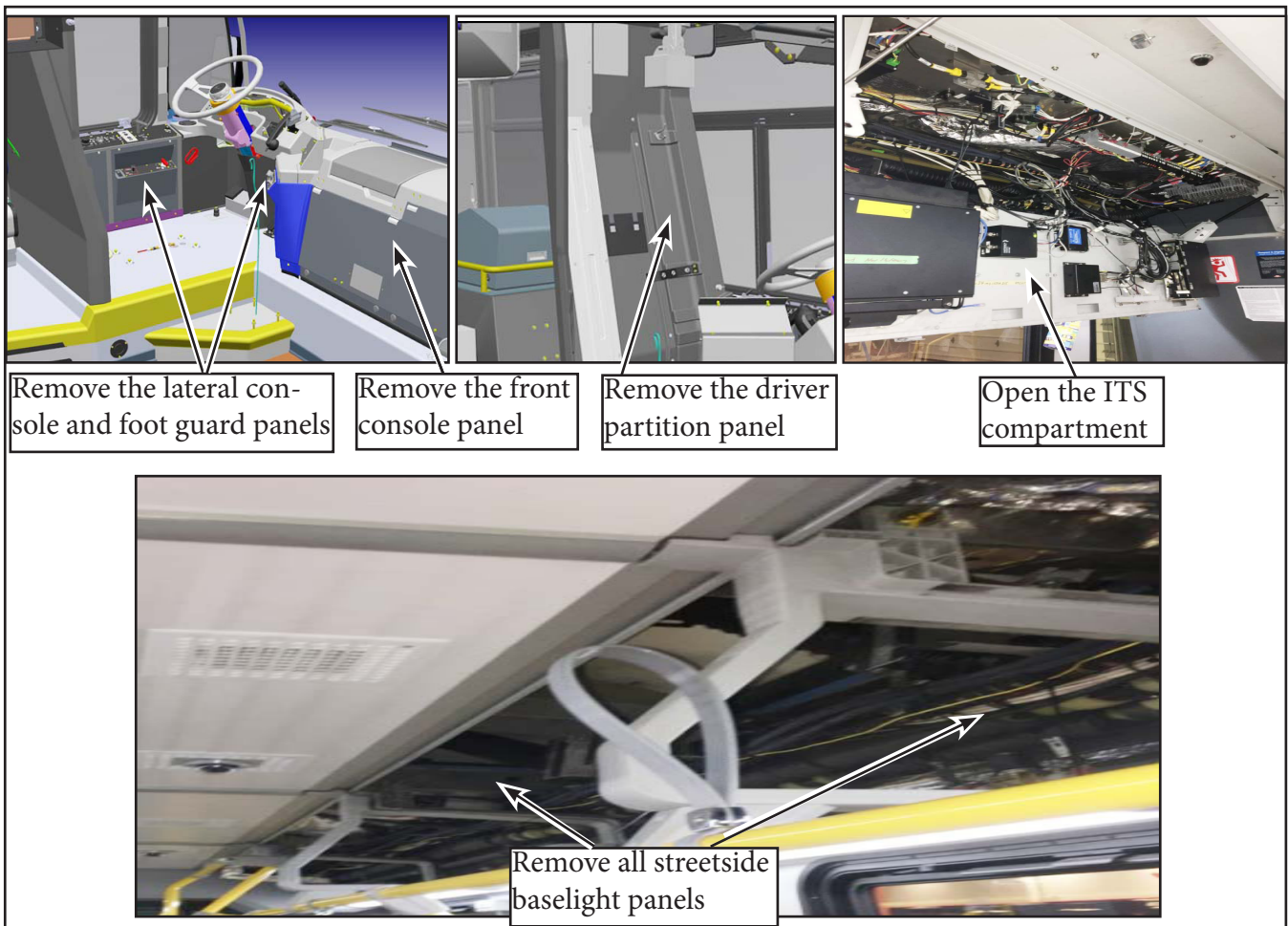

Figure 17 - Remove Panels

- 2.5. Start the front to back cable routing at the throttle pedal connectors and route under the dash towards the throttle pedal (see Figure 18).

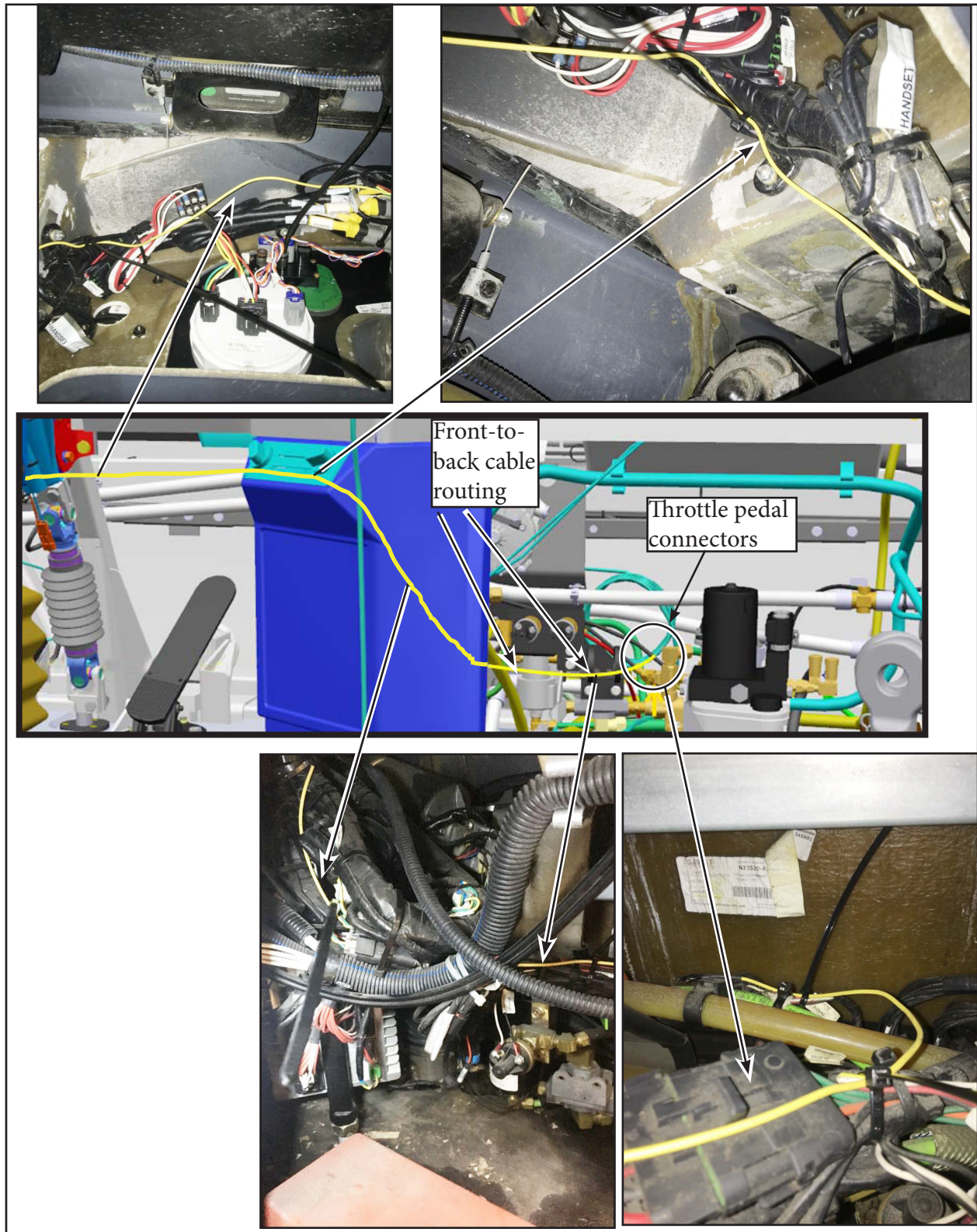

Figure 18 - Front-to-Back Cable Routing

- 2.6. Cut the original throttle pedal connectors on the main harness side and tape back the original breakout wires. Connect the throttle pedal connectors to the front to back cable connectors (+DH-X01D and +DH-X01E) and secure with tie wraps from the throttle pedal connectors to the ITS compartment (see Figure 19).

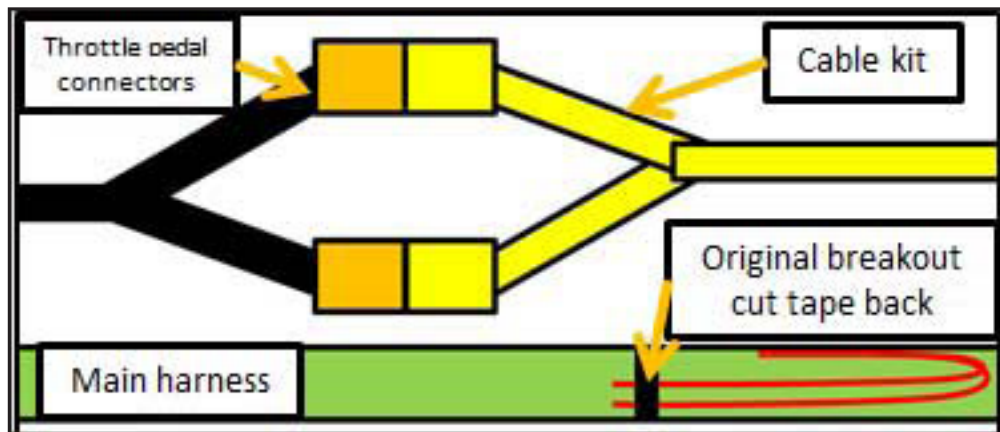

Figure 19 - Front to Back Cable Connection

- 2.7. Continue the front to back cable routing and tie wrapping through the lateral console and driver partition (see Figure 20).

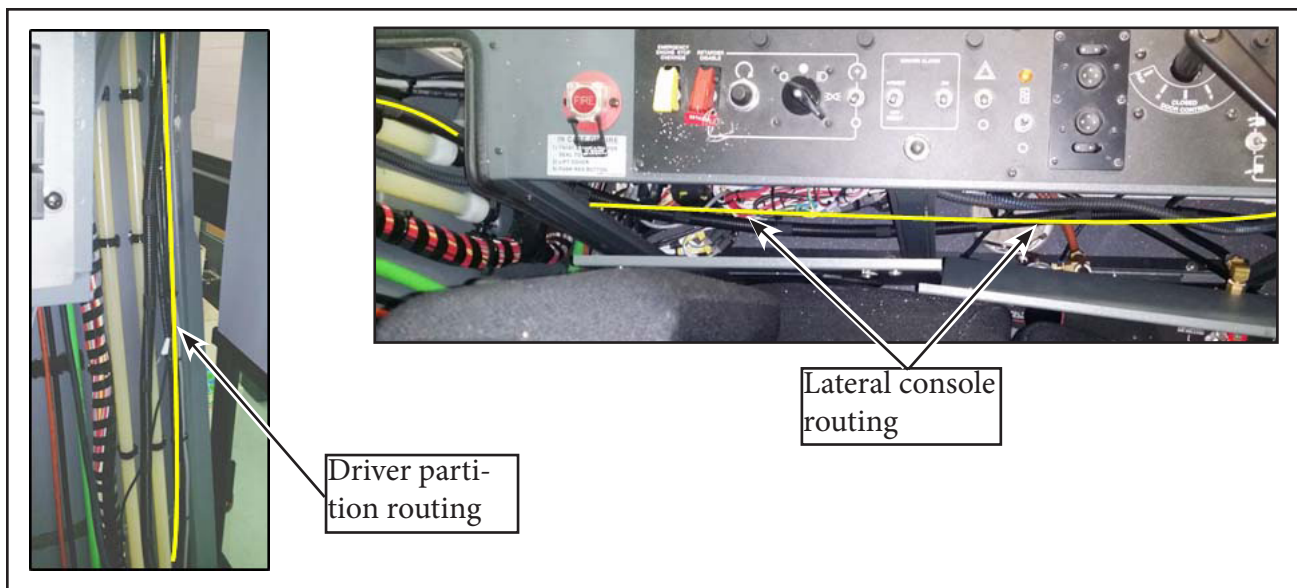

Figure 20 - Front to Back Cable Routing in Driver Area

2.8. Continue routing and tie wrapping the front to back cable through the ITS compartment (see Figure 21).

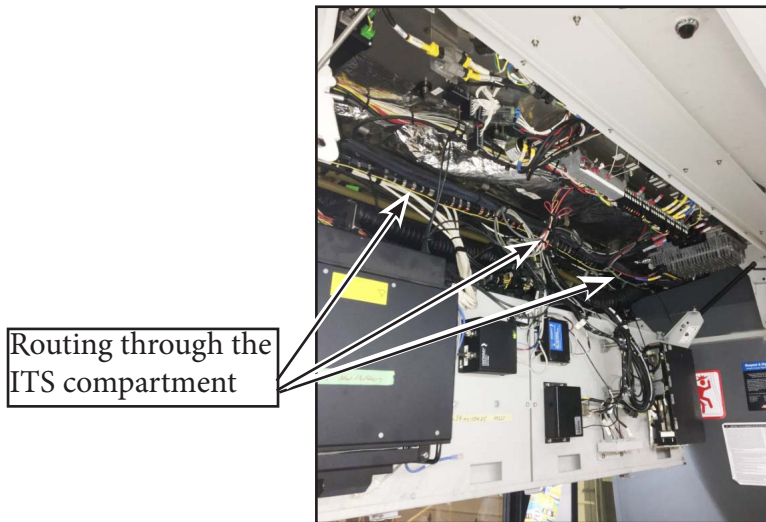

Figure 21 - Front to Back Cable Routing in the ITS Panel Area

2.9. Continue routing and tie wrapping the front to back cable through the streetside baselights (see Figure 22).



Figure 22 - Front to Back Cable Routing in the Streetside Baselights

- 2.10. Continue routing and tie wrapping the front to back cable through the front bulkhead towards the EGS (see Figure 23).

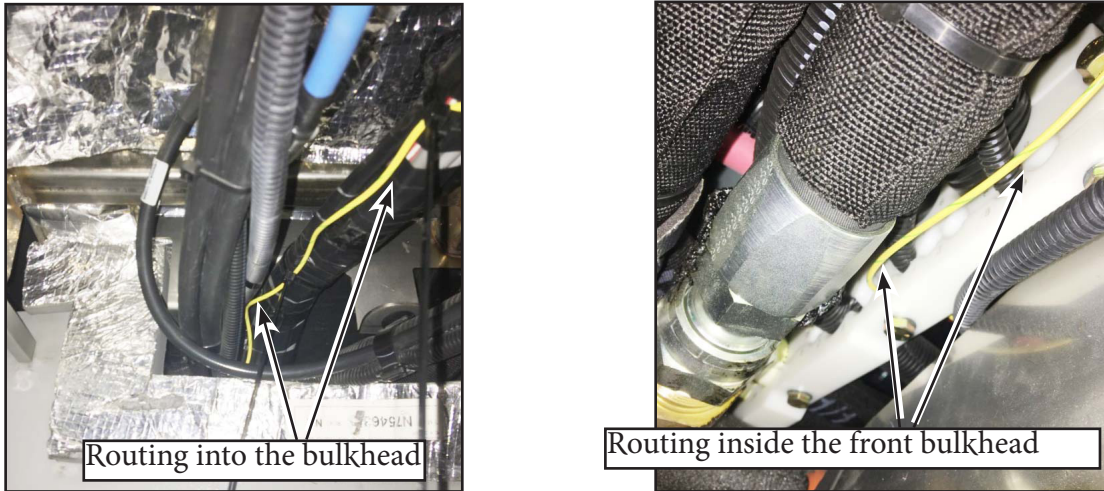

Figure 23 - Front-to-Back Cable Routing in the Front Bulkhead Area

- 2.11. Continue routing the front to back cable through the EGS, secure it to the existing cables with tie wraps and continue routing through the rear bulkhead (see Figure 24).



Figure 24 - Front-to-Back Cable Routing in the EGS

- 2.12. Continue routing and tie-wrapping the front-to-back cable through the rear bulkhead towards the next curbside baselight (see Figure 25).

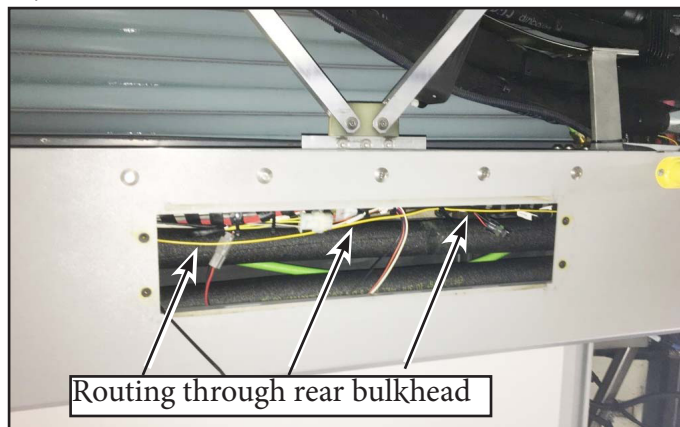

Figure 25 - Front-to-Back Cable Routing in the Rear Bulkhead Area

- 2.13. Continue routing and tie wrapping the front to back cable through the rear bulkhead and through the curbside baselights towards the rear of the bus (see Figure 26).

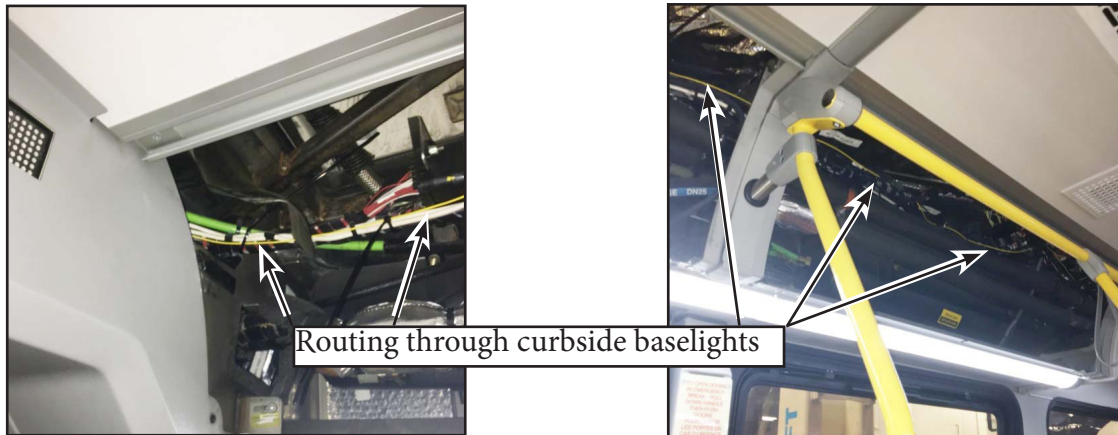

Figure 26 - Front to Back Cable Routing in the Rear Curbside Baselights

- 2.14. Continue routing and tie wrapping the front to back cable behind the Fire Suppression System (FSS). Insert the APS cable segments with the cable glands separately into the two holes previously drilled in step 2.3. Torque the cable glands to 3-4.5 N•m (see Figure 27).

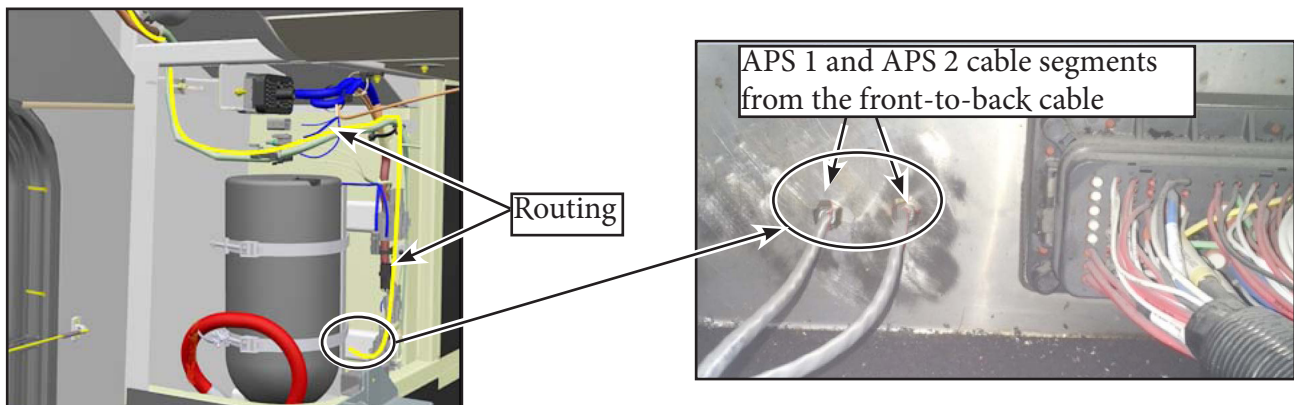

Figure 27 - Front-to-Back Cable Routing in the +IB-X6499A Area (FSS Side)

- 2.15. Rejoin the two APS cable segments within the convoluted tubing provided with the front to back cable wire kit. Continue routing and tie-wrapping the front-to-back cable along harness 64 inside the engine compartment (see Figure 28).

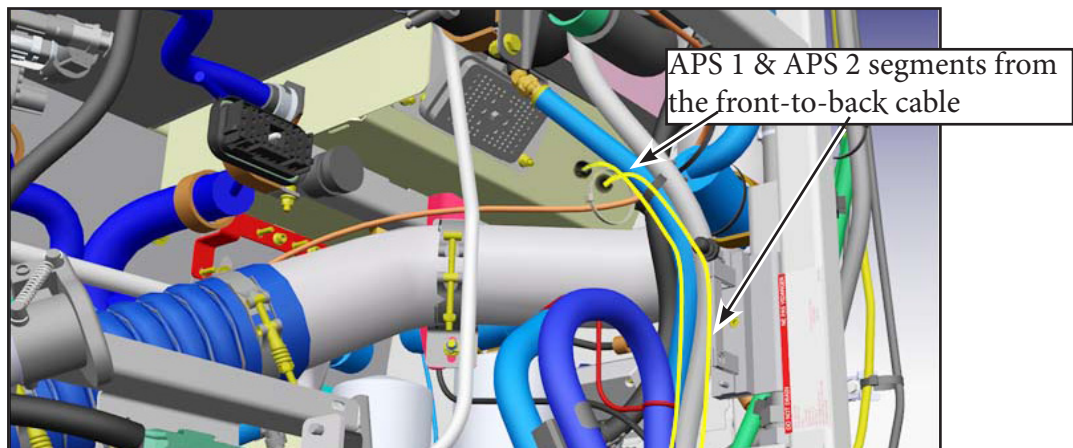

Figure 28 - Front-to-Back Cable Routing in the +IB-X6499A Area (Engine Compartment)

- 2.16. Raise the bus and continue routing and tie-wrapping the front to back cable over the same routing path previously used for the bypass cable in level 1 (see Figure 29).

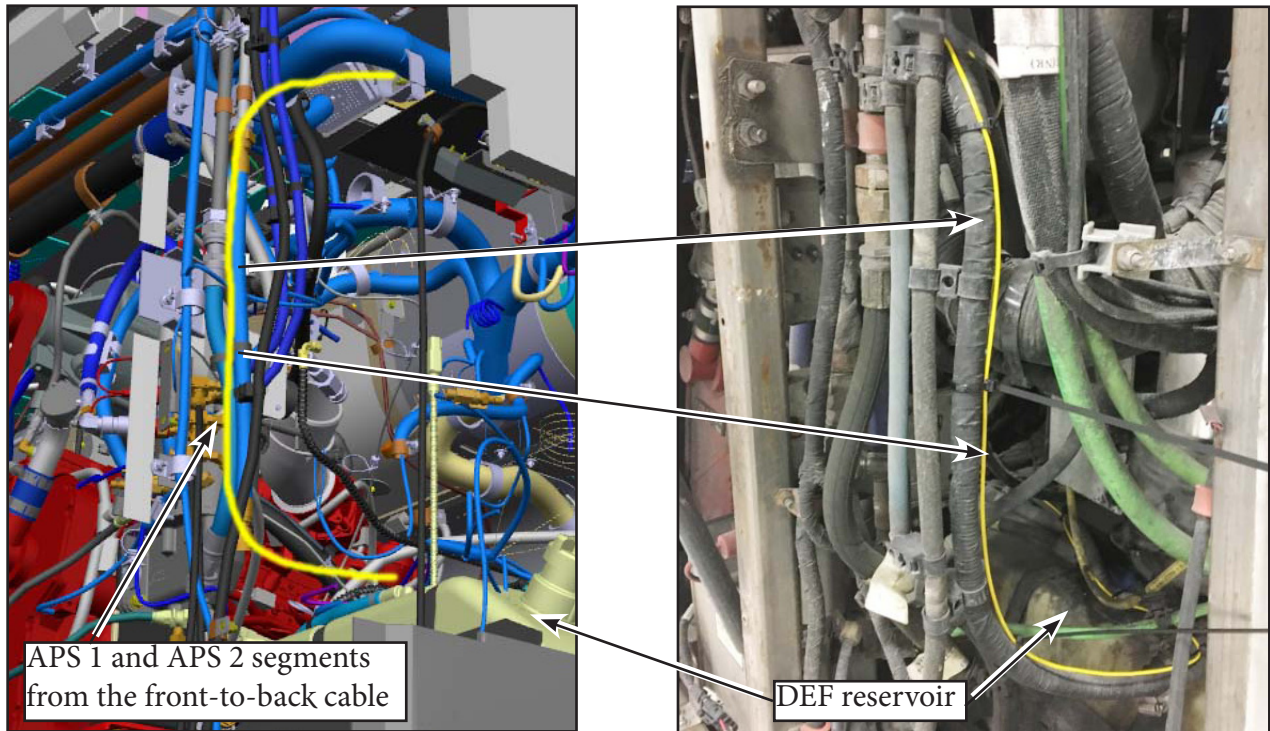

Figure 29 - Front-to-Back Cable Routing in the Hydraulic Oil Tank Area

- 2.17. Continue routing and tie-wrapping the front to back cable down over the DEF reservoir towards the ECM connector (see Figure 30).

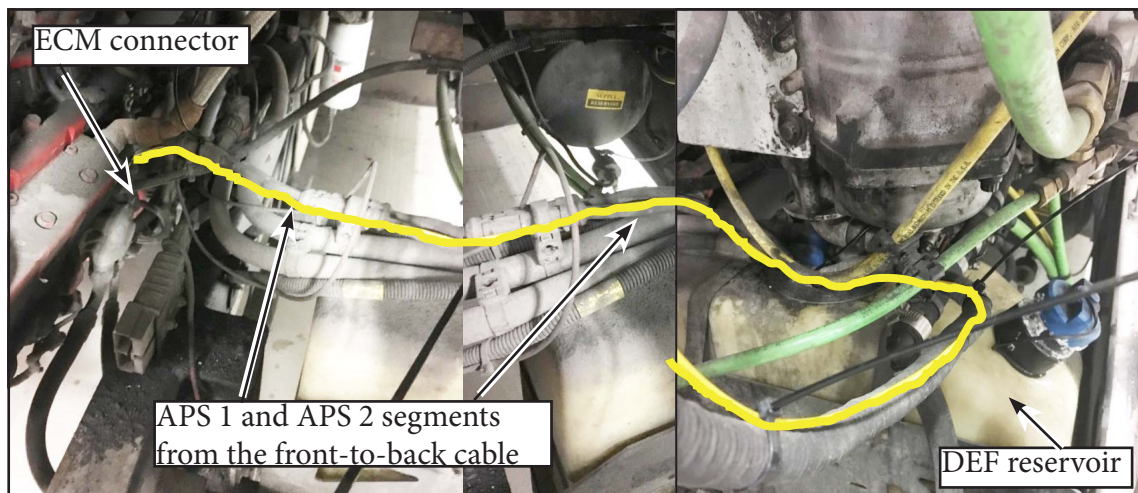

Figure 30 - Front-to-Back Cable Routing to the ECM Connector

- 2.18. Remove the two ECM connector strain relief screws, disconnect the ground splice connector and cut the 3 cable ties (see Figure 31).

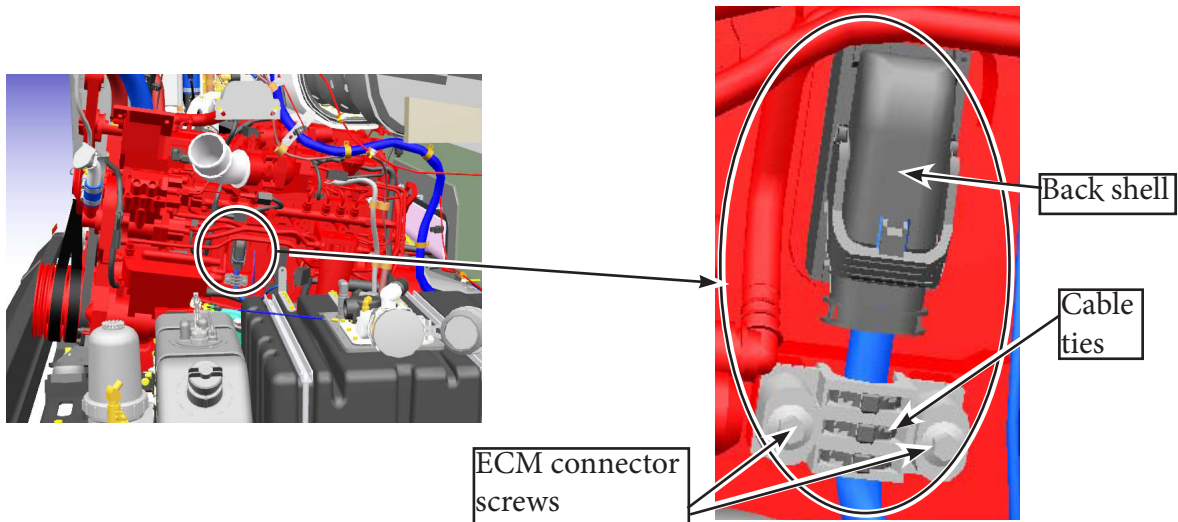

Figure 31 - Disassemble the ECM Connector

- 2.19. Remove the ECM connector back shell and route the front-to-back cable towards the connector (see Figure 32).

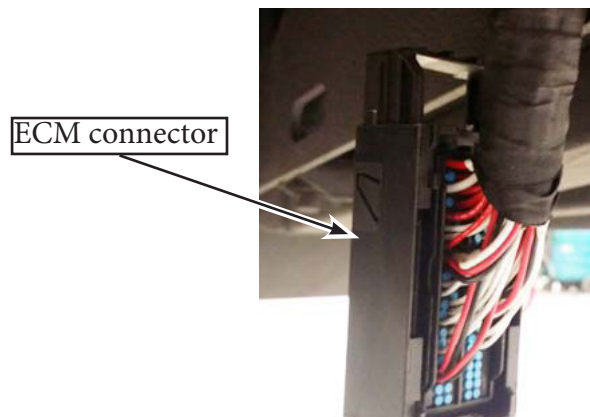

Figure 32 - Front-to-Back Cable Routing to the ECM Connector

- 2.20. Remove the electric cloth tape covering the wires entering the ECM connector. Disconnect wires at positions 9, 10, 33, 61 and 64 from the previously-installed bypass cable kit, then cut and tape back (see Figure 33).

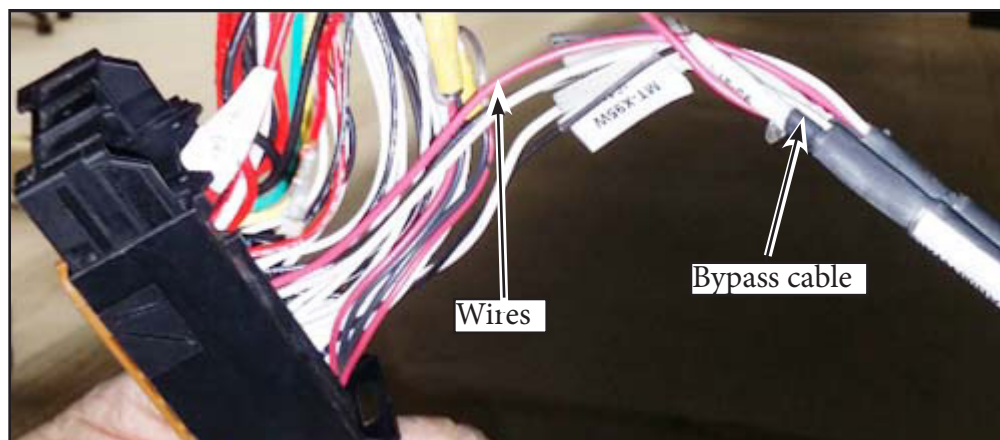

Figure 33 - Disconnect the Bypass Cable Terminals From the ECM Connector

2.21. Slide in the two heat shrink tubing segments provided with the front to back cable wire kit over the end of each APS cable segment. Use a heat gun to shrink the tubing at the extremity of each APS cable segment. Insert the terminals from the front-to-back cable into the correct ECM connector positions. Use the wire color and wire label as identification. For APS 1, use positions 9, 10 and 33. For APS 2, use positions 61 and 64 to install five of the six new wires of the front-to-back cable (see Figure 34).

1	2	3	4	5	6	7	8	9	10	11	12	13	14	15	16	17	18	19	20	21	22	23	24
			X														X						
25	26	27	28	29	30	31	32	33	34	35	36	37	38	39	40	41	42	43	44	45	46	47	48
49	50	51	52	53	54	55	56	57	58	59	60	61	62	63	64	65	66	67	68	69	70	71	72
73	74	75	76	77	78	79	80	81	82	83	84	85	86	87	88	89	90	91	92	93	94	95	96
							X																

ECM CONNECTOR SIDE								
+MT-X95W Terminal #	Wire AWG	Wire Color	Signal Description	Terminal Nova P/N	Terminal Delphi P/N	Cable Nova P/N	Cable Belden P/N	Cable Segment
9	20	Red	APS1 Supply	N68795	13627884	N83251	9364	1
10		White	APS1 Signal					
33		Black	APS1 Return					
8	20	Red	APS2 Supply	N68795	13627884	N83251	9364	2
64		White	APS2 Signal					
61		Black	APS2 Return					

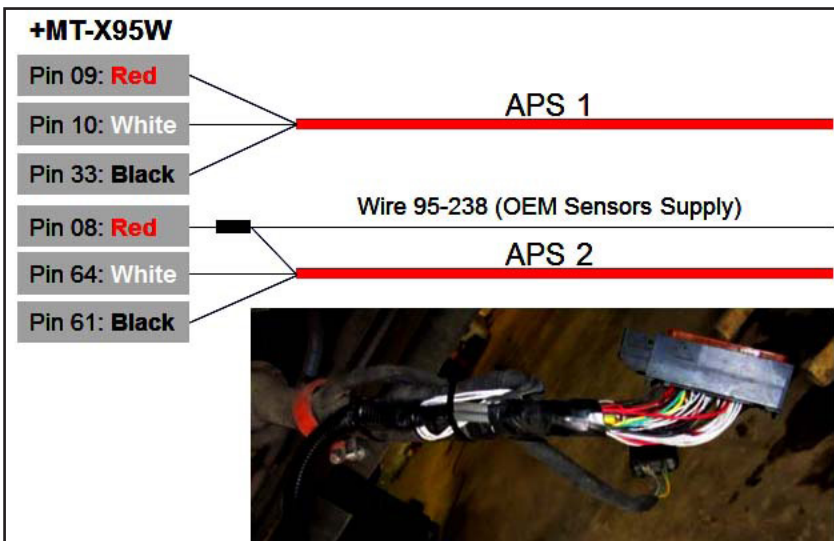

Figure 34 - Positions to be Used for APS 1 and APS 2 Cable Segment Connections

- 2.22. Locate the wire 95-238 (5V OEM sensor supply red wire) at position 8 of the ECM connector, measure 5 inches and cut the wire. Remove 1/2 inch of insulation at both ends of wire 95-238 and at the end of the remaining red wire of the front-to-back cable and insulation on both the wire from position 8 and the remaining wire of the new wire kit. Install a solder sleeve (N93457-03) over the 3 wires and heat evenly until the solder penetrates into the wires (see Figure 35).

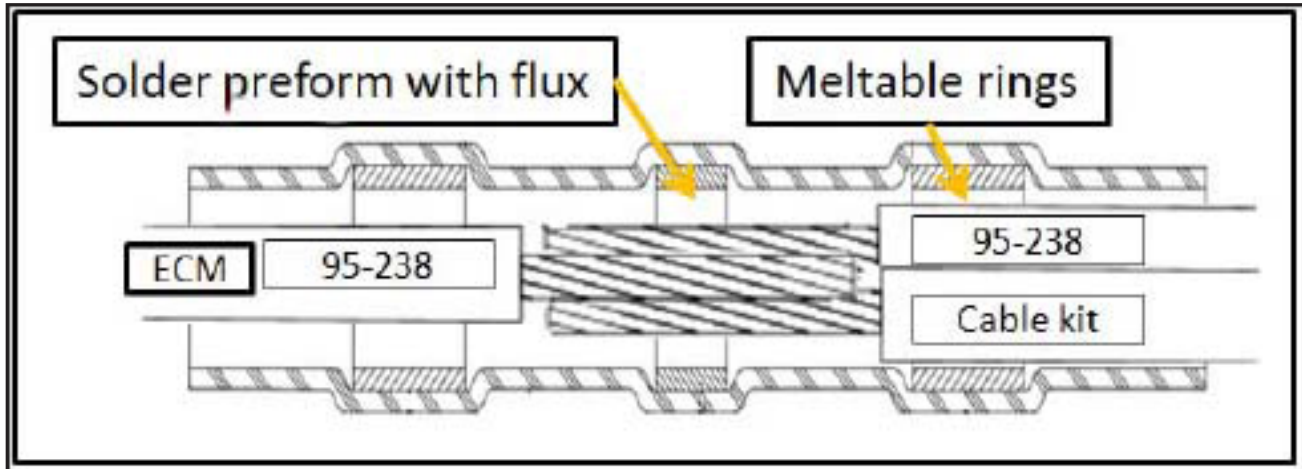

Figure 35 - Install a Solder Sleeve for 5V OEM Sensor Supply Splicing

- 2.23. Apply electric cloth tape over the front-to-back cable and the exposed wiring at the ECM connector. Install the ECM connector back shell and the 3 cable ties. Connect the ECM connector to the ECM and install both strain relief screws. Reconnect any splice connector disconnected earlier (see Figure 36).

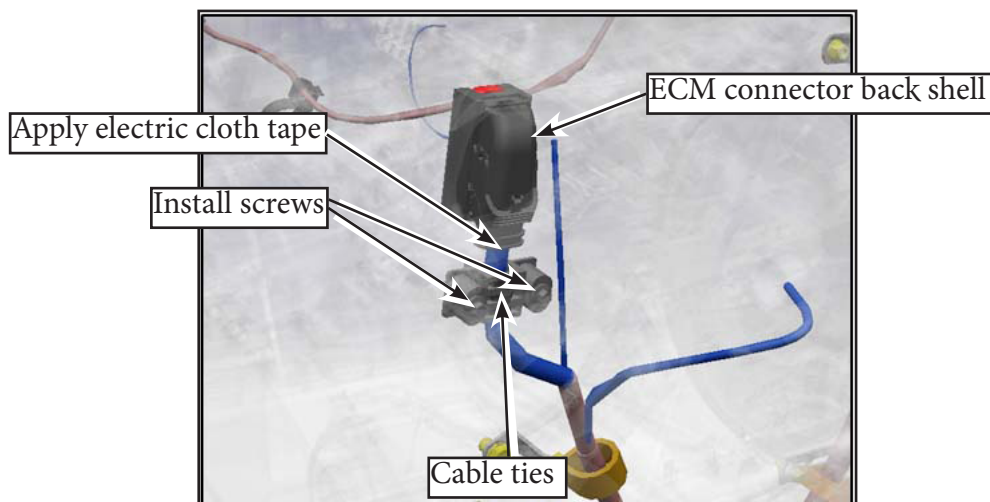

Figure 36 - Reassemble the ECM Connector

- 2.24. Activate the vehicle's power supply.
- 2.25. Close the battery compartment access door.
- 2.26. Make sure that the engine starts properly.
- 2.27. Make sure that the throttle pedal operates properly. .
- 2.28. Make sure that no active fault codes are present.
- 2.29. Stop the engine.
- 2.30. Close all panels (rear panel, baselight panels, lateral console panel, front console panel, foot guard panel, and driver partition panel) and ITS compartment.
- 2.31. Return the bus to service. ❖

APPENDIX 1 - GENERAL TROUBLESHOOTING PROCEDURE (ENGINE FAULT CODE 1242)

This troubleshooting procedure applies to Cummins Engine Fault Code 1242 (Accelerator Pedal or Lever Position Sensor 1 - Data Erratic, Intermittent, or Incorrect).

There are several Fault Codes (FC) referring to Throttle Pedal Sensor issues. Whenever other TPS FCs are logged along with 1242 FC, these other FCs should be troubleshot first. These other FCs correspond to TPS wiring faults, such as open- and short-circuit, and are also likely to generate a 1242 FC. Detailed information about these other TPS FCs can be found in the Cummins INSITE documentation.

Systematically proceed according to the following troubleshooting steps to identify what is causing the engine 1242 FC and to eventually eliminate this FC.

1. First connect to the Engine Control Module (ECM) with the Cummins INSITE diagnostic software tool to check for the presence of FCs (verify if any 1242 fault code has been recorded in the ECM log). If one or more 1242 FCs were logged, create a work order and save the ECM image.
 2. Perform wiggle/pull tests on the TPS cables running in the bus cabin (check all interior locations) and in the engine compartment to see if any FC occurs. Also carefully check every TPS cable connector along the routing path (from throttle pedal to ECM) for any missing/damaged seal or terminal corrosion.
 - Remain logged onto Cummins INSITE and try to generate the 1242 FC or any other TPS FC.
 - Correct/repair if any wiring and/or terminal integrity issues are found. Then test drive the bus and return it to service if the 1242 FC does not return.
 3. Inspect to check if DCP-504300 was properly applied (see Appendix 2 for DCP-504300 instructions).
 - Production Change Order DCP-504300 was applicable to a large number of diesel buses built after the BS3626E service document release (from lot L998 to lot LB32) but its application must be confirmed.
 - If DCP-504300 was not properly implemented, relocate the two TPS cable connectors further away from the alternator by following the instructions provided.
 4. Test the throttle pedal operation (see Appendix 3 for the throttle pedal testing procedure).
 - If the throttle pedal test fails with the 1242 FC, then replace the throttle pedal with a new or spare unit (previously tested / known-good unit), test drive the bus and finally return it to service if the 1242 FC does not return.
 - Otherwise, if all of the above troubleshooting steps have successfully passed and the 1242 FC still returns, systematically proceed to check each of the following scenarios.
- A. Check whether the original campaign BS3626E has been performed on the bus.
- If YES, double-check that the BYPASS CABLE wire kit (Nova p/n N632000435) has been installed according to BS3626E instructions and thoroughly inspect it for moisture intrusion (missing/leaking connector seal or wire entry seal), connector damage or terminal corrosion.
 - If YES, the BYPASS CABLE wire kit has been on bus for a long period and 1242 FC still occurs, install a new BYPASS CABLE wire kit and route it according to the LEVEL 1 INSTRUCTIONS specified in this Information Letter.
 - If NO, install the BYPASS CABLE wire kit and route it according to the LEVEL 1 INSTRUCTIONS specified in this Information Letter.
 - Test-drive the bus and return it to service if passing.
 - If the 1242 FC still returns in service, proceed to check scenario B.

- B. Check whether the BS3626E BYPASS CABLE wire kit has been installed AND routed according to the LEVEL 1 INSTRUCTIONS specified in this Information Letter.
- If YES, double-check the BYPASS CABLE wire kit installation and thoroughly inspect it for moisture intrusion (missing/leaking connector seal or wire entry seal), connector damage or terminal corrosion.
 - Test drive the bus and return it to service if passing.
 - If the 1242 FC still returns in service, proceed to check scenario C.
- C. If, and only if, all of the above troubleshooting, testing (all tests pass and no 1242 FC can be generated) and BYPASS CABLE wire kit LEVEL 1 installation work have been performed but 1242 FC still returns, proceed to the following ultimate troubleshooting step and action.
- Install a FRONT-TO-BACK CABLE wire kit (continuous TPS cable running from the throttle pedal to the engine ECM) and route it according to the LEVEL 2 INSTRUCTIONS specified in this Information Letter.
 - Use the Nova Bus p/n N632000**594** FRONT-TO-BACK CABLE wire kit for installation on a **40**-ft bus.
 - Use the Nova Bus p/n N632000**652** FRONT-TO-BACK CABLE wire kit for installation on a **60**-ft bus.

APPENDIX 2 - DCP-504300 PRODUCTION CHANGE ORDER

NOVABUS

DCP-504300

FUEL PEDAL – EMI interference close to Alternator

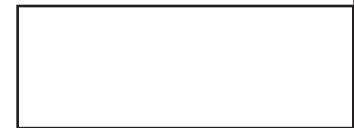

DCP-504300
Operation:C0095D



Instructions Spéciales/ Special Instruction		
#	Action	Commentaires / Comments
	Déplacer	<p>Les x2 connecteurs (MT-X9564E) sont situés trop près de l'alternateur, ce qui altère le signal d'accélération de la pédale à carburant (EMI). Déplacer les connecteurs de la localisation A à la localisation B.</p> <p>The 2 connectors (MT-X9564E) are located too close to the alternator and create EMI to the fuel pedal signal. Need to move connector from location A to location B (see picture)</p>

APPENDIX 3 - THROTTLE PEDAL TESTING PROCEDURE (ENGINE FAULT CODE 1242)

This troubleshooting procedure applies to Cummins Engine Fault Code 1242 (Accelerator Pedal or Lever Position Sensor 1 - Data Erratic, Intermittent, or Incorrect).

Perform the following throttle pedal tests with the bus ignition on, the engine stopped, and finally with the engine running.

- Check several throttle pedal angular positions.
- Hold throttle pedal for 30 seconds.
- Try to replicate several scenarios that might occur in service.

When the engine is running, the throttle can be disabled by activating rear doors to engage throttle interlock. This will prevent running the engine at full throttle in neutral for 30 seconds.

Conditions Required to Trigger the Cummins 1242 Fault Code

The Engine Control Module (ECM) detects that readings from Accelerator Position Sensor APS 1 and APS 2 differ by more than 2%.

Note: Even though the APS 1 and APS 2 throttle pedal sensors are both powered by regulated 5 V voltage sources supplied by the ECM, the APS 1 output signal range is twice that one of APS 2. This is why a full throttle condition corresponds to an APS 1 reading of 4.25 V and to APS 2 reading of 2.13 V in the following figures.

Throttle Pedal Testing Procedure

After the following two preliminary steps, proceed with the test sequence presented on the next page while applying the specified pass/fail criteria and referring to the key observations detailed.

- Log onto INSITE to test the throttle pedal.
- Pull up APS 1 & APS 2 data readings from the INSITE log.

The screenshot displays the INSITE software interface. On the left sidebar, the 'Data Monitor/Logger' icon is highlighted with a red box labeled '1'. In the main parameter list, 'All Parameters' is selected and highlighted with a red box labeled '2'. In the parameter details pane, 'Active Accelerator Type' is highlighted with a red box labeled '3'. Below the parameter list, a table shows fault codes, with fault code 1242 highlighted in red.

Parameter	Value	Units
Accelerator Interlock State	Locked	
Accelerator Pedal Or Lever Position Sensor 2 Signal Voltage	0.50	V
Accelerator Pedal Or Lever Position Sensor 2 Supply Voltage	5.02	V
Accelerator Pedal or Lever Position Sensor Signal Voltage	1.06	V
Accelerator Pedal or Lever Position Sensor Supply Voltage	5.02	V
Active Accelerator Type	Dual-Analog	
Aftertreatment Diesel Exhaust Fluid Dosing Unit Heater State	Initializing	
Aftertreatment Diesel Exhaust Fluid Dosing Unit State	Initializing	
Aftertreatment Diesel Exhaust Fluid Dosing Valve Commanded Position	Closed	
Aftertreatment Diesel Exhaust Fluid Lamp Status	Off	
Aftertreatment Diesel Exhaust Fluid Line Heater 1 Status	Off	

Fault Code	Status	Count	Lamp	Description	PID	SID	J1587 FMI	J1939 FMI	SPN
CM2350A	Inactive	21	Red	Accelerator Pedal or Lever Position Sensor 1 - Data Erratic, Intermittent, or Incorrect	91	2	2		91

Figure A3.1. Log onto INSITE to Test the Throttle Pedal

Throttle Pedal Test Pass/Fail Criteria

- APS 1 and APS 2 signal readings should vary smoothly according to the throttle pedal angular position.
- APS 1 and APS 2 signal readings should be stable when the throttle pedal position does not change.
- The APS 1 signal reading should always be twice as much as the APS 2 signal reading.

Throttle Pedal Test Sequence

1. Test the bus with engine OFF.
 - Exercise the throttle pedal.
 - Observe the INSITE throttle pedal readings, especially the APS 1 and APS 2 voltage readings.
 - **Depress the throttle pedal and hold for 30 seconds.**
 - APS 1 and APS 2 voltage readings should remain stable.
2. Test the bus with engine ON.
 - Open back door to enable the throttle interlock in order to disable the engine throttle.
 - Exercise the throttle pedal.
 - Observe the INSITE throttle pedal readings, especially the APS 1 and APS 2 voltage readings.
 - **Depress the throttle pedal and hold for 30 seconds.**
 - APS 1 and APS 2 voltage readings should remain stable.

Key Observations at Full Throttle Position

- **Good APS 1 (PASS condition):**
 - Reading is 4.25 V and steady when throttle pedal fully depressed.
- **Bad APS 1 (FAIL condition):**
 - Reading is unstable with throttle pedal being held steady.
- **Bad APS 1 (FAIL condition):**
 - Reading is around 4.19 V (low).
- **Good APS 2 (PASS condition):**
 - Reading is 2.13 V and steady when throttle pedal fully depressed.
- **Bad APS 2 (FAIL condition):**
 - Reading is unstable with throttle pedal being held steady.
- **Bad APS 2 (FAIL condition):**
 - Signal 2 is about 2.03 V (low).

Note: Any of the abovementioned bad APS readings (FAIL condition) should normally lead to 1242 FC activation.

Throttle Pedal Testing Procedure Background

- The TPS readings specified above have been collected through several throttle pedal sensor 1242 FC investigations.
- This testing procedure might not be 100% accurate but many field tests have shown it to be dependable.
- This testing procedure is an efficient first step towards permanently resolving 1242 FC issues.

Throttle Pedal Test Records

- Capture and save screenshots of any failing APS readings.
- Examples of typical APS 1 and APS 2 good and bad reading values are presented in the following figures.

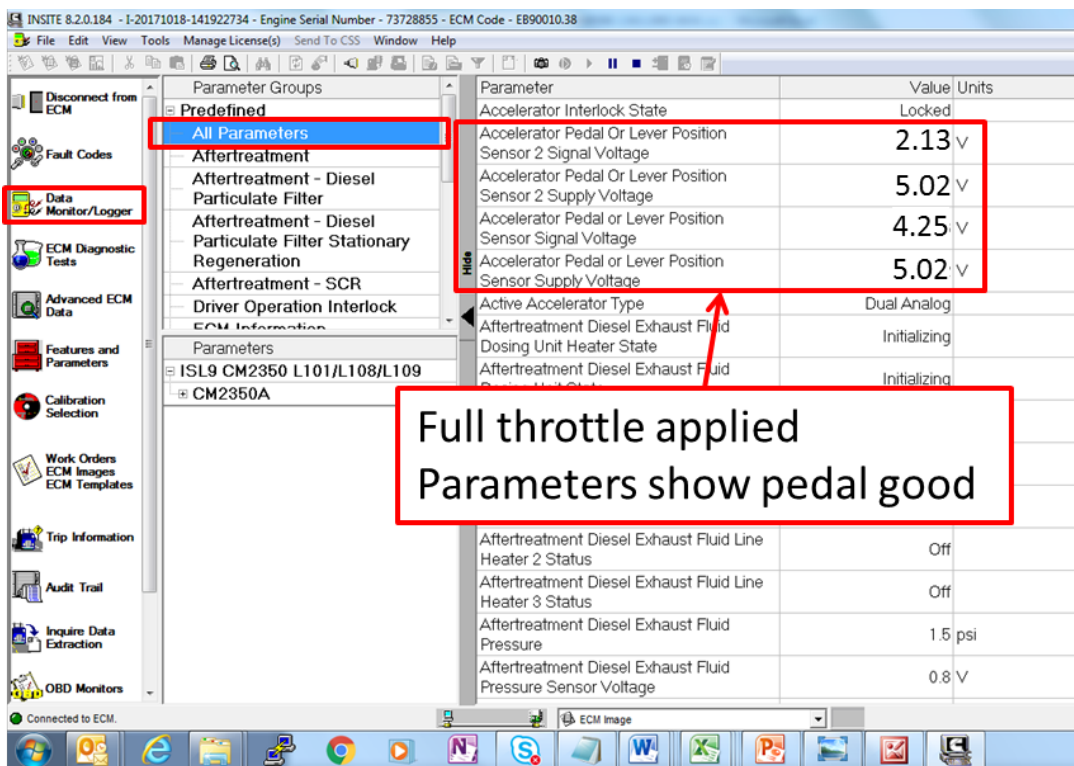
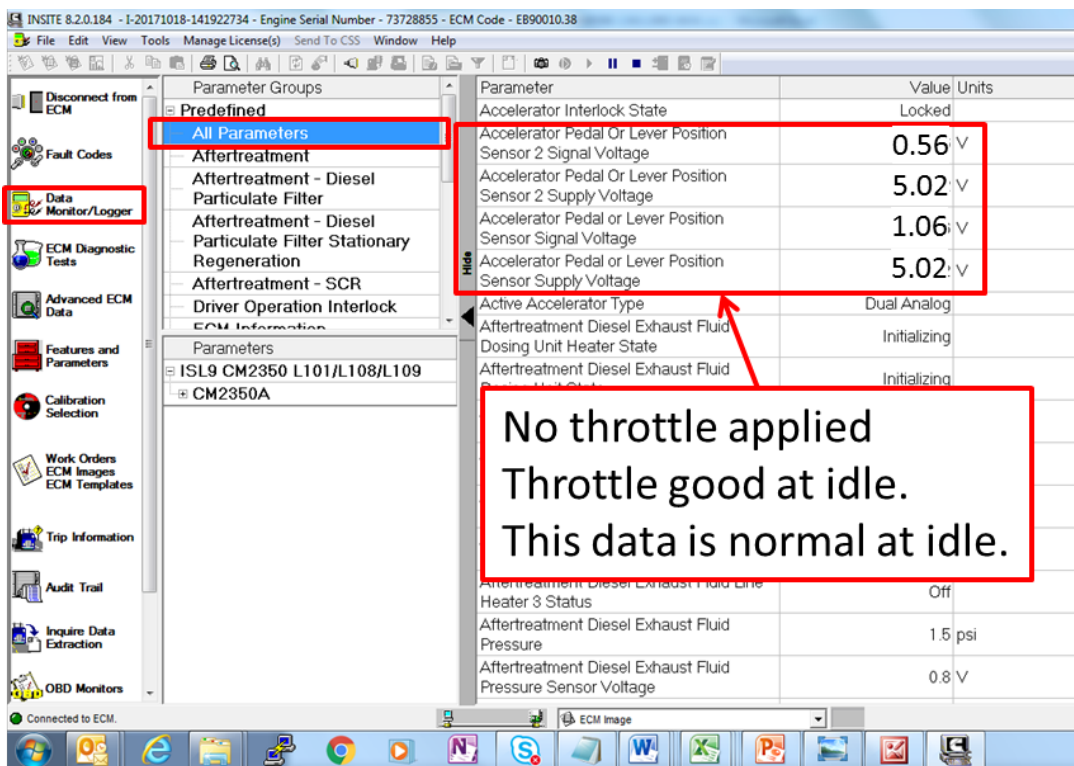

Figure A3.2. Example of INSITE Normal (PASS) Readings at Idle and Full Throttle Positions

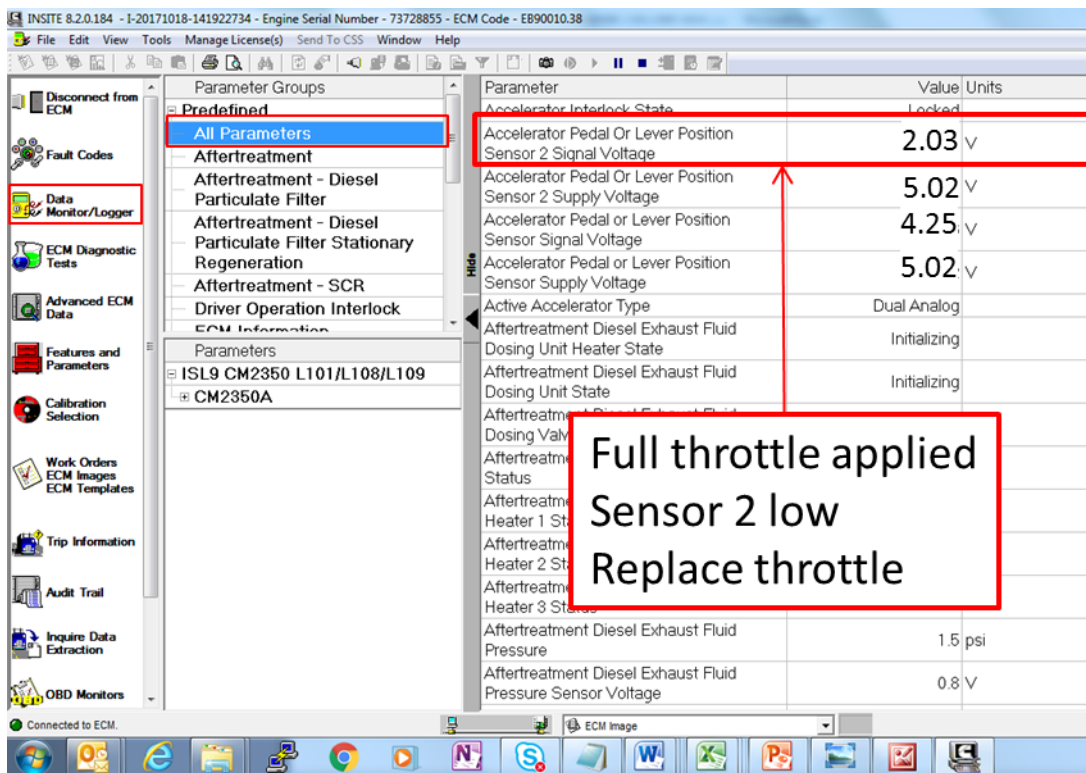
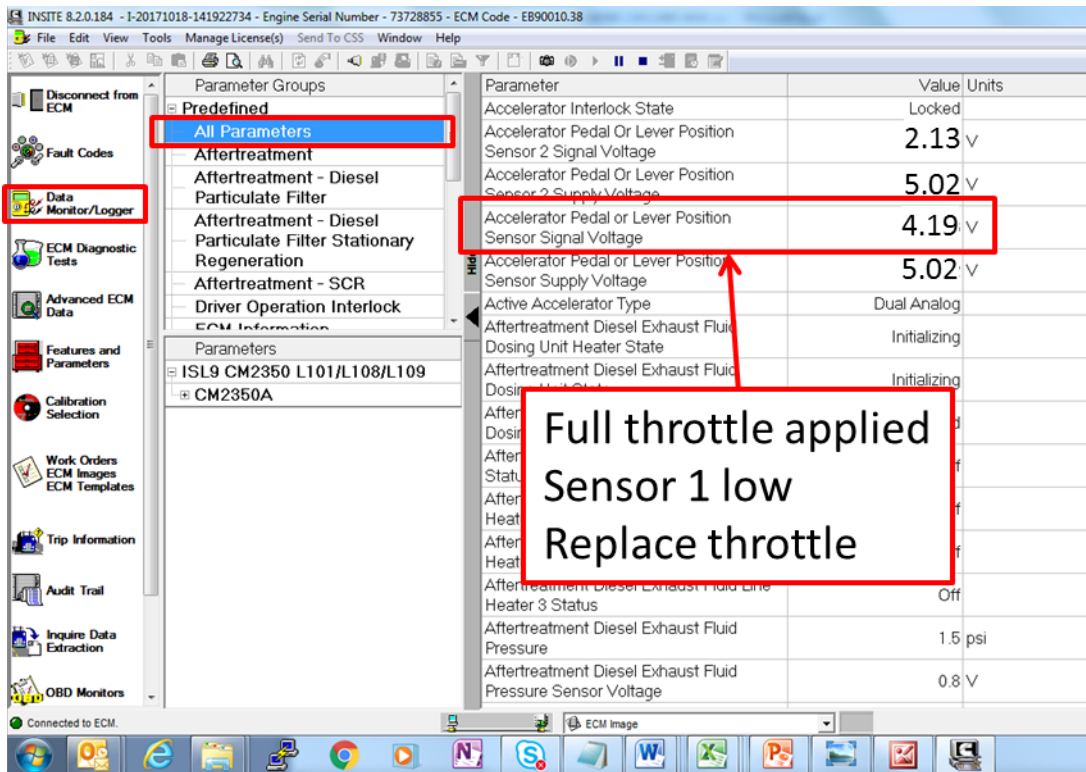

Figure A3.3. Example of INSITE Abnormal (FAIL) Readings at Full Throttle Pedal Position