	GROUP <b>Product Improvement</b>	MODEL <b>See Model List on Page 1</b>
	NUMBER <b>PI1802W/X (Rev 4, 04/03/2019)</b>	DATE <b>October 2018</b>
<b>PRODUCT IMPROVEMENT CAMPAIGN</b>		
SUBJECT: <b>ENGINE REPLACEMENT INSTRUCTIONS FOR DTC P1326 (PI1802W/X)</b>		

**\* NOTICE**

**This bulletin has been revised to include additional information. New/revised sections of this bulletin are indicated by a black bar in the margin area.**

This bulletin provides information related to the Technical Service Bulletin previously published in July 2018 ([PI1802](#), Rev 6, 01/31/2019) titled “Knock Sensor Detection System - ECU Logic Improvement”. Specifically, this bulletin provides instructions on which procedures to follow if, after installation of the KSDS, any one of the subject vehicles below returns to the dealer with Diagnostic Trouble Code (“DTC”), P1326.

Year	Model	Engine	Production Date
2014	Optima (TF)	2.4L GDI	8/29/13 – 4/25/14
2015-2018	Optima (TF/QF/JF/JFa)	2.4L & 2.0L T-GDI	4/16/14 – 7/11/18
2014-2018	Sportage (SL/QL)	2.4L & 2.0L T-GDI	9/30/13 – 4/5/18
2015-2018	Sorento (XMa/UMa)	2.4L & 2.0L T-GDI	1/3/14 – 3/7/18

If DTC P1326 is present, first check for any wiring signal interference following the procedure set forth below before determining whether an engine replacement is necessary. Based on the results of the Wiring Signal Interference Check, dealers are to perform either the Knock Sensor Wiring Repair or, if the engine noise inspection result confirms it, the Engine Long-Block Replacement, according to the procedures in this TSB.

If the vehicle’s engine is already seized or severely knocking, dealers are to perform the Engine Long-Block Replacement **and** the Wiring Signal Interference Check according to the procedures in this TSB.

**A [Vehicle Diagnosis Number \(VDN\)](#) must be created with DTC P1326, prior to performing PI1802W/X. If a VDN is not created, Warranty claim submission issues may occur.**

Before conducting the procedure, verify the vehicle is included in the list of affected VINs.

**\* NOTICE**

**To ensure complete customer satisfaction, always remember to refer to WebDCS Warranty Coverage (validation) Inquiry Screen (Service → Warranty Coverage → Warranty Coverage Inquiry) for a list of any additional campaigns that may need to be performed on the vehicle before returning it to the customer.**

**File Under: <Product Improvement>**

---

**Circulate To:**     **General Manager**     **Service Manager**     **Parts Manager**  
 **Service Advisors**     **Technicians**     **Body Shop Manager**     **Fleet Repair**

**Flow Chart:**

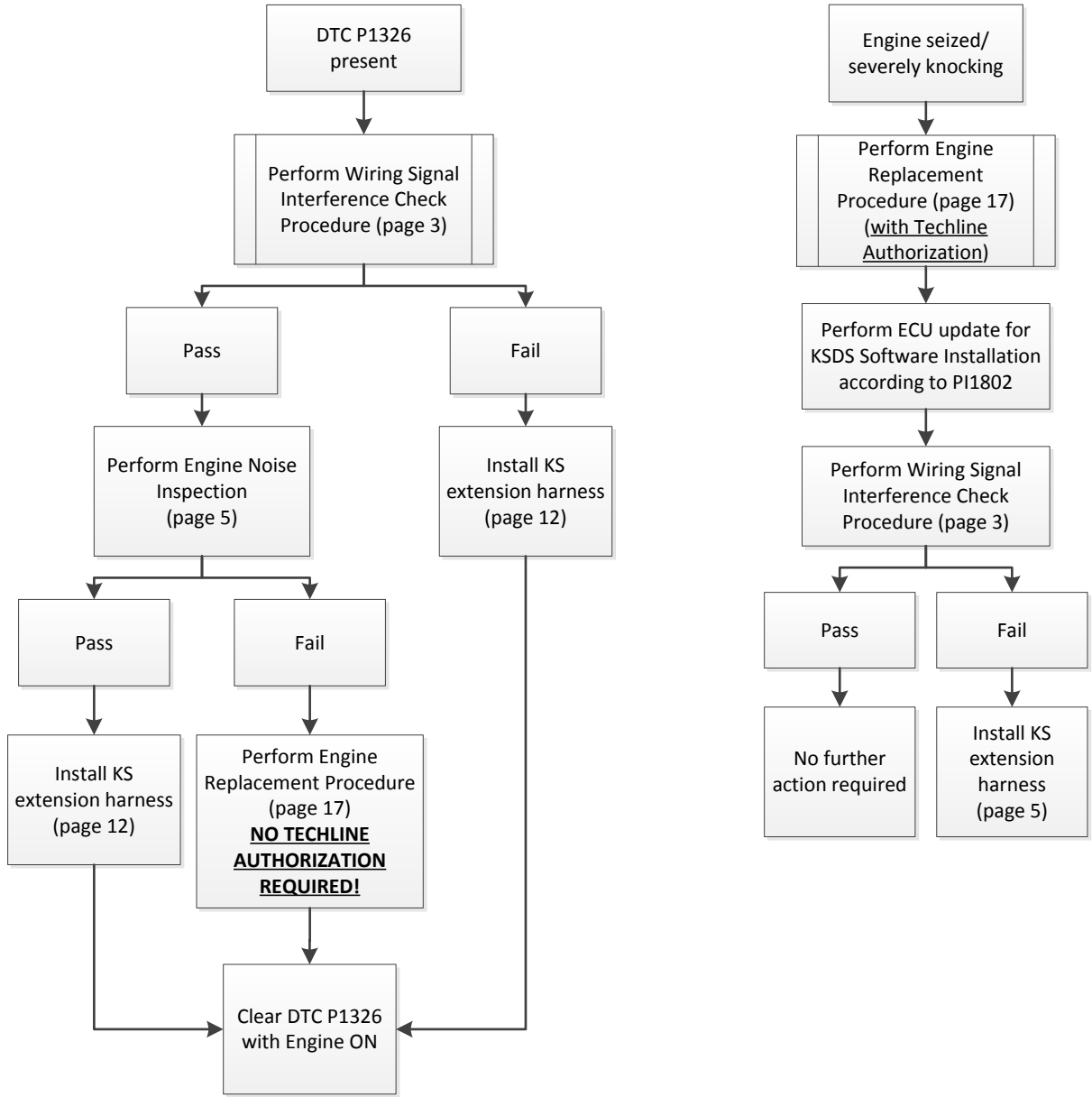

**Note:** If any concerns arise after completing the flow chart, open a Techline case online.

**SUBJECT: ENGINE REPLACEMENT INSTRUCTIONS FOR DTC P1326 (P11802W/X)**
**Wiring Signal Interference Check Procedure:**

- Using the KDS (connected to the internet), perform a Fault Code Search and confirm DTC P1326 is present.
  - If P1326 is present, proceed to the next step to perform the wiring signal interference check.
  - If the engine is seized or severely knocking, proceed to the engine replacement procedure on page 17 (with Techline authorization per Flow Chart).

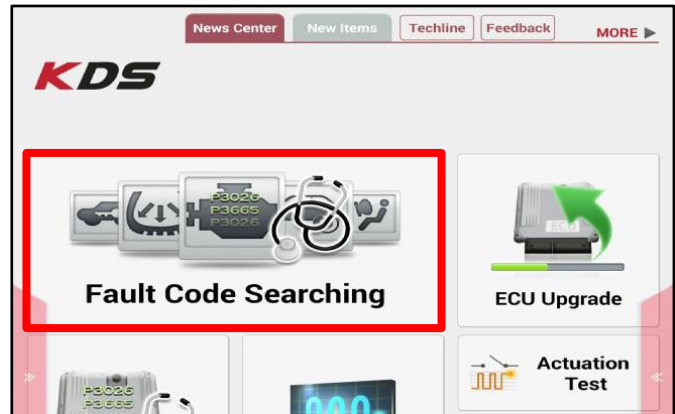

- Start/warm up the engine and ensure ENGINE OIL is at operating temperature (176°F).

The screenshot shows the 'Data Analysis' screen with a table of sensor data. The 'Engine Oil Temperature' row is highlighted with a red box.

Sensor Name(167)	Value	Unit	Link Up
Battery Voltage	13.3	V	
Battery Voltage after IG Key	13.3	V	
Actual Engine Speed	653	RPM	
Engine Oil Temperature	176.0	'F	

- From the KDS Home Screen, select S/W Management.



- Select Engine Control → Wiring Signal Interference Check.

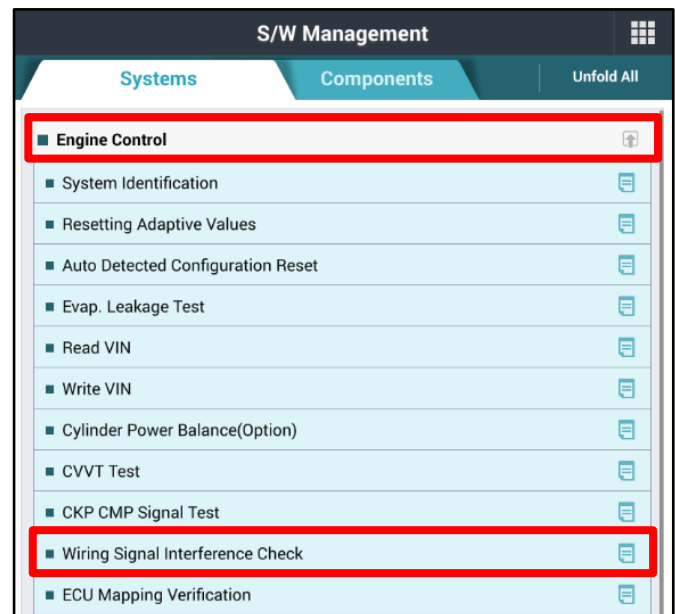

**SUBJECT: ENGINE REPLACEMENT INSTRUCTIONS FOR DTC P1326 (PI1802W/X)**

5. Ensure the engine is on and at idle and **ENGINE OIL** temperature is at 176°F degrees or higher. Select OK to proceed.

• Wiring Signal Interference Check	
Purpose	This function is to check wiring signal interference by measuring knock sensor values.
Enable Condition	1. Engine On 2. Engine oil temp must be higher than 176°F (80°C) 3. Do not push accelerator pedal
Concerned Component	-
Concerned DTC	-
Fail Safe	-
Etc	

**OK**

- 5b. Select OK to proceed.

**NOTE:** This test should only be performed if Knock Sensor Detection System - ECU Logic Improvement (PI1802) has previously been completed.

• [ Wiring Signal Interference Check ]

This function is to check wiring signal interference by measuring knock sensor values.

• [ Test Requirements ]

1. Engine Status : Idle
2. Engine oil temp must be higher than 176°F (80°C)
3. Do not depress accelerator pedal

**⚠ [ Warning ]**  
Run the test after completing ECU upgrade.

[OK] button : Go to next  
[Cancel] button : Go to main Screen

**OK**      Cancel

- 5c. If the conditions are not met, a pop-up as shown will be displayed.

**Information**

The requirement below is not met!

[ Do not depress accelerator pedal ]

Press [OK] button and try again.

**OK**

6. Enter vehicle mileage and RO number (VIN is automatically populated).

• [ Wiring Signal Interference Check ]

Enter mileage and RO.

[OK] button : Go to next  
[Cancel] button : Go to main screen

VIN : 5XX (17 digits)

Mileage :  mile (up to 999,999)

RO :  (up to 12 digits)

**OK**      Cancel

**SUBJECT: ENGINE REPLACEMENT INSTRUCTIONS FOR DTC P1326 (P11802W/X)**

7. Wiring Signal Interference Check test will begin and take about three (3) minutes to complete. **NOTE:** Do not push on the accelerator pedal.

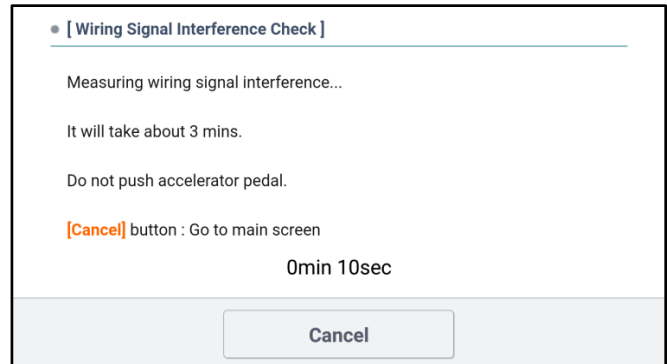

- If the result is “OK”, proceed to the Engine Noise Inspection procedure on page 5.

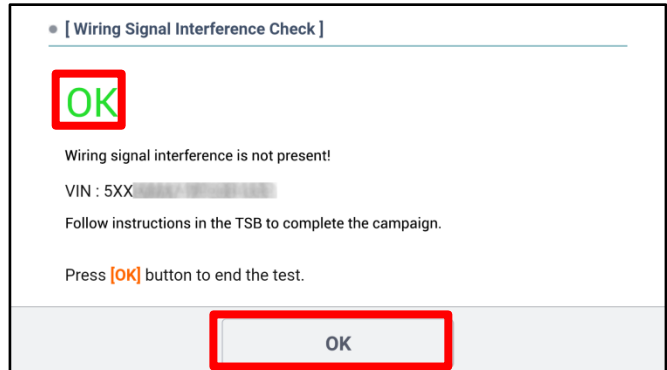

- If the result is “NOT OK”, turn the engine off and proceed to **step 2** of the Knock Sensor (KS) Extension Harness Installation procedure on page 12.

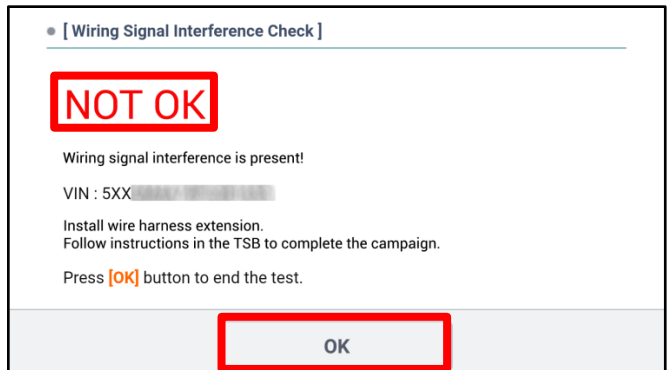
**Engine Noise Inspection Procedure:**

1. Prior to inspection, ensure the KDS is fully charged and is connected to the internet every day to ensure the latest update is received and installed.
  - Engine oil level should be at the “FULL” mark. Top off with 5W-30 if required.
  - Test requires the engine to be in satisfactory running condition and able to idle normally.
  - Engine coolant temperature should be above minimum test temperature: 185°F (85°C).

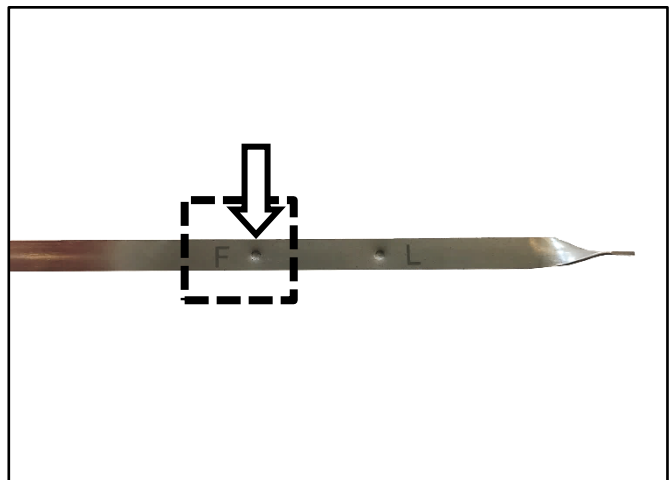

If the engine’s running condition is poor due to issues unrelated to a connecting rod knocking noise (faulty sensors, intake/exhaust manifold leak, catalytic converter, etc.), diagnose and repair prior to performing this inspection procedure. If the engine cannot be tested or has other major concerns, **see Warranty Claim Authorization information on page 40.**

2. With the engine off, remove the dipstick (A).

**\* NOTICE**

Engine cover removed in images for demonstration-only purposes.

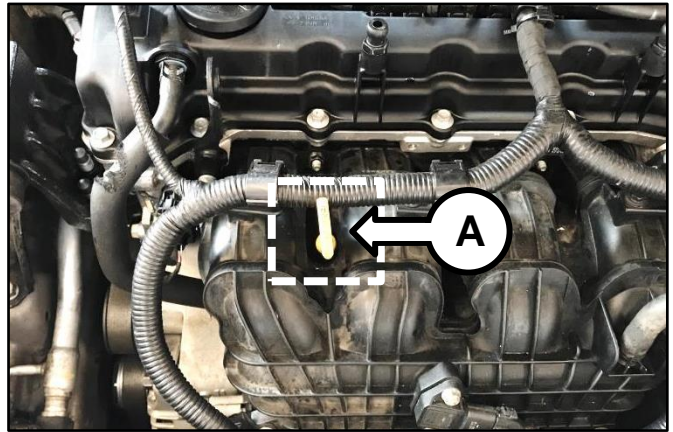

3. Insert the engine noise tester SST adapter (B) into the dipstick tube then start and idle the engine.

**\* NOTICE**

To avoid false readings, ensure the adapter (B) is properly inserted into the dipstick tube and that the tube is not in contact with the intake manifold.

If the dipstick tube is not centered and is close to or touching the manifold, carefully adjust (bend) and center the dipstick tube with a pry bar.



[Click here for a video tutorial of the Inspection Procedure.](#)

4. Connect the 3.5 mm male end of the engine noise tester SST (C) to the 3.5 mm female end of the extension cable (D).

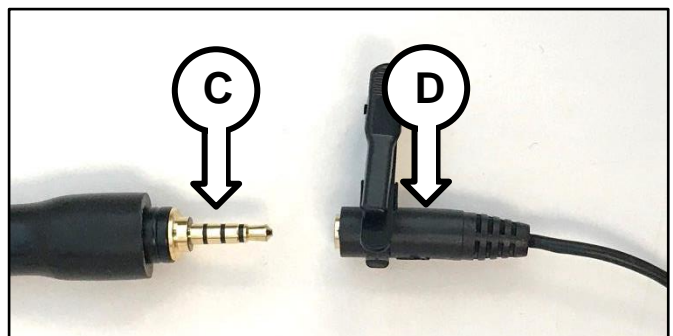
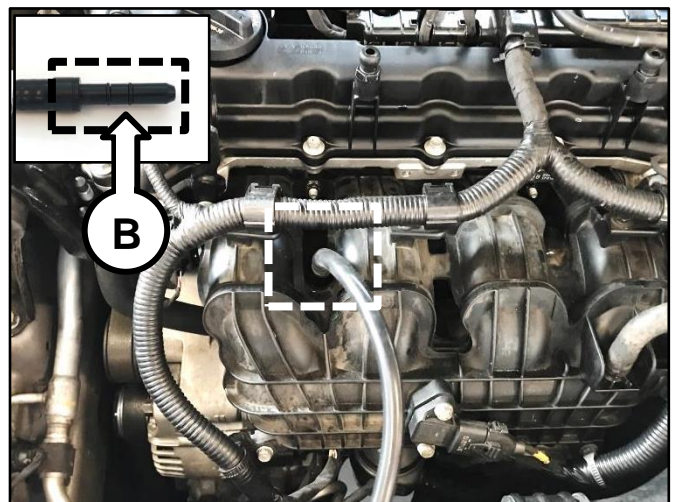
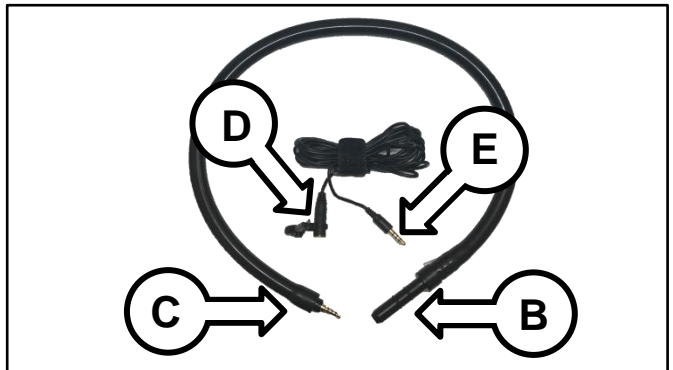

## SUBJECT: ENGINE REPLACEMENT INSTRUCTIONS FOR DTC P1326 (PI1802W/X)

5. Attach the SST clip of the extension cable (D) to the hood latch.

**\* NOTICE**

Make sure to route the extension cable away from moving parts (pulleys, fan, and belts and be careful not to get it pinched between door and body or window, etc.).

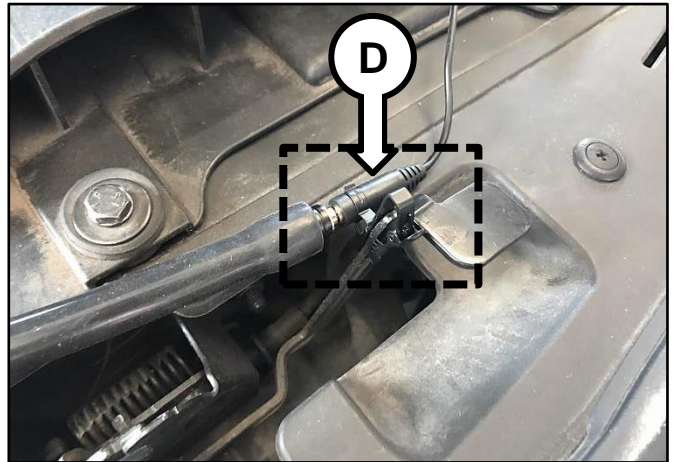

6. Connect the 3.5 mm male end (E) of the extension cable to the headphone port located at the upper left corner (KDS version 1.0) or at the bottom of the tablet (KDS version 2.0).

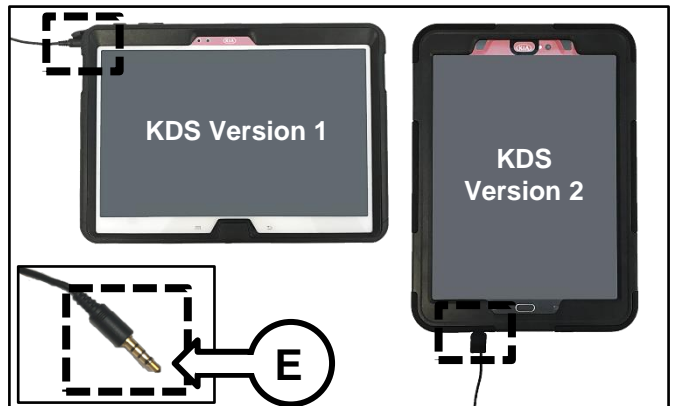

7. Connect the VCI-II to the OBD-II connector and launch the KDS application from the KDS tablet home page.



8. Confirm communication with VCI (F) and then configure the vehicle (G) using the **AUTO VIN** (H) feature.

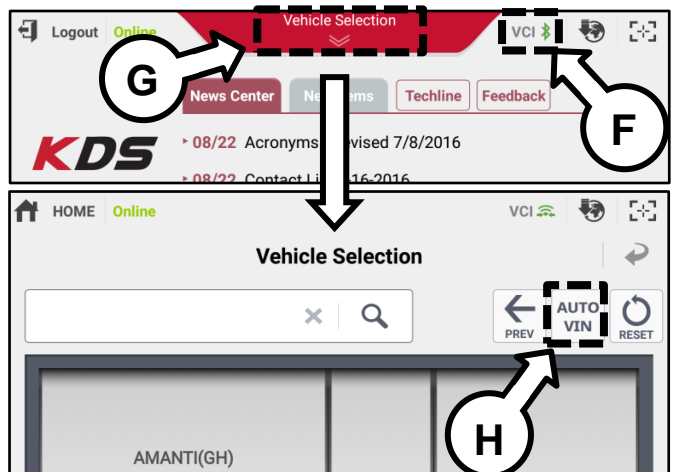

**SUBJECT: ENGINE REPLACEMENT INSTRUCTIONS FOR DTC P1326 (PI1802W/X)**

- Swipe up the “More” tab from the lower screen of the KDS and select “Special Inspection”.

**\* NOTICE**

If the vehicle model/model year does not qualify for this campaign, a message will pop up; if so, verify that the vehicle is included in the list of affected VINs.

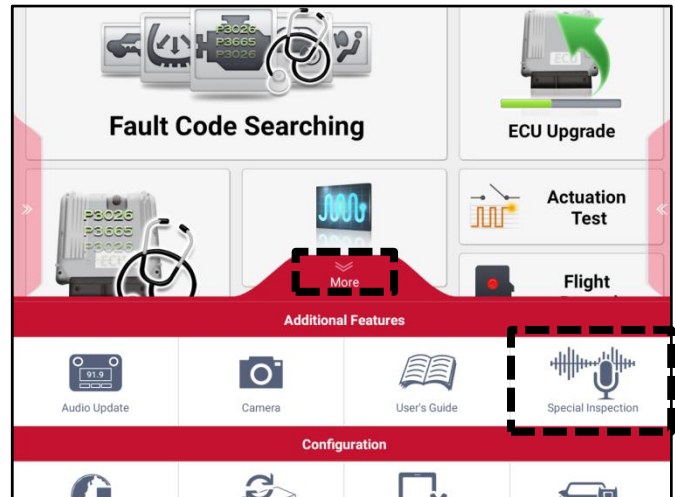

- Complete the vehicle information form on the screen:

- Mileage
- RO number
- Select “Verify” to verify the VIN

**Note: VIN must be verified with the “Verify” function in order to proceed to the next step.**

Select “Next” to continue.

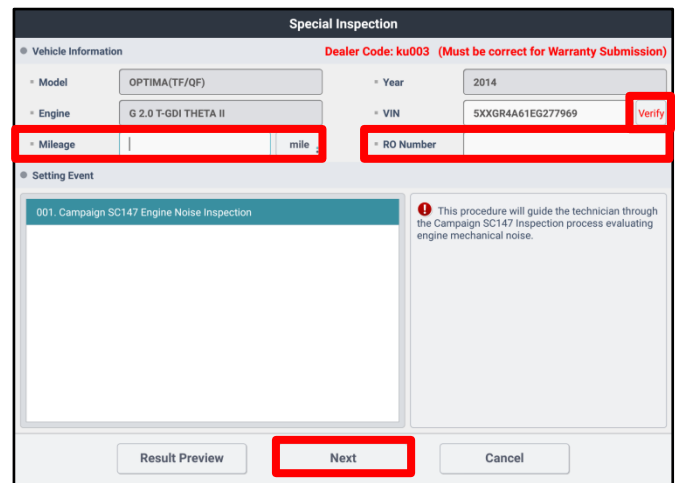

- Confirm that all of the pre-inspection items listed on the screen are true:

- Engine Oil Level – Normal
- Coolant Level – Normal
- Engine Cover – Installed
- Driver Window – Opened
- A/C & Blower Motor – OFF
- Audio & All Accessories – OFF
- Engine – Warm up (185°F or higher)
- Insert “A” into dipstick tube
- Connect “B” part at tablet headphone port

Select “Next” after checking items mentioned above.

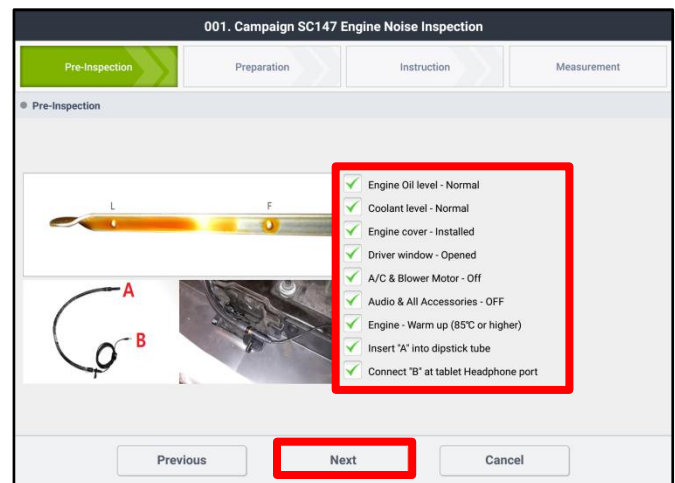



**SUBJECT: ENGINE REPLACEMENT INSTRUCTIONS FOR DTC P1326 (P11802W/X)**

12. The program will automatically check the engine sensors' data. Select the "Next" button if all the conditions are satisfied.

- Engine Coolant Temperature: 185°F or higher
- A/C Request to ECU: OFF

**Note:** If the test item result is "NOT GOOD", correct the condition then select "Refresh Data".

001. Campaign SC147 Engine Noise Inspection

Pre-Inspection Preparation Instruction Measurement

Refresh Data

All Results below must be "GOOD" before proceeding.

Test Item	Value	Unit	Result
Engine Coolant Temperature	185.0	°F	GOOD
AC Request to ECU	OFF	-	GOOD

Previous Next Cancel

13. Follow the instructions on the screen then select "Next".

001. Campaign SC147 Engine Noise Inspection

Pre-Inspection Preparation Instruction Measurement

Instruction

• Inspection should be performed in an area where wifi connectivity is available.

• Make sure tubing is not kinked or pinched.

• Open the driver's window. Run engine noise inspection tool through windows.

• Make sure Engine Noise Inspection Tool has clear path to the tablet.

• Do not tap or pinch Engine Noise Inspection Tool during measurement.

• Engine should be at normal operating temperature and must be higher than 85 degrees Celsius.

• Enable the tablet mute function so that the touch tone and all other audio notifications are disabled.

**Test Procedure**

- Step 1 - Inspection tool preparation (2000-3000rpm 30 sec)
- Step 2 - 2000 rpm test (2000rpm)
- Step 3 - Idle test (550-800rpm)

Previous Next Cancel

14. Prior to the initial measurement, the program will automatically check if the engine noise tester is installed and operating correctly at engine idle and perform an internal diagnosis.

Begin the second part of the engine noise tester check by selecting "Start".

### \* NOTICE

If the measured noise level is too low or abnormally high, an engine noise tester inspection message will pop up. Check and correct as necessary and start again.

001. Campaign SC147 Engine Noise Inspection

Pre-Inspection Preparation Instruction Measurement

704 rpm

Press Start Button

Start

2000rpm Test  
- Maintain engine rpm between 1,900-2,200 until 3 tests are completed.

Idle Test  
- Maintain engine rpm between 550-800 until 3 tests are completed.

Measurement 1 of 3 Pending Measurement 1 of 3 Pending  
Measurement 2 of 3 Pending Measurement 2 of 3 Pending  
Measurement 3 of 3 Pending Measurement 3 of 3 Pending

**IMPORTANT**  
A/T in Park with Parking brake applied.  
M/T in Neutral with Parking brake applied.

Previous Restart Cancel

- With the vehicle in Park (A/T) / Neutral (M/T), increase and maintain the engine speed at 2,000-3,000 RPM for thirty (30) seconds.

The program will automatically proceed to the next step when the engine noise tester is ready.

**\* NOTICE**

Once the RPM is in the specified range, the time count (green bars) will be initialized.

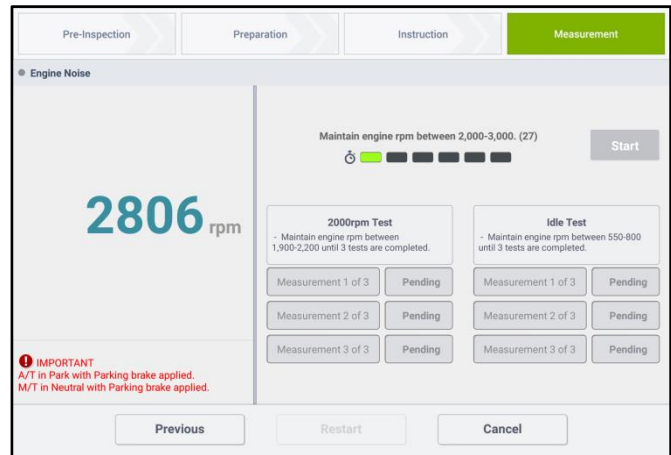

- With the vehicle in Park (A/T) / Neutral (M/T), begin the “2000rpm Test” by increasing and maintaining engine speed between 1,900-2,100 (2.4L) or 1,900-2,200 (2.0T) RPM until all three (3) measurements are complete.

- When the “2000rpm Test” is complete, release the accelerator pedal so that engine maintains idle state for the “Idle Test”.

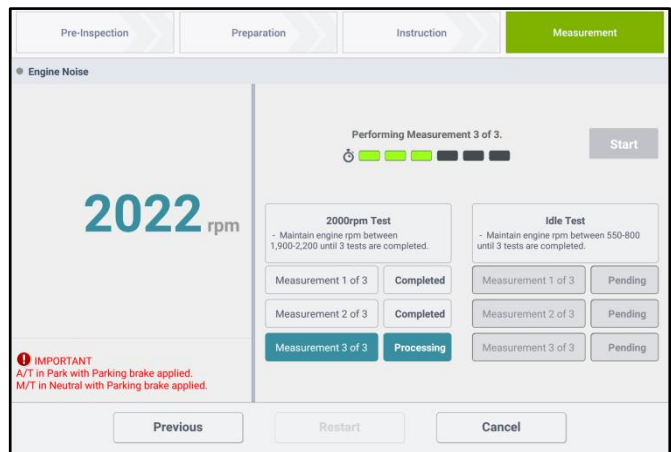

- The “Idle Test” will automatically begin. Keep the engine at idle and wait until all three (3) measurements are complete.

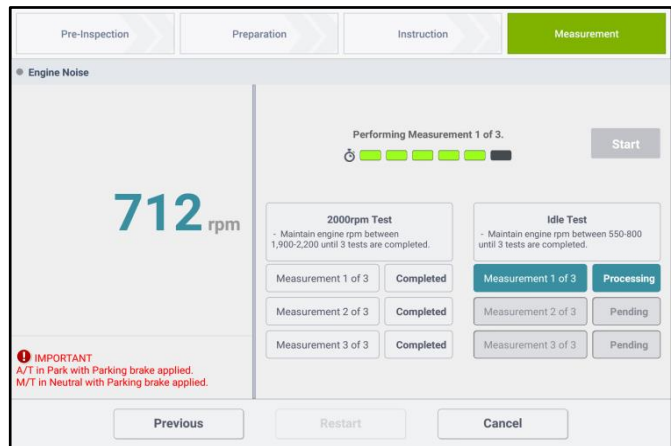

## SUBJECT: ENGINE REPLACEMENT INSTRUCTIONS FOR DTC P1326 (PI1802W/X)

19. After the completion of the engine noise inspection, the KDS will automatically generate/display a “PASS” or “NO PASS” result.
- If the inspection result is “PASS”, proceed to the KS Extension Harness Installation procedure on page 12.
  - If the inspection result is “NO PASS,” proceed to the engine replacement procedure on page 17.
  - If the inspection result is “RETEST” with an error code, see Adapter Error Code chart in Appendix 4 on page 45 for corrective action then repeat the inspection procedure starting from step 9.

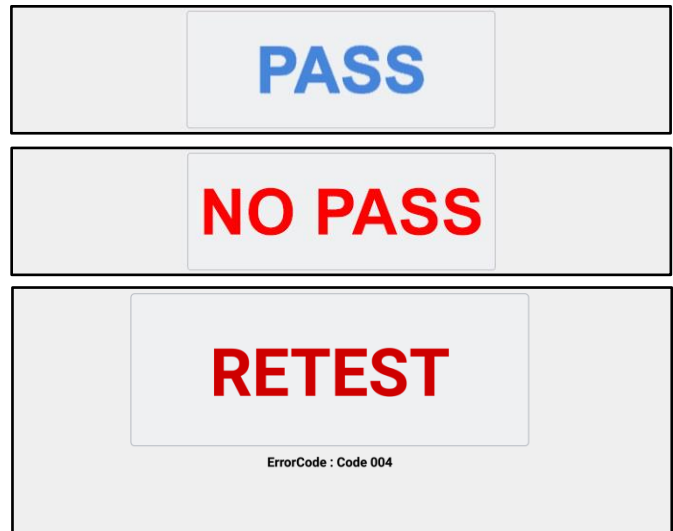

20. Select “Finish” to complete the engine noise inspection. Ensure the KDS is connected to the internet and the “Special Inspection” KDS application is open to automatically submit the results to the Kia Server. To save and/or print the results as PDF, select “Print”.

If the KDS is not connected to the internet, up to five (5) results will stay pending in the queue until the KDS is connected to the internet with the “Special Inspection” application open.

**Note: The five (5) pending results must be submitted before a sixth (6<sup>th</sup>) test can be conducted.**

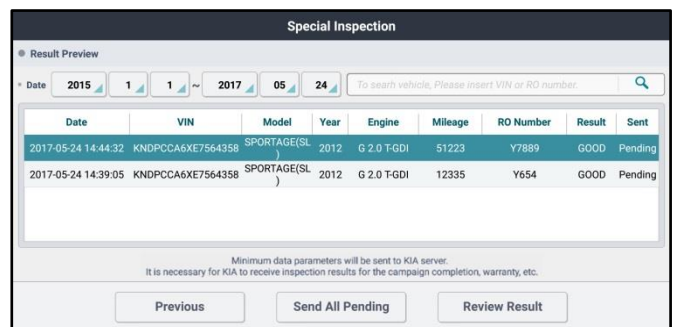
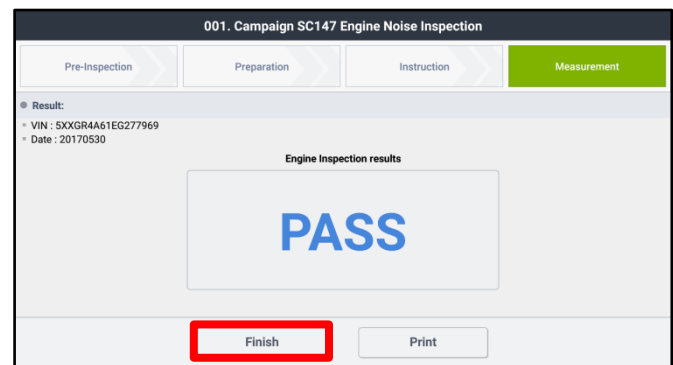

21. Disconnect the engine noise tester from the KDS and carefully remove the adapter (B) from the dipstick tube by grasping the engine noise tester adapter.

**KS Extension Harness Installation Procedure:**

**NOTE:** Photos below are from a 15MY Optima (QF). Components and their location may vary in different models.

1. Inspect the ECU harness (A) and verify if the Knock Sensor wiring extension harness (B) has previously been installed.

**NOTE:** To identify the extension harness (B), look for an external harness (B) which should be cable-tied to the existing wiring harness (A) leading by the intake manifold (C) to the knock sensor (D), as shown.

- If the extension harness (B) has been installed, open a Techline case online.
- If the extension harness (B) has not been installed, proceed to the next step.

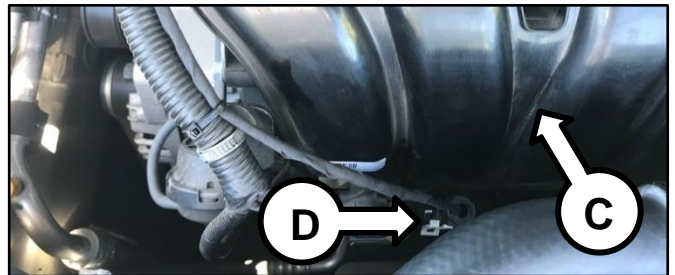
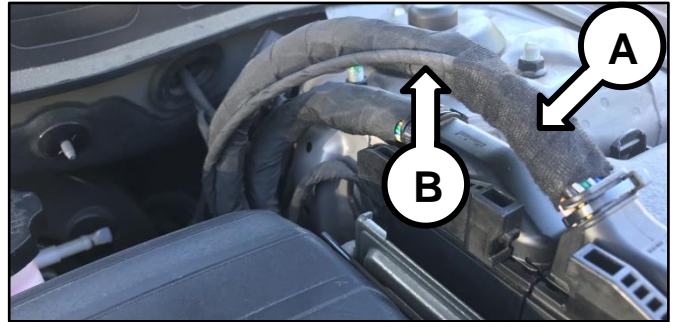

2. Remove the air cleaner and duct assembly (E).

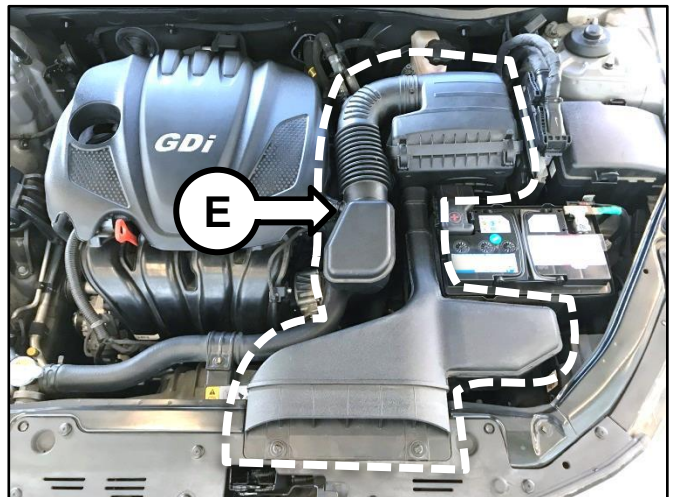

3. Disconnect the ECU connector\* (figure F1 or F2) (\*see IMPORTANT note below).

**\* IMPORTANT**

Location of the ECU connector may vary from model to model. Refer to the table on page 13 for the ECU connector number and the applicable ETM Manual on KGIS for the location of the ECU connector.

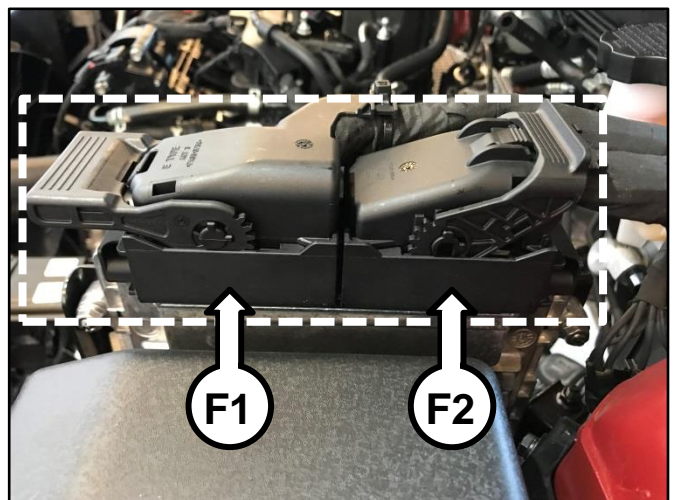

## SUBJECT: ENGINE REPLACEMENT INSTRUCTIONS FOR DTC P1326 (PI1802W/X)

MY	Model	Engine	ECU Connector Number
2014-2015	TF	2.4	C200-B
2015	QF	2.4	C200-B
		2.0T	C100-B
2016-2018	JF/JFa	2.4	C200-A
	JFa	2.0T	C100-A
2015	XMa	2.4	C300-B
2016-2018	UMa	2.4	C100-A
		2.0T	C200-A
2014-2016	SL	2.4	CHGG-BG
		2.0T	CHTG-BG
2017-2018	QL	2.4	C100-A
		2.0T	C200-A

4. Cut the existing cable-tie (G) from the connector.

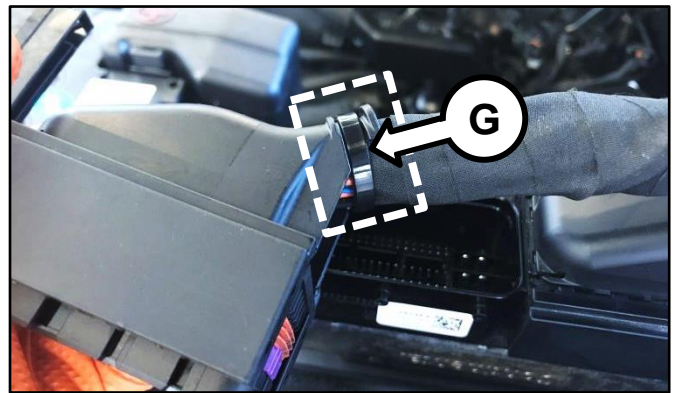

5. Remove the ECU connector cover (H) by carefully unclipping the two (2) tabs (I) and sliding the cover (H) towards the tabs (I).

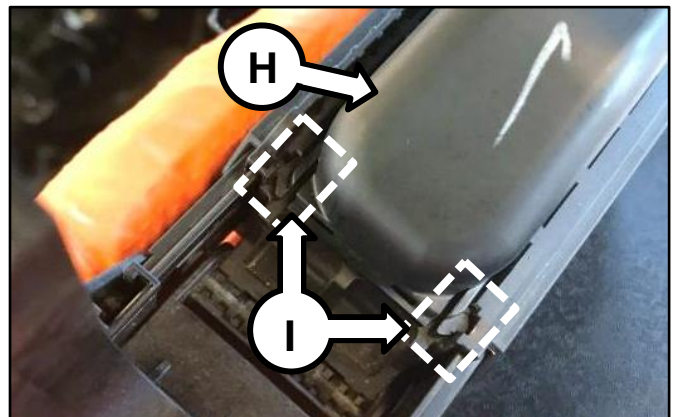

6. Carefully remove the electrical tape (J) to expose the harness wires.

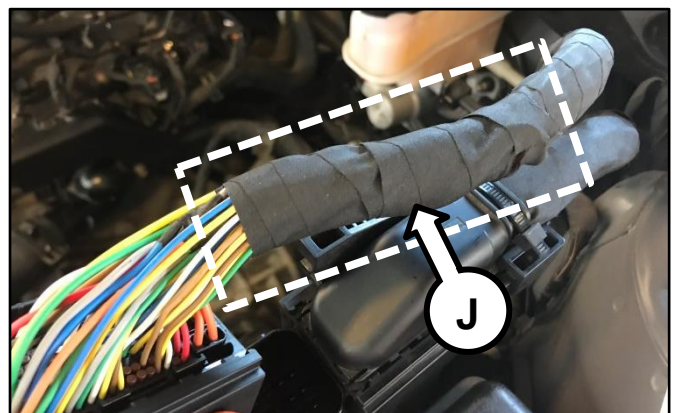

- Remove the pin retainer (K).

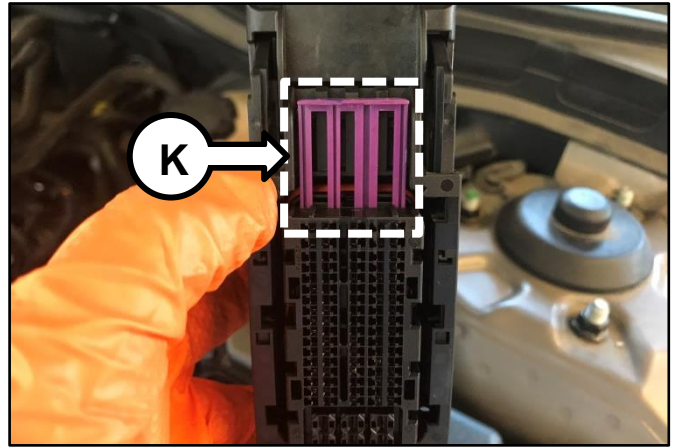

- Locate the three (3) knock sensor circuit terminals from the ECU connector. Refer to the “Schematic Diagrams → Engine Electrical System → Engine Control System → Schematic Diagrams” chapter of the applicable ETM on KGIS.



QF, TF, XMa, and SL	
Pin	Wire
44	Knock Sensor Shielded Ground
45	Knock Sensor Ground
62	Knock Sensor Interface (Signal)

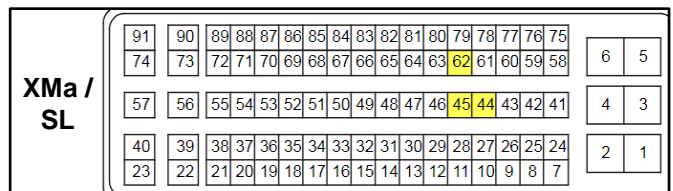

UMa, JF, JFa, and QL	
Pin	Wire
61	Knock Sensor Shielded Ground
62	Knock Sensor Ground
63	Knock Sensor Interface (Signal)

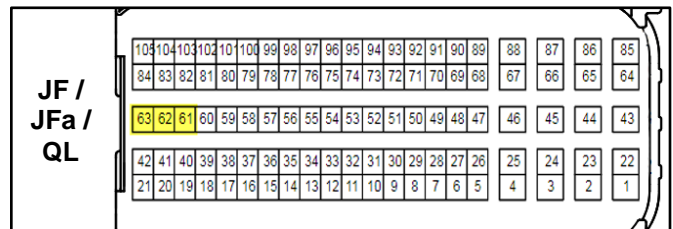

[Click here to see a video of terminal removal.](#)

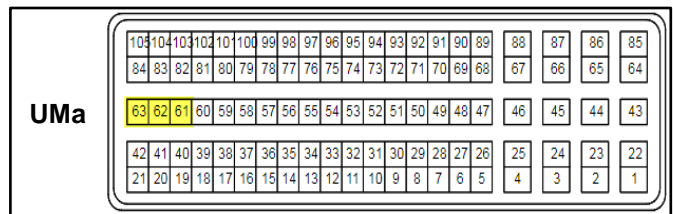

**\* IMPORTANT**

Location of the ECU connector may vary from model to model. Refer to the table on page 6 for the ECU connector number and the applicable ETM Manual on KGIS for the location of the ECU connector.

## SUBJECT: ENGINE REPLACEMENT INSTRUCTIONS FOR DTC P1326 (PI1802W/X)

9. Remove the three (3) terminals **one at a time** and insert the new terminals of the extension harness into the ECU connector (F). Reinstall pin retainer (K) and reassemble the connector (F).



QF, TF, XMa, and SL	
Pin	Extension Wire Color
44	Blue
45	Black
62	Red
UMa, JF, JFa, and QL	
Pin	Extension Wire Color
61	Blue
62	Black
63	Red

**NOTE:** Be sure to note the rotational position of the terminals during removal. They are directional and need to be reinstalled in the same “clock” position.

10. Route the extension harness (B) along the existing harness (A) leading by the intake manifold (C) to the knock sensor (D), **exactly** as shown.

**\* IMPORTANT**

The harness (B) must be routed exactly as shown to prevent related DTCs.

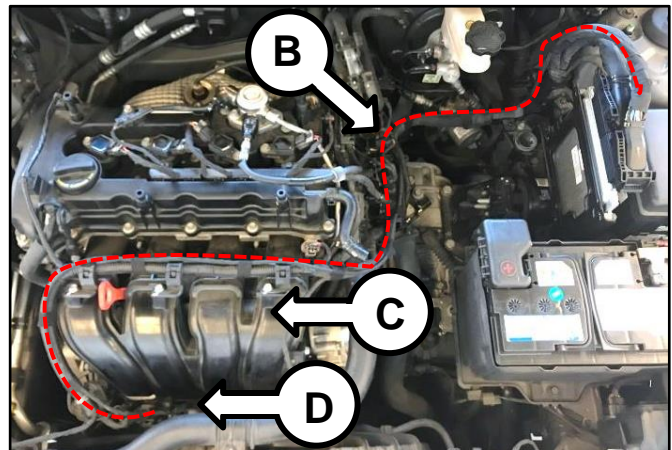

**\* IMPORTANT**

The harness (B) must be routed above and secured to the harness protector (L1) and **UNDER** the Breather Hose (L2) and Camshaft Position Sensor (L3).

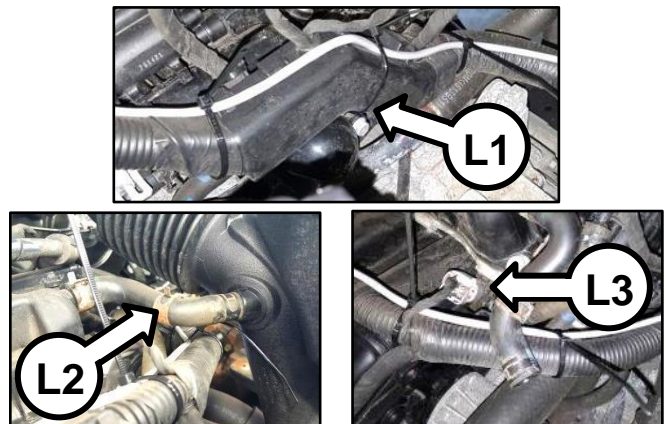

11. Connect the extension harness (B) to the knock sensor (D).

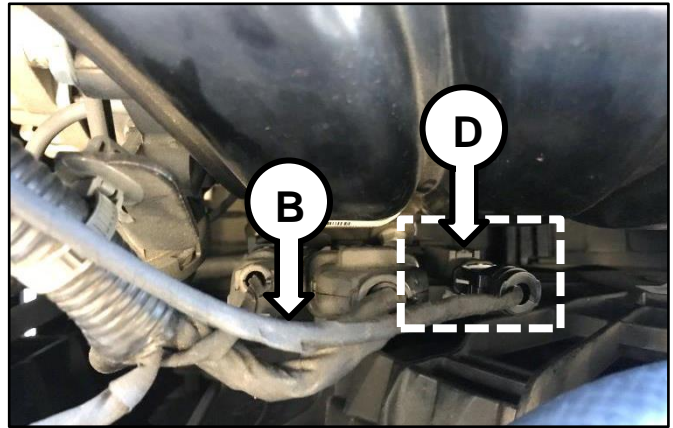

12. Cut off and discard the three (3) old knock sensor circuit terminals and the old knock sensor connector and secure the remaining wires to the new extension harness using the supplied electrical tape. **NOTE:** Complete removal of the old knock sensor wires is not necessary. Only remove the old terminals and connector.

13. Secure the extension harness at the connector (F) by replacing the cable-tie (G) removed in step 4 with a new supplied cable-tie and the electrical tape (J) removed in step 6 with new supplied electrical tape.

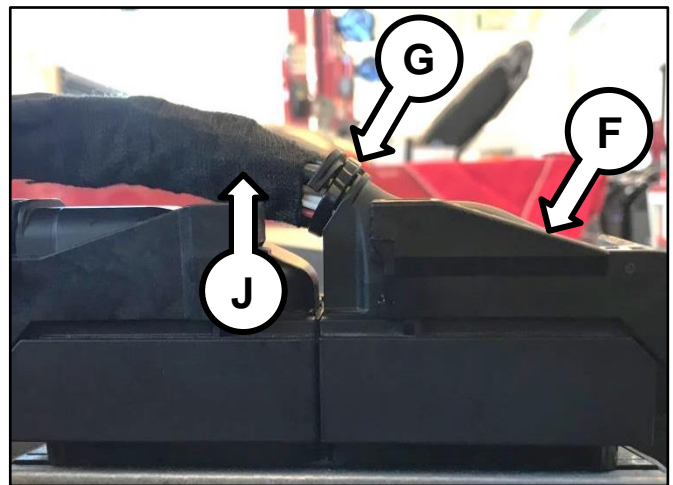

14. Secure the extension harness (B) to the existing harness (A) using the supplied cable-ties. Tuck and secure any excess wiring of the extension harness near the ECU with cable-tie.

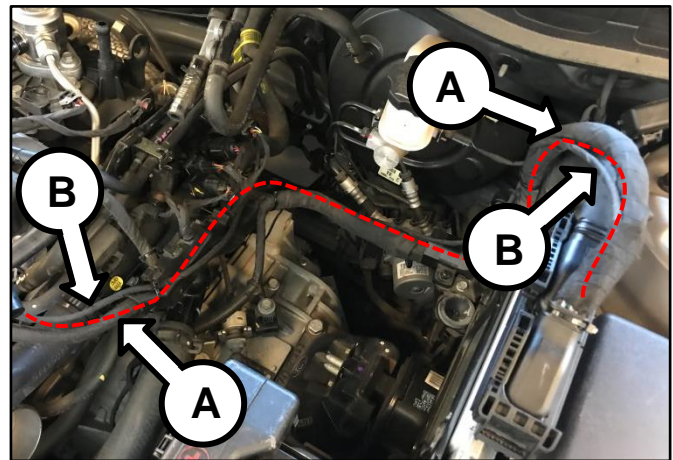

15. Reinstall all removed components in the reverse order of removal.
16. Erase the P1326 DTC with the KDS and start the engine to confirm proper operation.



**SUBJECT: ENGINE REPLACEMENT INSTRUCTIONS FOR DTC P1326 (P11802W/X)****Engine Replacement Procedure:**

1. Remove the engine assembly by referring to the “Engine And Transmission (Transaxle) Assembly → Engine And Transmission (Transaxle) Assembly → Repair procedures” chapter in the applicable Shop Manual on KGIS.

Refer to [TSB ENG190](#) for information regarding engine replacement practices.



2. After removal of the engine from the vehicle, remove all components that will need to be transferred by referring to the applicable Shop Manual on KGIS.
3. Place the new engine block on an engine stand.
4. Install all removed components from the old engine block onto the new engine block utilizing all parts from Service Kit I and II. Be advised of notes below.

**Tightening torque for Knock Sensor:**

**13.7 – 17.4 lb.ft (18.6 – 23.5 N.m, 1.9 – 2.4 kgf.m)**

**Notes:**

High Pressure Pump & Roller Tappet:

- Refer to [TSB ENG083](#) for special attention and handling procedures of GDI-specific components.
- When installing the high pressure pump and roller tappet onto the new engine, apply engine oil to the roller tappet, and O-rings of the high pressure pump.

**Tightening torques of pump bolts:**

**9.4 – 10.9 lb.ft (12.8 – 14.7 N.m,  
1.3 – 1.5 kgf.m)**

**Tightening torques of pipe flare nut:**

**19.5 – 23.9 lb.ft (26.5 – 32.4 N.m,  
2.7 – 3.3 kgf.m)**

**\* NOTICE**

Refer to [TSB ENG083](#) for gasoline direct injection (GDI) specific information, including related warnings and cautions for handling high fuel pressure system components.

## High Pressure Fuel Pipe:

1. Properly position the new fuel pipe (A) and then hand-tighten both flare nuts (B).

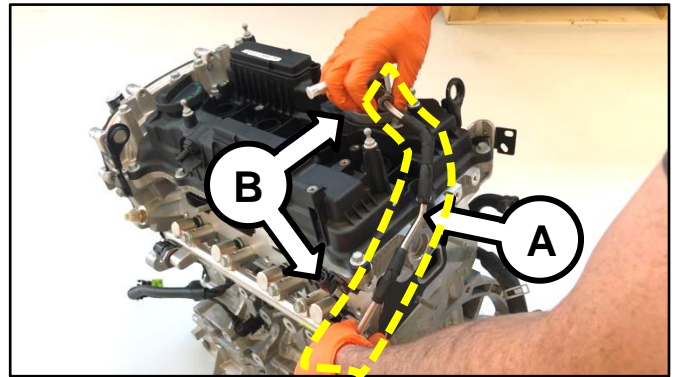

2. Install the pipe retaining bracket and bolt (C) and torque to specifications.

**\* NOTICE**

If the bracket and bolt are missing, order and install a new bracket and bolt.

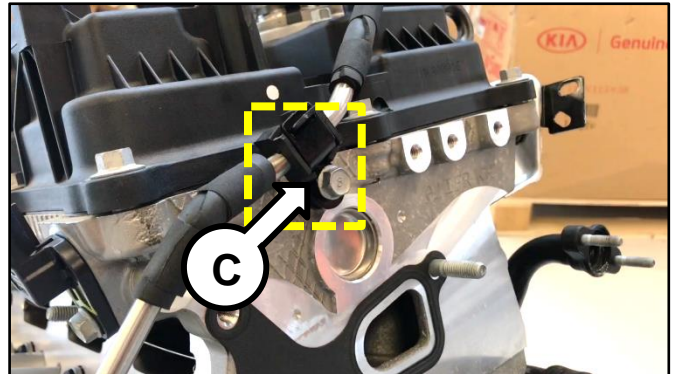

**Tightening torque (bracket bolt):**  
 5.8 – 8.7 lb.ft (7.8 – 11.8 N.m,  
 0.8 – 1.2 kgf.m)

3. Using a click-type/electronic torque wrench and SST 09314-3Q100, torque both flare nuts (B) to specifications.

**Tightening torque (flare nuts):**  
 19.5 – 23.9 lb.ft (26.5 – 32.4 N.m,  
 2.7 – 3.3 kgf.m)

[Click here to see a video tutorial of high pressure fuel pipe install \(includes high pressure pump install\).](#)

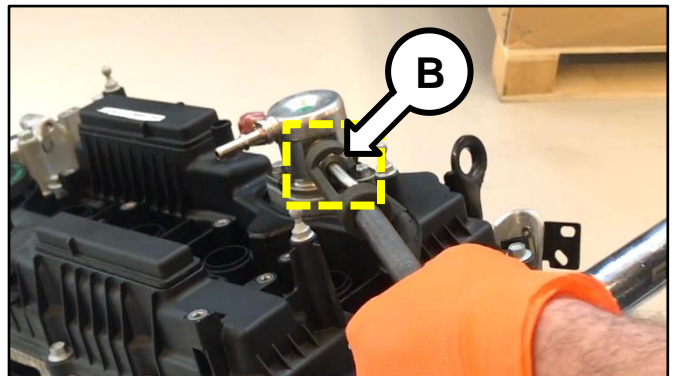
**\* IMPORTANT**

The high pressure fuel pipe bracket and bolt must be installed and properly torqued prior to torquing the high pressure fuel pipe flare nuts.

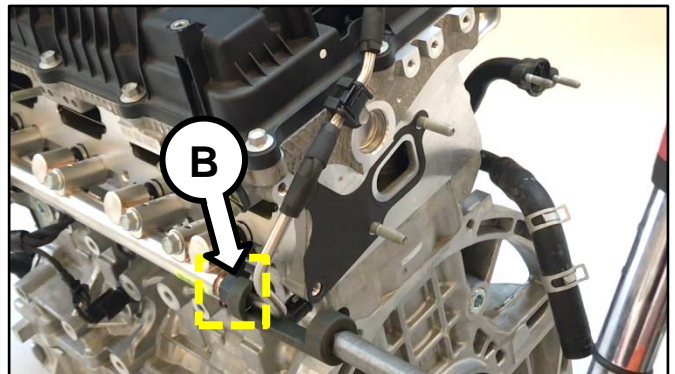

## SUBJECT: ENGINE REPLACEMENT INSTRUCTIONS FOR DTC P1326 (PI1802W/X)

## Delivery Pipe:

- Refer to [TSB ENG083](#) for special attention and handling procedures of GDI-specific components.
- Prior to installing the delivery pipe, be sure to replace all of the injector O-rings and injector retainers.
- Prior to installing the delivery pipe, apply engine oil to the injector O-rings.
- When installing the delivery pipe, use caution not to damage the tip of the injector.
- Be sure to replace the delivery pipe retaining bolts and torque them in the sequence shown.

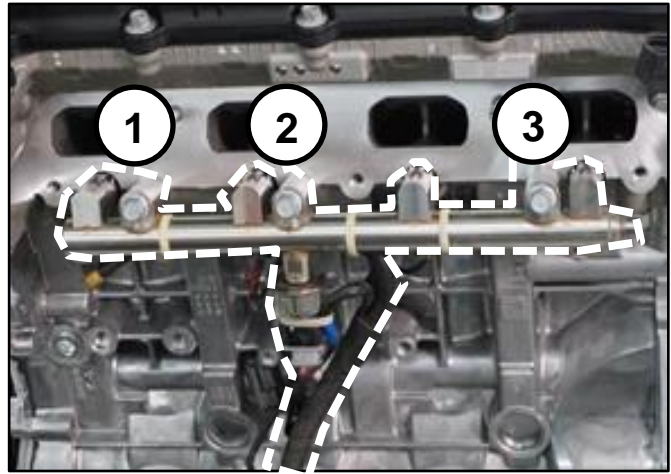
**Tightening torque of bolts:**

**13.7 – 17.4 lb.ft (18.6 – 23.5 N.m,  
1.9 – 2.4 kgf.m)**

**\* NOTICE**

Combustion seals must be compressed after installation and before attempting to install into the cylinder head. Use SST 09353 2B000 (refer to [TSB ENG083](#)).

## Dipstick Tube &amp; Dipstick:

- Prior to installing the new tube, lubricate the o-ring located at the bottom of the tube with engine oil.
- Install the red dipstick included in Service Kit I.

**Tightening torque of bolt:**

**5.8 – 8.7 lb.ft (7.8 – 11.8 N.m,  
0.8 - 1.2 kgf.m)**

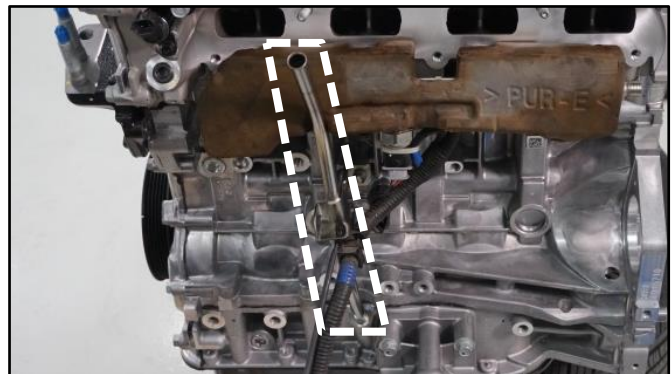

## Intake Manifold:

- Prior to installation, replace the intake manifold gaskets.
- Torque bolts in the sequence shown.

**Tightening torque of bolts:**

**13.7 – 17.4 lb.ft (18.6 – 23.5 N.m,  
1.9 – 2.4 kgf.m)**

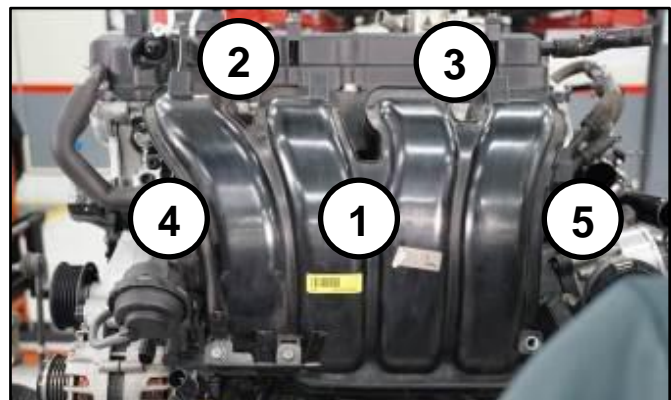

**SUBJECT: ENGINE REPLACEMENT INSTRUCTIONS FOR DTC P1326 (PI1802W/X)**

**Exhaust Manifold:**

- All engines supplied under this Product Improvement Campaign have the exhaust manifold studs configured for SULEV engines.
- Using the pictures to the right, check the exhaust manifold stud location and quantity. Relocate as required for ULEV engines and obtain one (1) extra from the removed engine.
- Prior to installation, replace the exhaust manifold gasket and front muffler gasket.
- Torque nuts in the sequence shown.

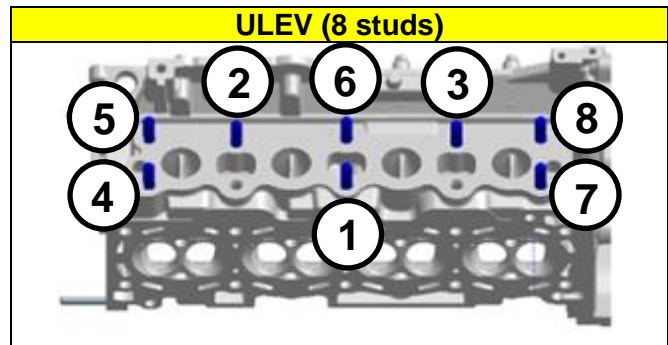
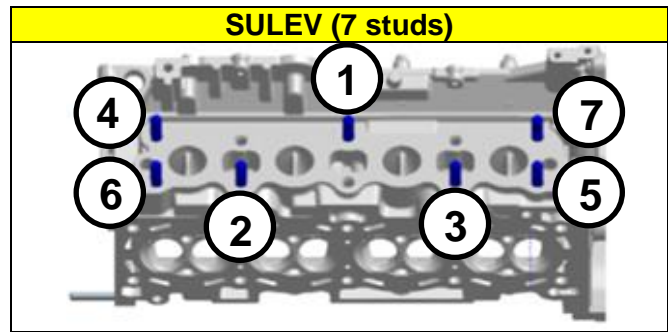

**Tightening torque of nuts:**  
**36.2 – 39.7 lb.ft (49.0 – 53.9 N.m,**  
**5.0 – 5.5 kgf.m)**

**\*For 15MY Sorento (XMa) vehicles only: check the underhood emissions label and record whether the label references ULEV or SULEV. This information is needed to select/order the correct replacement engine.**

	KIA MOTORS CORPORATION VEHICLE EMISSION CONTROL INFORMATION		
Conforms to regulations :		2015 MY	
U.S.EPA :	T2B5 LDV	OBD :	CA II Fuel : Gasoline
California :	<b>ULEV</b> PC	OBD :	CA II Fuel : Gasoline
Group :	EK36V2C4APE	DFI/HO2S(2)/WU-TWC/TWC	
Evap. :	EK36V2C130CPE	No adjustments needed.	
[WARNING]		35417-20A02	A402
Loaded I/M testing of permanent four-wheel drive or traction control-equipped vehicles must be conducted on a four-wheel drive speed synchronized dynamometer. Otherwise, a non-loaded test procedure must be performed.			

- On Turbo engines, replace the turbocharger oil feed line and gaskets.

**Tightening torque of oil feed line bolt:**  
**8.7 – 13.0 lb.ft (11.8 – 17.7 N.m,**  
**1.2 – 1.8 kgf.m)**

**Tightening torque of oil feed line nuts:**  
**5.8 – 8.7 lb.ft (7.8 – 11.8 N.m,**  
**0.8 – 1.2 kgf.m)**

**Tightening torque of oil drain line nuts and bolts:**  
**5.8 – 8.7 lb.ft (7.8 – 11.8 N.m,**  
**0.8 – 1.2 kgf.m)**

- Torque exhaust manifold nuts in the sequence shown.

**Tightening torque of nuts:**  
**36.2 – 39.7 lb.ft (49.0 – 53.9 N.m,**  
**5.0 – 5.5 kgf.m)**

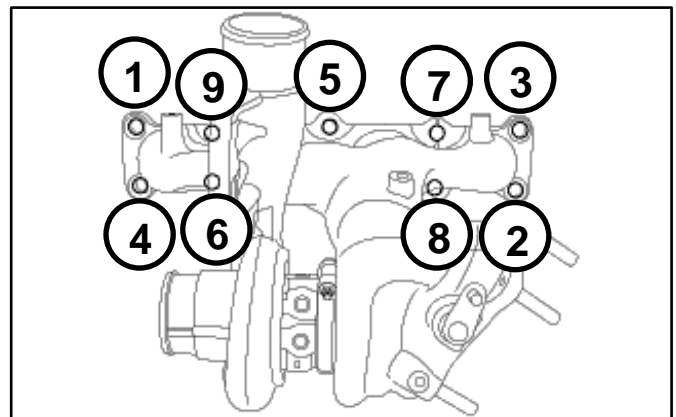

**SUBJECT: ENGINE REPLACEMENT INSTRUCTIONS FOR DTC P1326 (PI1802W/X)**
**Oil Cooler Tube Assembly:**

New engines may be supplied with a different oil cooler. Use steps below to determine the need for a replacement oil cooler tube assembly.

- If the new engine's (bigger) oil cooler (A) does not match the old engine's (smaller) oil cooler (B), replace the oil cooler tube assembly with the improved part. See parts table on page 24.
- If the new engine's (bigger) oil cooler (A) matches the old engine's (bigger) oil cooler (A), reuse the old engine's oil cooler tube assembly.
- If the new engine's (smaller) oil cooler (B) matches the old engine's (smaller) oil cooler (B), reuse the old engine's oil cooler tube assembly.

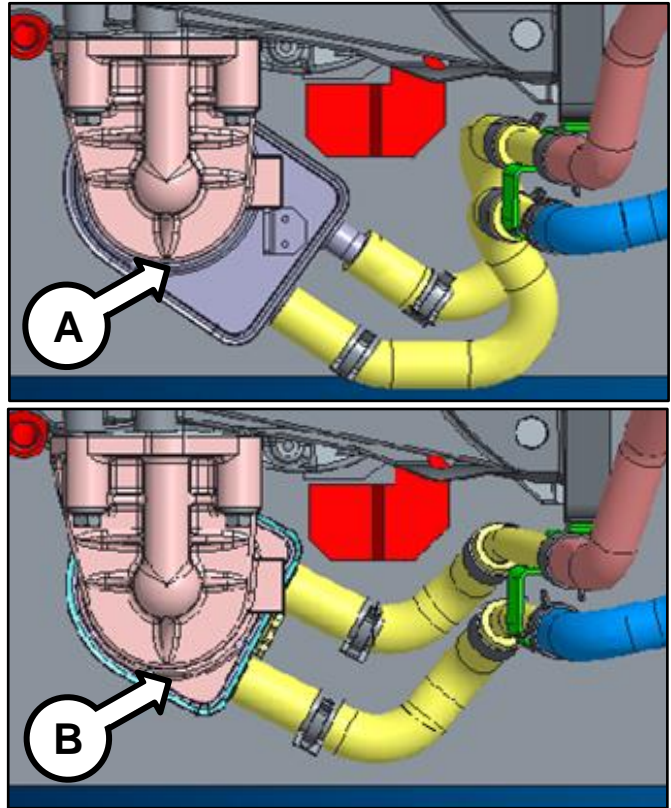
**Drive Plate Bolts:**

- Replace all seven (7) drive plate (AT) bolts.

**Tightening torque of nuts:**

**86.8 – 93.9 lb.ft (117.7 – 125.5 N.m,  
12.0 – 13.0 kgf.m)**

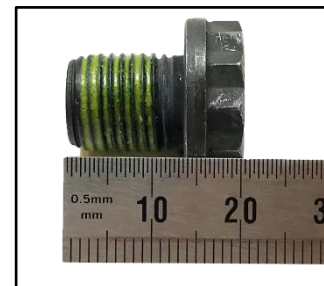

Drive Plate Bolt (A/T)

**Torque Converter**

- If the torque converter has moved from the fully inserted position, carefully push inward while rotating the torque converter until it is recessed approximately 9/16 – 5/8" (14 – 16mm) (☑) into the transaxle case when reinstalling the automatic transaxle.

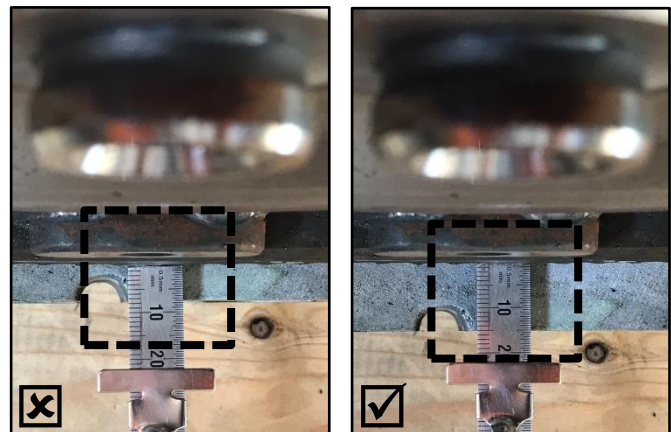

Not Fully Inserted

Fully Inserted

5. Reinstall the assembled engine and transmission/transaxle into the vehicle.

Be sure to:

- Fill crankcase with 5W-30 oil (~5.8 quarts).
- Fill and bleed the cooling system with 50/50 coolant or mixture appropriate for area.
- Pressurize the fuel system before starting the vehicle.
- Reset engine adaptive values and perform steering angle sensor calibration.

Refer to [TSB ENG190](#) for information regarding engine replacement practices.

6. Verify proper operation of the vehicle with road test, and **with the engine ON (running), erase any stored DTCs** (e.g., EPS, ESC, and TPMS) that may have been set by this procedure. Verify no leaks exist and ensure engine oil and coolant are at their proper level.





If any DTCs are still active, follow any related diagnosis and repair as needed.

**SUBJECT: ENGINE REPLACEMENT INSTRUCTIONS FOR DTC P1326 (P11802W/X)**

## AFFECTED VEHICLE RANGE:



Model	Production Date Range
14MY Optima (TF)	August 29, 2013 through April 25, 2014
15-18MY Optima (TF/QF/JF/JFa)	April 16, 2014 through July 11, 2018
14-18MY Sportage (SL/QL)	September 30, 2013 through April 5, 2018
15-18MY Sorento (XMa/UMa)	January 3, 2014 through March 7, 2018

## REQUIRED TOOL:







Tool Name	Tool Part No.	Figure	Comments
Torque Wrench Socket	09314 3Q100		Refer to <a href="#">TSB ENG083</a> for detailed usage instructions
Injector Combustion Seal Ring Installer	09353 2B000		
Pin Tool	91400 00000QQK		Auto-shipped to Dealers in 10/2018. Replacements can be ordered through Mobis Parts America.
Click-Type or Electronic Torque Wrench	N/A		Locally Sourced
Engine Noise Tester SST	GIT1XTDCP005		Auto-shipped to Dealers in June 2017 for SC147 For replacements, contact Snap-On Business Solutions at (888) 542-1011.

## REQUIRED PARTS:

Part Name	MY	Model	Part Number		Figure
			2.4L GDI	2.0L T-GDI	
Engine Long Block	14-15	TF	21101 2GK06QQKR	-	
	14-16	SL	21101 2GK36QQKR	21101 2GK37QQKR	
	15	QF	21101 2GK06QQKR	21101 2GK08QQKR	
		XMa ULEV & SULEV	21101 2GK11QQKR	-	
	17-18	QL	21101 2GK35QQKR	21101 2GK39QQKR	
	16-17	UMa	21101 2GK31QQKR	21101 2GK32QQKR	
	18		21101 2GK33QQKR		
	16-18	JF, JFa	21101 2GK34QQKR	21101 2GK32QQKR	

Models	Part Name	Engine	Part Number	Figure
TF, SL, QF, XMa	Service Kit I	2.4L GDI	21111 2GK50QQK	
		2.0L T-GDI	21111 2GK60QQK	

## SUBJECT: ENGINE REPLACEMENT INSTRUCTIONS FOR DTC P1326 (PI1802W/X)

Models	Part Name	Engine	Part Number	Figure
UMa, QL, JF, JFa	Service Kit I	2.4L GDI	21111 2GK51QQK	
		2.0L T-GDI	21111 2GK52QQK	
TF, SL, QF, XMa	Service Kit II	2.4L GDI and 2.0L T-GDI	21111 2GK70QQK	
UMa, QL, JF, JFa		2.4L GDI	21111 2GK71QQK	
		2.0L T-GDI	21111 2GK72QQK	
TF, SL, QF, XMa		KS Extension Harness	2.4L GDI and 2.0L T-GDI	*91400 2T100QQK
UMa, QL, JF, JFa	2.4L GDI and 2.0L T-GDI		91400 2T010QQK	
All	Drive Plate Bolts	2.4L GDI and 2.0L T-GDI	23311 25050	
	Oil Cooler Tube Assembly (replacement is conditional, refer to page 21)	2.4L GDI	25470 2G050QQK	
		2.0L T-GDI	25470 2G650QQK	

\*NOTE: Old part number 91400 2T000QQK has been superseded by new part number 91400 2T100QQK.



**SUBJECT: ENGINE REPLACEMENT INSTRUCTIONS FOR DTC P1326 (PI1802W/X)**

WARRANTY INFORMATION (PI1802W1, MIL ON WITH P1326):

**N Code: N99 C Code: C99**

Model	Claim Type	Causal P/N	Qty.	Repair Description	Labor Op Code	Op Time	Replacement P/N	Qty.			
Sor. (XMa) 2.4L	R	21020 2G010	0	(PI1802W1) 2.4L GDI 2WD MIL ON with P1326, KSDS Wire Harness Inspection Pass, Engine Noise Inspection Pass, & KSDS Extension Harness Install	180A12R4	1.1 M/H	*91400 2T100QQK	1			
				(PI1802W1) 2.4L GDI 2WD MIL ON with P1326, KSDS Wire Harness Inspection Pass, Engine Noise Inspection Fail, & Engine Replacement	180A12R0	8.7 M/H	21111 2GK50QQKR	1			
							21111 2GK70QQKR	1			
							23311 25050	7			
							(ULEV or SULEV) 21101 2GK11QQKR	1			
				(PI1802W1) 2.4L GDI 2WD MIL ON with P1326, KSDS Wire Harness Inspection Fail, KSDS Extension Harness Install	180A12R2	0.8 M/H	*91400 2T100QQK	1			
				(PI1802W1) 2.4L GDI AWD MIL ON with P1326, KSDS Wire Harness Inspection Pass, Engine Noise Inspection Pass, & KSDS Extension Harness Install	180A12R5	1.1 M/H	*91400 2T100QQK	1			
							(PI1802W1) 2.4L GDI AWD MIL ON with P1326, KSDS Wire Harness Inspection Pass, Engine Noise Inspection Fail, & Engine Replacement	180A12R1	8.9 M/H	21111 2GK50QQK	1
										21111 2GK70QQK	1
										23311 25050	7
(ULEV or SULEV) 21101 2GK11QQKR	1										
(PI1802W1) 2.4L GDI AWD MIL ON with P1326, KSDS Wire Harness Inspection Fail, KSDS Extension Harness Install	180A12R3	0.8 M/H	*91400 2T100QQK	1							

**\*NOTE: Old part number 91400 2T00QQK has been superseded by new part number 91400 2T100QQK.**

## SUBJECT: ENGINE REPLACEMENT INSTRUCTIONS FOR DTC P1326 (PI1802W/X)

Model	Claim Type	Causal P/N	Qty.	Repair Description	Labor Op Code	Op Time	Replacement P/N	Qty.
Opt. (QF) 2.4L	R	23060 2G400	0	(PI1802W1) 2.4L GDI MIL ON with P1326, KSDS Wire Harness Inspection Pass, Engine Noise Inspection Pass, & KSDS Extension Harness Install	180A16R5	1.1 M/H	*91400 2T100QQK	1
				(PI1802W1) 2.4L GDI MIL ON with P1326, KSDS Wire Harness Inspection Pass, Engine Noise Inspection Fail, & Engine Replacement	180A16R1	8.7 M/H	21111 2GK50QQK	1
				21111 2GK70QQK			1	
				23311 25050			7	
21101 2GK06QQKR	1							
Opt. (QF) 2.0L T	R	23060 2G400	0	(PI1802W1) 2.0L T-GDI MIL ON with P1326, KSDS Wire Harness Inspection Pass, Engine Noise Inspection Pass, & KSDS Extension Harness Install	180A16R4	1.1 M/H	*91400 2T100QQK	1
				(PI1802W1) 2.0L T-GDI MIL ON with P1326, KSDS Wire Harness Inspection Pass, Engine Noise Inspection Fail, & Engine Replacement	180A16R0	8.9 M/H	21111 2GK60QQK	1
				21111 2GK70QQK			1	
				23311 25050			7	
21101 2GK08QQKR	1							
Opt. (TF) 2.4L	R	23060 2G400	0	(PI1802W1) 2.4L GDI MIL ON with P1326, KSDS Wire Harness Inspection Pass, Engine Noise Inspection Pass, & KSDS Extension Harness Install	180111RK	1.1 M/H	*91400 2T100QQK	1
				(PI1802W1) 2.4L GDI MIL ON with P1326, KSDS Wire Harness Inspection Pass, Engine Noise Inspection Fail, & Engine Replacement	180111R0	8.7 M/H	21111 2GK50QQK	1
				21111 2GK70QQK			1	
				23311 25050			7	
21101 2GK06QQKR	1							
Opt. (TF) 2.4L	R	23060 2G400	0	(PI1802W1) 2.4L GDI MIL ON with P1326, KSDS Wire Harness Inspection Fail, KSDS Extension Harness Install	180111R5	0.8 M/H	*91400 2T100QQK	1

\*NOTE: Old part number 91400 2T00QQK has been superseded by new part number 91400 2T100QQK.

## SUBJECT: ENGINE REPLACEMENT INSTRUCTIONS FOR DTC P1326 (PI1802W/X)

Model	Claim Type	Causal P/N	Qty.	Repair Description	Labor Op Code	Op Time	Replacement P/N	Qty.			
Spo. (SL) 2.4L	R	23060 2G400	0	(PI1802W1) 2.4L GDI 2WD MIL ON with P1326, KSDS Wire Harness Inspection Pass, Engine Noise Inspection Pass, & KSDS Extension Harness Install	180112RK	1.2 M/H	*91400 2T100QQK	1			
				(PI1802W1) 2.4L GDI 2WD MIL ON with P1326, KSDS Wire Harness Inspection Pass, Engine Noise Inspection Fail, & Engine Replacement	180112R0	8.0 M/H	21111 2GK50QQK	1			
							21111 2GK70QQK	1			
							23311 25050	7			
							21101 2GK36QQKR	1			
				(PI1802W1) 2.4L GDI 2WD MIL ON with P1326, KSDS Wire Harness Inspection Fail, KSDS Extension Harness Install	180112R5	0.9 M/H	*91400 2T100QQK	1			
				(PI1802W1) 2.4L GDI AWD MIL ON with P1326, KSDS Wire Harness Inspection Pass, Engine Noise Inspection Pass, & KSDS Extension Harness Install	180112RM	1.2 M/H	*91400 2T100QQK	1			
							(PI1802W1) 2.4L GDI AWD MIL ON with P1326, KSDS Wire Harness Inspection Pass, Engine Noise Inspection Fail, & Engine Replacement	180112R2	8.4 M/H	21111 2GK50QQK	1
										21111 2GK70QQK	1
										23311 25050	7
21101 2GK36QQKR	1										
(PI1802W1) 2.4L GDI AWD MIL ON with P1326, KSDS Wire Harness Inspection Fail, KSDS Extension Harness Install	180112R7	0.9 M/H	*91400 2T100QQK				1				

\*NOTE: Old part number 91400 2T00QQK has been superseded by new part number 91400 2T10QQK.

## SUBJECT: ENGINE REPLACEMENT INSTRUCTIONS FOR DTC P1326 (PI1802W/X)

Model	Claim Type	Causal P/N	Qty.	Repair Description	Labor Op Code	Op Time	Replacement P/N	Qty.
Spo. (SL) 2.0L T	R	23060 2G400	0	(PI1802W1) 2.0L T-GDI 2WD MIL ON with P1326, KSDS Wire Harness Inspection Pass, Engine Noise Inspection Pass, & KSDS Extension Harness Install	180112RN	1.2 M/H	*91400 2T100QQK	1
				(PI1802W1) 2.0L T-GDI 2WD MIL ON with P1326, KSDS Wire Harness Inspection Pass, Engine Noise Inspection Fail, & Engine Replacement	180112R3	8.0 M/H	21111 2GK60QQK	1
				21111 2GK70QQK			1	
				23311 25050			7	
				21101 2GK37QQKR			1	
				(PI1802W1) 2.0L T-GDI 2WD MIL ON with P1326, KSDS Wire Harness Inspection Fail, KSDS Extension Harness Install	180112R8	0.9 M/H	*91400 2T100QQK	1
				(PI1802W1) 2.0L T-GDI AWD MIL ON with P1326, KSDS Wire Harness Inspection Pass, Engine Noise Inspection Pass, & KSDS Extension Harness Install	180112RO	1.2 M/H	*91400 2T100QQK	1
				(PI1802W1) 2.0L T-GDI AWD MIL ON with P1326, KSDS Wire Harness Inspection Pass, Engine Noise Inspection Fail, & Engine Replacement	180112R4	8.4 M/H	21111 2GK60QQK	1
				21111 2GK70QQK			1	
				23311 25050			7	
21101 2GK37QQKR	1							
(PI1802W1) 2.0L T-GDI AWD MIL ON with P1326, KSDS Wire Harness Inspection Fail, KSDS Extension Harness Install	180112R9	0.9 M/H	*91400 2T100QQK	1				

\*NOTE: Old part number 91400 2T000QQK has been superseded by new part number 91400 2T100QQK.

## SUBJECT: ENGINE REPLACEMENT INSTRUCTIONS FOR DTC P1326 (PI1802W/X)

Model	Claim Type	Causal P/N	Qty.	Repair Description	Labor Op Code	Op Time	Replacement P/N	Qty.
Sor. (UMa) 2.4L	R	23060 2G401	0	(PI1802W1) 2.4L GDI 2WD MIL ON with P1326, KSDS Wire Harness Inspection Pass, Engine Noise Inspection Pass, & KSDS Extension Harness Install	180A32RJ	1.1 M/H	91400 2T010QQK	1
				(PI1802W1) 2.4L GDI 2WD MIL ON with P1326, KSDS Wire Harness Inspection Pass, Engine Noise Inspection Fail, & Engine Replacement	180A32R0	8.7 M/H	21111 2GK51QQK	1
							21111 2GK71QQK	1
							23311 25050	7
							(16-17MY) 21101 2GK31QQKR	1
							(18MY) 21101 2GK33QQKR	
				(PI1802W1) 2.4L GDI 2WD MIL ON with P1326, KSDS Wire Harness Inspection Fail, KSDS Extension Harness Install	180A32R4	0.8 M/H	91400 2T010QQK	1
				(PI1802W1) 2.4L GDI AWD MIL ON with P1326, KSDS Wire Harness Inspection Pass, Engine Noise Inspection Pass, & KSDS Extension Harness Install	180A32RK	1.1 M/H	91400 2T010QQK	1
				(PI1802W1) 2.4L GDI AWD MIL ON with P1326, KSDS Wire Harness Inspection Pass, Engine Noise Inspection Fail, & Engine Replacement	180A32R1	9.0 M/H	21111 2GK51QQK	1
							21111 2GK71QQK	1
23311 25050	7							
(16-17MY) 21101 2GK31QQKR	1							
(18MY) 21101 2GK33QQKR								
(PI1802W1) 2.4L GDI AWD MIL ON with P1326, KSDS Wire Harness Inspection Fail, KSDS Extension Harness Install	180A32R5	0.8 M/H	91400 2T010QQK	1				

## SUBJECT: ENGINE REPLACEMENT INSTRUCTIONS FOR DTC P1326 (PI1802W/X)

Model	Claim Type	Causal P/N	Qty.	Repair Description	Labor Op Code	Op Time	Replacement P/N	Qty.
Sor. (UMa) 2.0L T	R	23060 2G401	0	(PI1802W1) 2.0L T-GDI 2WD MIL ON with P1326, KSDS Wire Harness Inspection Pass, Engine Noise Inspection Pass, & KSDS Extension Harness Install	180A32RL	1.1 M/H	91400 2T010QQK	1
				(PI1802W1) 2.0L T-GDI 2WD MIL ON with P1326, KSDS Wire Harness Inspection Pass, Engine Noise Inspection Fail, & Engine Replacement	180A32R2	8.7 M/H	21111 2GK52QQK	1
							21111 2GK72QQK	1
							23311 25050	7
							21101 2GK32QQKR	1
				(PI1802W1) 2.0L T-GDI 2WD MIL ON with P1326, KSDS Wire Harness Inspection Fail, KSDS Extension Harness Install	180A32R6	0.8 M/H	91400 2T010QQK	1
				(PI1802W1) 2.0L T-GDI AWD MIL ON with P1326, KSDS Wire Harness Inspection Pass, Engine Noise Inspection Pass, & KSDS Extension Harness Install	180A32RM	1.1 M/H	91400 2T010QQK	1
				(PI1802W1) 2.0L T-GDI AWD MIL ON with P1326, KSDS Wire Harness Inspection Pass, Engine Noise Inspection Fail, & Engine Replacement	180A32R3	9.0 M/H	21111 2GK52QQK	1
							21111 2GK72QQK	1
							23311 25050	7
21101 2GK32QQKR	1							
(PI1802W1) 2.0L T-GDI AWD MIL ON with P1326, KSDS Wire Harness Inspection Fail, KSDS Extension Harness Install	180A32R7	0.8 M/H	91400 2T010QQK	1				

## SUBJECT: ENGINE REPLACEMENT INSTRUCTIONS FOR DTC P1326 (PI1802W/X)

Model	Claim Type	Causal P/N	Qty.	Repair Description	Labor Op Code	Op Time	Replacement P/N	Qty.
Spo. (QL) 2.4L	R	23060 2G401	0	(PI1802W1) 2.4L GDI 2WD MIL ON with P1326, KSDS Wire Harness Inspection Pass, Engine Noise Inspection Pass, & KSDS Extension Harness Install	180114RK	1.1 M/H	91400 2T010QQK	1
				(PI1802W1) 2.4L GDI 2WD MIL ON with P1326, KSDS Wire Harness Inspection Pass, Engine Noise Inspection Fail, & Engine Replacement	180114R0	8.7 M/H	21111 2GK51QQK	1
							21111 2GK71QQK	1
							23311 25050	7
							21101 2GK35QQKR	1
				(PI1802W1) 2.4L GDI 2WD MIL ON with P1326, KSDS Wire Harness Inspection Fail, KSDS Extension Harness Install	180114R5	0.8 M/H	91400 2T010QQK	1
				(PI1802W1) 2.4L GDI AWD MIL ON with P1326, KSDS Wire Harness Inspection Pass, Engine Noise Inspection Pass, & KSDS Extension Harness Install	180114RM	1.1 M/H	91400 2T010QQK	1
				(PI1802W1) 2.4L GDI AWD MIL ON with P1326, KSDS Wire Harness Inspection Pass, Engine Noise Inspection Fail, & Engine Replacement	180114R2	9.0 M/H	21111 2GK51QQK	1
							21111 2GK71QQK	1
							23311 25050	7
21101 2GK35QQKR	1							
(PI1802W1) 2.4L GDI AWD MIL ON with P1326, KSDS Wire Harness Inspection Fail, KSDS Extension Harness Install	180114R7	0.8 M/H	91400 2T010QQK	1				

## SUBJECT: ENGINE REPLACEMENT INSTRUCTIONS FOR DTC P1326 (PI1802W/X)

Model	Claim Type	Causal P/N	Qty.	Repair Description	Labor Op Code	Op Time	Replacement P/N	Qty.
Spo. (QL) 2.0L T	R	23060 2G401	0	(PI1802W1) 2.0L T-GDI 2WD MIL ON with P1326, KSDS Wire Harness Inspection Pass, Engine Noise Inspection Pass, & KSDS Extension Harness Install	180114RN	1.1 M/H	91400 2T010QQK	1
				(PI1802W1) 2.0L T-GDI 2WD MIL ON with P1326, KSDS Wire Harness Inspection Pass, Engine Noise Inspection Fail, & Engine Replacement	180114R3	8.7 M/H	21111 2GK52QQK	1
							21111 2GK72QQK	1
							23311 25050	7
							21101 2GK39QQKR	1
				(PI1802W1) 2.0L T-GDI 2WD MIL ON with P1326, KSDS Wire Harness Inspection Fail, KSDS Extension Harness Install	180114R8	0.8 M/H	91400 2T010QQK	1
				(PI1802W1) 2.0L T-GDI AWD MIL ON with P1326, KSDS Wire Harness Inspection Pass, Engine Noise Inspection Pass, & KSDS Extension Harness Install	180114RO	1.1 M/H	91400 2T010QQK	1
				(PI1802W1) 2.0L T-GDI AWD MIL ON with P1326, KSDS Wire Harness Inspection Pass, Engine Noise Inspection Fail, & Engine Replacement	180114R4	9.0 M/H	21111 2GK52QQK	1
							21111 2GK72QQK	1
							23311 25050	7
21101 2GK39QQKR	1							
(PI1802W1) 2.0L T-GDI AWD MIL ON with P1326, KSDS Wire Harness Inspection Fail, KSDS Extension Harness Install	180114R9	0.8 M/H	91400 2T010QQK	1				



## SUBJECT: ENGINE REPLACEMENT INSTRUCTIONS FOR DTC P1326 (PI1802W/X)

Model	Claim Type	Causal P/N	Qty.	Repair Description	Labor Op Code	Op Time	Replacement P/N	Qty.
Opt. (JF) 2.4L	R	23060 2G401	0	(PI1802W1) 2.4L GDI MIL ON with P1326, KSDS Wire Harness Inspection Pass, Engine Noise Inspection Pass, & KSDS Extension Harness Install	180113RK	1.1 M/H	91400 2T010QQK	1
				(PI1802W1) 2.4L GDI MIL ON with P1326, KSDS Wire Harness Inspection Pass, Engine Noise Inspection Fail, & Engine Replacement	180113R0	8.7 M/H	21111 2GK51QQK	1
							21111 2GK71QQK	1
							23311 25050	7
21101 2GK34QQKR	1							
Opt. (JFa) 2.4L	R	23060 2G401	0	(PI1802W1) 2.4L GDI MIL ON with P1326, KSDS Wire Harness Inspection Pass, Engine Noise Inspection Pass, & KSDS Extension Harness Install	180A33R4	1.1 M/H	91400 2T010QQK	1
				(PI1802W1) 2.4L GDI MIL ON with P1326, KSDS Wire Harness Inspection Pass, Engine Noise Inspection Fail, & Engine Replacement	180A33R0	8.7 M/H	21111 2GK51QQK	1
							21111 2GK71QQK	1
							23311 25050	7
21101 2GK34QQKR	1							
Opt. (JFa) 2.0L T	R	23060 2G401	0	(PI1802W1) 2.0L T-GDI MIL ON with P1326, KSDS Wire Harness Inspection Pass, Engine Noise Inspection Pass, & KSDS Extension Harness Install	180A33R5	1.1 M/H	91400 2T010QQK	1
				(PI1802W1) 2.0L T-GDI MIL ON with P1326, KSDS Wire Harness Inspection Pass, Engine Noise Inspection Fail, & Engine Replacement	180A33R1	8.7 M/H	21111 2GK52QQK	1
							21111 2GK72QQK	1
							23311 25050	7
21101 2GK32QQKR	1							
Opt. (JFa) 2.0L T	R	23060 2G401	0	(PI1802W1) 2.0L T-GDI MIL ON with P1326, KSDS Wire Harness Inspection Fail, KSDS Extension Harness Install	180A33R3	0.8 M/H	91400 2T010QQK	1

## SUBJECT: ENGINE REPLACEMENT INSTRUCTIONS FOR DTC P1326 (PI1802W/X)

WARRANTY INFORMATION (PI1802X1, ENGINE SEIZED/SEVERE KNOCKING):

N Code: N99 C Code: C99

Model	Claim Type	Causal P/N	Qty.	Repair Description	Labor Op Code	Op Time	Replacement P/N	Qty.
Sor. (XMa) 2.4L	R	21020 2G010	0	(PI1802X1) 2.4L GDI 2WD Engine Seized / Severe Knocking, Techline Authorized Engine Replacement, KSDS Wire Harness Inspection Pass	180A12R8	8.4 M/H	21111 2GK50QQK	1
							21111 2GK70QQK	1
							23311 25050	7
							(ULEV or SULEV) 21101 2GK11QQKR	1
				(PI1802X1) 2.4L GDI 2WD Engine Seized / Severe Knocking, Techline Authorized Engine Replacement, KSDS Wire Harness Inspection Fail, KSDS Wire Harness Install	180A12RA	8.9 M/H	21111 2GK50QQK	1
							21111 2GK70QQK	1
							23311 25050	7
							(ULEV or SULEV) 21101 2GK11QQKR	1
				(PI1802X1) 2.4L GDI AWD Engine Seized / Severe Knocking, Techline Authorized Engine Replacement, KSDS Wire Harness Inspection Pass	180A12R9	8.6 M/H	21111 2GK50QQK	1
							21111 2GK70QQK	1
							23311 25050	7
							(ULEV or SULEV) 21101 2GK11QQKR	1
				(PI1802X1) 2.4L GDI AWD Engine Seized / Severe Knocking, Techline Authorized Engine Replacement, KSDS Wire Harness Inspection Fail, KSDS Wire Harness Install	180A12RB	9.1 M/H	21111 2GK50QQK	1
							21111 2GK70QQK	1
							23311 25050	7
							(ULEV or SULEV) 21101 2GK11QQKR	1
							*91400 2T100QQK	1

\*NOTE: Old part number 91400 2T00QQK has been superseded by new part number 91400 2T100QQK.

## SUBJECT: ENGINE REPLACEMENT INSTRUCTIONS FOR DTC P1326 (PI1802W/X)

Model	Claim Type	Causal P/N	Qty.	Repair Description	Labor Op Code	Op Time	Replacement P/N	Qty.
Opt. (QF) 2.4L	R	23060 2G400	0	(PI1802X1) 2.4L GDI Engine Seized / Severe Knocking, Techline Authorized Engine Replacement, KSDS Wire Harness Inspection Pass	180A16R9	8.4 M/H	21111 2GK50QQK	1
							21111 2GK70QQK	1
							23311 25050	7
							21101 2GK06QQKR	1
				(PI1802X1) 2.4L GDI Engine Seized / Severe Knocking, Techline Authorized Engine Replacement, KSDS Wire Harness Inspection Fail, KSDS Wire Harness Install	180A16RB	8.9 M/H	21111 2GK50QQK	1
							21111 2GK70QQK	1
							23311 25050	7
							21101 2GK06QQKR	1
							*91400 2T100QQK	1
Opt. (QF) 2.0L T	R	23060 2G400	0	(PI1802X1) 2.0L T-GDI Engine Seized / Severe Knocking, Techline Authorized Engine Replacement, KSDS Wire Harness Inspection Pass	180A16R8	8.7 M/H	21111 2GK60QQK	1
							21111 2GK70QQK	1
							23311 25050	7
							21101 2GK08QQKR	1
				(PI1802X1) 2.0L T-GDI Engine Seized / Severe Knocking, Techline Authorized Engine Replacement, KSDS Wire Harness Inspection Fail, KSDS Wire Harness Install	180A16RA	9.2 M/H	21111 2GK60QQK	1
							21111 2GK70QQK	1
							23311 25050	7
							21101 2GK08QQKR	1
							*91400 2T100QQK	1
Opt. (TF) 2.4L	R	23060 2G400	0	(PI1802X1) 2.4L GDI Engine Seized / Severe Knocking, Techline Authorized Engine Replacement, KSDS Wire Harness Inspection Pass	180111RA	8.4 M/H	21111 2GK50QQK	1
							21111 2GK70QQK	1
							23311 25050	7
							21101 2GK06QQKR	1
				(PI1802X1) 2.4L GDI Engine Seized / Severe Knocking, Techline Authorized Engine Replacement, KSDS Wire Harness Inspection Fail, KSDS Wire Harness Install	180111RF	8.9 M/H	21111 2GK50QQK	1
							21111 2GK70QQK	1
							23311 25050	7
							21101 2GK06QQKR	1
							*91400 2T100QQK	1

\*NOTE: Part number 91400 2T000QQK has been superseded by a new part number 91400 2T100QQK.

## SUBJECT: ENGINE REPLACEMENT INSTRUCTIONS FOR DTC P1326 (PI1802W/X)

Model	Claim Type	Causal P/N	Qty.	Repair Description	Labor Op Code	Op Time	Replacement P/N	Qty.
Spo. (SL) 2.4L	R	23060 2G400	0	(PI1802X1) 2.4L GDI 2WD Engine Seized / Severe Knocking, Techline Authorized Engine Replacement, KSDS Wire Harness Inspection Pass	180112RA	7.7 M/H	21111 2GK50QQK	1
							21111 2GK70QQK	1
							23311 25050	7
							21101 2GK36QQKR	1
				(PI1802X1) 2.4L GDI 2WD Engine Seized / Severe Knocking, Techline Authorized Engine Replacement, KSDS Wire Harness Inspection Fail, KSDS Wire Harness Install	180112RF	8.3 M/H	21111 2GK50QQK	1
							21111 2GK70QQK	1
							23311 25050	7
							21101 2GK36QQKR	1
				(PI1802X1) 2.4L GDI AWD Engine Seized / Severe Knocking, Techline Authorized Engine Replacement, KSDS Wire Harness Inspection Pass	180112RC	8.1 M/H	21111 2GK50QQK	1
							21111 2GK70QQK	1
							23311 25050	7
							21101 2GK36QQKR	1
				(PI1802X1) 2.4L GDI AWD Engine Seized / Severe Knocking, Techline Authorized Engine Replacement, KSDS Wire Harness Inspection Fail, KSDS Wire Harness Install	180112RH	8.7 M/H	21111 2GK50QQK	1
							21111 2GK70QQK	1
							23311 25050	7
							21101 2GK36QQKR	1
Spo. (SL) 2.0L T	R	23060 2G400	0	(PI1802X1) 2.0L T-GDI 2WD Engine Seized / Severe Knocking, Techline Authorized Engine Replacement, KSDS Wire Harness Inspection Pass	180112RD	7.7 M/H	21111 2GK60QQK	1
							21111 2GK70QQK	1
							23311 25050	7
							21101 2GK37QQKR	1
				(PI1802X1) 2.0L T-GDI 2WD Engine Seized / Severe Knocking, Techline Authorized Engine Replacement, KSDS Wire Harness Inspection Fail, KSDS Wire Harness Install	180112RI	8.3 M/H	21111 2GK60QQK	1
							21111 2GK70QQK	1
							23311 25050	7
							21101 2GK37QQKR	1
				(PI1802X1) 2.0L T-GDI AWD Engine Seized / Severe Knocking, Techline Authorized Engine Replacement, KSDS Wire Harness Inspection Pass	180112RE	8.1 M/H	21111 2GK60QQK	1
							21111 2GK70QQK	1
							23311 25050	7
							21101 2GK37QQKR	1
				(PI1802X1) 2.0L T-GDI AWD Engine Seized / Severe Knocking, Techline Authorized Engine Replacement, KSDS Wire Harness Inspection Fail, KSDS Wire Harness Install	180112RJ	8.7 M/H	21111 2GK60QQK	1
							21111 2GK70QQK	1
							23311 25050	7
							21101 2GK37QQKR	1
							*91400 2T100QQK	1

\*NOTE: Old part number 91400 2T000QQK has been superseded by new part number 91400 2T100QQK.

## SUBJECT: ENGINE REPLACEMENT INSTRUCTIONS FOR DTC P1326 (P11802W/X)

Model	Claim Type	Causal P/N	Qty.	Repair Description	Labor Op Code	Op Time	Replacement P/N	Qty.				
Sor. (UMa) 2.4L	R	23060 2G401	0	(P11802X1) 2.4L GDI 2WD Engine Seized / Severe Knocking, Techline Authorized Engine Replacement, KSDS Wire Harness Inspection Pass	180A32RA	8.4 M/H	21111 2GK51QQK	1				
							21111 2GK71QQK	1				
							23311 25050	7				
							(16-17MY) 21101 2GK31QQKR	1				
							(18MY) 21101 2GK33QQKR					
				(P11802X1) 2.4L GDI 2WD Engine Seized / Severe Knocking, Techline Authorized Engine Replacement, KSDS Wire Harness Inspection Fail, KSDS Wire Harness Install	180A32RB	8.9 M/H	21111 2GK51QQK	1				
							21111 2GK71QQK	1				
							23311 25050	7				
							(16-17MY) 21101 2GK31QQKR	1				
							(18MY) 21101 2GK33QQKR					
				(P11802X1) 2.4L GDI AWD Engine Seized / Severe Knocking, Techline Authorized Engine Replacement, KSDS Wire Harness Inspection Pass	180A32RE	8.7 M/H	21111 2GK51QQK	1				
							21111 2GK71QQK	1				
							23311 25050	7				
							(16-17MY) 21101 2GK31QQKR	1				
							(18MY) 21101 2GK33QQKR					
				(P11802X1) 2.4L GDI AWD Engine Seized / Severe Knocking, Techline Authorized Engine Replacement, KSDS Wire Harness Inspection Fail, KSDS Wire Harness Install	180A32RF	9.2 M/H	21111 2GK51QQK	1				
							21111 2GK71QQK	1				
							23311 25050	7				
							(16-17MY) 21101 2GK31QQKR	1				
							(18MY) 21101 2GK33QQKR					
Sor. (UMa) 2.0L T	R	23060 2G401	0	(P11802X1) 2.0L T-GDI 2WD Engine Seized / Severe Knocking, Techline Authorized Engine Replacement, KSDS Wire Harness Inspection Pass	180A32RC	8.4 M/H	21111 2GK52QQK	1				
							21111 2GK72QQK	1				
							23311 25050	7				
							21101 2GK32QQKR	1				
				(P11802X1) 2.0L T-GDI 2WD Engine Seized / Severe Knocking, Techline Authorized Engine Replacement, KSDS Wire Harness Inspection Fail, KSDS Wire Harness Install	180A32RD	8.9 M/H	21111 2GK52QQK	1				
							21111 2GK72QQK	1				
							23311 25050	7				
							21101 2GK32QQKR	1				
				(P11802X1) 2.0L T-GDI AWD Engine Seized / Severe Knocking, Techline Authorized Engine Replacement, KSDS Wire Harness Inspection Pass	180A32RG	8.7 M/H	21111 2GK52QQK	1				
							21111 2GK72QQK	1				
							23311 25050	7				
							21101 2GK32QQKR	1				
				(P11802X1) 2.0L T-GDI AWD Engine Seized / Severe Knocking, Techline Authorized Engine Replacement, KSDS Wire Harness Inspection Fail, KSDS Wire Harness Install	180A32RH	9.2 M/H	21111 2GK52QQK	1				
							21111 2GK72QQK	1				
							23311 25050	7				
							21101 2GK32QQKR	1				
											91400 2T010QQK	1

## SUBJECT: ENGINE REPLACEMENT INSTRUCTIONS FOR DTC P1326 (PI1802W/X)

Model	Claim Type	Causal P/N	Qty.	Repair Description	Labor Op Code	Op Time	Replacement P/N	Qty.
Spo. (QL) 2.4L	R	23060 2G401	0	(PI1802X1) 2.4L GDI 2WD Engine Seized / Severe Knocking, Techline Authorized Engine Replacement, KSDS Wire Harness Inspection Pass	180114RA	8.4 M/H	21111 2GK51QQK	1
							21111 2GK71QQK	1
							23311 25050	7
							21101 2GK35QQKR	1
				(PI1802X1) 2.4L GDI 2WD Engine Seized / Severe Knocking, Techline Authorized Engine Replacement, KSDS Wire Harness Inspection Fail, KSDS Wire Harness Install	180114RF	8.9 M/H	21111 2GK51QQK	1
							21111 2GK71QQK	1
							23311 25050	7
							21101 2GK35QQKR	1
				(PI1802X1) 2.4L GDI AWD Engine Seized / Severe Knocking, Techline Authorized Engine Replacement, KSDS Wire Harness Inspection Pass	180114RC	8.7 M/H	21111 2GK51QQK	1
							21111 2GK71QQK	1
							23311 25050	7
							21101 2GK35QQKR	1
				(PI1802X1) 2.4L GDI AWD Engine Seized / Severe Knocking, Techline Authorized Engine Replacement, KSDS Wire Harness Inspection Fail, KSDS Wire Harness Install	180114RH	9.2 M/H	21111 2GK51QQK	1
							21111 2GK71QQK	1
							23311 25050	7
							21101 2GK35QQKR	1
Spo. (QL) 2.0L T	R	23060 2G401	0	(PI1802X1) 2.0L T-GDI 2WD Engine Seized / Severe Knocking, Techline Authorized Engine Replacement, KSDS Wire Harness Inspection Pass	180114RD	8.4 M/H	21111 2GK52QQK	1
							21111 2GK72QQK	1
							23311 25050	7
							21101 2GK39QQKR	1
				(PI1802X1) 2.0L T-GDI 2WD Engine Seized / Severe Knocking, Techline Authorized Engine Replacement, KSDS Wire Harness Inspection Fail, KSDS Wire Harness Install	180114RI	8.9 M/H	21111 2GK52QQK	1
							21111 2GK72QQK	1
							23311 25050	7
							21101 2GK39QQKR	1
				(PI1802X1) 2.0L T-GDI AWD Engine Seized / Severe Knocking, Techline Authorized Engine Replacement, KSDS Wire Harness Inspection Pass	180114RE	8.7 M/H	21111 2GK52QQK	1
							21111 2GK72QQK	1
							23311 25050	7
							21101 2GK39QQKR	1
				(PI1802X1) 2.0L T-GDI AWD Engine Seized / Severe Knocking, Techline Authorized Engine Replacement, KSDS Wire Harness Inspection Fail, KSDS Wire Harness Install	180114RJ	9.2 M/H	21111 2GK52QQK	1
							21111 2GK72QQK	1
							23311 25050	7
							21101 2GK39QQKR	1
							91400 2T010QQK	1

## SUBJECT: ENGINE REPLACEMENT INSTRUCTIONS FOR DTC P1326 (P11802W/X)

Model	Claim Type	Causal P/N	Qty.	Repair Description	Labor Op Code	Op Time	Replacement P/N	Qty.
Opt. (JF) 2.4L	R	23060 2G401	0	(P11802X1) 2.4L GDI Engine Seized / Severe Knocking, Techline Authorized Engine Replacement, KSDS Wire Harness Inspection Pass	180113RA	8.4 M/H	21111 2GK51QQK	1
							21111 2GK71QQK	1
							23311 25050	7
							21101 2GK34QQKR	1
				(P11802X1) 2.4L GDI Engine Seized / Severe Knocking, Techline Authorized Engine Replacement, KSDS Wire Harness Inspection Fail, KSDS Wire Harness Install	180113RF	8.9 M/H	21111 2GK51QQK	1
							21111 2GK71QQK	1
							23311 25050	7
							21101 2GK34QQKR	1
Opt. (JFa) 2.4L	R	23060 2G401	0	(P11802X1) 2.4L GDI Engine Seized / Severe Knocking, Techline Authorized Engine Replacement, KSDS Wire Harness Inspection Pass	180A33RA	8.4 M/H	21111 2GK51QQK	1
							21111 2GK71QQK	1
							23311 25050	7
							21101 2GK34QQKR	1
				(P11802X1) 2.4L GDI Engine Seized / Severe Knocking, Techline Authorized Engine Replacement, KSDS Wire Harness Inspection Fail, KSDS Wire Harness Install	180A33RB	8.9 M/H	21111 2GK51QQK	1
							21111 2GK71QQK	1
							23311 25050	7
							21101 2GK34QQKR	1
Opt. (JFa) 2.0L T	R	23060 2G401	0	(P11802X1) 2.0L T-GDI Engine Seized / Severe Knocking, Techline Authorized Engine Replacement, KSDS Wire Harness Inspection Pass	180A33RC	8.7 M/H	21111 2GK52QQK	1
							21111 2GK72QQK	1
							23311 25050	7
							21101 2GK32QQKR	1
				(P11802X1) 2.0L T-GDI Engine Seized / Severe Knocking, Techline Authorized Engine Replacement, KSDS Wire Harness Inspection Fail, KSDS Wire Harness Install	180A33RD	9.2 M/H	21111 2GK52QQK	1
							21111 2GK72QQK	1
							23311 25050	7
							21101 2GK32QQKR	1
							91400 2T010QQK	1

NOTE: Refer to [Warranty Bulletin 2018-10](#) for details regarding coolant and substitute transportation reimbursement requirements.

Old part number 91400 2T000QQK has been superseded by new part number 91400 2T100QQK. See [Parts Bulletin 91-914 0003](#) for details.

Use sublet code 'X3' with a maximum allowed amount of \$19.80 for "ENGINE R&R" engine oil reimbursement.

If the replacement of the Oil Cooler Tube Assembly was required, please manually enter the applicable Oil Cooler Tube Assembly part number to the claim's related parts section.

Dispose of old parts in accordance with local, state, and Federal regulations.

## \* NOTICE

VIN inquiry data for this repair is provided for tracking purposes only. Kia retailers should reference **P11802W/X\*** when accessing the WebDCS system.

## Appendix 1 (Warranty Claim Authorization)

Scenario		Description	Action Required
1	Campaign - TSB # PI1802W/X Case for Warranty Authorization <b>NO INSPECTION</b>	Wiring Signal Interference Check cannot be completed due to engine seizure or other engine failure (won't run long enough to complete the test)	<p><b>TL PWA required for all dealers – Video of condition and WRTY143 form required*</b></p> <p>Video requirement examples below are for illustration purposes, individual requirements will vary based upon the condition reported:</p> <ul style="list-style-type: none"> <li>• Video should be continuous and show the VIN (most convenient VIN plate) and pan to show the engine condition</li> <li>• For engine seizures, attempt to turn over engine with breaker bar in video</li> <li>• For hole in engine block, show hole in video</li> </ul>

## Appendix 2 (Video Capture & Upload)

Capturing a video is often helpful in assisting the Kia Techline Agent in determining a proper diagnosis strategy. Once a TechLine case is open, the following procedure will guide you through the video capture and upload.

The Chrome™  browser should be used to access the Techline portal. Follow the steps below to clear the default browser if it is other than Chrome™.

### For KDS Tab 10.1 Tablets:

1. Select “Settings” from the App Screen.
2. Select the “General” tab at the top.
3. Select “Default Applications”.
4. If “Internet” is the default browser, select the CLEAR button.  
If “Chrome” is the default browser, further action is not required.

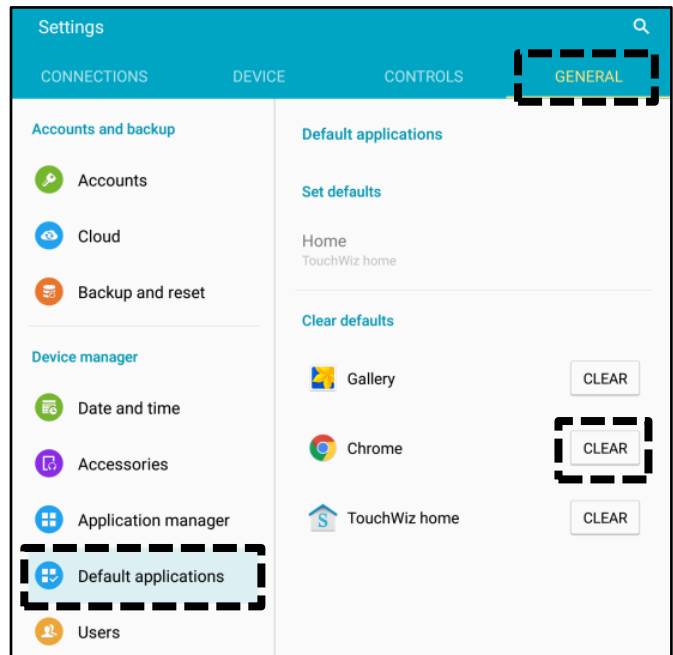

5. When opening the Techline portal, select “Chrome” and select Always”.

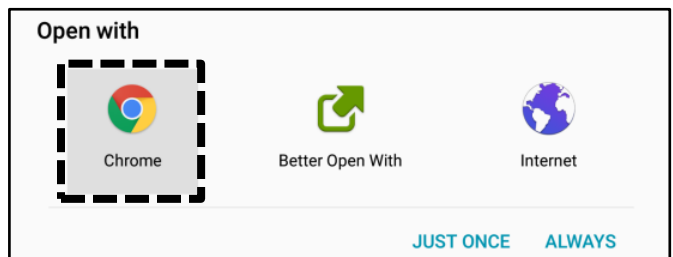



**SUBJECT: ENGINE REPLACEMENT INSTRUCTIONS FOR DTC P1326 (P11802W/X)****For KDS Tab S2 Tablets:**

1. Select “Settings” from the App Screen.
2. Select “Applications”.
3. Select “Default Applications”.

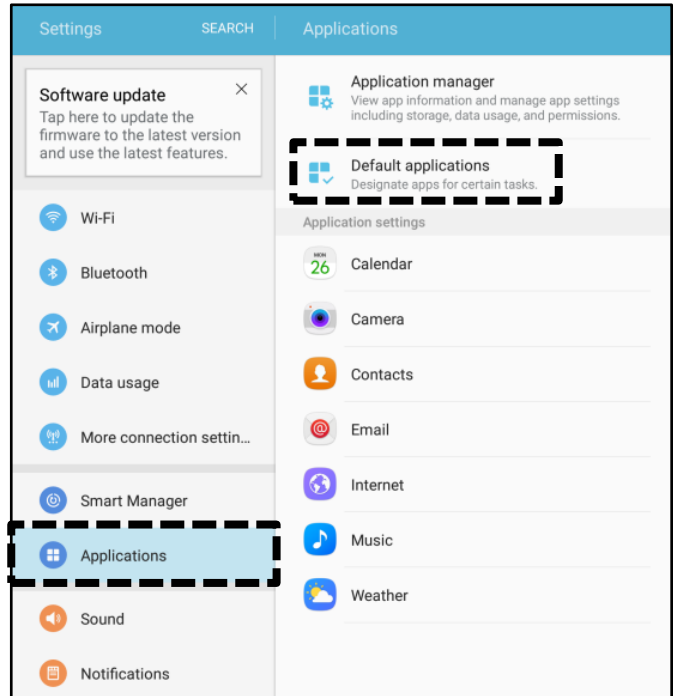

4. Select “Browser app”.

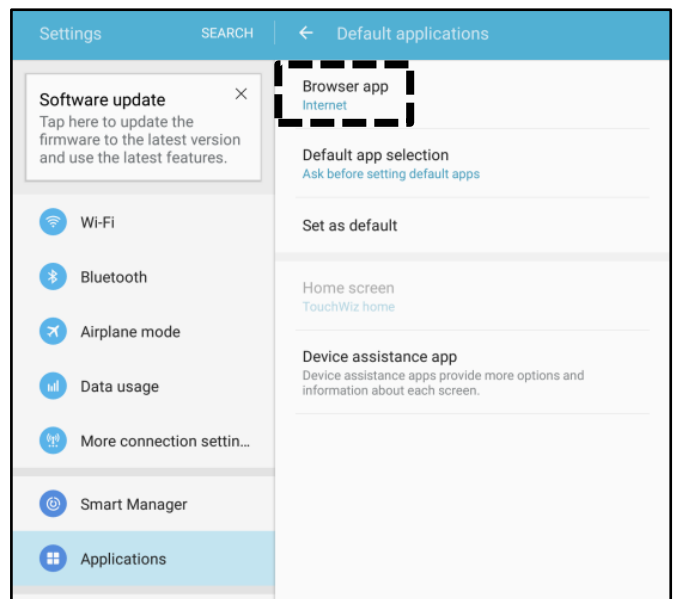

5. Ensure “Chrome” is selected.

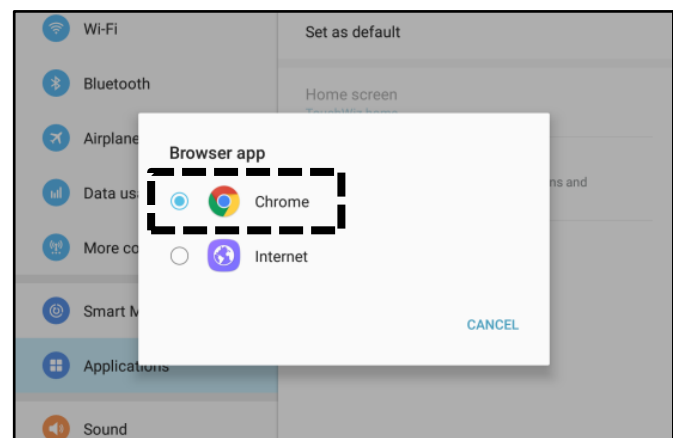

### Setting Your Video Size to “Limit to Email”

1. Select “Camera” from the App Screen.

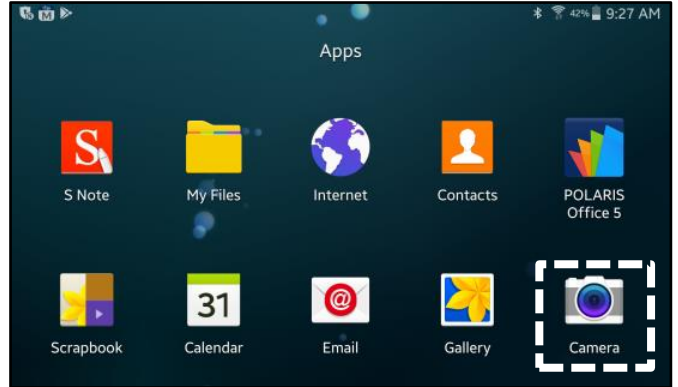

2. Select the Settings icon.

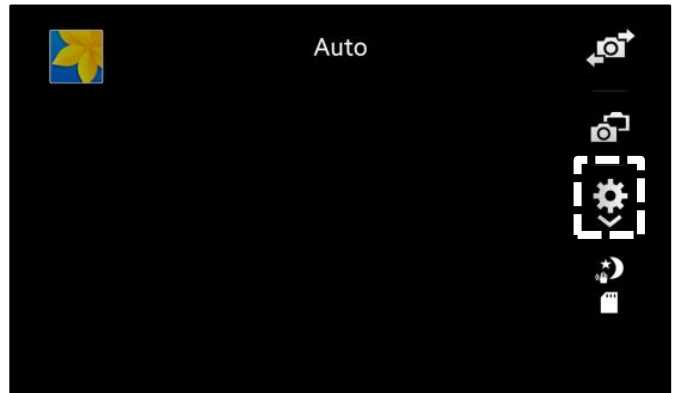

3. Select the Video Camera icon.



4. Ensure “Limit to email” is selected.

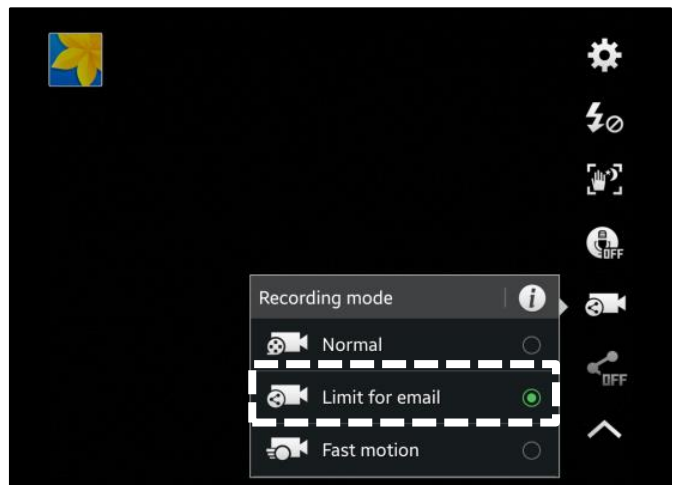

**SUBJECT: ENGINE REPLACEMENT INSTRUCTIONS FOR DTC P1326 (P11802W/X)**

**Attaching Video to a Techline Case**

1. Open K-Support in the device Chrome™ browser or select the “Techline” button on KDS home page.

<https://ksupport.kiausa.com>



2. Open your existing Techline case for the vehicle requiring a video capture by selecting the case number.

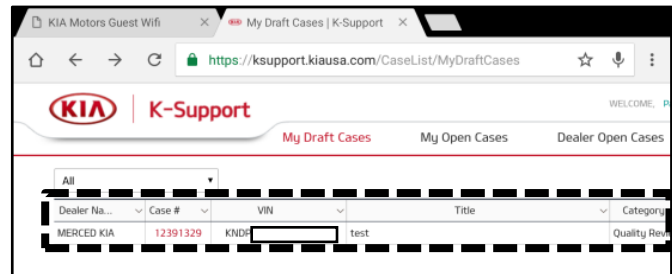

3. Select “Attachment”.

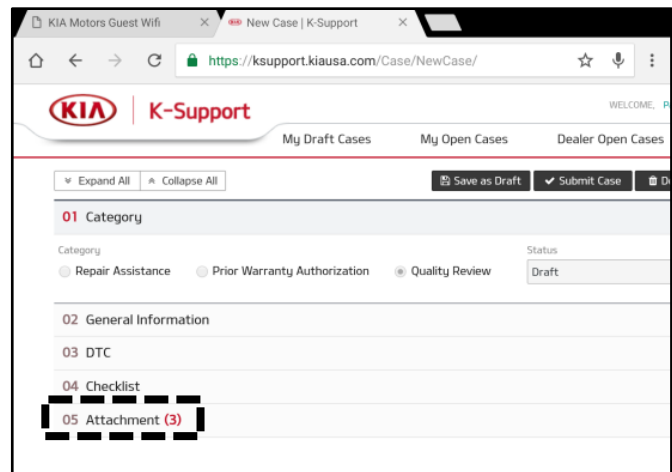

4. Select “Add Files”.

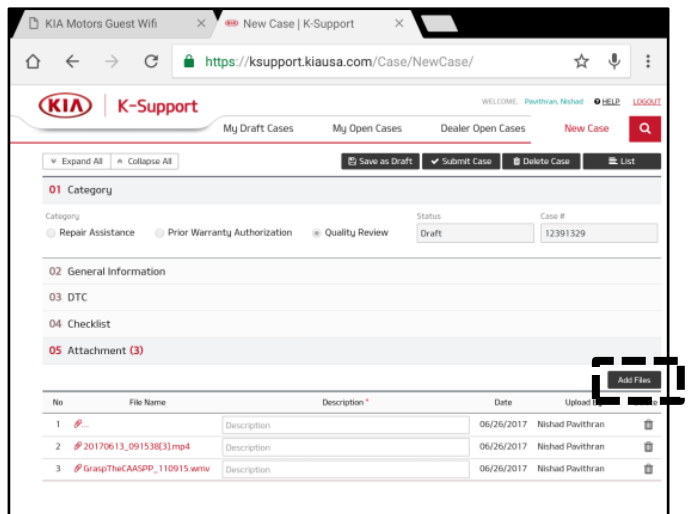

5. Select “Camcorder” and the video camera will open.

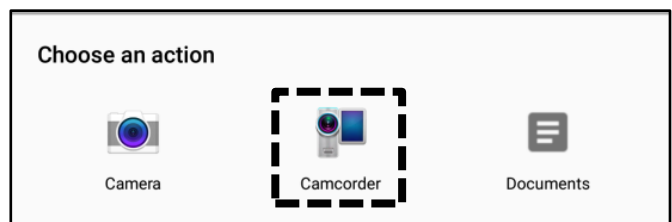

**SUBJECT: ENGINE REPLACEMENT INSTRUCTIONS FOR DTC P1326 (PI1802W/X)**

- Start by recording the VIN. Ensure sun glare is not reflecting off windows or other objects.

Without stopping the recording, capture the area of the vehicle displaying the issue. i.e.;

- Engine Noise – record the engine.
- Hole In Block – record the side of the engine with the damage.
- Seized Engine – record a technician trying to turn the engine over with a breaker bar.

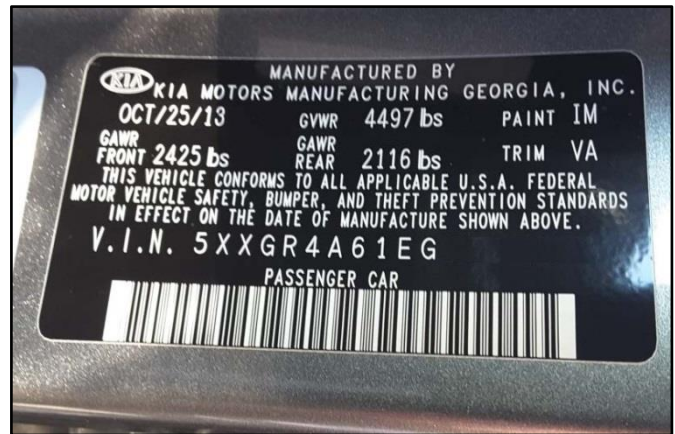

**\* NOTICE**

**NOTE: Ensure the video size is set to “Limit to email” (see page 4). Only record the VIN and the engine exhibiting the concern. Any additional information will increase the size of the video and make it difficult to upload or download.**

- Stop the video when you captured what is needed. Select “OK” to use this capture or “RETRY” to capture the video again.
- Ensure a description of the recording. For example, engine knock or smoke from exhaust.
- Select “Submit Case”.

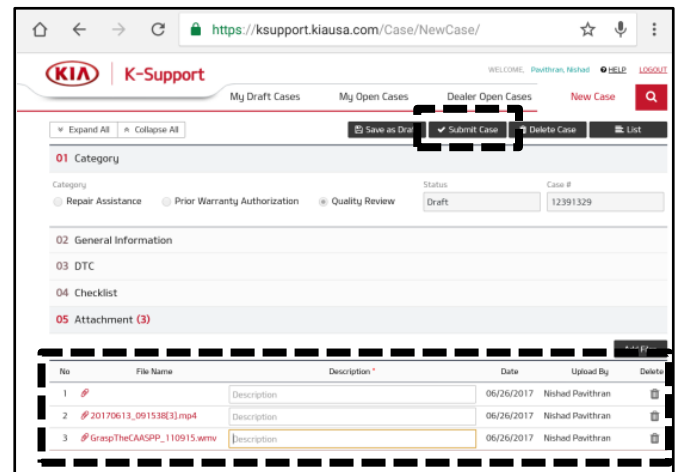

- Select “Yes” when the confirmation message below appears.

**Note: Selecting anything other than “Yes” will not save the video capture.**

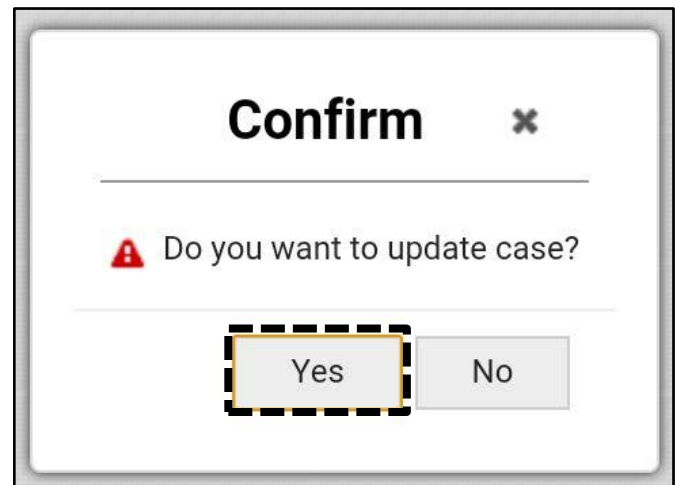

## Appendix 3 (Engine Noise Adapter Threshold)

Code	Concern	Action
RETEST Code 001	Any measured value out of range / below lower limit	Contact GIT America
RETEST Code 002	Any measured value out of range / over upper limit	Contact GIT America
RETEST Code 003	Difference between minimum and maximum of 2000 RPM <u>or</u> Idle RPM measured value out of range	Perform Retest three (3) more times. If Error Code 003 still displays after the third attempt, contact GIT America.
RETEST Code 004	Difference between minimum and maximum of 2000 RPM <u>and</u> Idle RPM measured value out of range	Perform Retest three (3) more times. If Error Code 004 still displays after the third attempt, contact GIT America.
RETEST Code 005	The adapter/extension cable is unplugged or damaged after test started	Perform Retest three (3) more times. If Error Code 005 still displays after the third attempt, contact GIT America.

GIT America can be contacted at (888) 542-4371.