



SERVICE BULLETIN

Classification: AT16-001L	Reference: NTB16-110L	Date: February 4, 2019
------------------------------	--------------------------	---------------------------

2013-2017 ALTIMA AND 2014-2017 ROGUE; 4 CYLINDER WITH DTC P17F0, P17F1, P0776, P2813, P1715, AND/OR P0841 STORED

This bulletin has been amended. See AMENDMENT HISTORY on the last page. Please discard previous versions of this bulletin.

APPLIED VEHICLES: 2013-2017 Altima (L33)
2014-2017 Rogue (T32)
APPLIED ENGINE: QR25DE (4 cylinder only)

IF YOU CONFIRM

Any combination of the following DTCs:

P0776, P2813, P0841, P17F0, P17F1, P1715

IMPORTANT:

- If DTCs are stored other than those listed above, this bulletin **does not apply**.
- If customer complains of engine stall while going from 'P' or 'N' range to 'R' or 'D' range, this bulletin **does not apply**.
- If only combinations of the judder DTCs P17F0 and P17F1 exist with no customer complaint, this bulletin **does not apply**.
- If only P1715 exists with no other DTCs, this bulletin **does not apply**.
- NTB15-083, **Enhanced Diagnostic Logic For CVT Judder**, has reprogramming instructions that may apply.

ACTION

See Repair Flow Chart on page 2 to confirm if this bulletin applies.

NOTE: Pages 59, 85 and 95 must be printed and attached to the repair order.

Nissan Bulletins are intended for use by qualified technicians, not 'do-it-yourselfers'. Qualified technicians are properly trained individuals who have the equipment, tools, safety instruction, and know-how to do a job properly and safely. NOTE: If you believe that a described condition may apply to a particular vehicle, DO NOT assume that it does. See your Nissan dealer to determine if this applies to your vehicle.

Repair Flow Chart

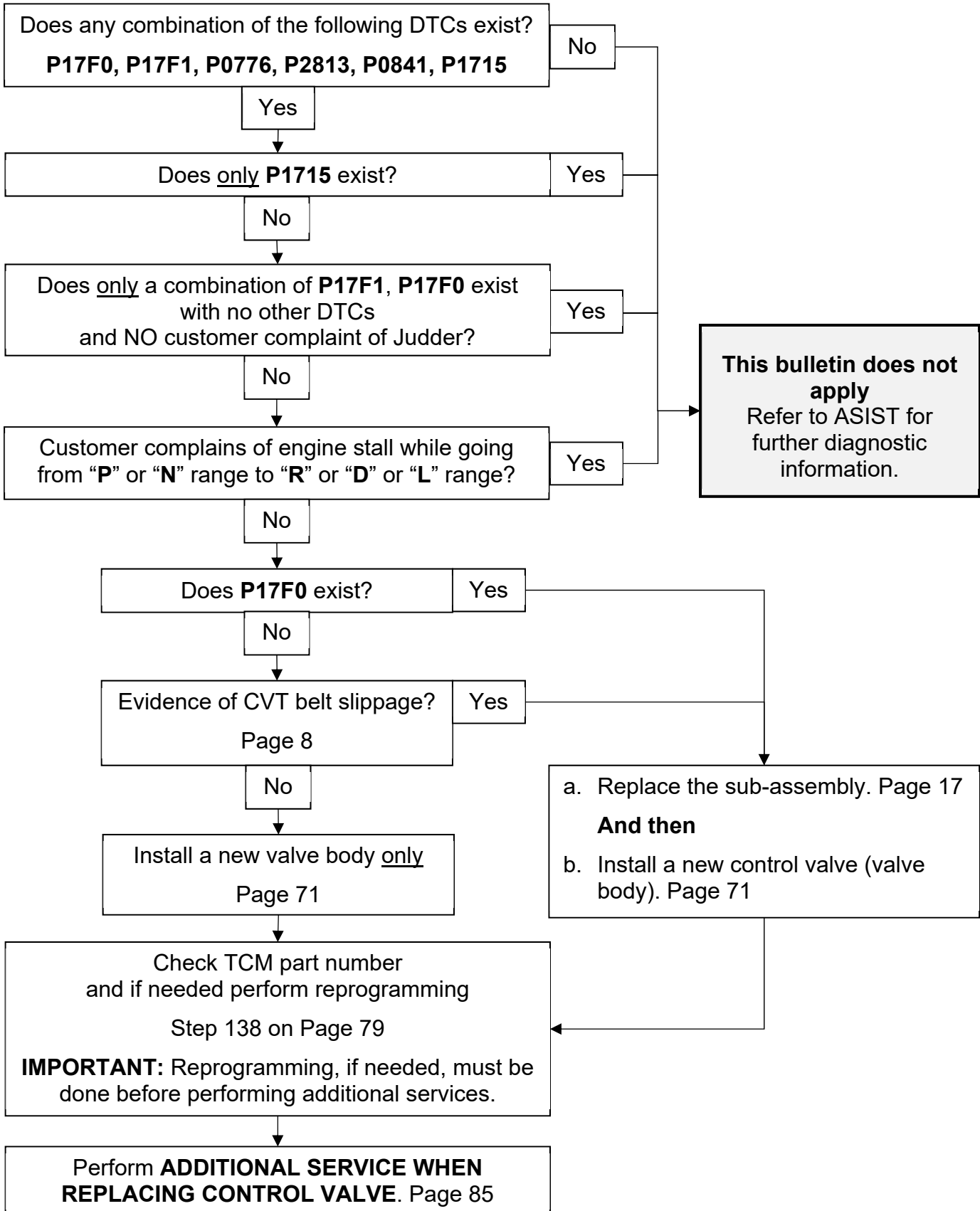

Table of Contents

• Required Tools / Material.....	page 4
• Essential Tools.....	page 4
• Weights.....	page 6
• Precautions when Disassembling a CVT Assembly.....	page 7
• Control Valve (Valve Body) Removal and CVT Belt Inspection.....	page 8
• CVT Assembly Removal.....	page 17
• Remove the Converter Housing, Oil Seals, Oil Pump Cover, Oil Pump and Oil Filter.....	page 20
• Clean the CVT case surfaces.....	page 28
• Clean the Oil Passages in the CVT Case, Oil Pump Cover, and CVT Filter Area.....	page 29
• New Oil Pump Installation.....	page 31
• Replace the Side Cover – Pulleys and Belt (sub-assembly).....	page 33
• Clutch Total Endplay Adjustment – Thrust Bearing Selection.....	page 56
• Clean the Converter Housing Passages.....	page 61
• CVT Reassembly.....	page 63
• Control Valve (Valve Body) Strainer and Pan Installation.....	page 71
• Install the CVT Assembly.....	page 77
• TCM Reprogramming.....	page 78
• Perform ADDITIONAL SERVICE WHEN REPLACING CONTROL VALVE.....	page 85
• Trouble Shooting.....	page 90
• PARTS INFORMATION.....	page 92
• CLAIMS INFORMATION.....	page 93
• PARTS KITS REFERENCE TABLE.....	page 95

Required Tools / Materials

- Cherry picker / engine hoist / lifting arm (never handle replacement CVT sub-assembly by hand)
- Strap or chain to lift and lower CVT and sub-assembly
- Petroleum jelly or equivalent
- Extendable magnet
- Large clean surface / 1 to 2 work tables
- Vernier calipers
- Brake cleaner
- Rubbing alcohol
- Plastic scraper

Essential Tools

Additional Essential Tools are available from Tech•Mate online: www.nissantechmate.com, or by phone: 1-800-662-2001.

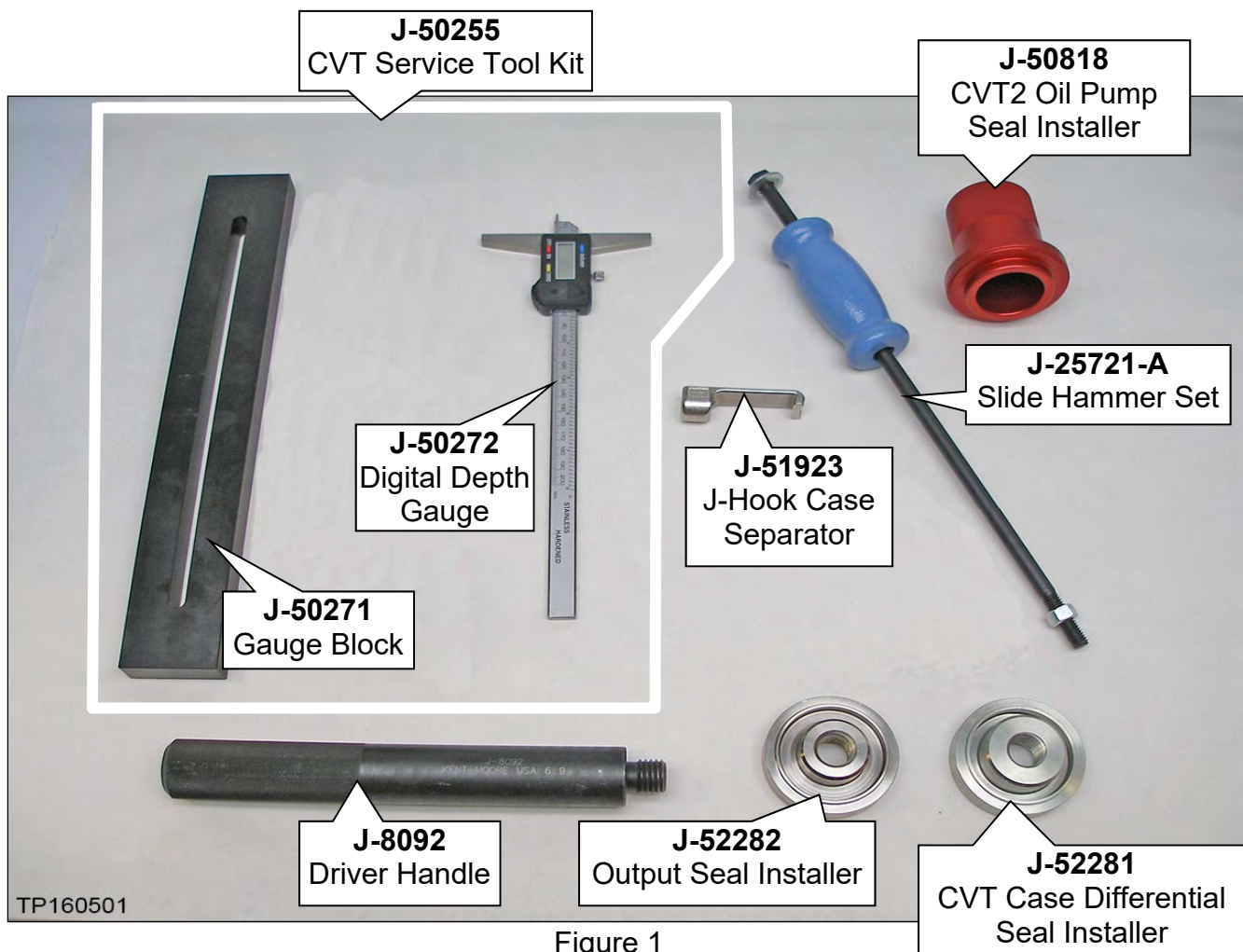

Figure 1

Essential Tools (continued). Tools that are not indicated as specifically for one model are used for all models.



Figure 2

J-51959
Guide Pins

CAUTION: Always handle the CVT and component assemblies carefully and with the appropriate lifting tools.

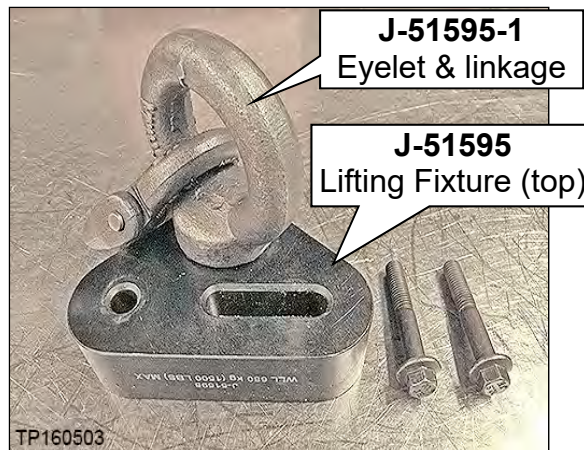
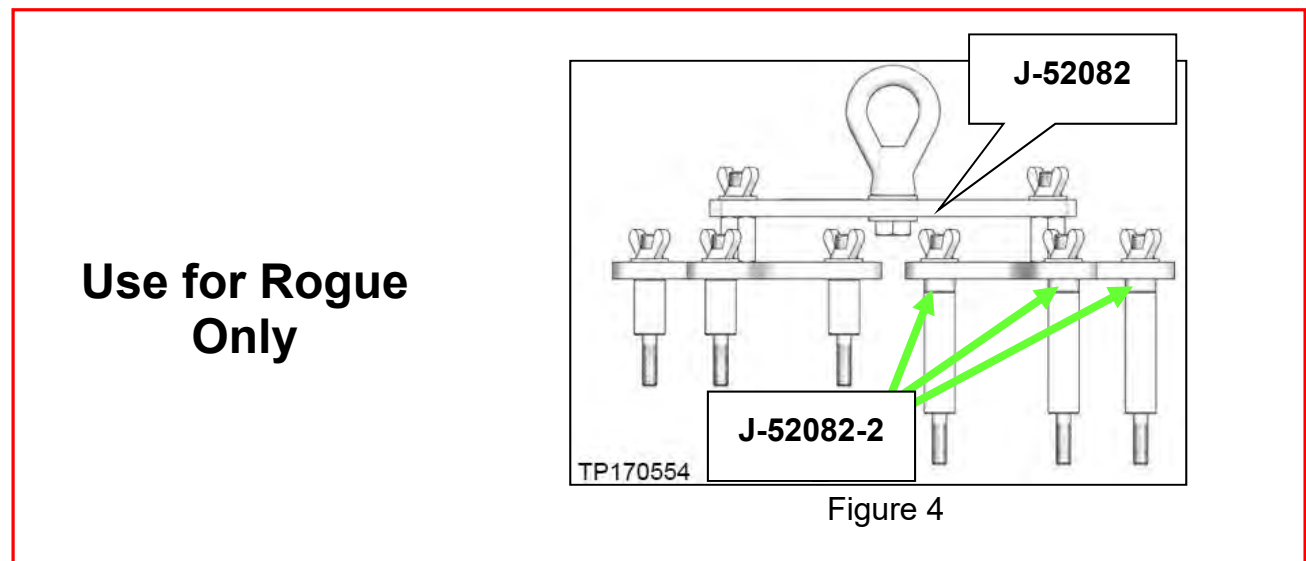

Figure 3



**Use for Rogue
Only**

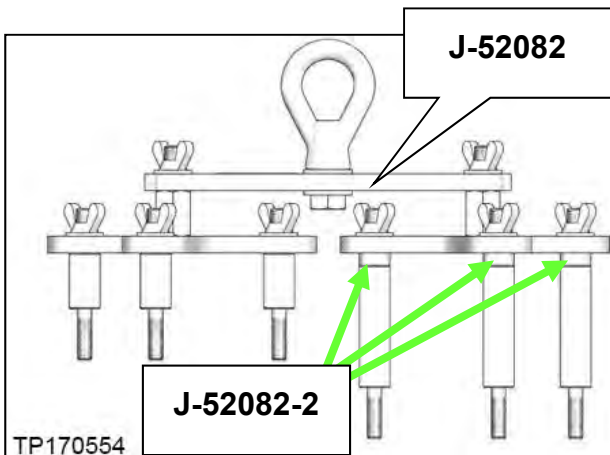
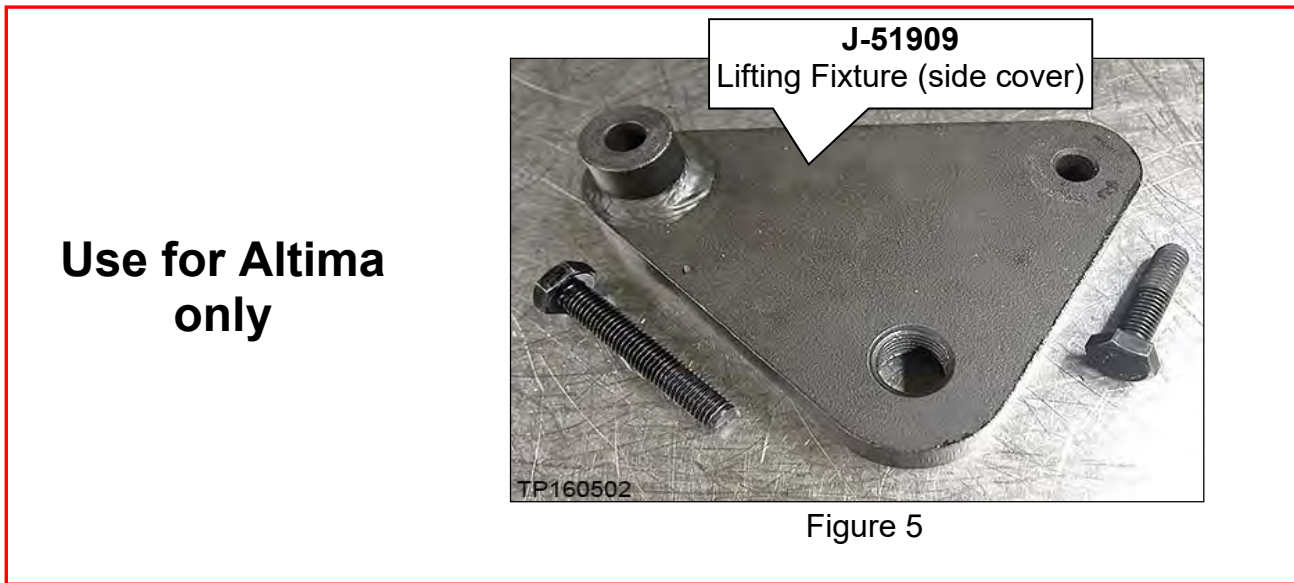

Figure 4

Essential Tools (continued)

CAUTION: Always handle the CVT and component assemblies carefully and with the appropriate lifting tools.



Tech Cam J-51951

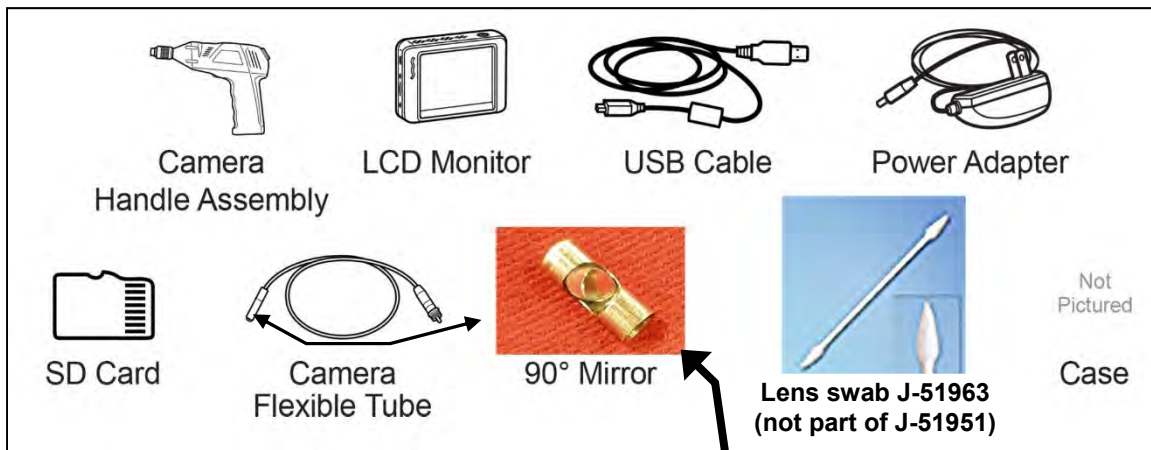

Figure 6

Remove protective film before first use

- Additional Tech Cam J-51951 kits or components are available from Tech•Mate.

Weights

- CVT assembly: 300 lbs. approximately
- CVT sub-assembly: 65 lbs. approximately

SERVICE PROCEDURE

IMPORTANT: Repairs performed for this bulletin require CONSULT-III plus Diagnostic result reporting function-Setting be turned ON and Diagnosis (All Systems) be performed. If not done, it may result in a repair being non-warrantable.

Precautions when Disassembling a CVT Assembly

Transmissions are vulnerable to particles (dust, metal, lint, etc.).

When disassembling a CVT, make sure your work environment (shop, workbench, etc.), transmission area (sub-frame, oil pan, harness connector, etc.), and your hands are free of contamination.

IMPORTANT:

- Wash and clean the exterior of the CVT assembly prior to disassembling.
CAUTION: Cover all air breather and drive shaft holes to prevent water intrusion.
- Apply rust penetrant to locator / dowel pins on torque converter housing and side cover of CVT and allow to soak as needed.
- Refrigerating oil seals may help in assembly (axle and T/C seals).
- Only disassemble those parts which are mentioned in this bulletin.
- Make sure all parts are clean prior to assembling / installing.
 - Unpack service parts just before installation.

- Store the related parts that have been removed separately to prevent being mixed up; small cups can be used.



Figure 7

IMPORTANT: The CVT unit “wiring harness connector” will be reused during this procedure. The wiring harness can be disconnected from the valve body at the wiring harness connector and remain in the CVT.

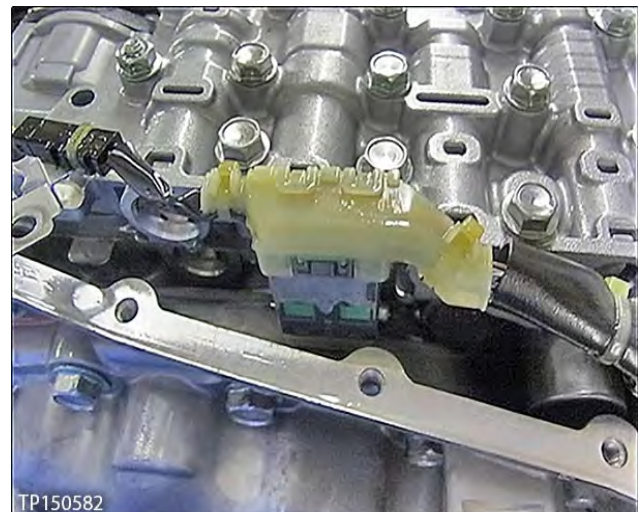

Figure 8

Control Valve (Valve Body) Removal and CVT Belt Inspection

1. Write down all radio station presets.

Presets	1	2	3	4	5	6
AM						
FM 1						
FM 2						
SAT 1						
SAT 2/3						
Bass	Treble	Balance	Fade	Speed Sen. Vol.		

2. Disconnect both battery cables, negative cable first.

3. Remove the valve body.

Before lifting the vehicle;

- Place the transmission gear selector in Neutral.
- Refer to the appropriate ESM, section **Transaxle & Transmission**, for valve body removal.

NOTE: The number '7' is on the head of all bolts that need to be removed for valve body removal. Do not remove any bolt that does not have the number '7'.

CAUTION: Never allow any chemicals or fluids other than NS-3 CVT fluid or equivalent to enter the CVT assembly. Never allow any foreign debris, dust, dirt, etc. to enter the CVT assembly.

- For additional information, see video # 544: "CVT Belt Inspection". This video is located under the TECH TRAINING GARAGE VIDEOS tab in Virtual Academy.

Exploded View

SEC. 31

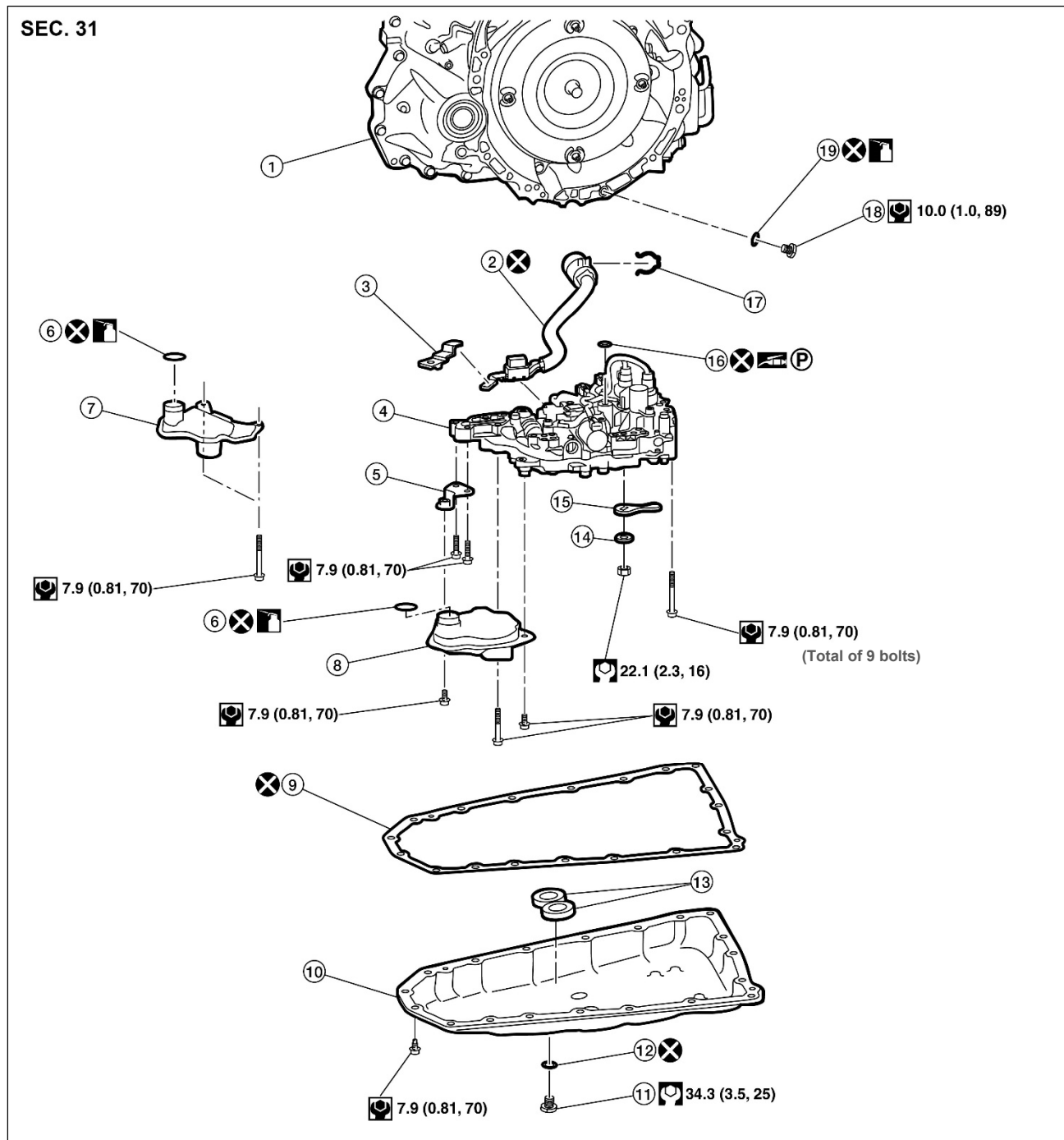

Figure 9

- | | | |
|------------------------------------|------------------------------------|---|
| 1. Transaxle assembly | 2. Terminal cord assembly | 3. CVT fluid temperature sensor bracket |
| 4. Control valve | 5. Bracket | 6. O-ring |
| 7. New-style oil strainer assembly | 8. Old-style oil strainer assembly | 9. Oil pan gasket |
| 10. Oil pan | 11. Drain plug | 12. Drain plug gasket |
| 13. Magnet | 14. Spring washer | 15. Manual plate |
| 16. Lip seal | 17. Snap ring | 18. Overflow plug |
| 19. O-ring | | |

: Always replace after every disassembly.

: N·m (kg-m, ft-lb)

: N·m (kg-m, in-lb)

4. Secure the front right tire with a suitable strap, so that it cannot rotate.

- This will assist in making the belt turn.

5. Mark the front left tire with a suitable marking.

- This will assure all 360° of the belt is inspected.



Figure 10

6. Using borescope J-51951 with mirror attachment, inspect the entirety of the two sides of the belt that come in contact with the pulleys (see page 12, Figure 15).

- Reference the Figures on pages 12 through 16 for comparison of an OK and NG belt condition.

NOTE:

- Be sure to remove the protective film from the mirror before the first use.
- Clean the camera lens and mirror before each inspection. Use 90% isopropyl alcohol and a lens swab from Lens Swab packet J-51963 listed in the **PARTS INFORMATION**.
- Before inspecting, make sure the camera handle's AA batteries are charged and the LCD monitor's battery is charged.

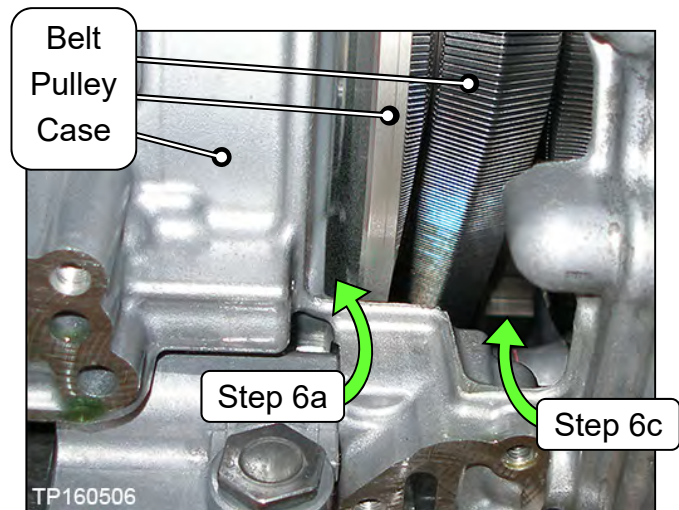

Figure 11

a. Insert the camera lens between the CVT case and pulley where shown in Figure 11 and Figure 12.

- Insert the lens approximately seven (7) inches, and then view the side of the belt that contacts the pulley.

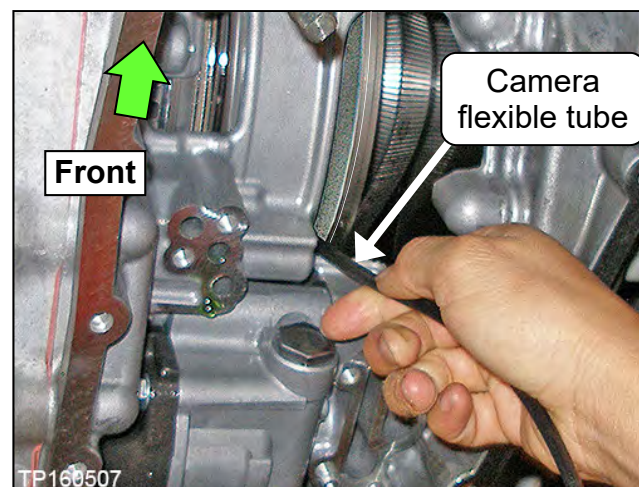

Figure 12

- b. Slowly and carefully turn the front left tire one full turn in the forward rotation to view all of the belt.

- Holding the borescope with one hand allows for turning the tire with the other hand (see Figure 13).

CAUTION: If the tire is rotated in the rearward rotation, the camera lens may get caught between the belt and pulley.



Figure 13

- c. If the inspection result is OK, inspect the other side of the belt.

- Insert the camera lens in the second location where shown in Figure 11 and Figure 14, and then perform step 6b again.

- d. If the inspection result is OK 360° on both sides of the belt, proceed to step 7 on the next page.

- For additional information, see video # 544: “CVT Belt Inspection”. This video is located under the TECH TRAINING GARAGE VIDEOS tab in Virtual Academy.

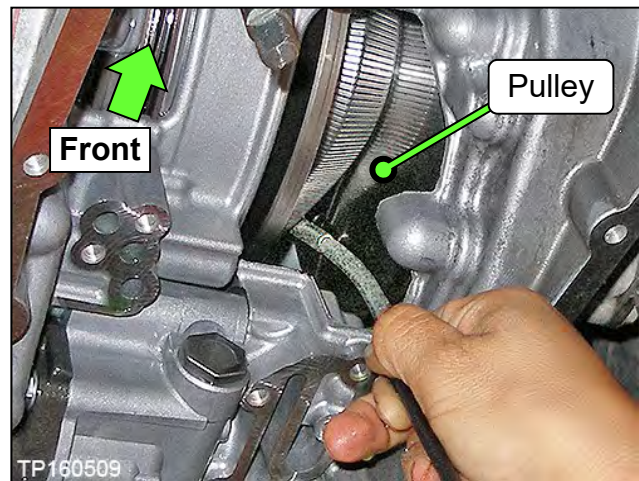

Figure 14

- e. If the inspection result is NG, proceed to step 8 on the next page.

7. If the belt inspection result is **OK**, replace only the valve body, and then reprogram the TCM if applicable.

- For valve body replacement, go to page 71, **Control Valve (Valve Body) Strainer and Pan Installation**.
- Check TCM part number (step 138 on page 79) and if needed perform reprogramming (step 138 on Page 79) if applicable.

IMPORTANT: Reprogramming, if needed, must be done before performing additional services.

8. If the belt inspection result is **NG**, replace the CVT sub-assembly and valve body, and then check step 138 on page 79 to confirm if a TCM reprogram is available.

- Go to **CVT Assembly Removal**, page 17.

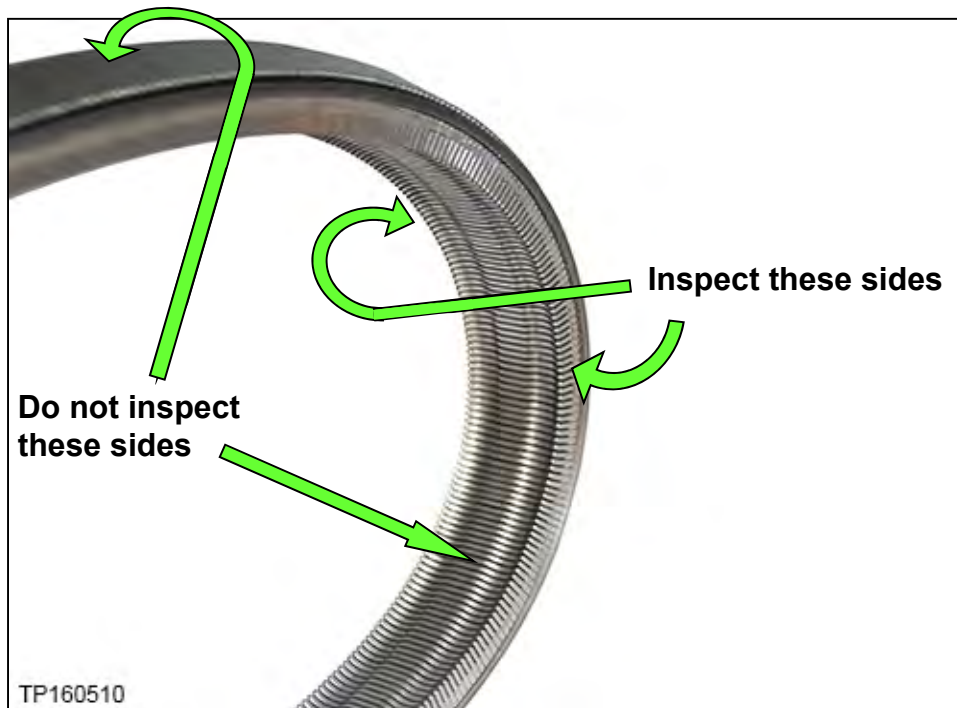
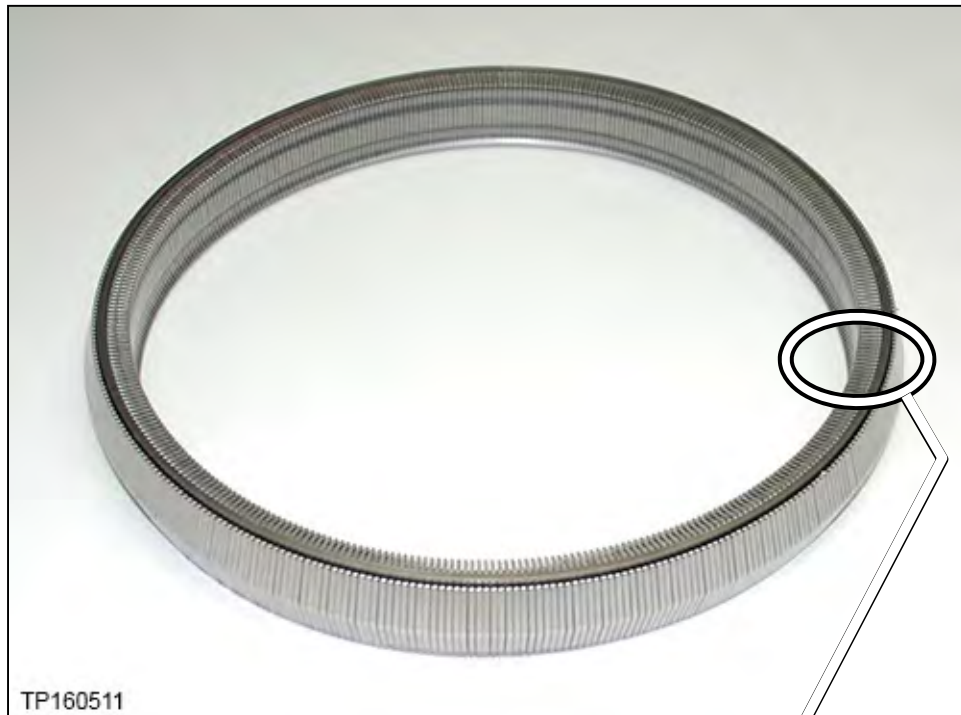
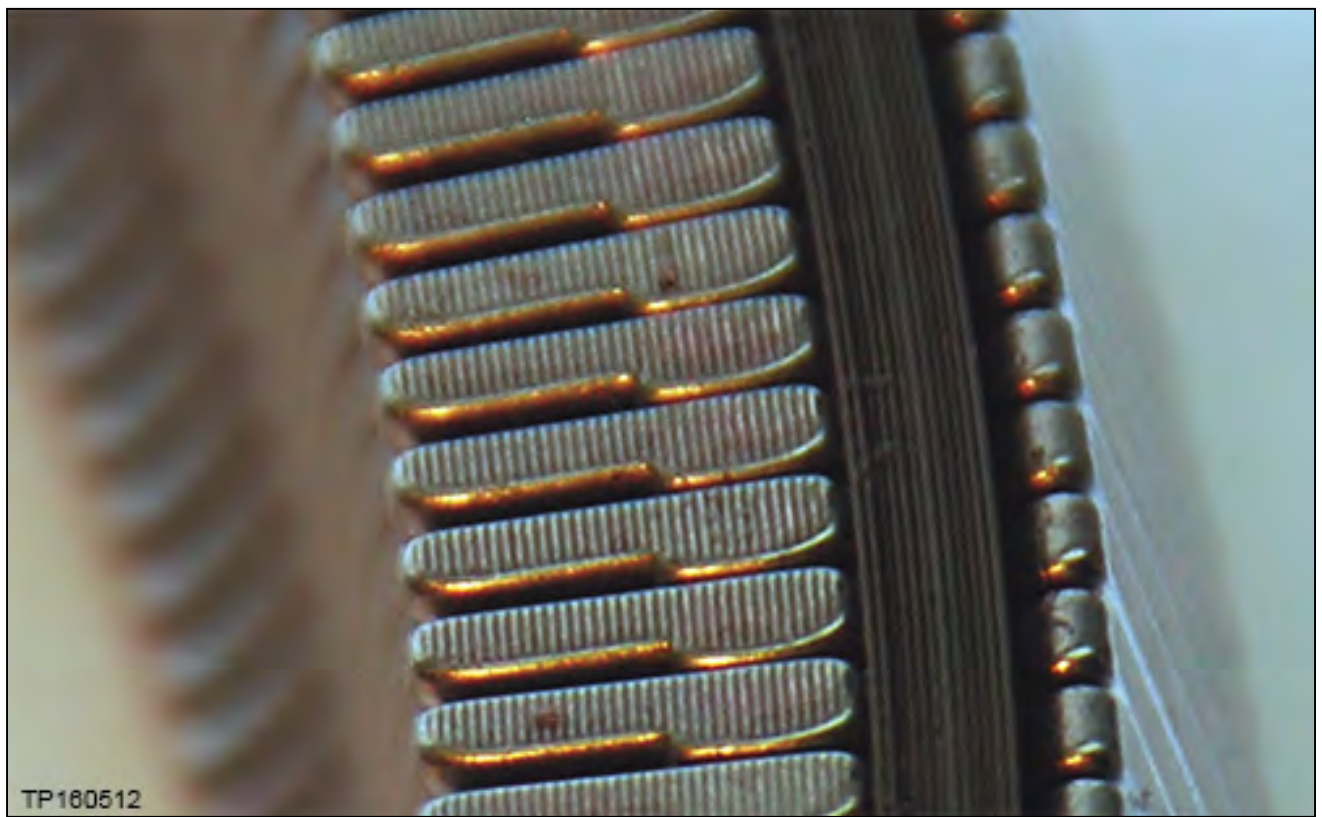

Figure 15



TP160511

Figure 16: New belt



TP160512

Figure 17: Close-up of section to be inspected

Pictures in Figure 18 and Figure 19 were taken with borescope J-51951.

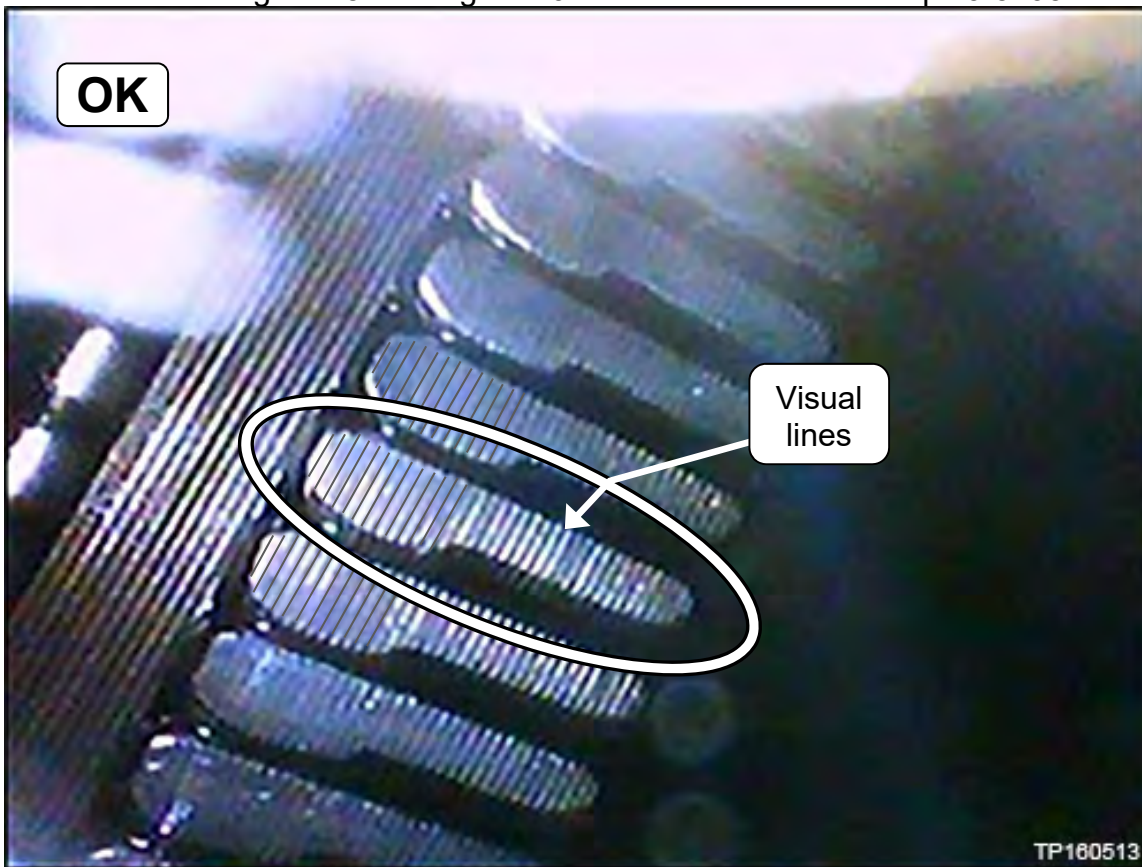

Figure 18: Belt is OK

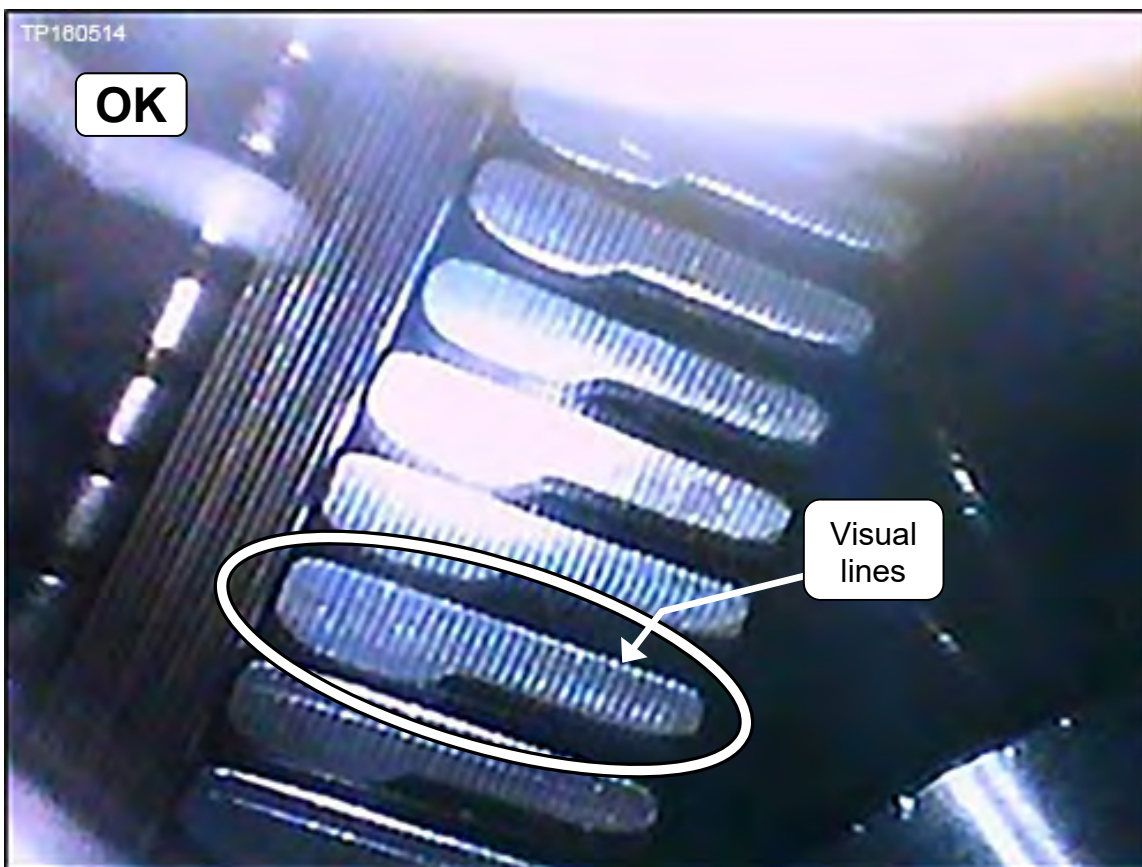

Figure 19: Belt is OK

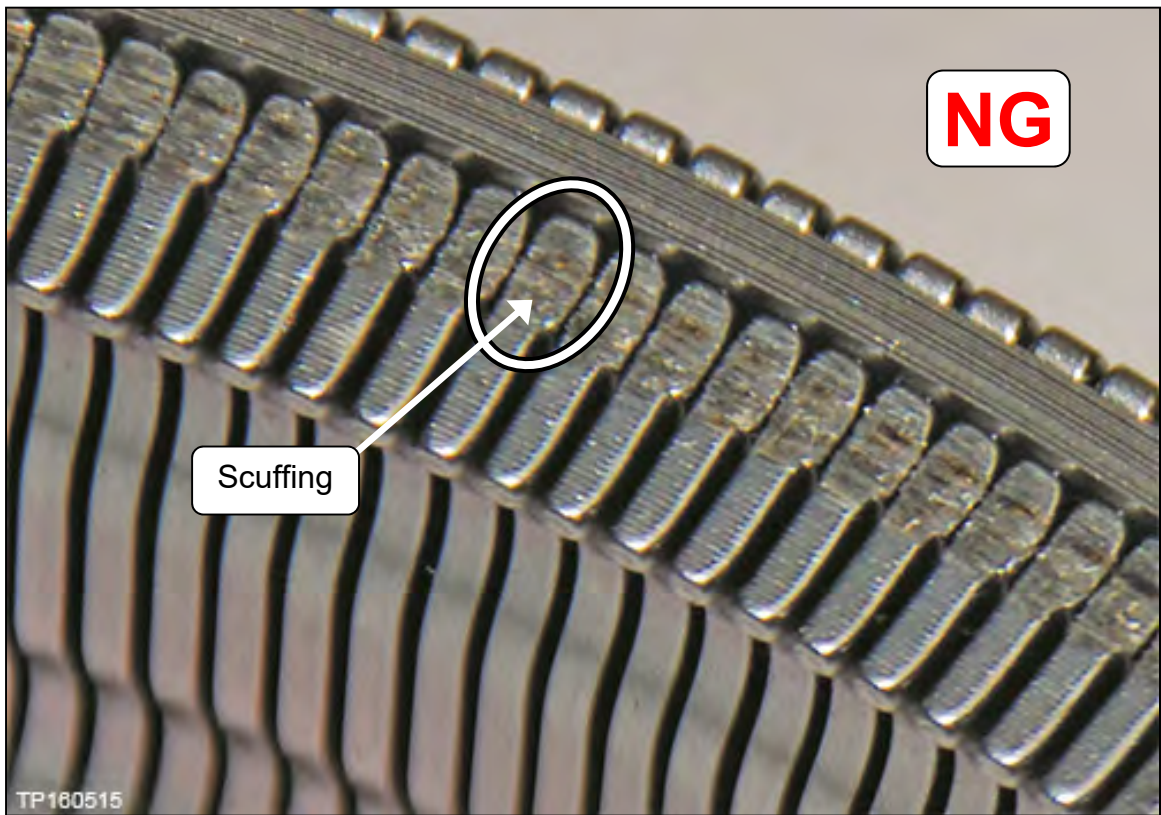

Figure 20: Example of NG belt

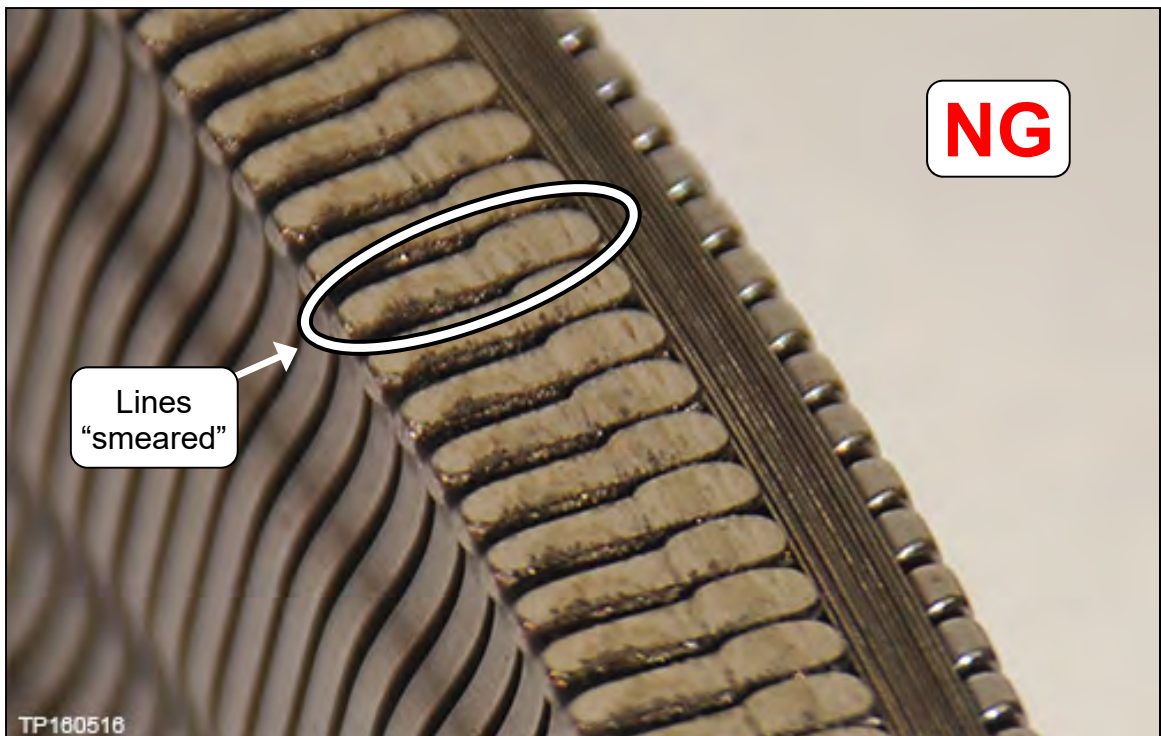

Figure 21: Example of NG belt

Pictures in Figure 22-Figure 24 were taken with borescope J-51951.



Figure 22: Example of NG belt



Figure 23: Example of NG belt



Figure 24: Example of NG belt

CVT Assembly Removal

Overview of Sub-assembly Repair

1. Apply rust penetrant as necessary to the dowel pins on the converter housing side and sub-assembly side cover
2. Remove CVT from the vehicle
3. Remove the Converter Housing, Oil Seals, Oil Pump Cover, Oil Pump and Oil Filter
4. Clean the CVT case surfaces
5. Clean the Oil Passages in the CVT Case, Oil Pump Cover, and CVT Filter Area
6. Check initial pulley movement characteristics
7. New Pump Installation
8. Replace the Side Cover – Pulleys and Belt
9. Confirm shift selector movement
10. Recheck new pulley movement characteristics matches that of the original assembly
11. Clutch Total Endplay Adjustment – Thrust Bearing Selection
12. Clean the Converter Housing Passages
13. CVT Reassembly
14. Control Valve (Valve Body) Strainer and Pan Installation
15. Install the CVT Assembly

NOTE: For additional information review video # 547: “CVT Belt and Pulley Replacement”.

- This video is located under the **TECH TRAINING GARAGE VIDEOS** tab in Virtual Academy.

9. Temporarily install the oil pan gasket and oil pan with four oil pan bolts to corners of the oil pan, hand tight (Figure 25).

NOTE: It is not necessary for the control valve to be installed, a new one will be installed later in the service procedure.

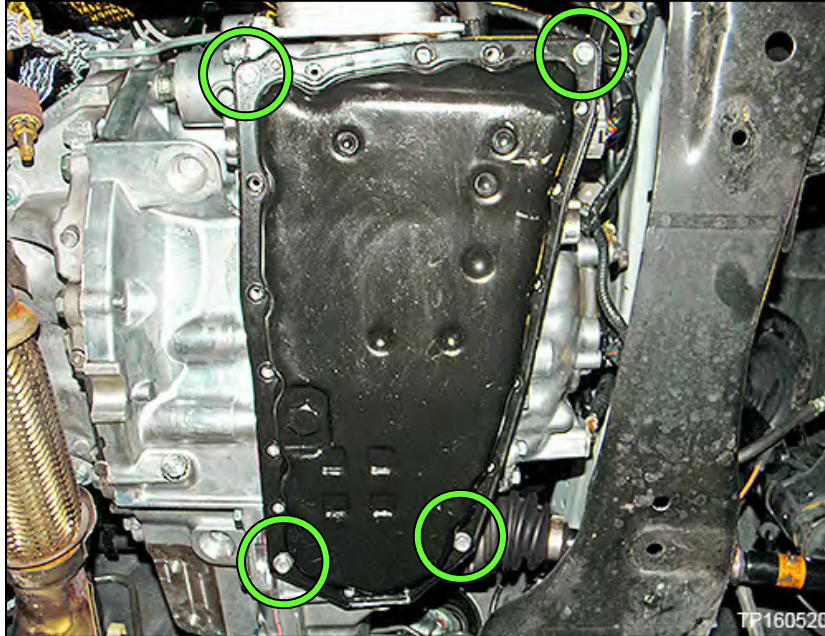

Figure 25

10. Remove the CVT from the vehicle.

- Refer to the Electronic Service Manual (ESM), section **Transaxle & Transmission** for removal information.

AWD Vehicles

CAUTION:

- Use extreme care when moving the axle in and out of the transfer case assembly.
- To avoid seal damage or deformation, properly support and guide the axle.

11. Place the CVT on a workbench with the oil pan side down.

- Use wood or plastic blocks to keep the CVT steady.

CAUTION: Do not deform the oil pan.

12. Remove the torque converter.



Figure 26

13. Drain CVT fluid out of the torque converter.



Figure 27

14. Remove the primary speed sensor.

IMPORTANT: The speed sensor will be re-used.

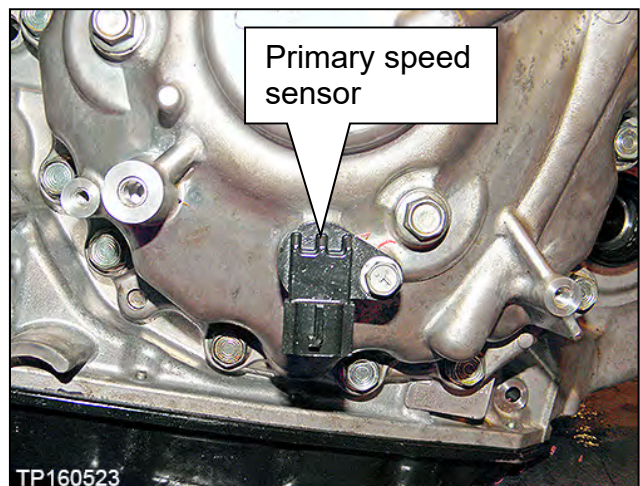

Figure 28

Remove the Converter Housing, Oil Seals, Oil Pump Cover, Oil Pump and Oil Filter

15. Remove all 23 converter housing mounting bolts (see Figure 29).

NOTE:

- These bolts will be replaced with new ones and will not be reused.
- Apply rust remover to the dowel pins if needed.

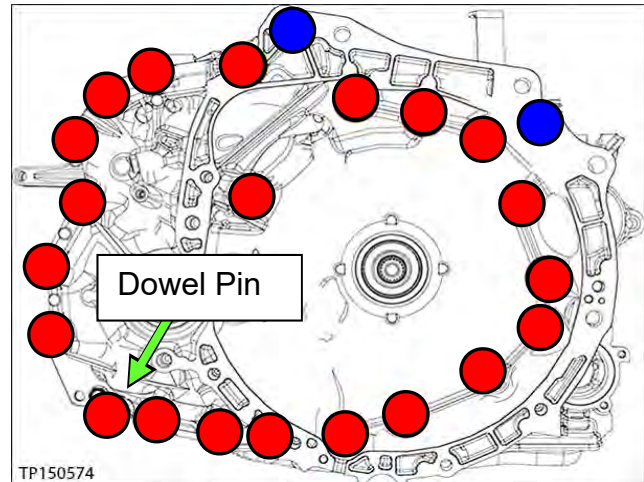

Figure 29

16. Separate and then remove the converter housing from the CVT case.

- Use Slide Hammer J-25721-A and Slide Hammer Bolt J-50255-UPD with J-Hook J-51923 at the cut out areas similar to the one shown in Figure 30 and Figure 31.

CAUTION: DO NOT use a pry-bar, chisel, etc. to separate the converter housing from the CVT case.

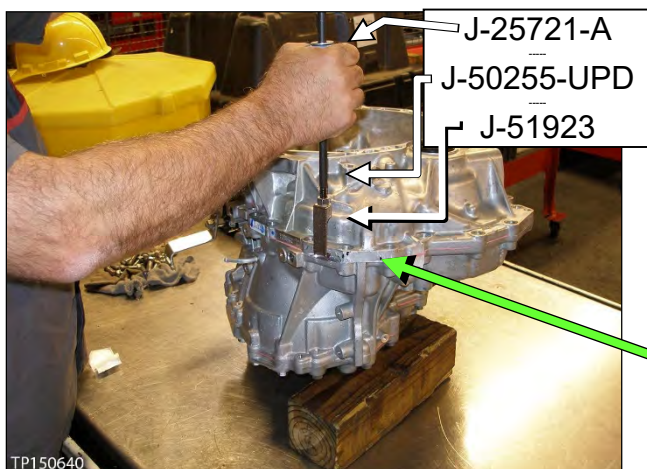

Figure 30

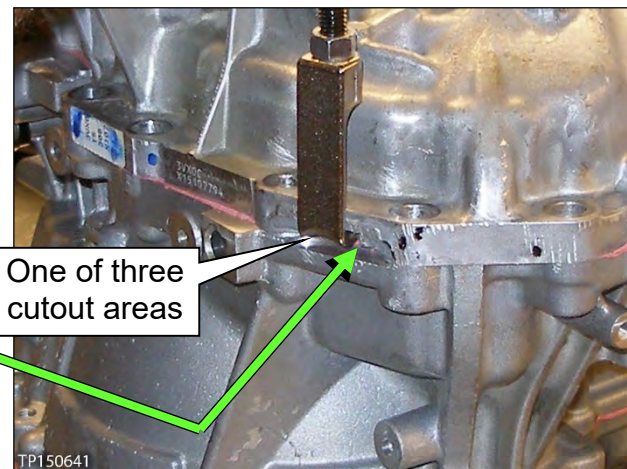

Figure 31

17. Note the location of the pin shown in Figure 32.

CAUTION: This pin can slip out during movement of the CVT while converter housing is removed.

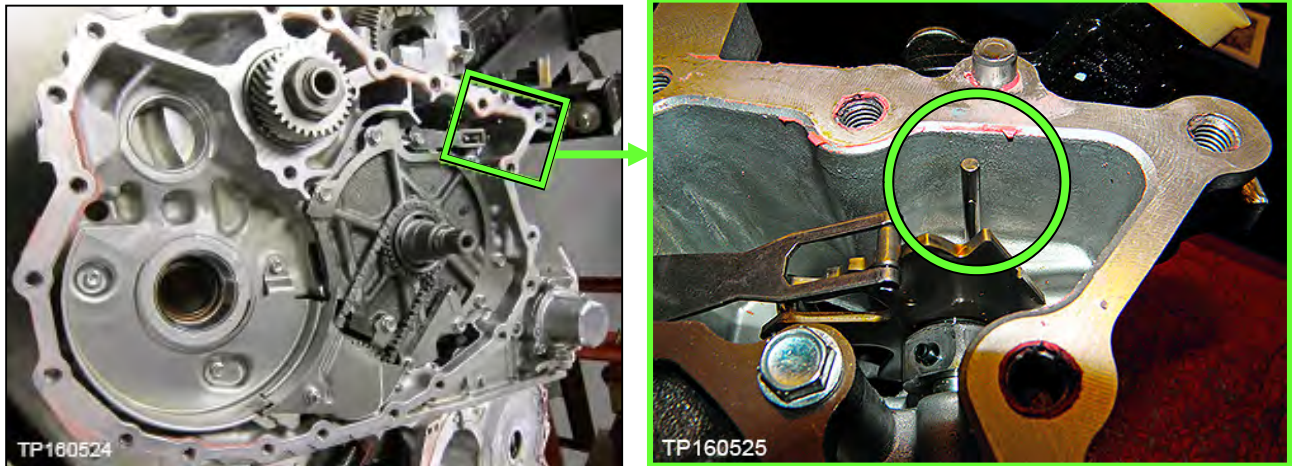

Figure 32

18. Remove the O-ring from the input shaft.

- This O-ring will be replaced with a new one.

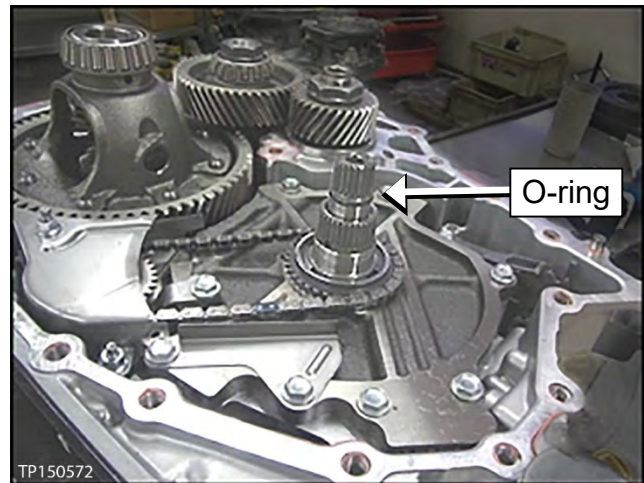

Figure 33

19. Carefully remove the reduction gear assembly (Figure 34).

20. Carefully remove the differential assembly (Figure 35).

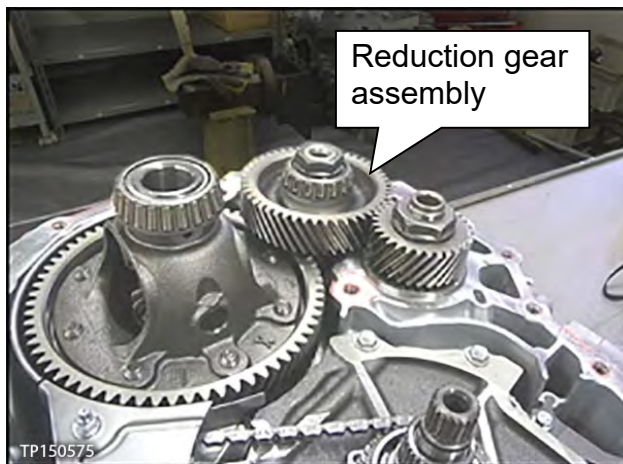

Figure 34

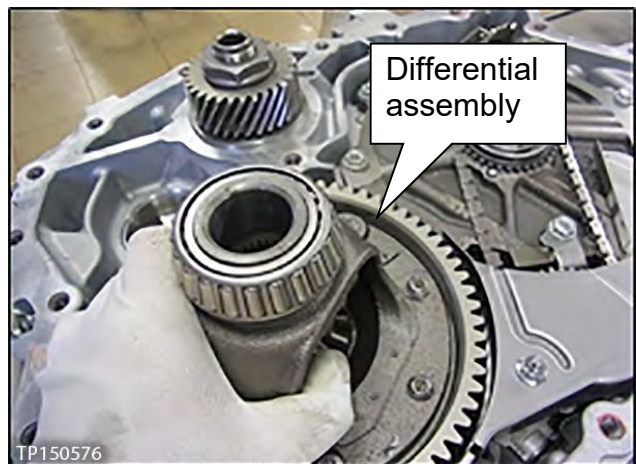

Figure 35

21. Remove the following oil seals using suitable tools:

CAUTION: Be careful not to damage any of the seal bore surfaces.

- a. CVT case differential side oil seal (drive shaft seal).
 - See Figure 36.

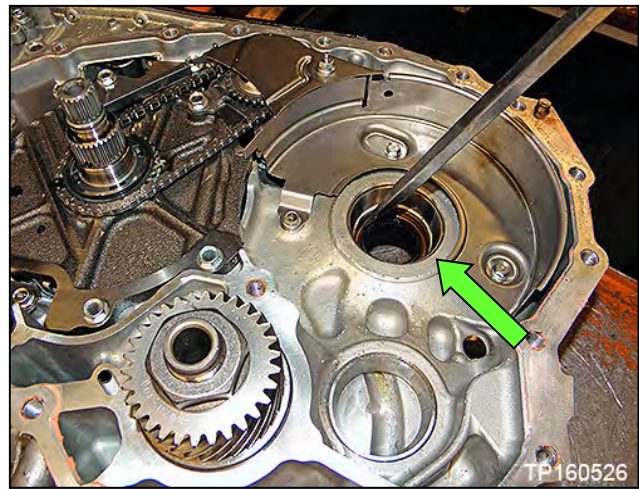

Figure 36

- b. Torque converter seal (Figure 37).

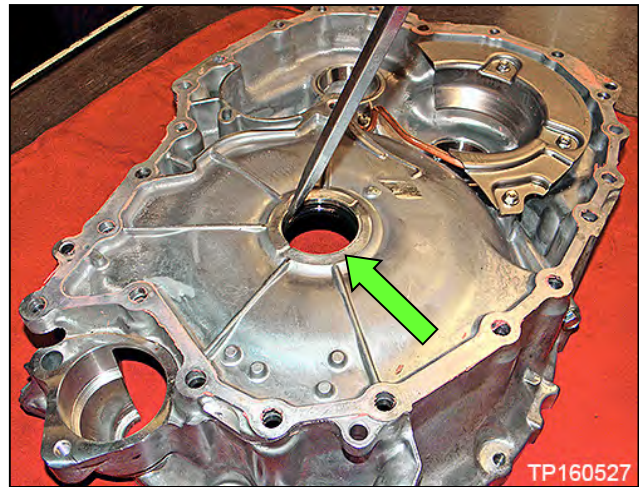

Figure 37

- c. Converter housing differential side oil seal (drive shaft seal).

- See Figure 38.

NOTE: All wheel drive transfer case O-ring will be replaced later in this procedure.

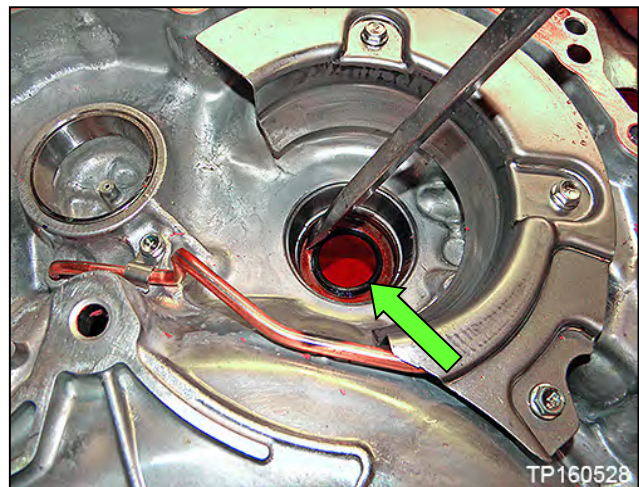

Figure 38

22. Remove the two (2) nuts from baffle plate A, and then remove baffle plate A (see Figure 39).

CAUTION: To avoid rounding off these nuts, it is best to use a 3/8 inch drive 6-pt 10 mm socket.

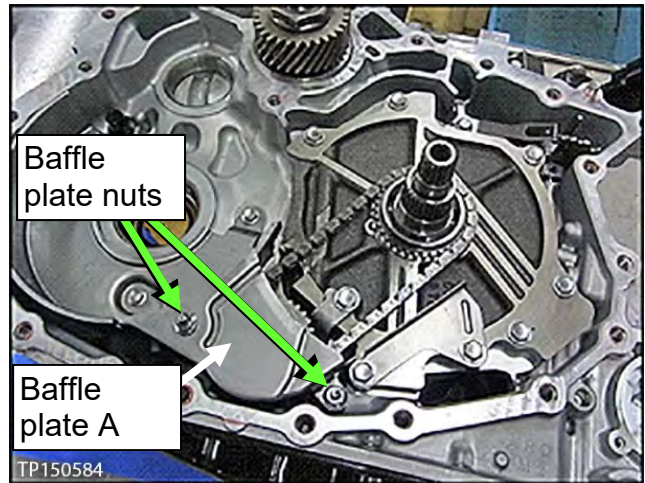

Figure 39

23. Remove the oil pump chain, driven and drive sprockets as one assembly (Figure 40).

- Spread the snap ring to remove sprocket (Figure 41).

IMPORTANT: The drive sprocket has a specific top and bottom. Keep the sprockets and chain together after removed.

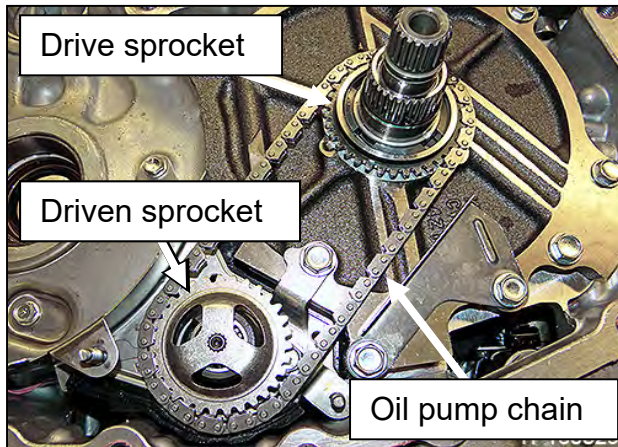

Figure 40

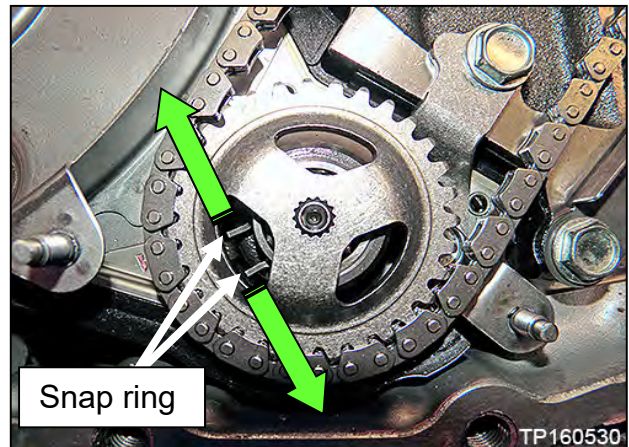

Figure 41

24. Remove the “Pump cover” (dummy cover) thrust washer (Figure 42).

- This thrust washer will be reused.

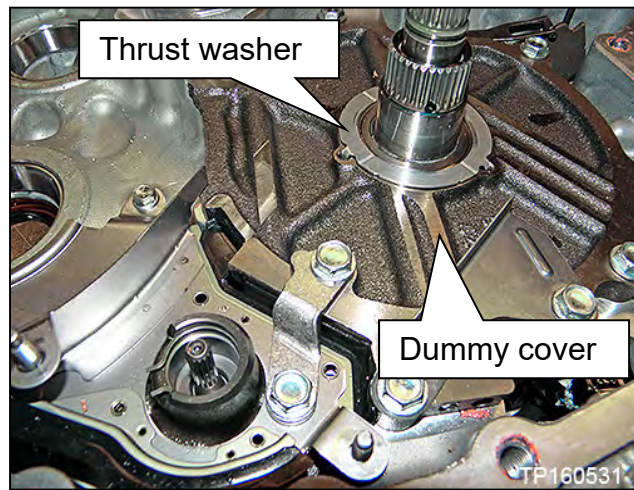

Figure 42

25. Remove the Oil pump snap ring (Figure 43).

- Lightly push the ends of the snap ring together, rotate one side upwards while pulling the snap ring towards the pump opening.

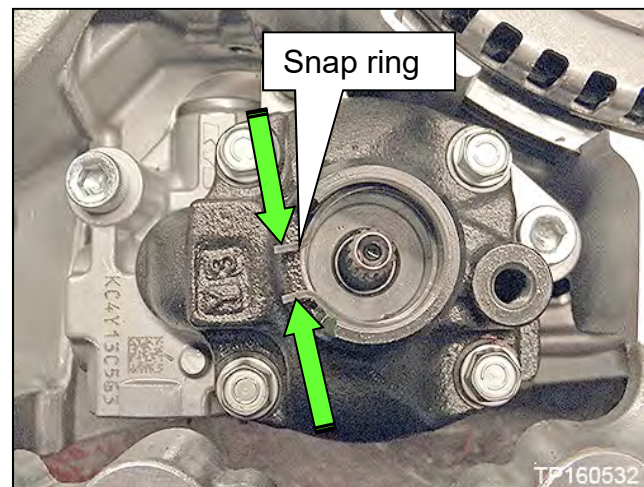

Figure 43

26. Remove the Oil pump bracket (Figure 44).

- Retained by two bolts.

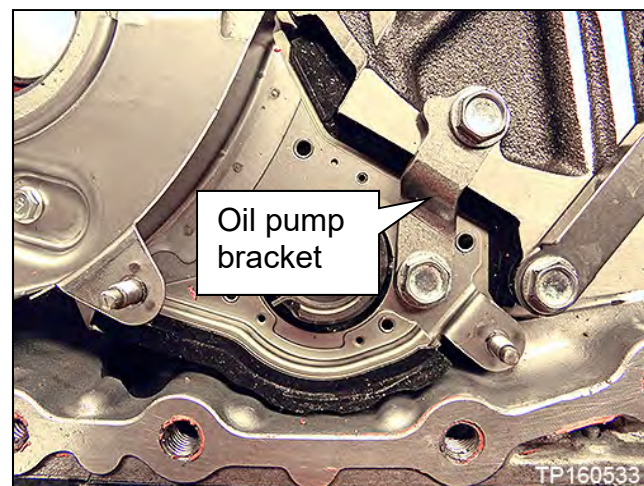

Figure 44

27. Remove the three bolts from baffle plate B, and then remove baffle plate B (Figure 45).

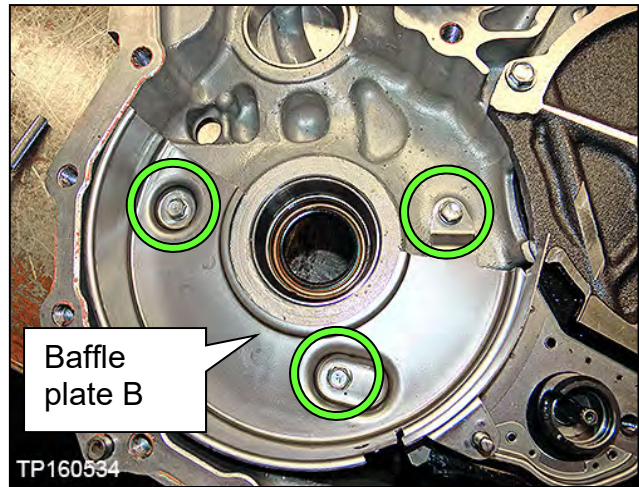

Figure 45

28. Remove the two bolts from baffle plate C, and then remove baffle plate C (Figure 46).

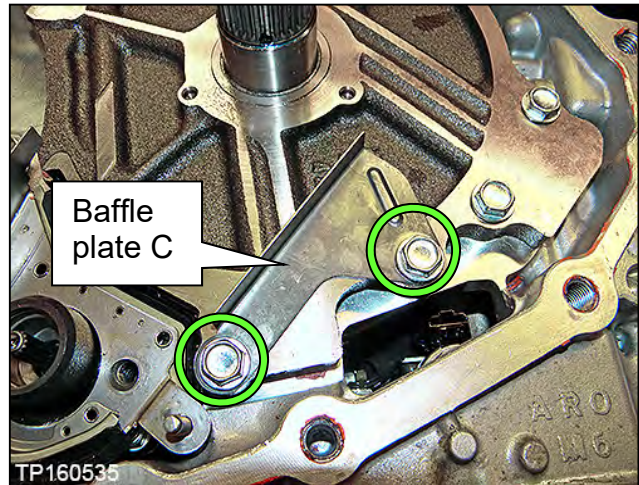

Figure 46

29. Remove the five dummy cover bolts, and then remove the dummy cover. See Figure 47.

NOTE: These bolts will be reused.

IMPORTANT:

- Lift the dummy cover from sides **ONLY**. Do **NOT** lift from the input shaft (Figure 47). This can lift the clutch pack out.
- Do **NOT** remove the lathe cut seals (white seals in Figure 48) from the dummy cover. These seals will be reused.
- **Lathe cut seals must be in their correct positions during final assembly to prevent drivability issues.**

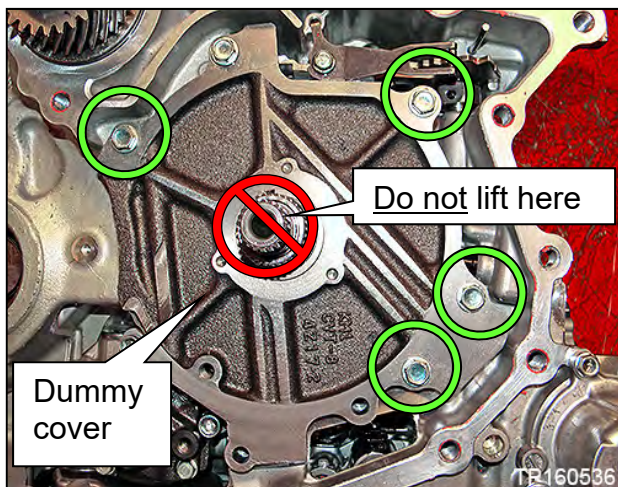

Figure 47

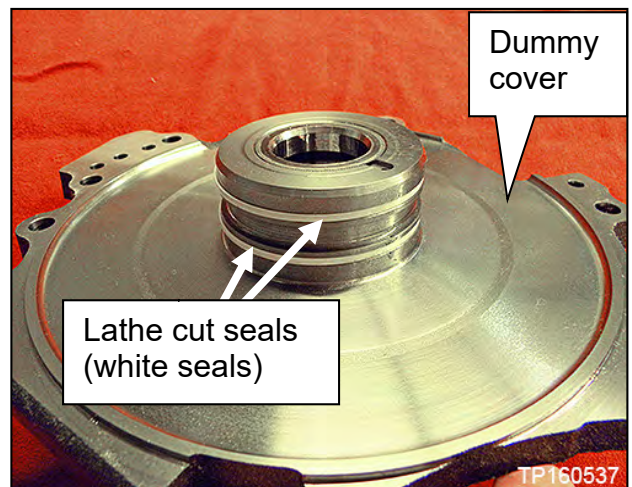

Figure 48

30. Remove the thrust bearing from the clutch assembly bore (Figure 49).

NOTE: Take care removing the thrust bearing so that the lathe cut seals are not knocked out of their grooves.

IMPORTANT:

- The thrust bearing has two different sides. As the thrust bearing is removed, note the thrust bearing orientation so that the new bearing can be installed in the same orientation.
- This bearing will not be re-used.

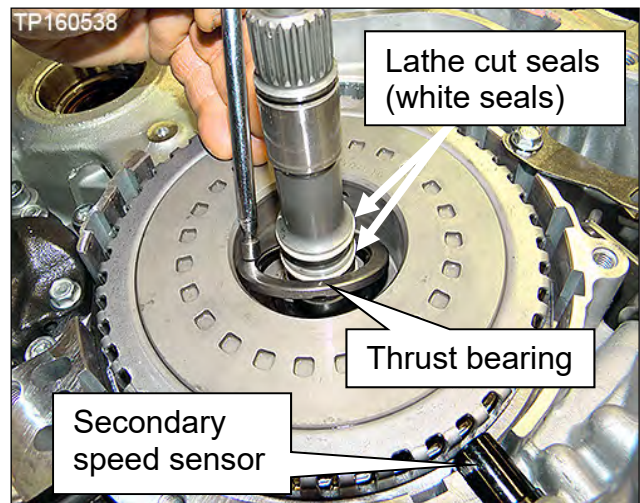

Figure 49

31. Wipe any metallic debris from the face of the secondary speed sensor (Figure 49).

32. Remove the oil pump as follows:

- a. Remove the fitting bolt located above the left rear corner of the oil pan gasket surface (Figure 50).

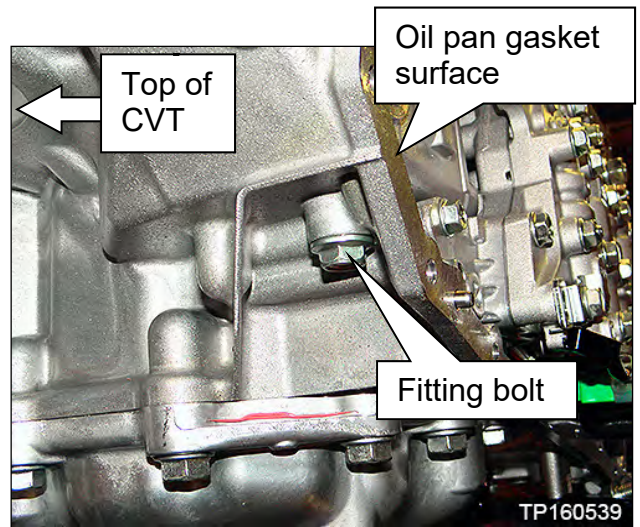

Figure 50

- b. Remove the three oil pump Allen-head bolts, and remove the oil pump (Figure 51).

NOTE:

- Do NOT discard the Allen-head bolts. Bolts will be re-used.
- New oil pump will be installed at later steps.

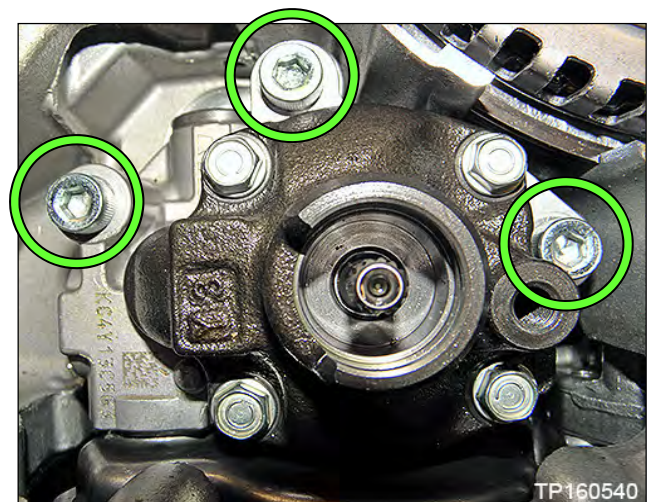

Figure 51

33. Remove CVT fluid filter as follows:

- a. Remove the 4 bolts and then remove the CVT fluid filter cover (Figure 52).

NOTE: Bolts will be reused.

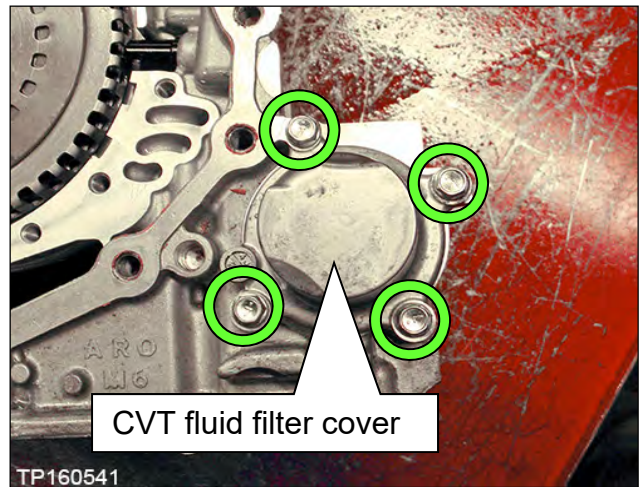

Figure 52

- b. Remove the CVT fluid filter with grommet seal and O-ring seal (Figure 53).

- Discard the oil filter and seal. They will be replaced.
- Grommet is fitted to the bottom end of the filter and is included with replacement filter (Figure 54).

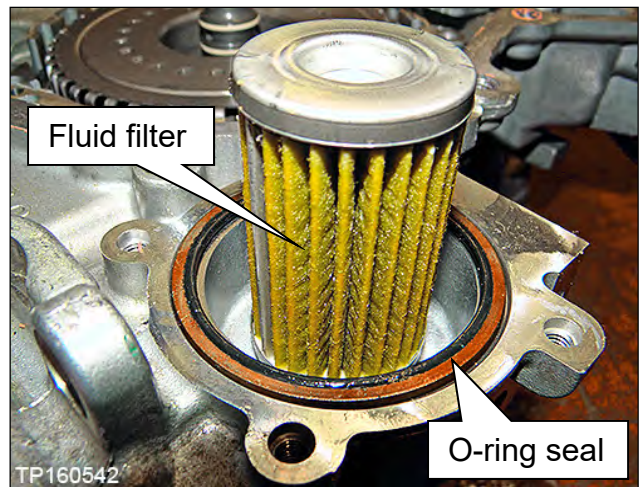

Figure 53



Figure 54

Clean the CVT case surfaces

34. Thoroughly clean the mating surfaces of the CVT case and Torque Converter Housing.

- A plastic scraper can be used.

CAUTION:

- DO NOT use sanding discs, similar abrasive tools, or metal blades.
- Use brake spray or equivalent solvent and lint-free towels only.
- Make sure brake spray or solvents used are compatible with local regulations.
- Prevent debris from entering in the CVT.
- Make sure rust and debris have been cleaned off of dowel pins and receiving holes (Figure 55).

35. Clean the dowel pins and dowel pin receiving holes of any rust or debris (Figure 55).

NOTE: Use small wire brush or similar tool at the inside surface of dowel pin holes. **DO NOT SCRAPE CVT CASE** mating surfaces.

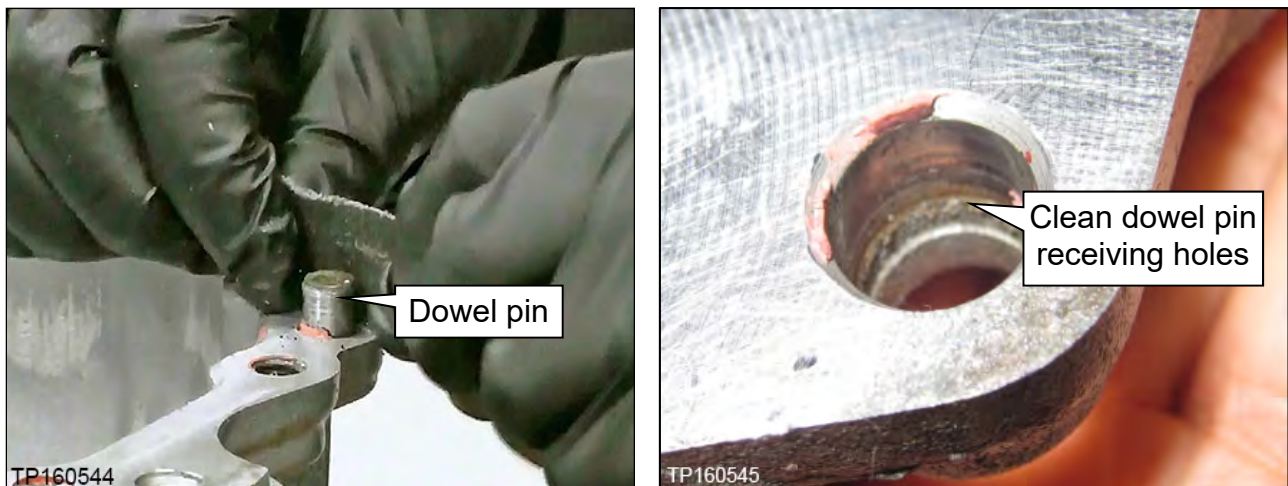

Figure 55

Clean the Oil Passages in the CVT Case, Oil Pump Cover, and CVT Filter Area

In the following steps:

- Brake spray or a suitable cleaning solvent and compressed air will be used to clean out oil passages in the CVT assembly.
 - Make sure the brake spray or solvents are compatible with local regulations.

WARNING: Wear eye / face protection when using compressed air and cleaning fluids.

CAUTION: Regulate air pressure up to a maximum of 75 PSI.

36. Clean the area where the CVT fluid filter fits (Figure 56).

- Make sure the old filter grommet seal is removed.

37. Clean the fluid passages to and from the filter (Figure 56).

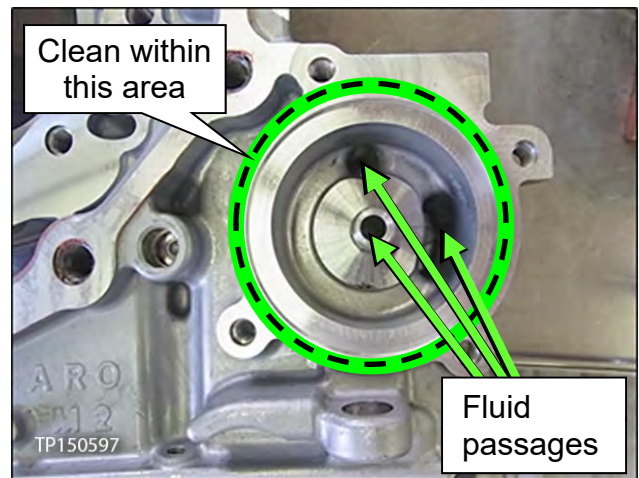

Figure 56

38. Spray brake clean in all oil passages of the CVT case where shown in Figure 57 and Figure 58.

- Do not spray brake clean into the clutch pack.

39. Apply compressed air in the same passages.

NOTE: Do not stand in front of the passages while using compressed air.

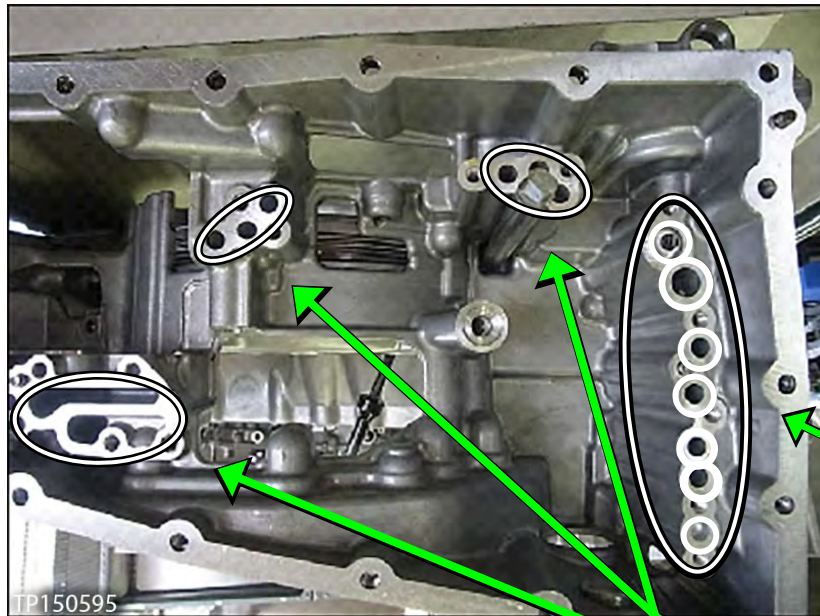

Figure 57

Apply cleaner, and then 75 PSI maximum air pressure in these passages.

Air pressure comes out these passages.

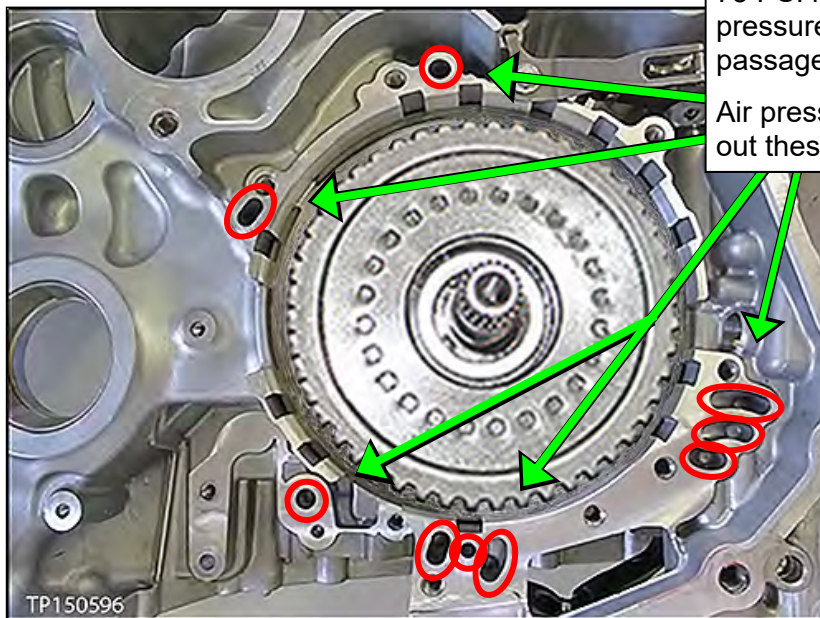

Figure 58

40. Temporarily install fluid filter cover.

New Oil Pump Installation

IMPORTANT: For the following service procedures a **PARTS KITS REFERENCE TABLE** is provided on page 95.

- Use the check off column on the left to ensure the correct new part is installed at each step, and then attach to the repair order.

41. Install the new oil pump using three original Allen-head bolts (Figure 59).

NOTE:

- Finger tighten the Allen-head bolts at this time.
- Oil Pump kit includes new pump, O-ring and snap ring.

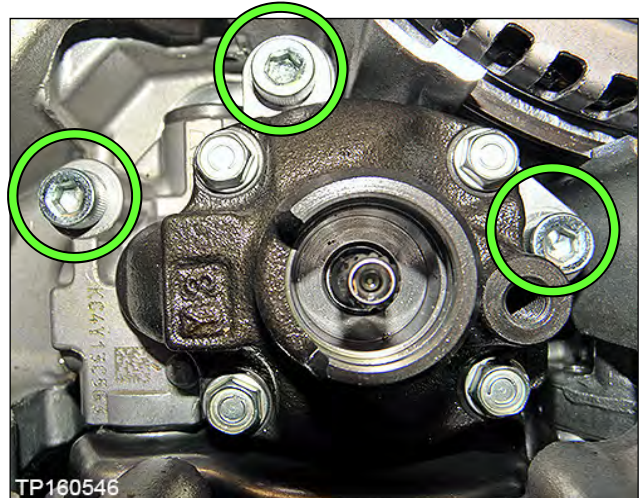

Figure 59

42. Place new O-ring on the fitting bolt, and coat with CVT fluid (Figure 60).

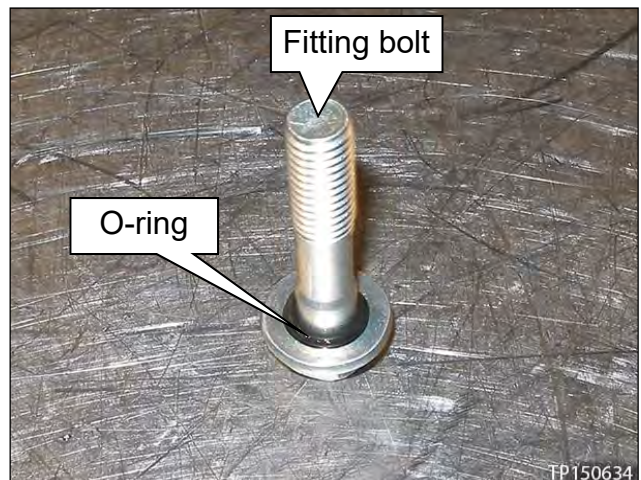

Figure 60

43. Install the fitting bolt finger tight (Figure 61).

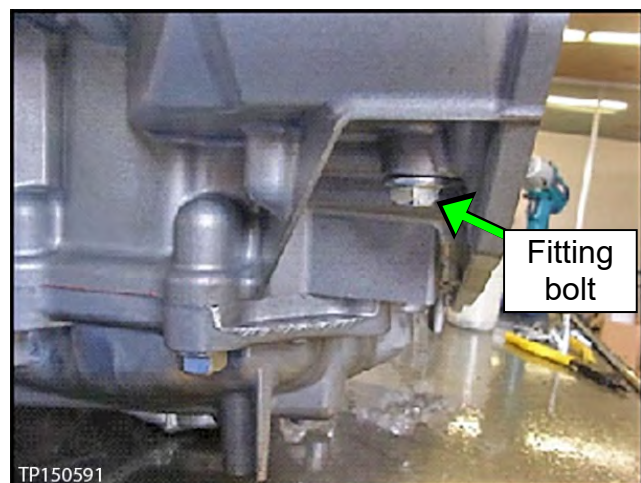

Figure 61

44. Torque the three Allen head bolts and fitting bolt.

- Allen head bolt torque: 17.6 – 20.6 N•m (1.79 – 2.1 kg-m, **13.0 – 15.2 ft-lb**)
- Fitting bolt torque: 26.0 – 30.0 N•m (2.65 – 3.06 kg-m, **19.2 – 22.1 ft-lb**)

45. Install the new snap ring (Figure 62).

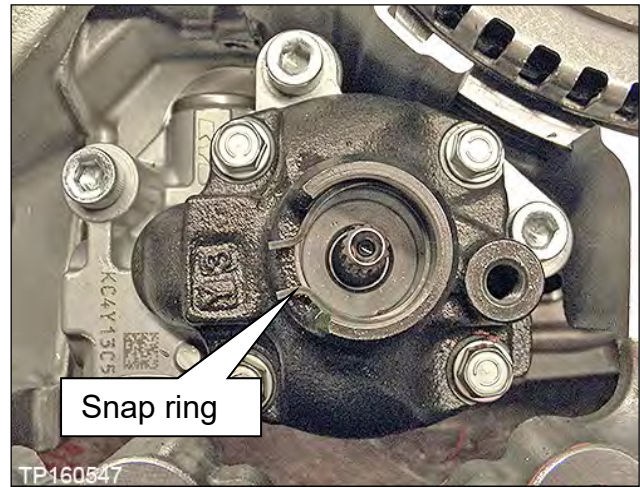

Figure 62

Replace the Side Cover – Pulleys and Belt (sub-assembly)

Review video # 547: “CVT Belt and Pulley Replacement” and fast forward to minute marker 3:14. This video is located under the **TECH TRAINING GARAGE VIDEOS** tab in Virtual Academy.

46. Temporarily install the dummy cover with 3 bolts, finger tight (Figure 63).

IMPORTANT:

- Do not install the thrust bearing to the clutch assembly bore at this time.
- If cover does not seat flush see trouble shooting **The Dummy Cover Will Not Sit Flush** on page 90.

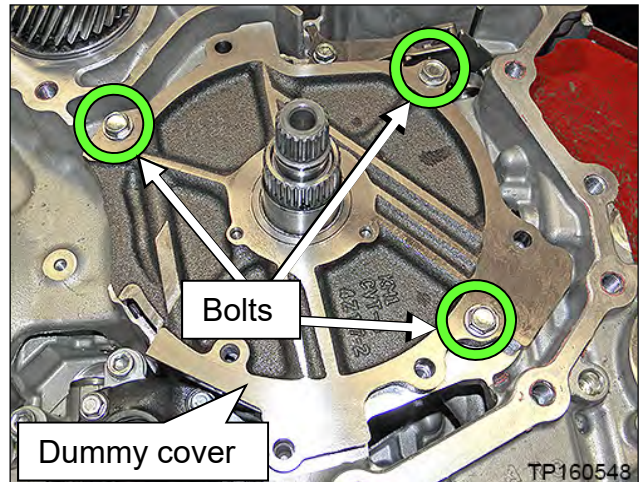

Figure 63

47. Temporarily install the converter housing onto the CVT case with three bolts finger tight (Figure 64).

IMPORTANT: When fitting the CVT case surfaces, DO NOT use the bolts to draw in the case halves. Make sure the case surfaces are flush, and have no gaps prior to installing the bolts.

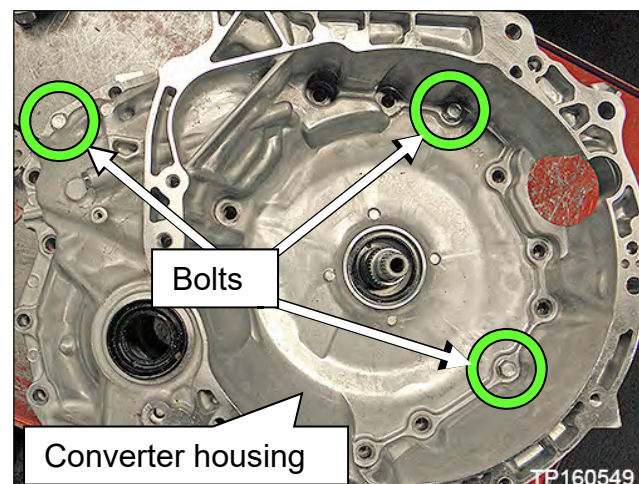

Figure 64

48. Flip the CVT case so that the converter housing faces down and side-cover faces up.

- Lifting fixtures J-51595 and J-51595-1 can be used for this step.
- See Figure 66 for lifting fixture information.

CAUTION:

- Do not hit the manual shaft (Figure 65) while flipping the CVT; the manual shaft is longer than the oil pan mating surface. Use a plastic / wooden block to support as needed.
- Note the location of the terminal connector harness. Do not pinch the terminal connector harness between the CVT case and work bench or supporting blocks.

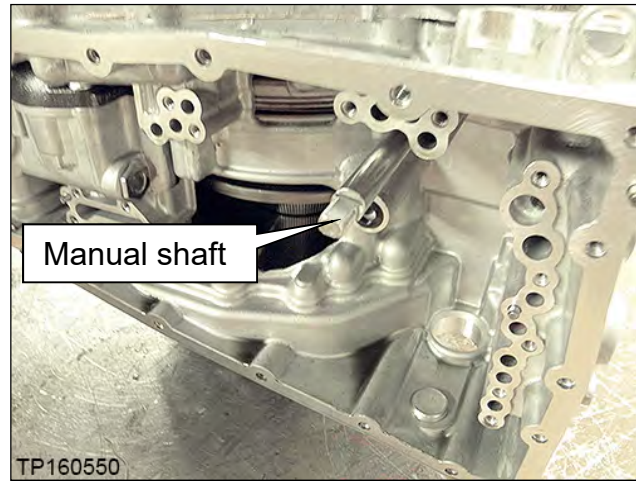

Figure 65

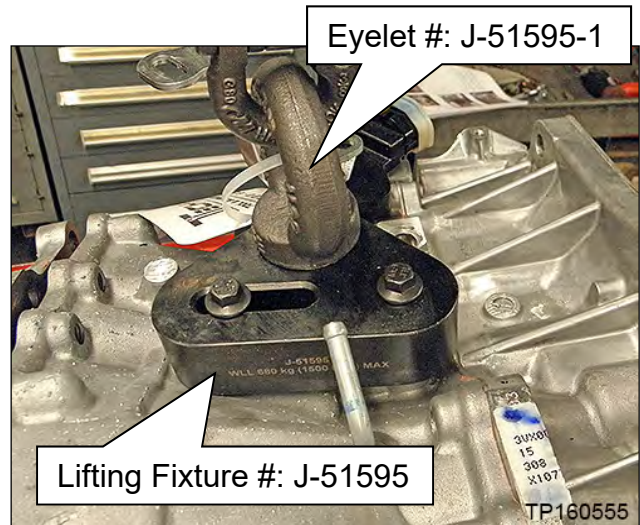

Figure 66

49. Rotate the primary pulley by hand to check the pulley's rotational characteristics.

IMPORTANT: Remember the pulley's rotational characteristics. This will be used as a reference after the new side cover-pulleys and belt sub-assembly (sub-assembly) have been installed.

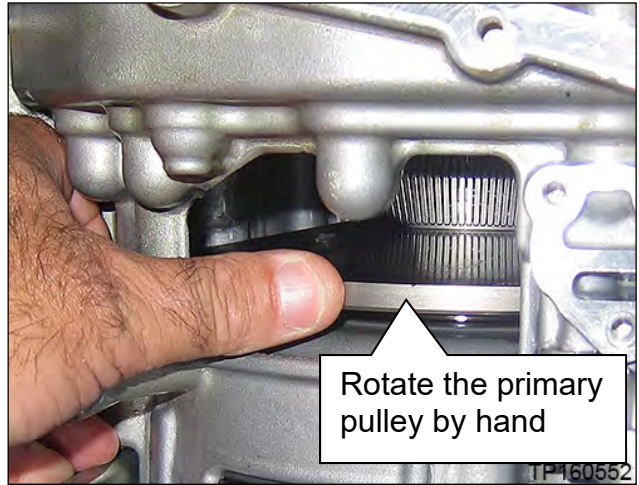

Figure 67

WARNING: Do not place fingers between the pulley and the CVT case.

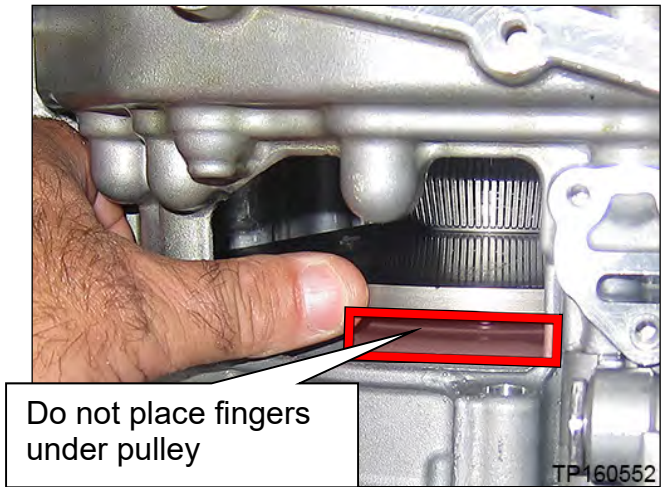

Figure 68

50. Remove the nineteen (19) side cover fixing bolts (Figure 69).

- These bolts will be replaced with new ones and will not be reused.

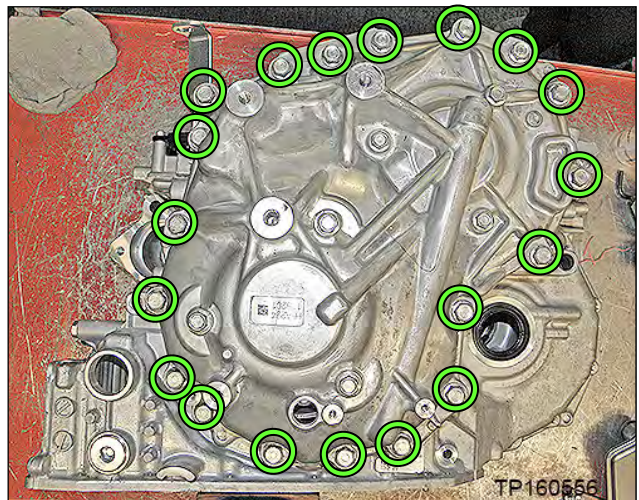

Figure 69

NOTE: When working with sub-assembly install, uninstall, and bracket attachment, it is critical that CVT and sub-assembly are level. If not level, the pulleys and bearings can sit slightly at an angle and will hinder installation.

CAUTION: Always handle the CVT and component assemblies carefully and with the appropriate lifting tools.

51. Attach appropriate lifting fixture to the side cover (Figure 70).

- For Altima, proceed to step 52 on page 37 for lifting fixture procedure.
- For Rogue, proceed to step 55 on page 39 for lifting fixture procedure.

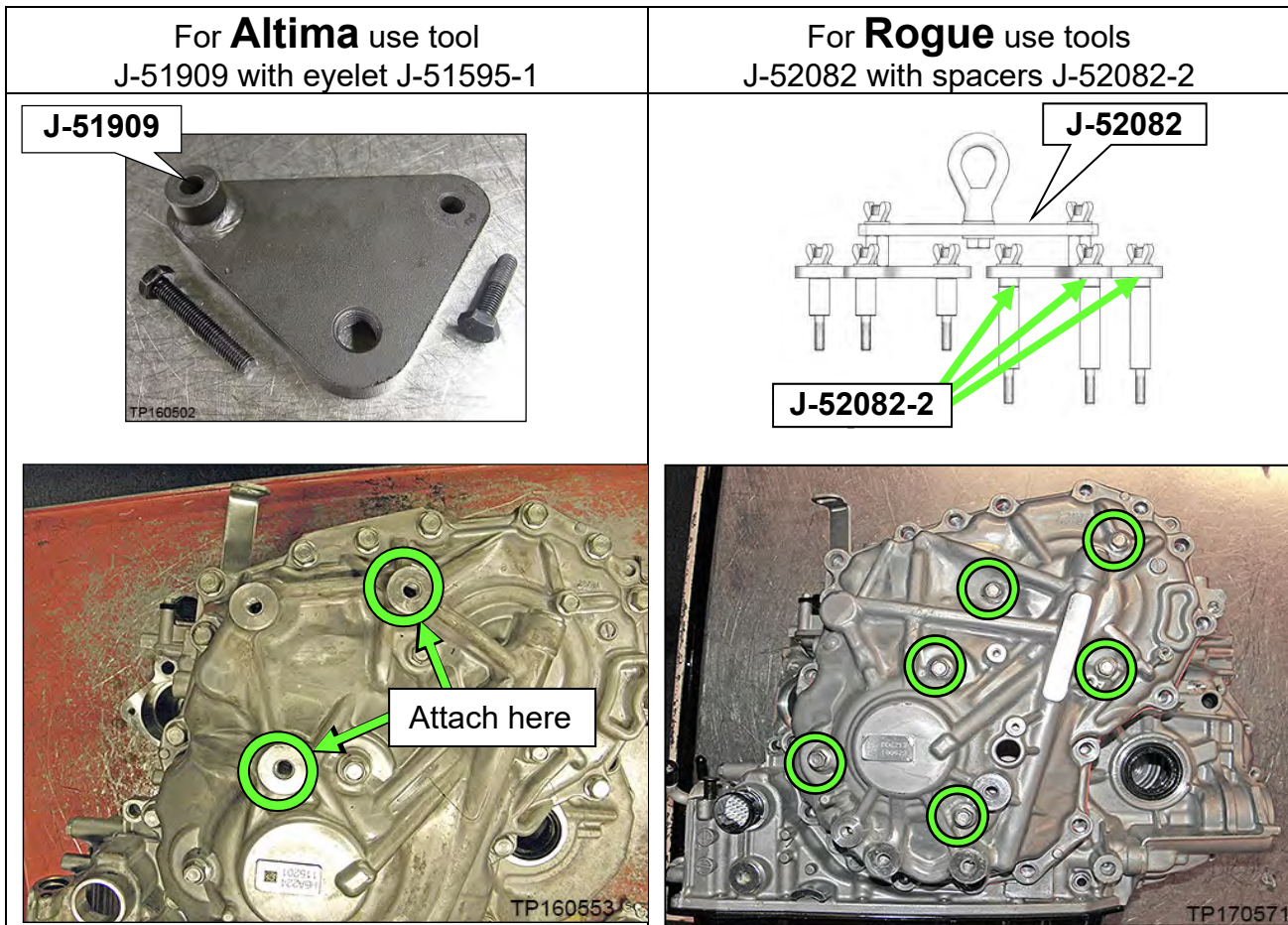

Figure 70

Altima Lifting Fixture procedure

52. Attach Lifting Fixture J-51909 (Figure 71) with eyelet from J-51595 (Figure 66) to the side cover at point shown in Figure 72.

- Lifting Fixture bolt torque (Max.):
45 N•m (4.6 kg-m, **33 ft-lb**)

CAUTION: Do not cross thread bolts when attaching to side cover.

- Eyelet bolt torque: Hand tight.

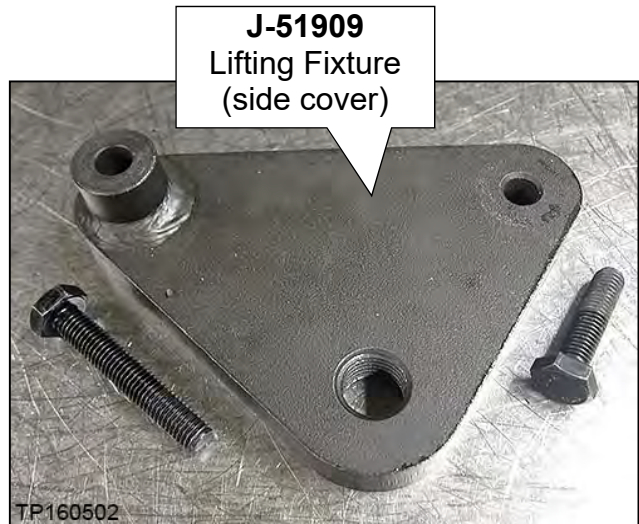

Figure 71

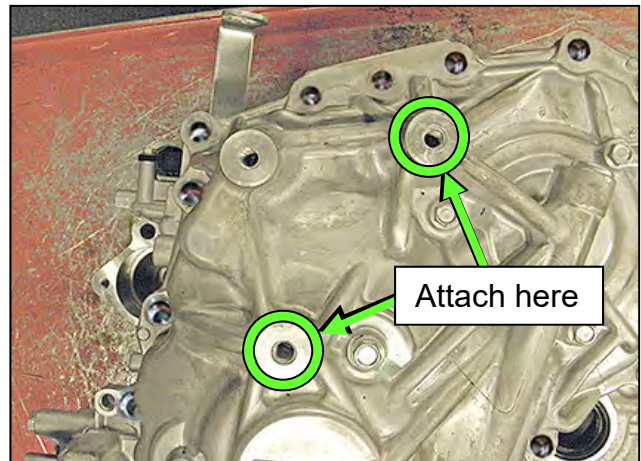

Figure 72

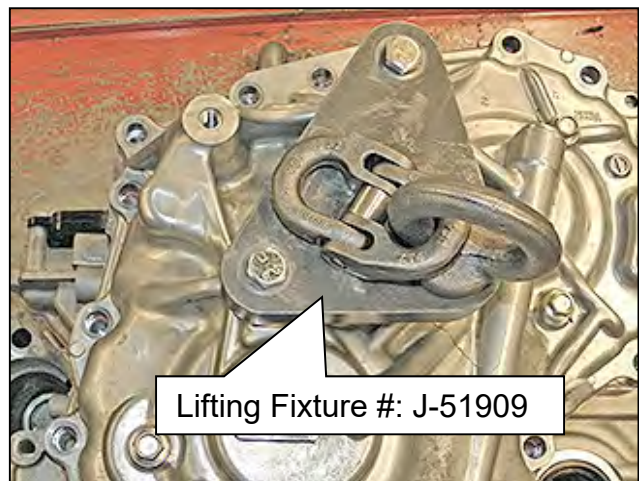

Figure 73

Altima Lifting Fixture procedure (continued)

53. Install the two alignment Guide Pins (J-51959 - Guide Pins) as shown in Figure 74 and Figure 75.

NOTE:

- The Guide Pins should be located on opposite sides of the sub-assembly.
- Guide Pins should be placed as far apart as possible.
- Guide Pins must be placed next to dowel pins (Figure 75).

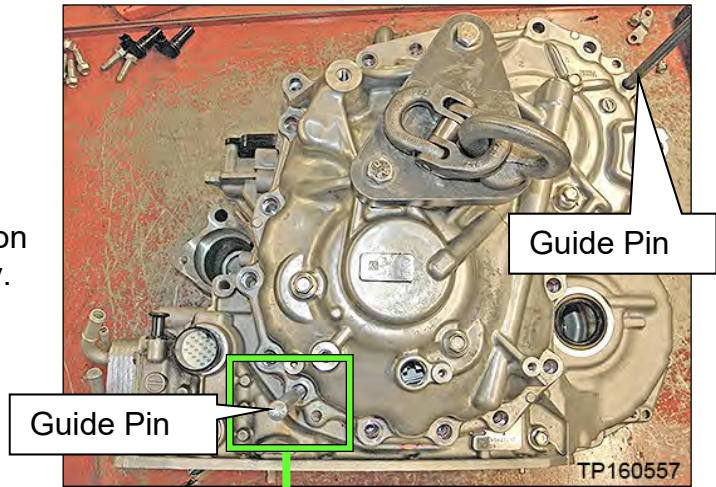

Figure 74

54. Proceed to step 58 on page 41.

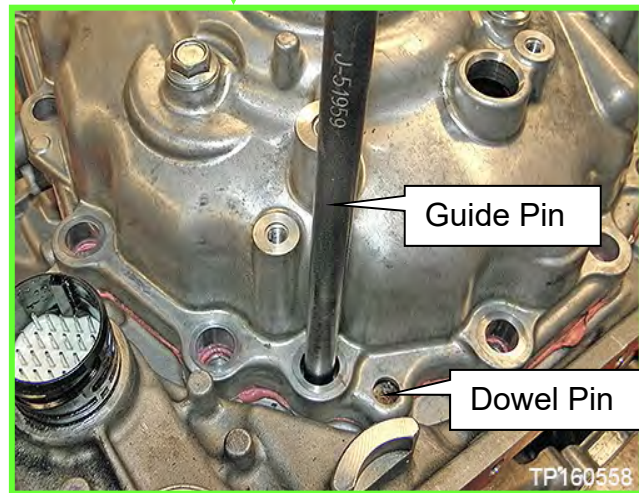

Figure 75

Rogue Lifting Fixture procedure

55. Remove the six (6) pulley bracket bolts.

- Bolts will be reinstalled to the original pulley and belt sub-assembly.

56. Attach universal Lifting Fixture J-52082 with spacers J-52082-2 to the side cover as shown in Figure 77.

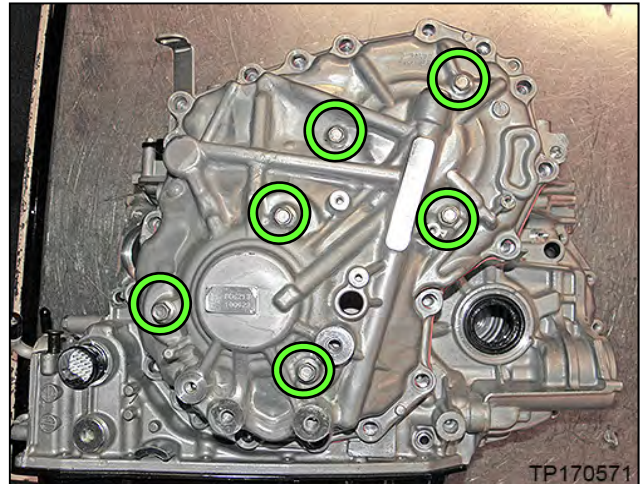
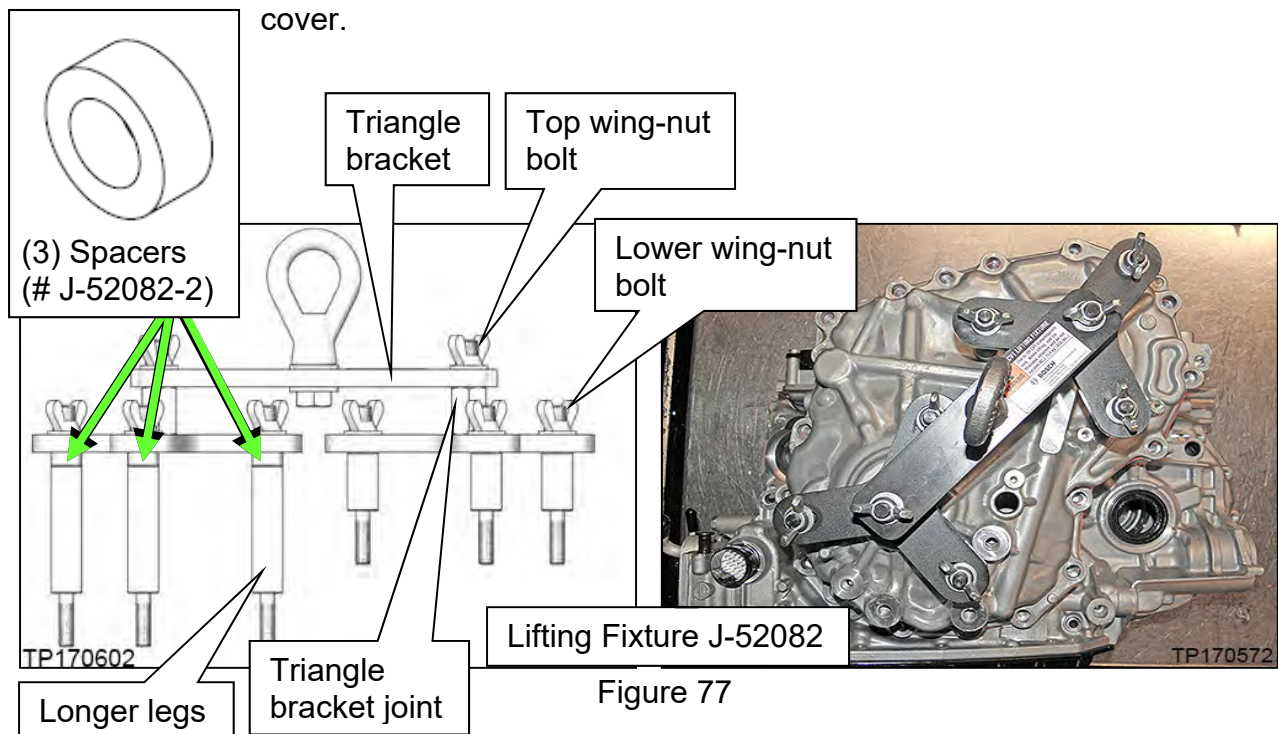

Figure 76

NOTE: Install and tighten by hand only.

- Loosen all of the wing-nut bolts on the Lifting Fixture.
- Confirm that three (3) spacers (# J-52082-2) are present between the longer legs and triangle bracket as shown in Figure 77.
- Install the Lifting Fixture to the CVT case at the six (6) bolt holes shown in Figure 76.
- Tighten the wing-nut bolts on the Lifting Fixture finger tight in the following order:
 - 1) Tighten the lower six (6) wing-nut bolts.
 - 2) Tighten the two (2) joint to triangle brackets.
 - 3) Tighten the top two (2) wing-nut bolts, and then proceed to step 57 on the next page.

CAUTION: Do not cross thread the bolts when attaching to the CVT side cover.



Rogue Lifting Fixture procedure (continued)

57. Install the two CVT Assembly Guide Pins (J-51959 - Guide Pins) as shown in Figure 78 and Figure 79.

- The Guide Pins must be located next to the dowel pins.

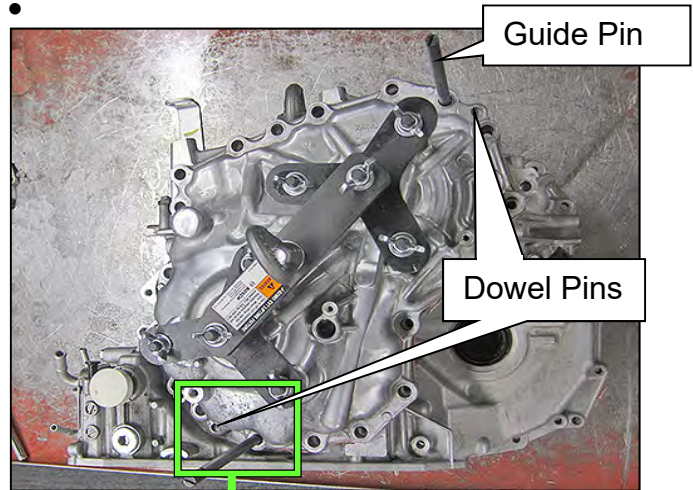

Figure 78

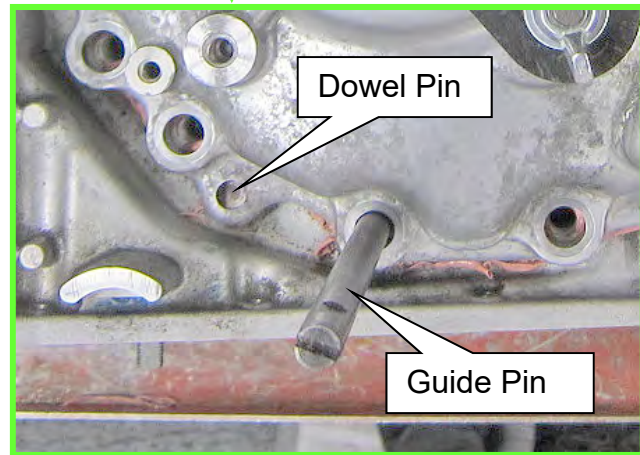

Figure 79

NOTE: The following steps on the next page apply to both Altima and Rogue.

58. Raise the Lifting Fixture so that the CVT assembly weight is mostly supported by the Lifting Fixture and just slightly raised off of the work surface.

59. Loosen the side cover with a slide hammer at the three points (tool location marks) shown in Figure 80.

- Rotate between the 3 locations on the side cover until the CVT case separates from the sub-assembly; this can take more than one rotation to loosen sealant.

CAUTION: DO NOT use a pry-bar, chisel, etc. to separate the side cover from the CVT case.

NOTE: Apply rust penetrant to the two dowel pins as needed.

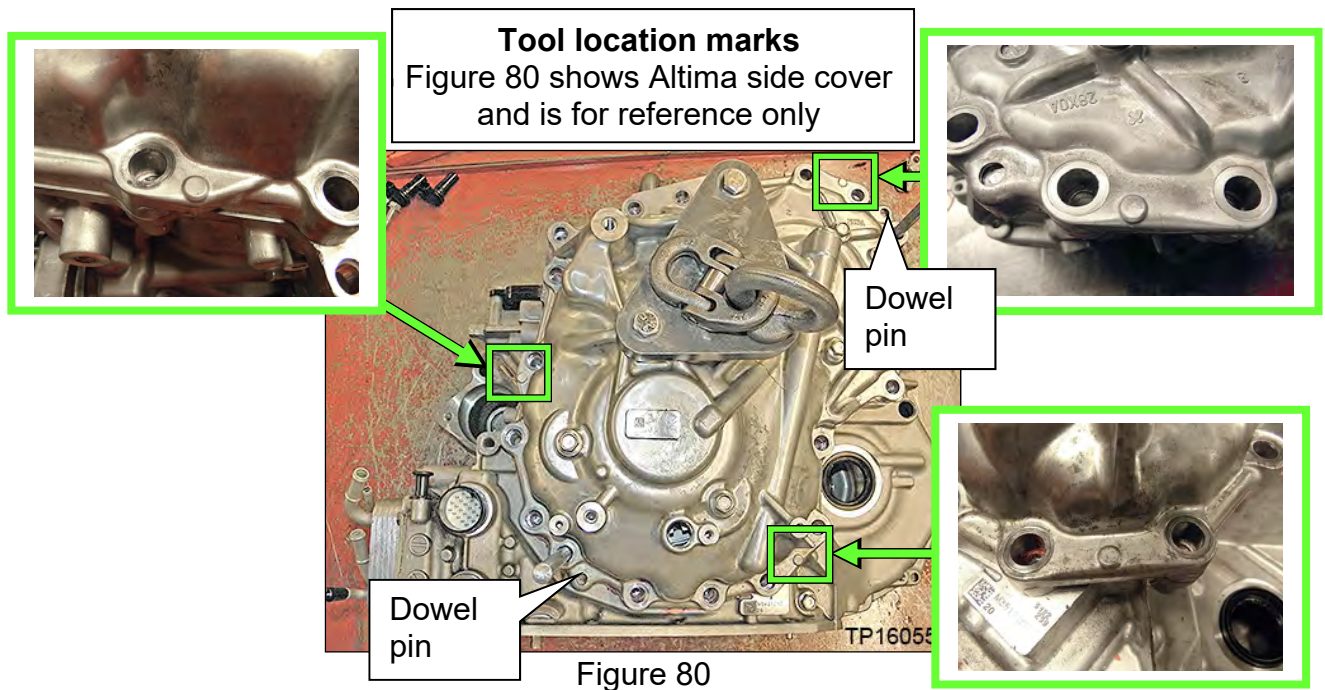

60. Raise the Lifting Fixture to remove the “side cover with pulleys and belt sub-assembly” (sub-assembly) from the CVT case (Figure 81).

CAUTION: Make sure the primary speed sensor is removed from the sub-assembly.

- Speed sensor will be reused.
- **DO NOT** discard speed sensor.
- This sub-assembly **will not** be reused.

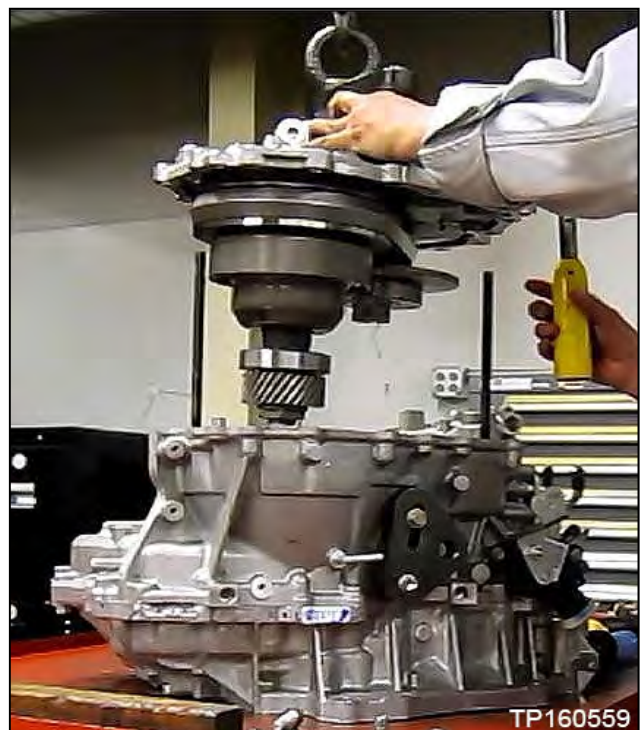

61. Remove the lifting fixture from the sub-assembly.

- For Rogue re-install all six (6) original bolts into the old sub-assembly.

62. Thoroughly clean the mating surfaces of the CVT case (Figure 82) that the sub-assembly was just separated from (a plastic scraper can be used).

- Confirm that dowel pins have remained in the CVT case. If not, remove them from the sub-assembly and relocate back to the CVT case.

NOTE: The Guide Pins can be temporarily removed for cleaning purposes.

CAUTION:

- DO NOT use sanding discs, similar abrasive tools, or metal blades.
- Use brake spray or equivalent solvent and lint-free towels only.
- Make sure brake spray or solvents used are compatible with local regulations
- Prevent debris from entering in the CVT.
- Make sure rust and debris have been cleaned off of dowel pins and receiving holes.

63. Replace the O-ring on the CVT case side with a new one from the PARTS KITS REFERENCE TABLE; discard original O-ring (Figure 83).

- Coat the O-ring with CVT fluid before installing.

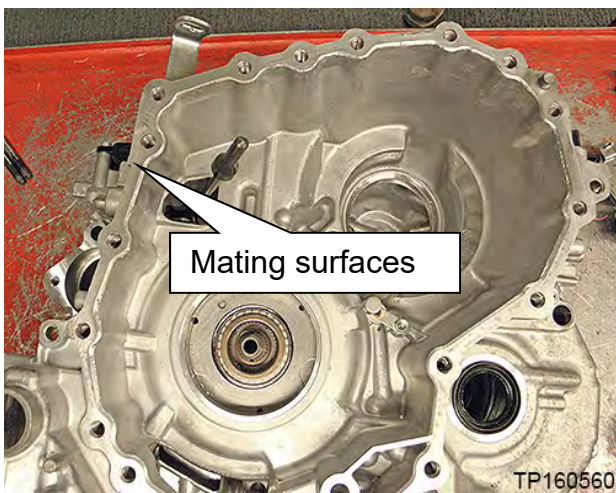

Figure 82

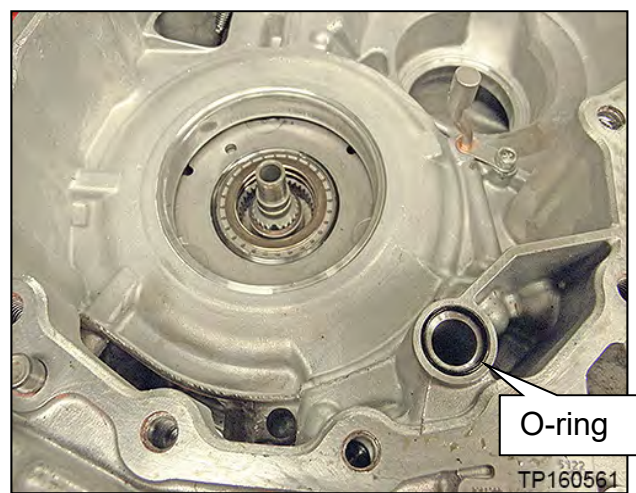

Figure 83

64. Remove the thrust bearing from the planetary carrier plate (Figure 84).

- **Thrust bearing will be re-used. DO NOT discard.**

CAUTION: If not found on the planetary carrier plate, the thrust bearing may still be attached to the primary pulley.

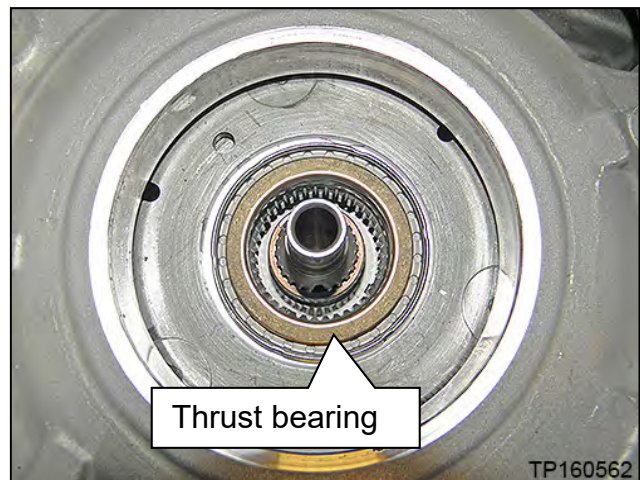

Figure 84

65. Rotate the shift select lever counter clockwise to the “L” range position (Figure 85), so that the park pawl is at its lowest position (Figure 86).

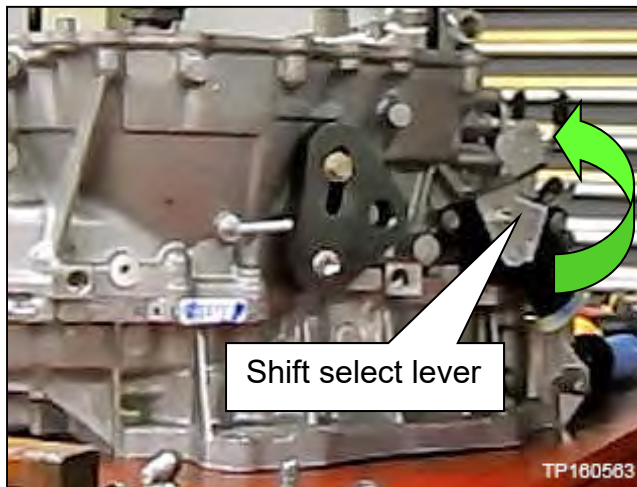

Figure 85

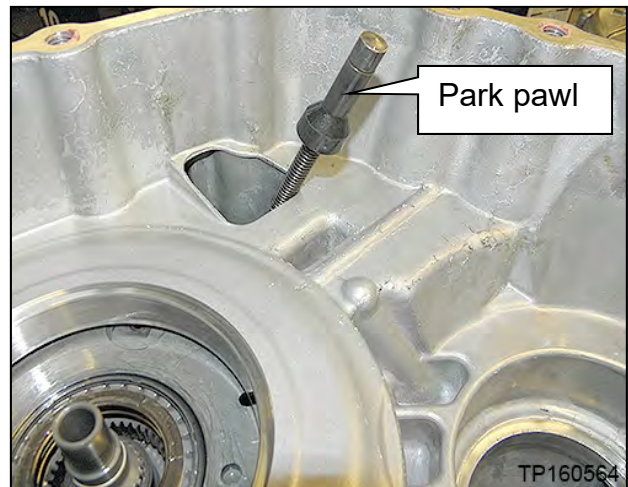

Figure 86

66. Attach the appropriate Lifting Fixture to the new sub-assembly, and then raise sub-assembly out of the shipping box.

- **For Rogue ONLY**, first remove the six (6) bolts from the new sub-assembly and then remove their O-rings before installing Lifting Fixture.
 - These bolts will be reused.
 - These O-rings will not be reused.

CAUTION: Do not cross thread the side cover holes when installing the Lifting Fixture. Always start the bolts by hand.

- Refer to Altima (page 37) or Rogue (page 39) Lifting Fixture procedures for correct Lifting Fixture installation.

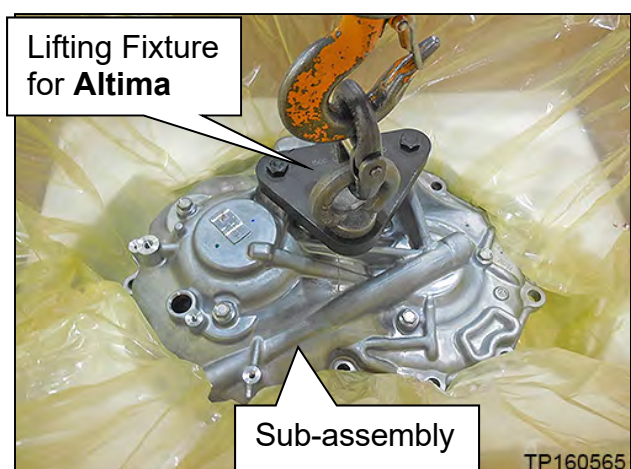
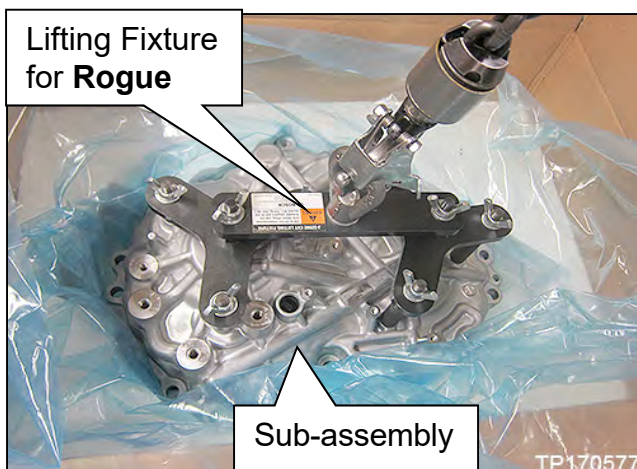

Figure 87

67. Apply one continuous 2.0 mm diameter bead of sealant along the center of the CVT case side mating surface (Figure 88).

Sealant:

- Loctite 5460 (See the Parts Information section of this bulletin)
- Color: Pink

IMPORTANT:

- Confirm that the mating surfaces are clean before applying sealant.
- Make sure that the starting point and the ending point of the sealant is between two bolt holes. Overlap both ends of the bead by 3 – 5 mm.

CAUTION: Be careful not to contact or contaminate the sealant. If the sealant has been disturbed or contaminated in any way before case assembly, thoroughly clean the mating surfaces of the CVT case and re-start from step 67.

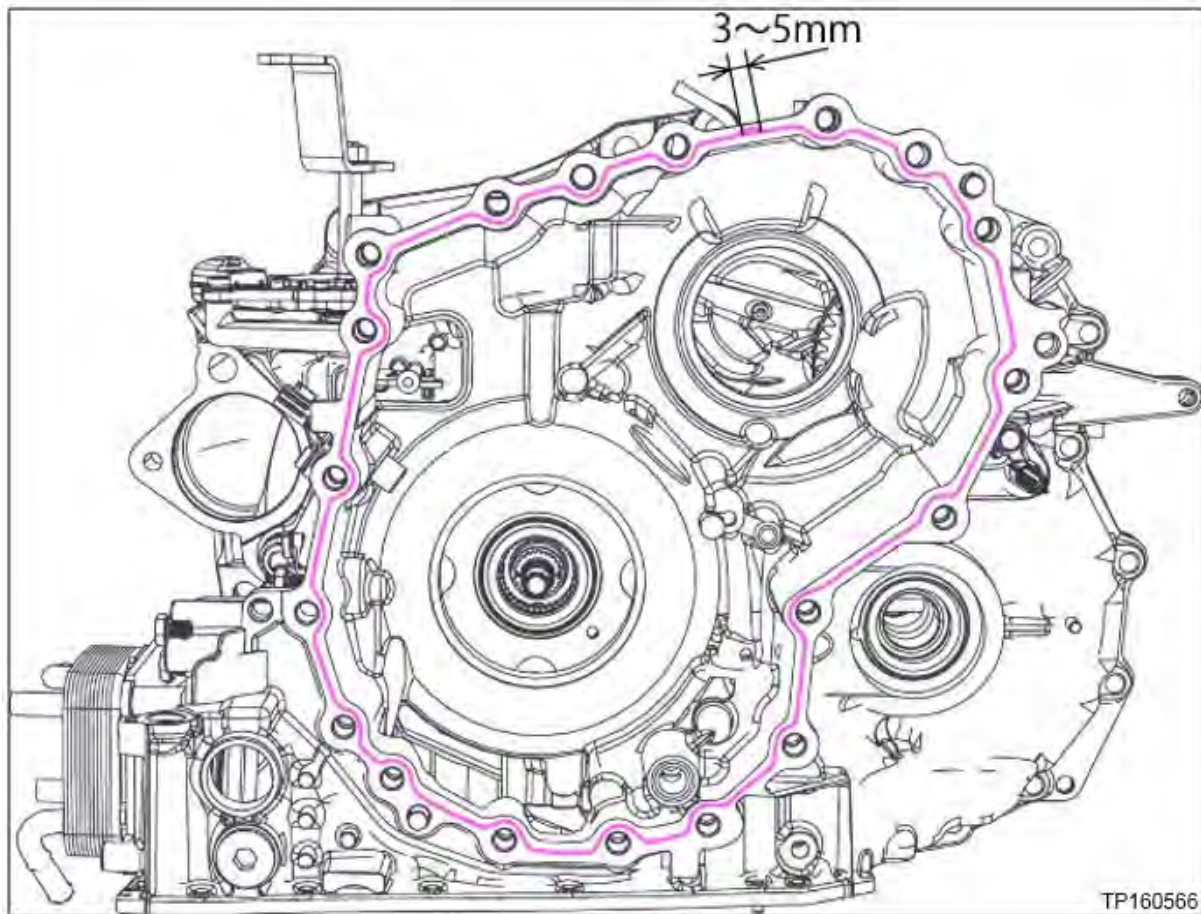

Figure 88

68. Install the original thrust bearing on the primary pulley of the new sub-assembly part (Figure 89).

IMPORTANT: The thrust bearing surface must lay flush with the primary pulley. Any additional height will affect the total end play that is measured later in this procedure.

CAUTION: The thrust bearing has two sides. Reference Figure 89 for bearing orientation.

- Apply a small amount of petroleum jelly or equivalent to the original thrust bearing to hold it in place on the primary pulley.

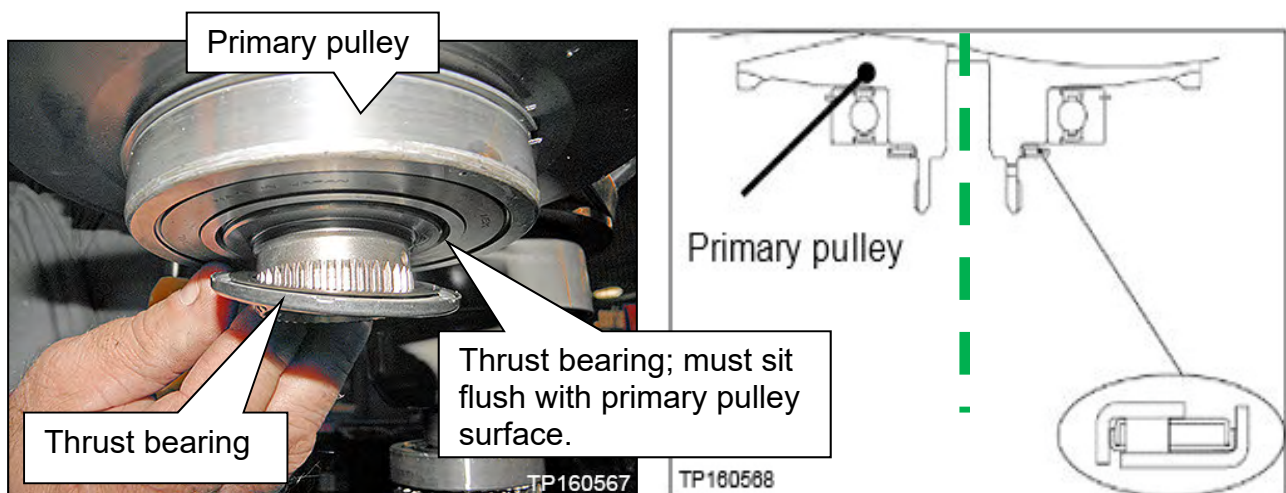

Figure 89

69. Coat the primary pulley bearing, secondary pulley gear teeth and the secondary bearing with CVT fluid prior to installation (Figure 90).

CAUTION: Do NOT drip any CVT fluid onto the sealant.

The following Figures are for reference only and may or may not have the sealant in place, or have the old sealant removed. Clean the surfaces and apply sealant when and where instructed.

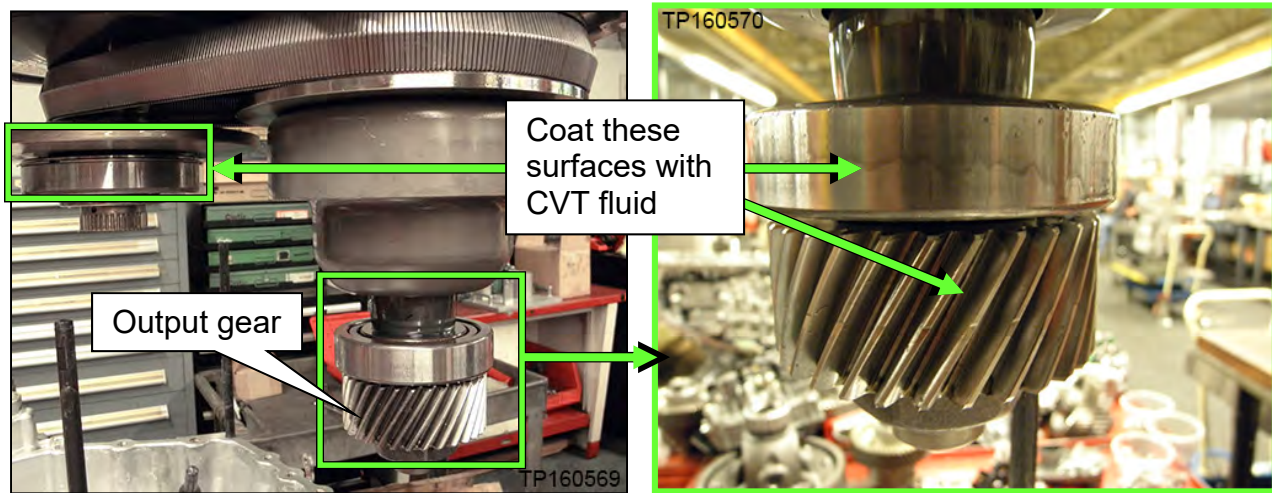

Figure 90

70. While lowering the sub-assembly, route the Guide Pins into the appropriate CVT bolt holes one at a time (the Guide Pins are different lengths for easy assembly).

IMPORTANT: Do NOT allow the output gear to contact the lubrication tube when the side cover is positioned over the guide pins (Figure 91).

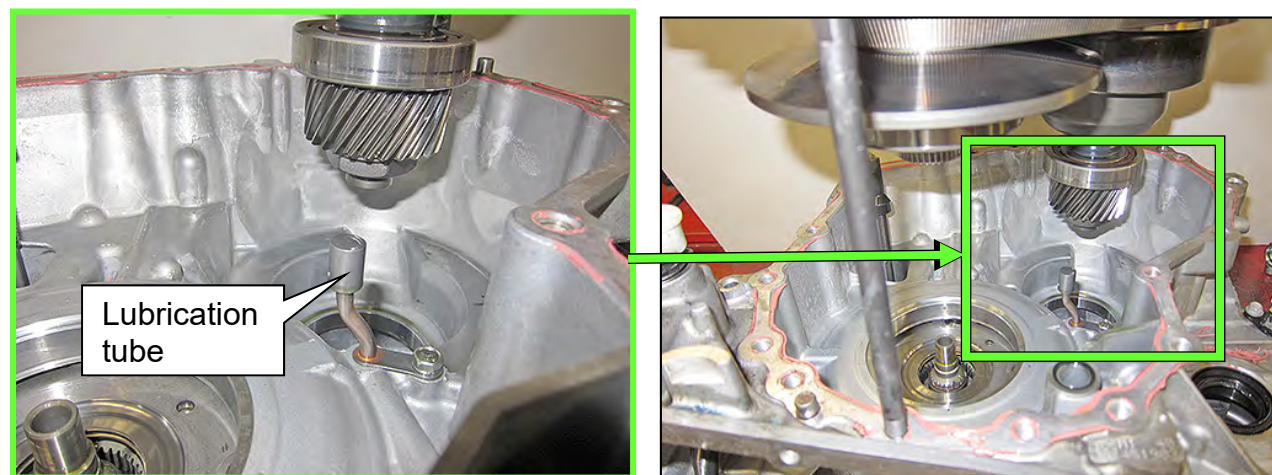

Figure 91

IMPORTANT:

Before continuing, it is recommended that you review and understand the instructions on pages 47 to 51.

The sub-assembly will lower into the CVT case without applying extra vertical force.

IF THE SUB-ASSEMBLY DOES NOT LOWER COMPLETELY,  **!** PHYSICAL INTERFERENCE IS PRESENT.

Key Technique: Raise to remove weight on interference, adjust as necessary, and then lower again.

Use the “visual gap size” below (Figure 92 and Figure 93), between the sub-assembly and the CVT case, to determine the cause of interference.

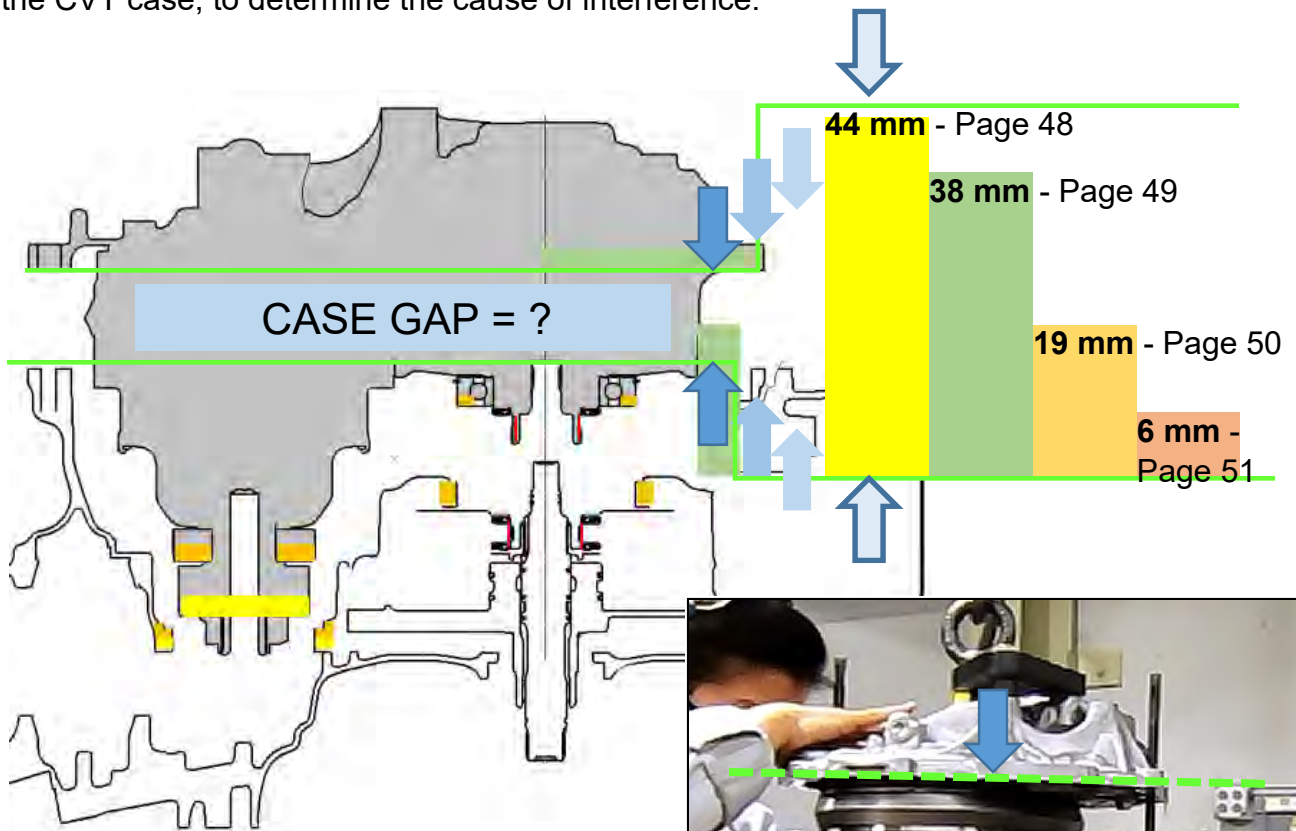

Figure 92

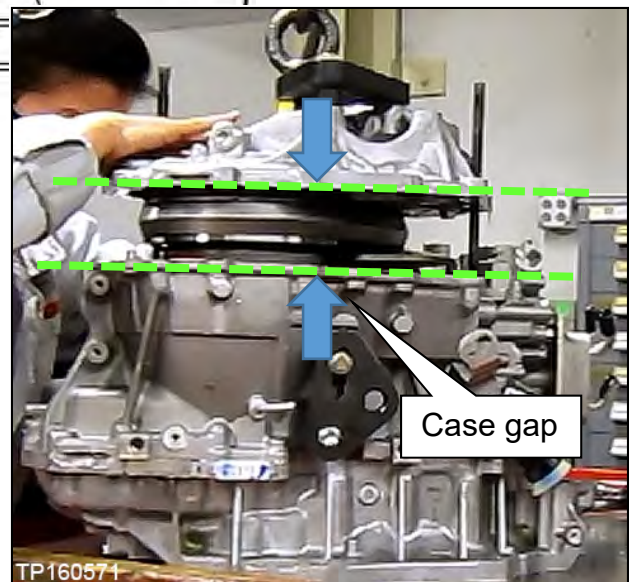

Figure 93

71. Carefully lower the Lifting Fixture to install the sub-assembly into the CVT case as follows:

- While visually looking down into the bore (Figure 95) to confirm that the output gear is clearing the CVT case bearing bore,
 - a. Level the sub-assembly by placing hands on top to guide it into the CVT case.
 - b. Lower the sub-assembly until a gap of **38 mm (1.5 inch)** is present to the CVT case (Figure 98 on page 49) and then proceed to step 72.
 - If the sub-assembly will not lower any farther than 44 mm (1.75 inch) the output gear has not cleared the bearing bore (Figure 94).

Sub-assembly will not lower past 44 mm (1.75 inch)?

- Interference is present between the output gear and bearing bore.

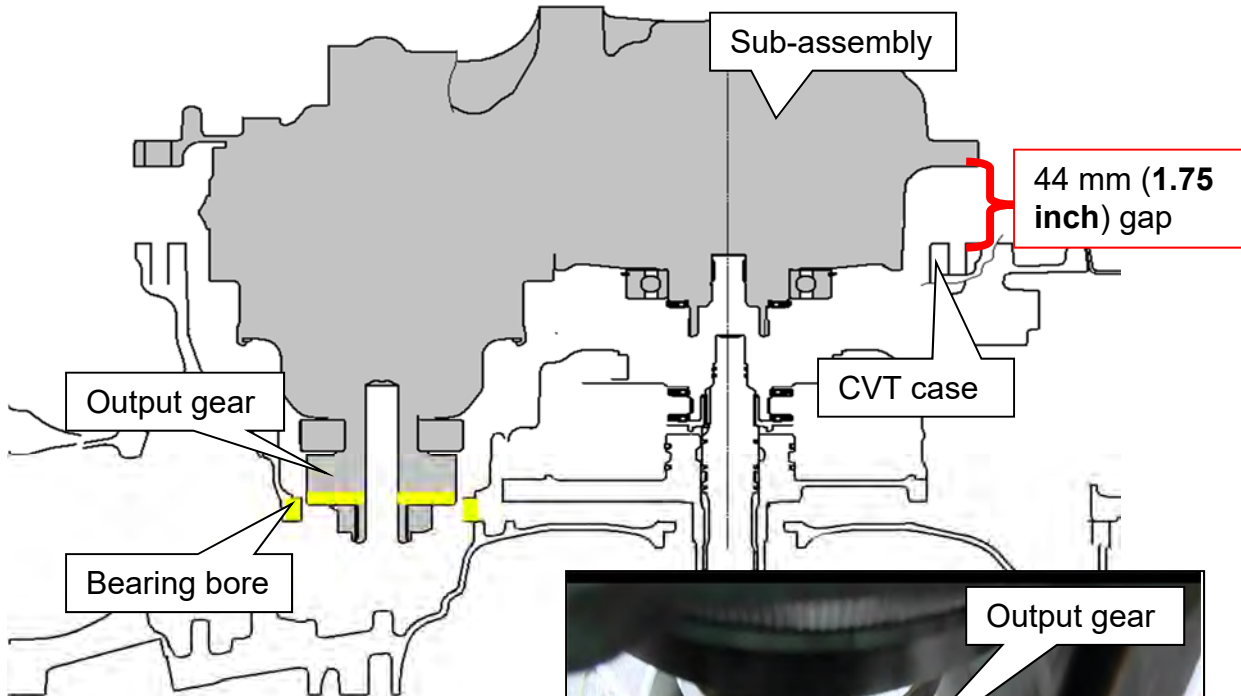

Figure 94

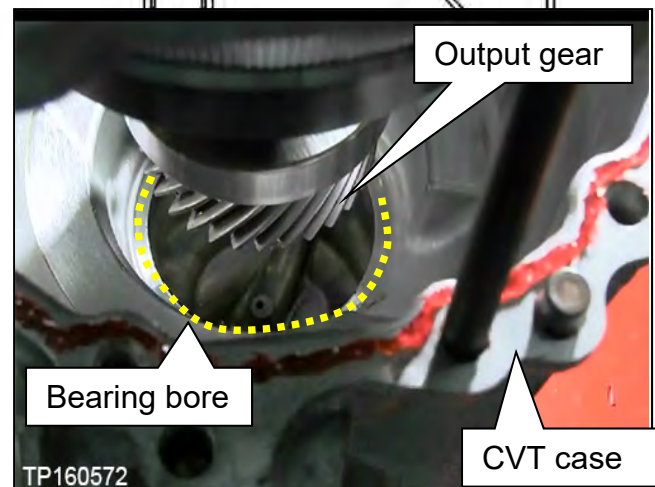



Figure 95

CAUTION: In the following steps be careful not to contact or contaminate the sealant. If the sealant has been disturbed or contaminated in any way before case assembly, remove the sealant completely and re-start from step 67 on page 44.

72. Align the parking rod with the parking pawl as follows:

IMPORTANT: Perform step 72 while the sub-assembly has a **38 mm (1.5 inch)** gap to the CVT case (Figure 98).

- a. Rotate the shift select lever clockwise on the side of the CVT to adjust the park rod to the highest position.
- b. Use a magnet, or similar tool, to align the park rod in the CVT case ( in Figure 97) with the opening in the parking pawl ( in Figure 96) in the side cover.

NOTE: If the parking rod is not located correctly it will keep the case from lowering.

The following Figures are for reference only.

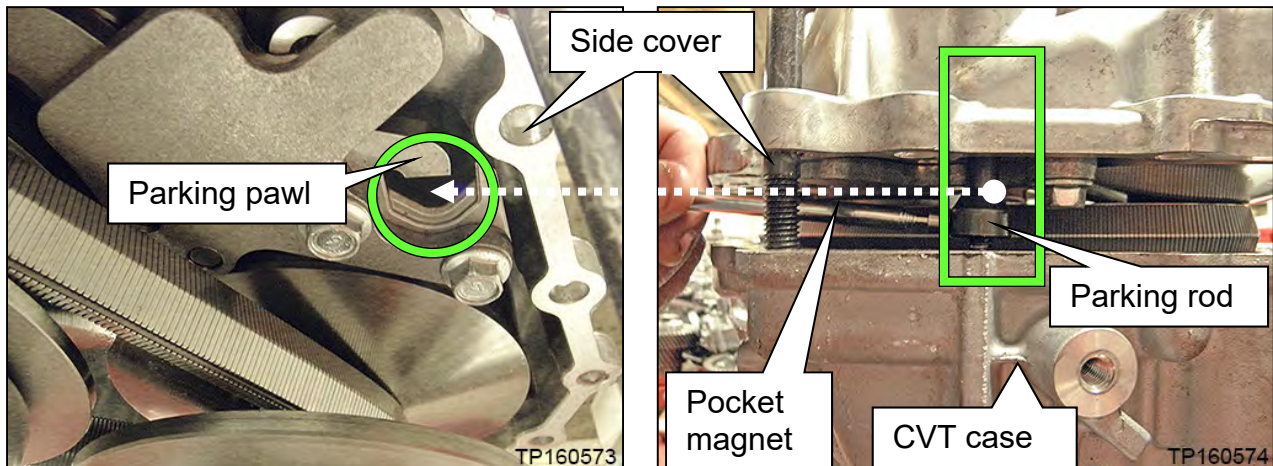

Figure 96

Figure 97

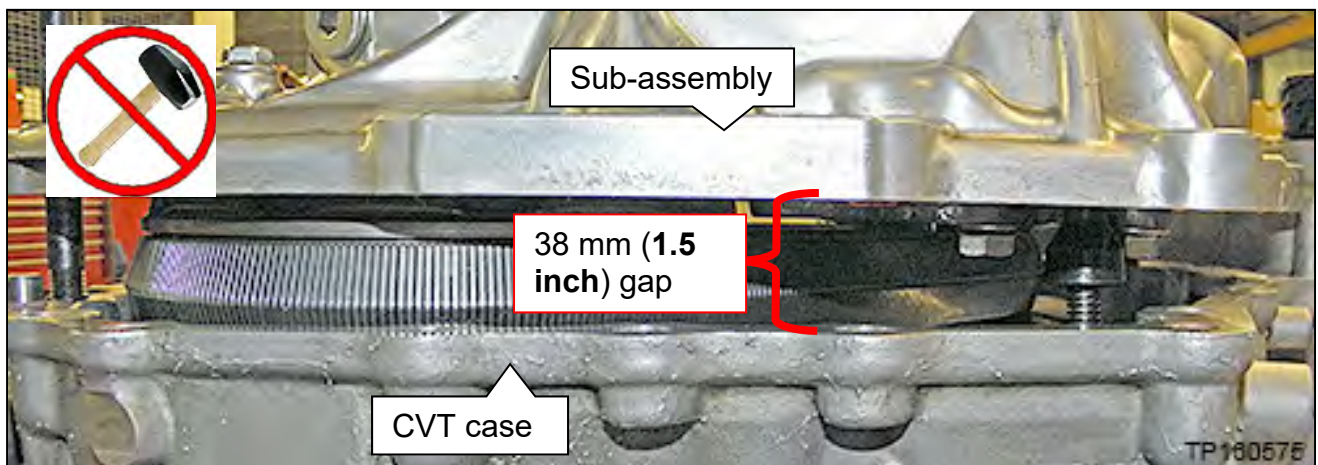

Figure 98

73. Continue to slowly lower the sub-assembly into the CVT case.

- If the primary and the secondary pulley bearings do not align properly with their bores (Figure 99) or are at an angle, a **gap of 19 mm (0.75 inch)** may be present.
 - As needed, level the sub-assembly as it is lowered into the CVT case to help the primary and the secondary pulley bearings align in their bores.
 - MINOR LEVELING ADJUSTMENTS with limited weight on the sub-assembly will help the installation. **Vertical force is not needed.**
 - Once the sub-assembly is LEVEL the primary and the secondary pulley bearings will smoothly align while lowering.

Sub-assembly will not lower past 19 mm (0.75 inch)?

- If this occurs Do NOT force sub-assembly into case.
 - a. Raise the sub-assembly slightly.
 - b. Level the sub-assembly (visually check the gap between case and sub-assembly side cover and confirm that it is even all around).
 - c. Gently lower the sub-assembly.
 - d. Gently shake the sub-assembly horizontally, lower, raise and repeat as needed to help align.
 - e. Lower to clear dowel pins to 6 mm (0.25 inch).

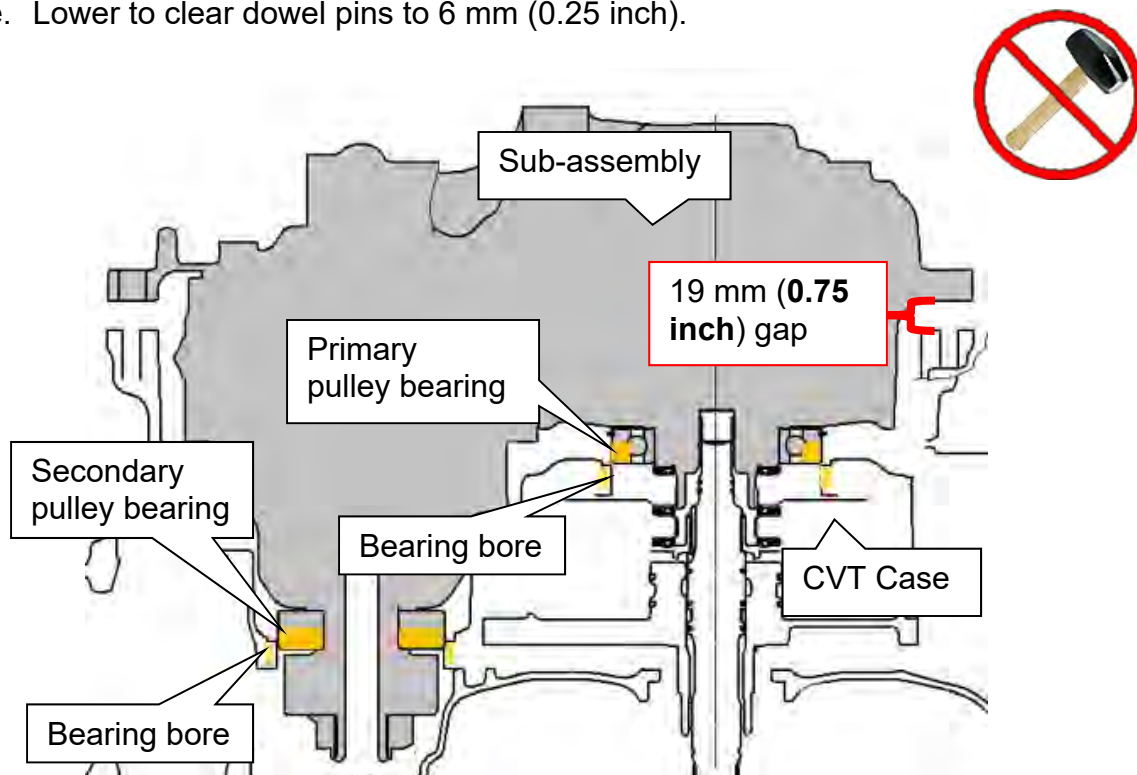

Figure 99

IMPORTANT: In the following steps the case halves must sit flush against each other without a gap before installing the bolts. The bolts CANNOT be used to draw the cases together. DO NOT APPLY VERTICAL FORCE.

74. Once the dowel pins are cleared, ease the sub-assembly down onto the CVT case until the case halves are flush.

- Confirm the dowel pins are clean and aligned and are not catching on the sub-assembly case cover.

WARNING: Be careful not to get fingers caught between the CVT case and sub-assembly when seating.

Sub-assembly will not lower past 6 mm (0.25 inch)?

If the sub-assembly will not lower past **6 mm (0.25 inch)**, the primary pulley splines are not aligned.

- If this occurs Do NOT force sub-assembly into case.
 - a. Raise the sub-assembly slightly so the weight is not completely on the primary pulley splines.
 - b. Slightly rotate the primary pulley through the bottom of the CVT and then lower the sub-assembly.
 - c. Repeat as needed.

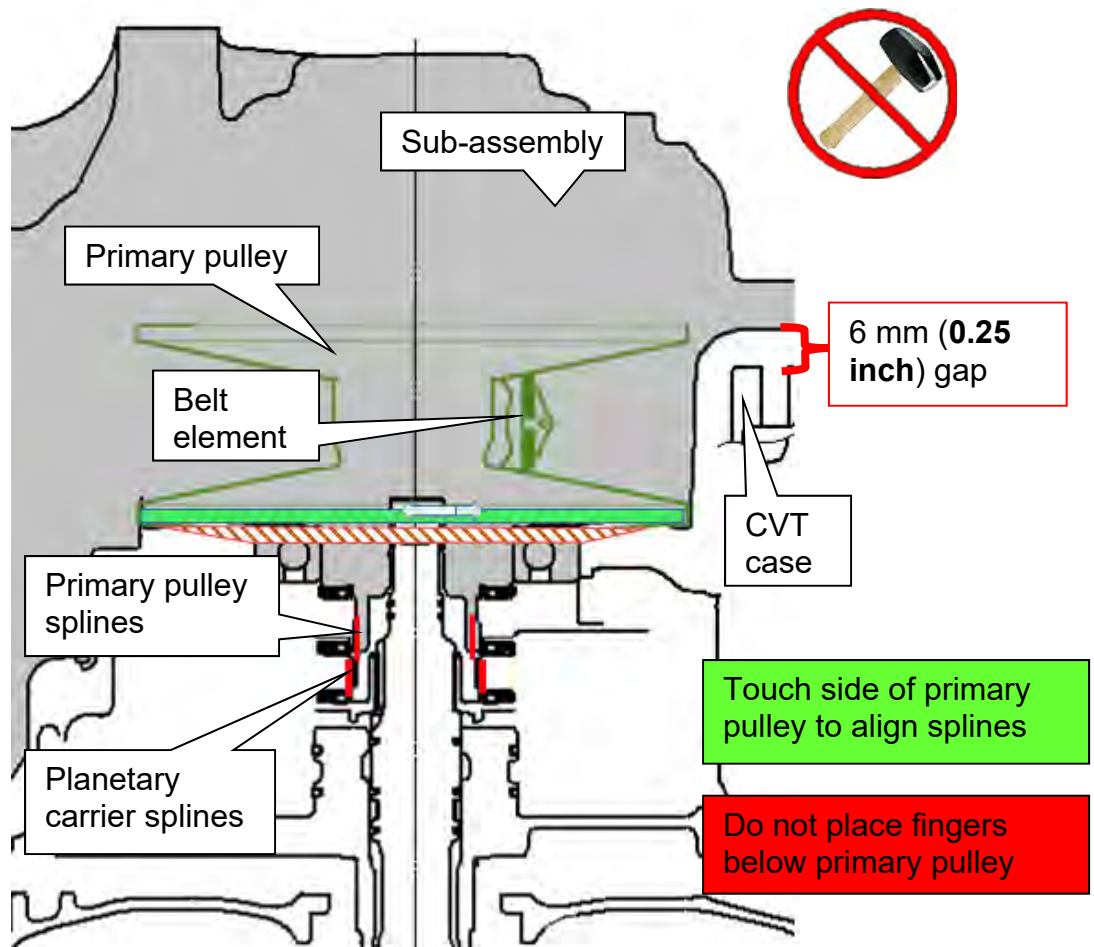

Figure 100

75. Confirm the parking rod operation as follows:

- a. Rotate the shift select lever counter clockwise and confirm that all detents for each of the P-R-N-D-L are felt.
- b. Rotate the lever clockwise to return the rod back to the **P** position.
- c. Are all of the detents felt?

➤ **YES:** Proceed to step 76.

➤ **NO:** If the lever does not rotate or if all detents are not felt:

- 1) Raise the sub-assembly and remove all sealant.
- 2) Restart from step 67 on page 44.

Rotate the shift select lever

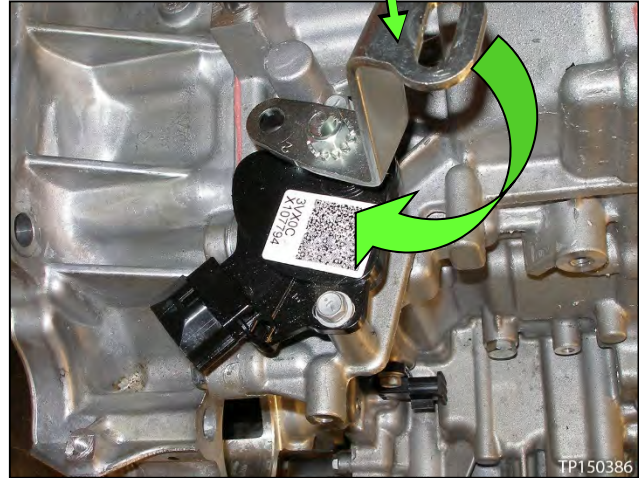

Figure 101

76. Remove the guide pins.

77. Install the new side cover bolts for sub-assembly to the CVT case (Figure 102).

- Torque the first eight (8) bolts marked as ● in the sequence numbered in Figure 102 below, and then torque the rest of the bolts in a clockwise direction.
- Bolt torque: 45 N•m (4.6 kg-m, **33 ft-lb**) 19 pieces.

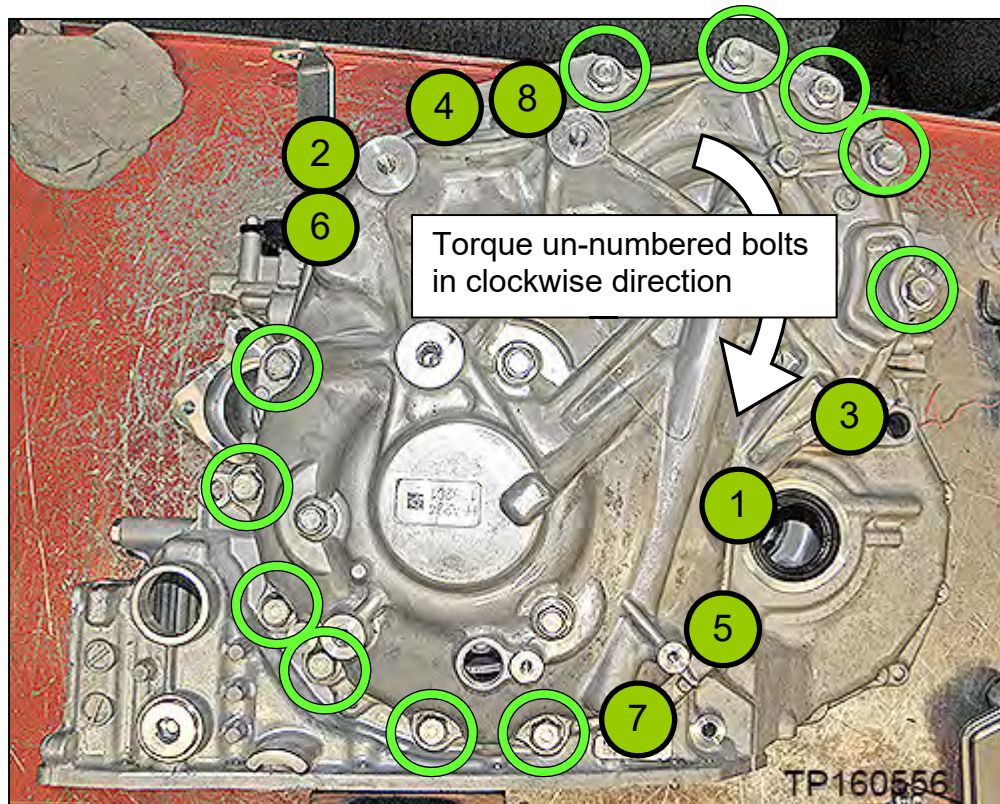

Figure 102

78. Remove the lifting fixture.

79. For Rogue ONLY, Install six (6) new O-rings, from the Parts Kits Reference Table, to the six (6) new pulley bearing retainer bolts that were removed from the new sub-assembly on page 43, step 66.

- **All other models, proceed to step 81**

80. Install the six (6) new pulley bearing retainer bolts finger tight.

- Do not use tools to install.

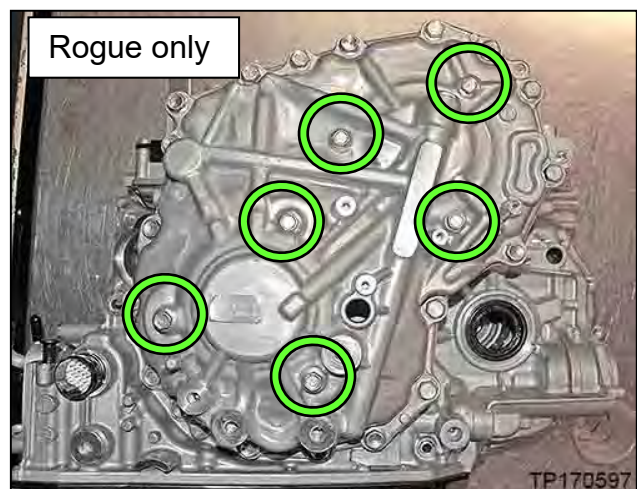

Figure 103

81. Confirm the rotational smoothness of the primary pulley as follows:

- a. With clean hand, access the primary pulley from the bottom of the CVT.
- b. Rotate the primary pulley by hand and confirm that the characteristic is the same as previously checked at step 49 on page 35, prior to removing the original sub-assembly.
- c. Is the rotational characteristic worse than before the sub-assembly was replaced?
 - **NO:** The rotational characteristic is the same or better; proceed to step 82.
 - **YES:**
 - 1) Remove the sub-assembly from the CVT case.
 - 2) Wipe and clean the sealant completely from both the CVT case rim and side cover rim.
 - 3) Restart sub-assembly installation from Step 67 of “**Replace Side Cover – Pulleys and Belt**” on Page 44.
 - 4) Return to step 81 and recheck rotational characteristic.

82. For Rogue ONLY torque all six (6) bolts.

- **All other models, proceed to step 83.**
- Bolt torque: 28 N•m (2.8 kg-m, **20 ft-lbs**).



Figure 104

83. Install the CVT case side axle seal (Figure 105).

- Use Seal Installer J-52281 and Driver Handle J-8092.
- Apply a light coat of CVT fluid to the seal lip surfaces.

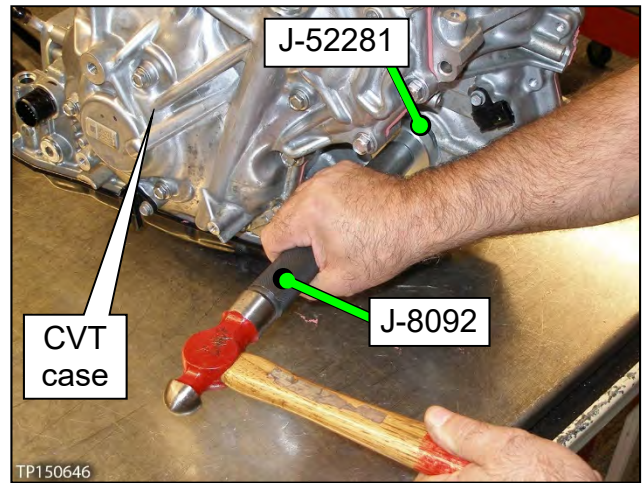

Figure 105

84. Place the CVT on the work bench with the side cover facing down on the bench

85. Remove the converter housing which was temporarily installed with three bolts.

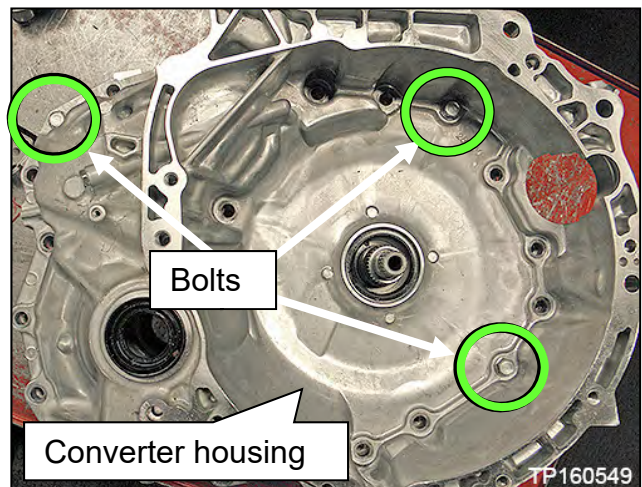

Figure 106

Clutch Total Endplay Adjustment – Thrust Bearing Selection

IMPORTANT: The clutch total endplay (Figure 107) must always be adjusted between the clutch drum and the dummy cover when a new sub-assembly is installed and is adjusted with thrust bearing thickness.

There are eight (8) thicknesses of thrust bearings available for total endplay adjustment.

- For additional information, see video # **547: “CVT Belt and Pulley Replacement”** and fast forward to minute marker **13:22**. This video is located under the TECH TRAINING GARAGE VIDEOS tab in Virtual Academy.

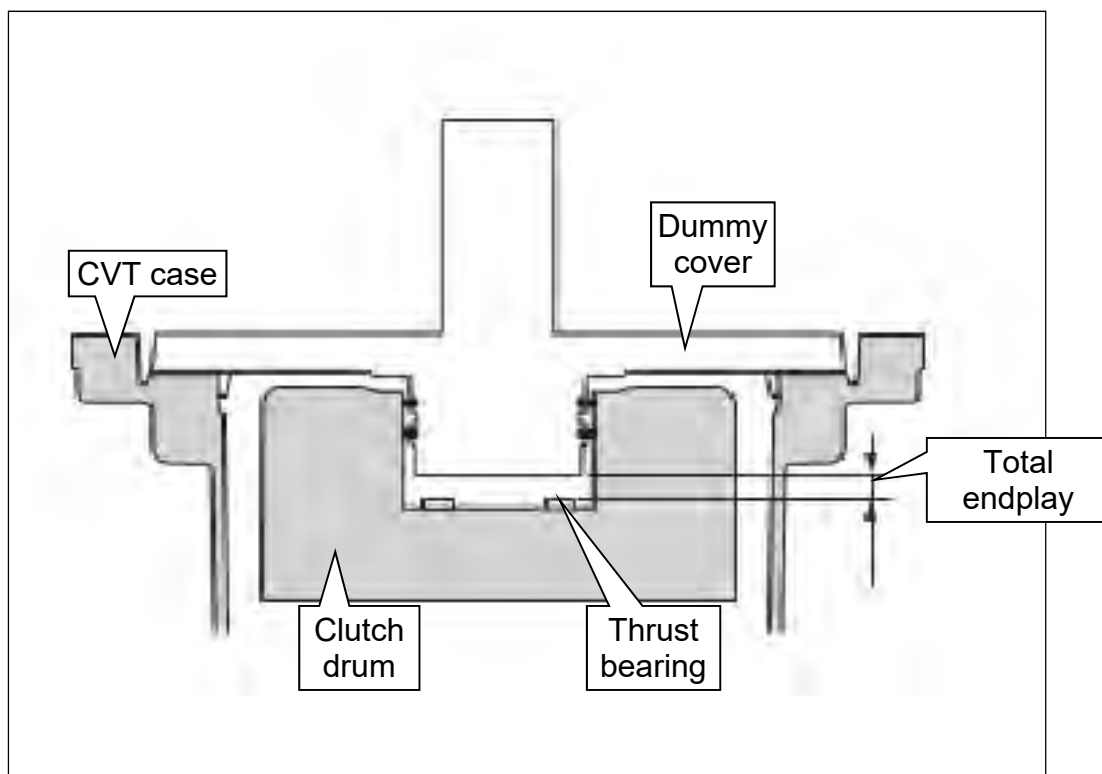

Figure 107

86. Clean and then zero the Digital Depth Gauge (part #: J-50272).

- Set Digital Depth Gauge to millimeters.

87. Clean Gauge Block J-50271.

88. Confirm the mating surfaces of the CVT case are clean.

89. Calculate the average (D) clutch assembly bore depth (Figure 108) as follows:

IMPORTANT: Measurements are required from two opposite ends to obtain the average.

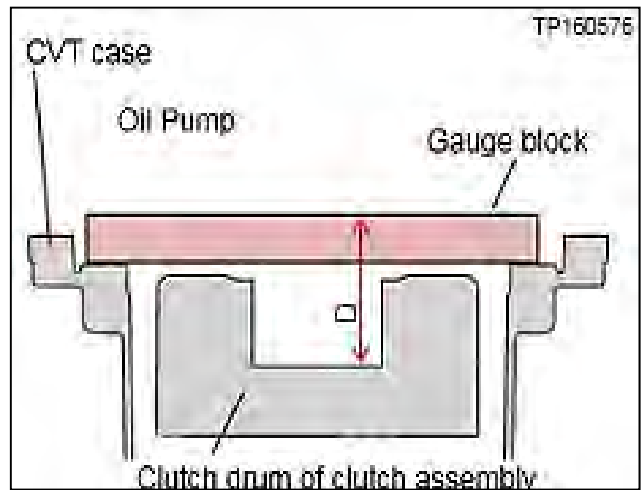

Figure 108

- a. Place the Gauge Block on the surface where the dummy cover seats, and over the clutch assembly bore (Figure 109).

IMPORTANT: This surface is lower than the CVT case to torque converter housing surface.

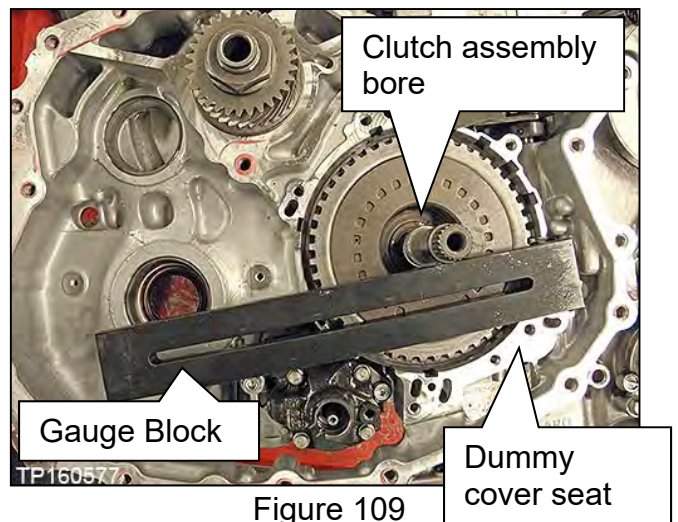

Figure 109

NOTE: The clutch assembly should sit 2-3 mm lower than the dummy cover seat (Figure 110).

- b. Confirm the Gauge Block is not sitting on the clutch assembly or against the input shaft.

NOTE: If the clutch assembly is sitting higher than the dummy cover surface, see trouble shooting **The Dummy Cover Will Not Sit Flush** on page 90.

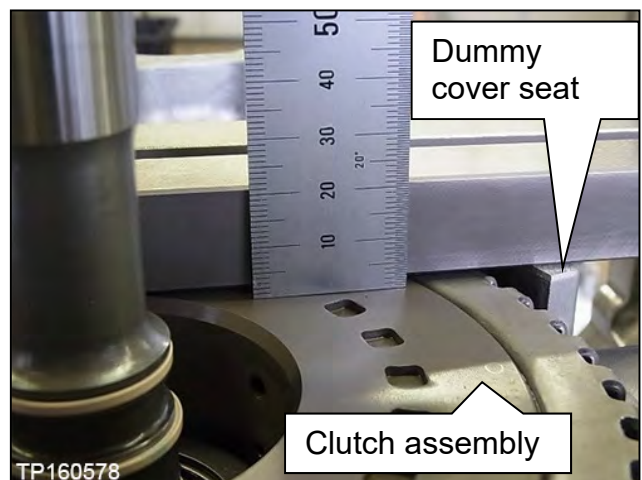

Figure 110

- c. Position the Depth Gauge on the Gauge Block (Figure 111).

NOTE: Make sure the Depth Gauge's datum level is flush with the top of the Gauge Block.

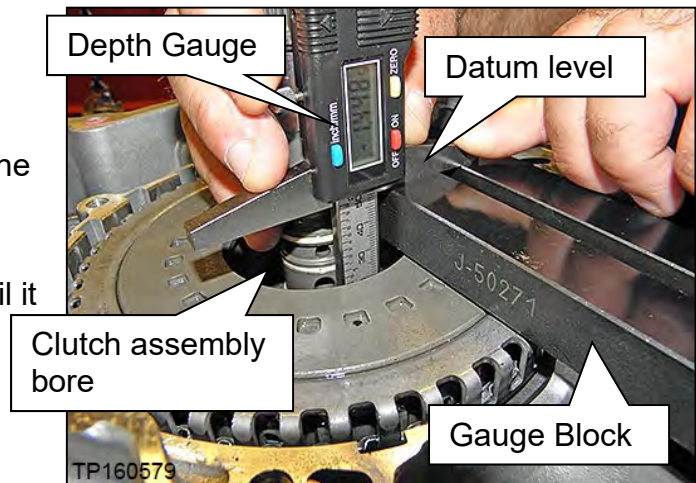

Figure 111

- d. Carefully slide the gauge down until it bottoms out on the bottom of the clutch assembly bore. Write this measurement as **D1** (use millimeters).

NOTE: Do not measure from the clutch assembly bore shown in red (Figure 112).

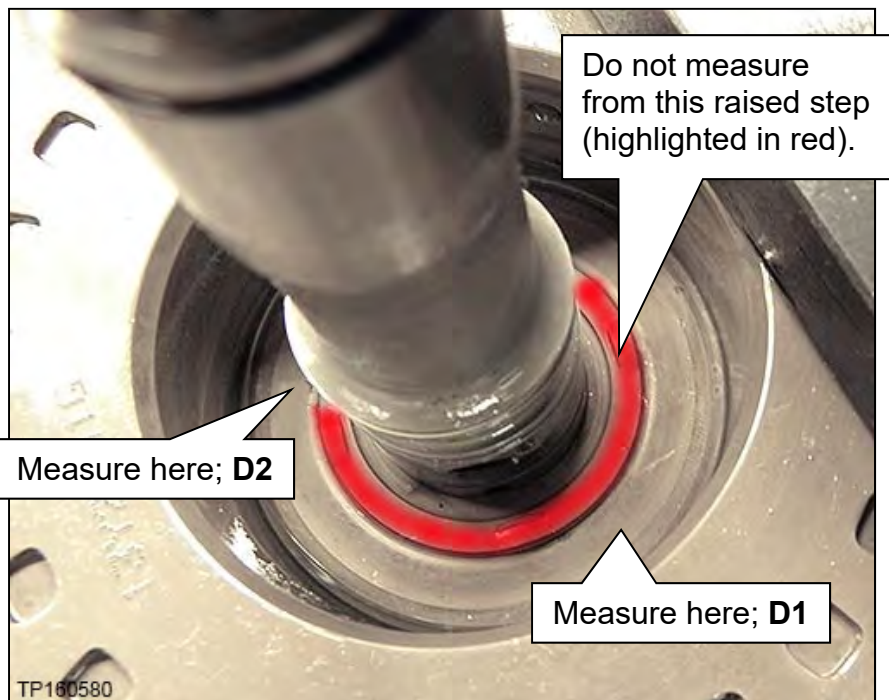

Figure 112

- e. Measure this same distance on the opposite side (180 degrees) of the clutch assembly bore and write it as **D2**.
- f. Using the formula below, calculate the average and write down the calculated value as **D**.

$$D = \frac{(D1 + D2)}{2}$$

Write the measurement for "D" here _____ mm

90. Measure the average (**H**) dummy cover height (Figure 114) as follows:

- a. Clean the dummy cover surfaces that contact the CVT case and thrust bearing (Figure 113).

CAUTION: Use brake spray (or equivalent) and lint-free towel only. Make sure the brake spray or solvents used are compatible with local regulations.

- b. Place the dummy cover upside down on a work bench, and place the Gauge Block onto the thrust bearing surface (Figure 114).

- c. Position the Depth Gauge on the Gauge Block over an outer end of the dummy cover (Figure 114).

NOTE: Make sure the Depth Gauge's datum level is flush with the top of the Gauge Block.

- d. Carefully slide the Depth Gauge down until it contacts the dummy cover surface that mates with the CVT case. Write this measurement as **H1** (use millimeters).
- e. Measure this same distance on the opposite side of the dummy cover and write it as **H2** (Figure 114).

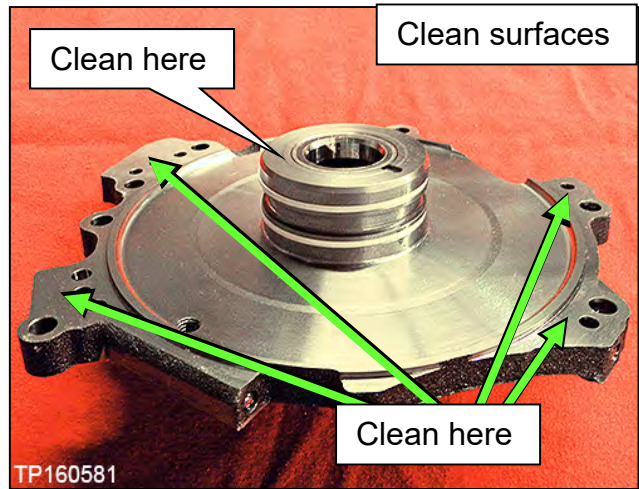

Figure 113

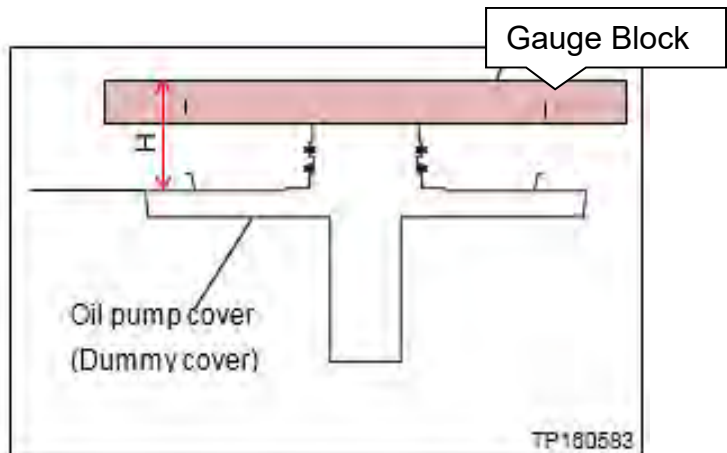
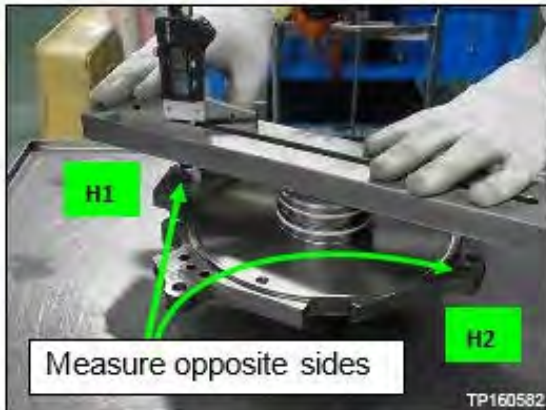

Figure 114

- f. Using the formula below, calculate the average and then write down the calculated value as **H**.

$$H = \frac{(H1 + H2)}{2}$$

Write the measurement for "H" here _____ mm

91. Choose the thrust bearing to adjust Clutch Total Endplay (**A**) as follows:

- a. Calculate **A** (Total Endplay):

Total Endplay A = D – H (This will be the thrust bearing thickness).

- Fill in the measurements below for "D" and "H" from pages 58 and 59 to calculate for "A".

D measurement _____ mm
 – H measurement _____ mm
 = **A** _____ mm

Please print this page and attach it to the repair order.

- b. Choose the appropriate bearing from Table A below, based on the Total Endplay (A) calculated on the previous page (8 thicknesses of thrust bearings are available).
Example: If **A** = 4.3 mm, it falls between the lower and upper clearances for bearing thickness 3.93 mm.
- Refer to **PARTS INFORMATION** for Thrust Bearing part numbers by thickness.
- c. Measure and confirm that the selected thrust bearing is the correct thickness before installing (Figure 115).
- d. Circle the thrust bearing part number that was selected in Table A.

Table A

PART #: 31407-	A = D - H CLEARANCE (A)	BEARING THICKNESS
1XZOB	3.87 - 4.07 MM	3.57
1XZ0C	4.08 - 4.23 mm	3.75
1XZ0D	4.24 - 4.43 mm	3.93
1XZ0E	4.44 - 4.58 mm	4.1
1XZ1A	4.59 - 4.78 mm	4.28
1XZ1B	4.79 - 4.94 mm	4.46
1XZ1C	4.95 - 5.09 mm	4.61
1XZ1D	5.10 - 5.29 mm	4.79



Figure 115

92. Install the thrust bearing flush to the clutch assembly bore as shown in Figure 116.

- Install thrust bearing in area shown in green so that it is centered by the four tabs.

CAUTION: The thrust bearing has two sides. See image below for appropriate orientation.

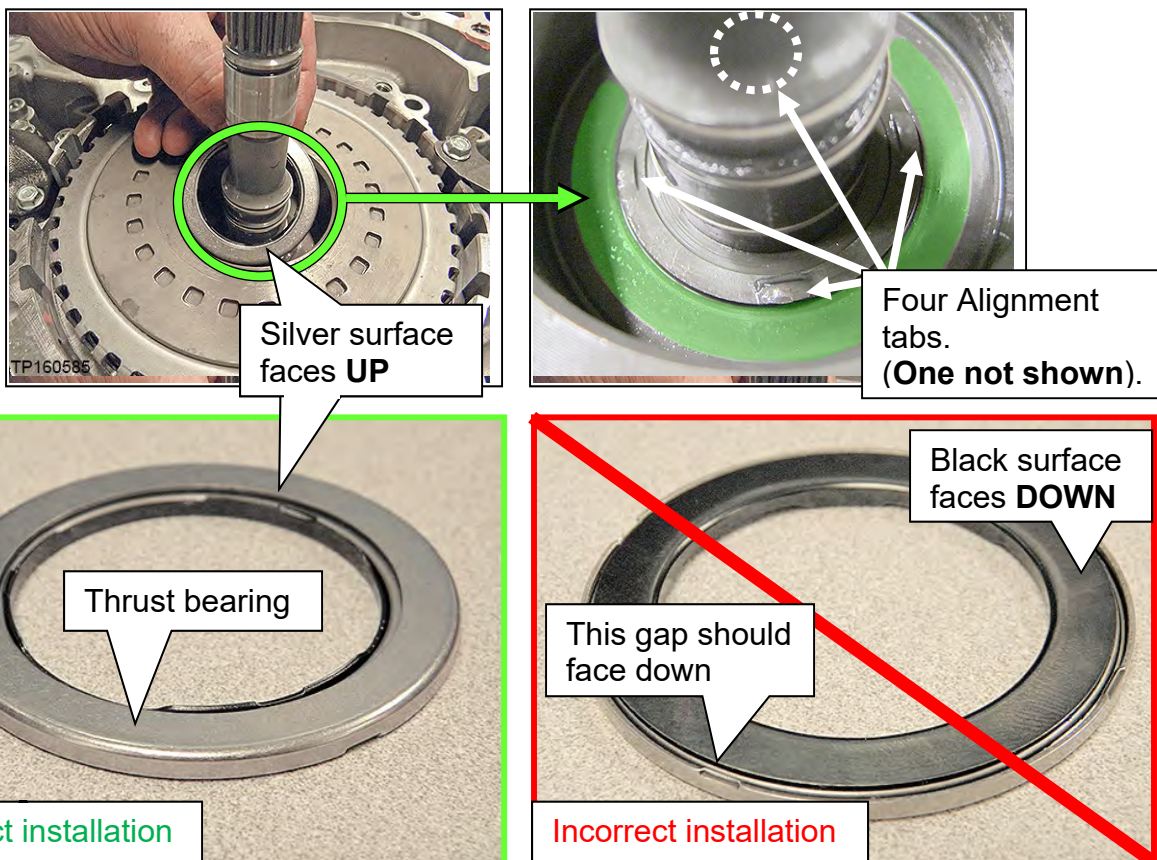

Figure 116

Clean the Converter Housing Passages

IMPORTANT: Remove as much of the CVT and cleaning fluids as possible, and clean the related parts in the following steps.

93. Remove the baffle plate and lubrication tube as follows:

- a. Remove the three bolts, and then remove the baffle plate from the converter housing (Figure 117).

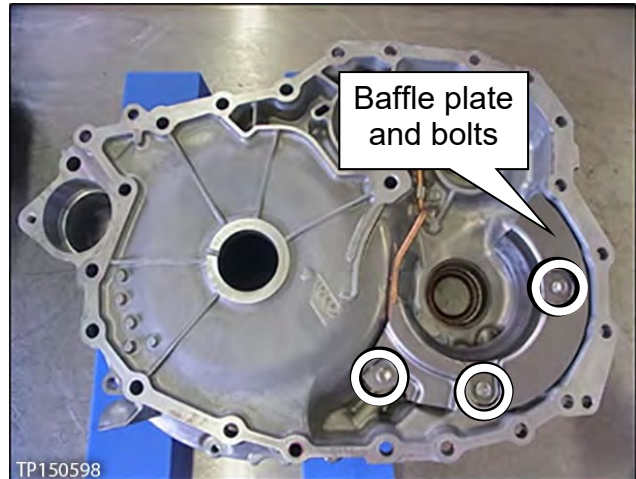

Figure 117

- b. Remove the bolt and then remove the lubrication tube and its bracket (Figure 118).

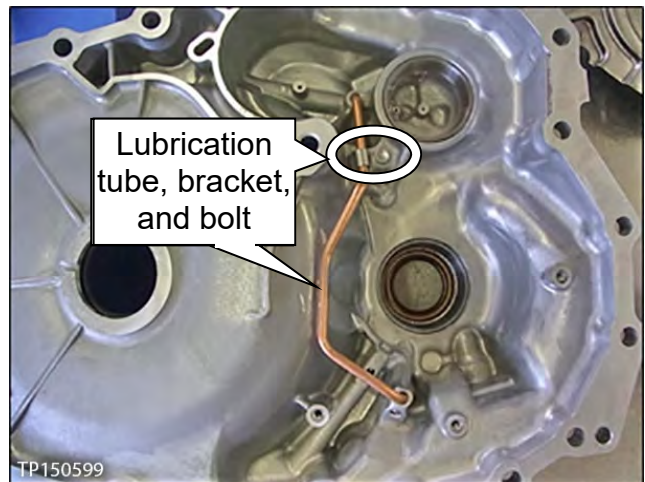
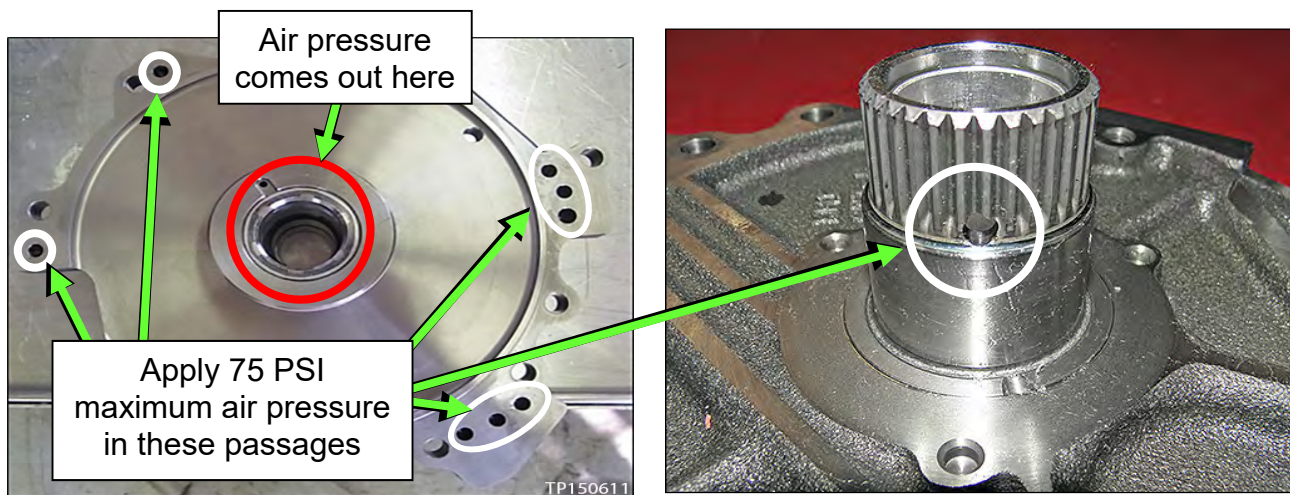
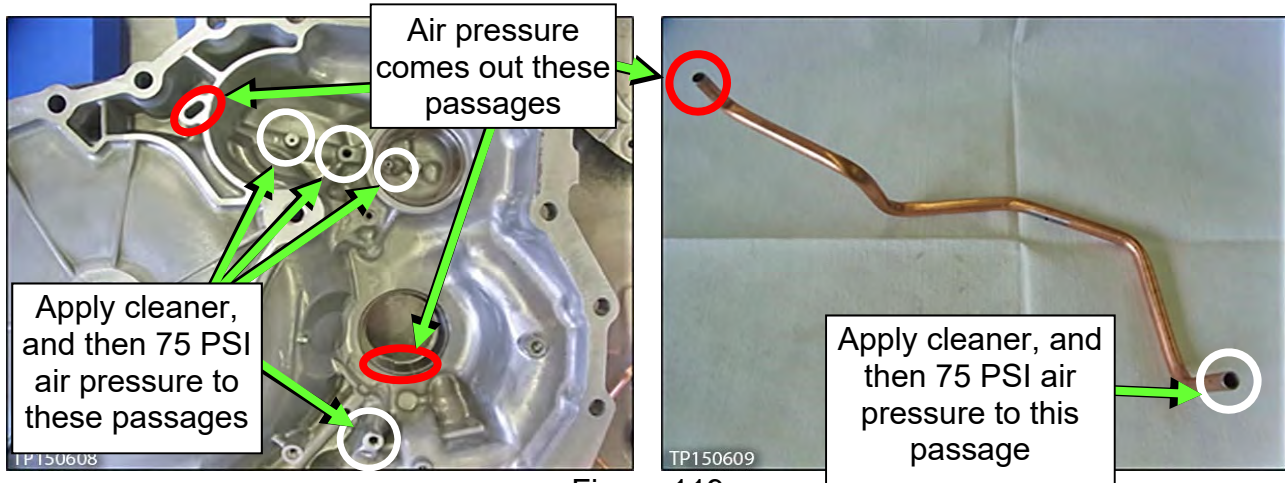

Figure 118

94. Clean the oil passages of the converter housing, lubrication tube and dummy cover with brake spray (or equivalent) where shown in Figure 119 and Figure 120 below.

NOTE: Do not stand in front of the passages shown while using compressed air.



95. Install the lubrication tube, bracket and bolt, and then the baffle plate with three bolts (Figure 121).

➤ Bolt torque: 5.9 N•m (0.6kg-m, **52 in-lb.**)

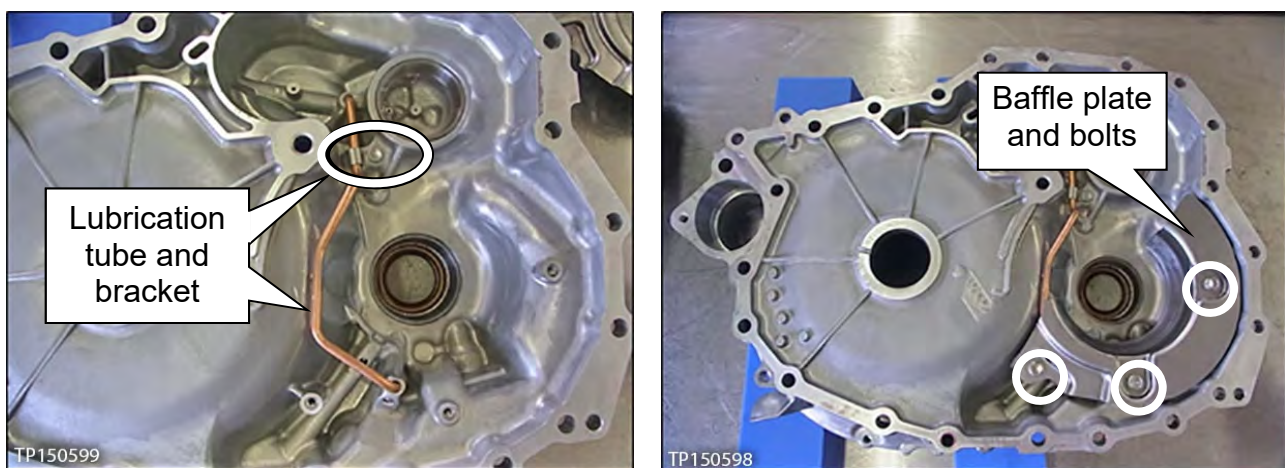

CVT Reassembly

96. Install a new torque converter seal with Seal Installer J-50818 (Figure 122).

- Place the torque converter housing flat during installation.
- Apply a light coat of CVT fluid to the seal lip surfaces.
- The torque converter housing seal will be 0.5 mm (**0.020 inches**) below the bore's surface when the seal installer bottoms out.



Figure 122

97. Is this vehicle an all-wheel drive (AWD)?

YES: Proceed to step 98.

NO: Install the torque converter housing side axle seal (Figure 123).

- Use Seal Installer J-52282 and Driver Handle J-8092.
- Apply a light coat of CVT fluid to the seal lip surfaces.
- Proceed to step 98.

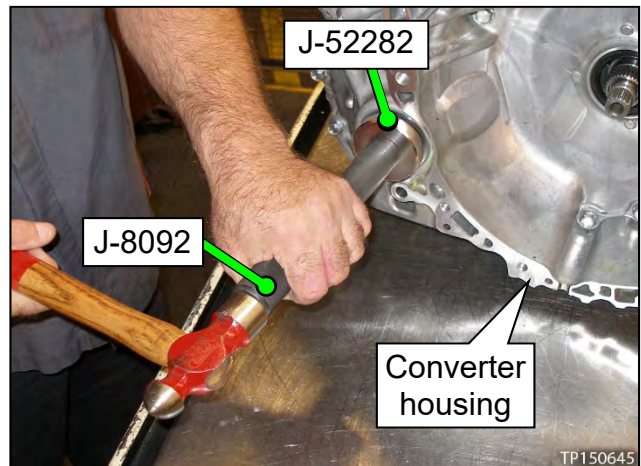

Figure 123

98. Apply petroleum jelly or equivalent to the dummy cover's lathe cut seals (Figure 124) before installing the dummy cover to the CVT case.

IMPORTANT:

- Confirm that the lathe cut seals (white seals) are in their appropriate slots. Carefully reposition seals as necessary.
- **Lathe cut seals must be in their correct positions during final assembly to prevent drivability issues.**

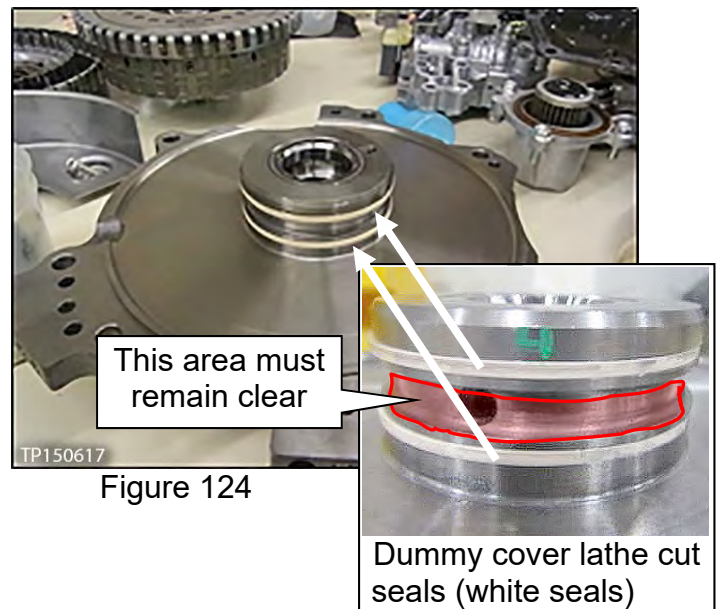

Figure 124

Dummy cover lathe cut seals (white seals)

99. Confirm that the input shaft's lathe cut seals are in the correct positions (Figure 125).

IMPORTANT:

- Lathe cut seals (white seals) must be in their appropriate slots. Carefully reposition seals as necessary.
- **Lathe cut seals must be in their correct positions during final assembly to prevent drivability issues.**

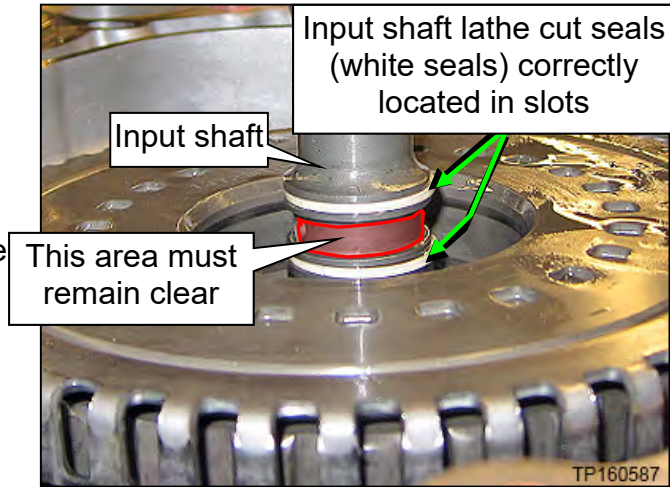

Figure 125

100. Install the dummy cover first, then baffle plate C, and then the related bolts finger tight (Figure 126).

IMPORTANT: Visually check that the dummy cover is fully seated on the CVT case. If it is not, refer to **Trouble Shooting** pages 90 – 91.

- Do not force the dummy cover into place.
- Make sure the dummy cover is fully seated before installing the bolts.
- Do not torque these bolts at this time.

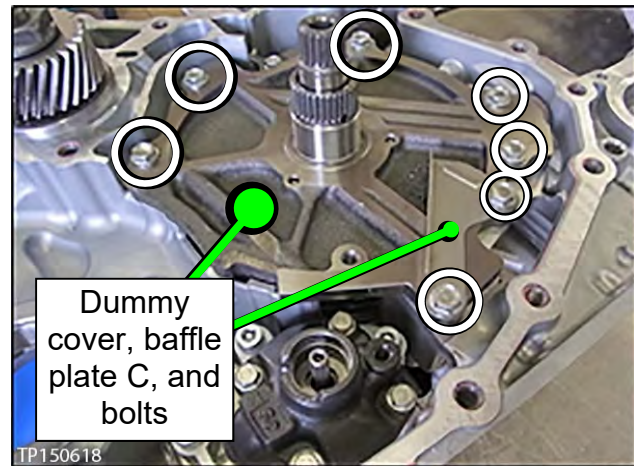

Figure 126

101. Install baffle plate B and “L” bracket with the related bolts finger tight (Figure 127).

102. Torque the bolts from steps 100 and 101 in the following order:
- a. Baffle plate B bolts: 5.9 N•m (0.6 kg- m, **52.2 in-lb.**)
 - b. “L” bracket bolts: 25.5 N-m (2.6 kg- m, 19 ft-lb). Torque **1** and then **2**.
 - c. Dummy cover and baffle plate C bolts torque: 19.0 N•m (1.9 kg-m, **14 ft-lb.**)

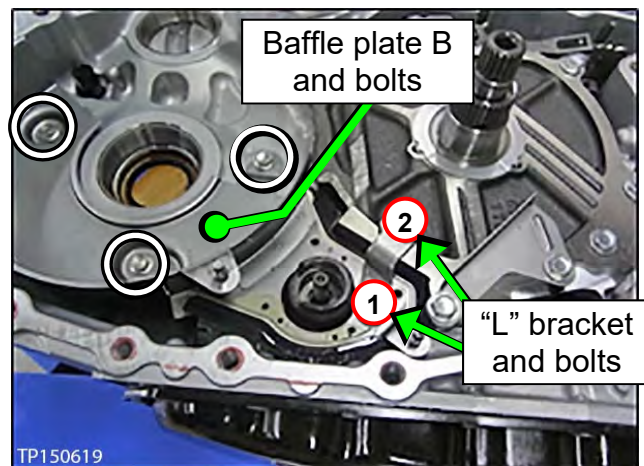

Figure 127

103. Install the thrust washer onto the dummy over (Figure 128).
- Use petroleum jelly or equivalent to hold the thrust washer in place.
 - Make sure the tabs fit into the holes.

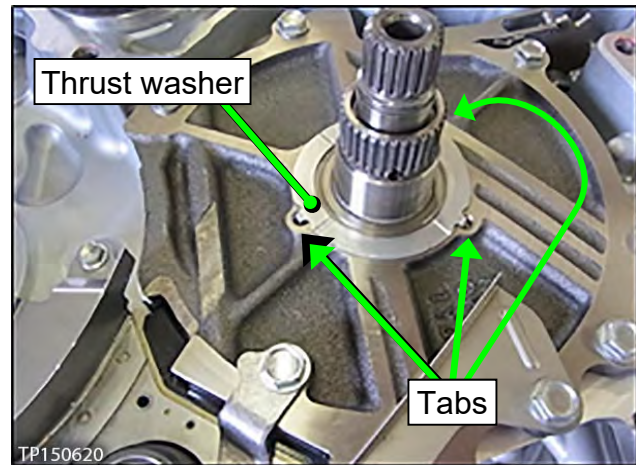

Figure 128

104. Install the drive sprocket, driven sprocket, and chain as an assembly (Figure 129).

- Make sure the raised edge (wider edge) on the drive sprocket is facing up (Figure 130).

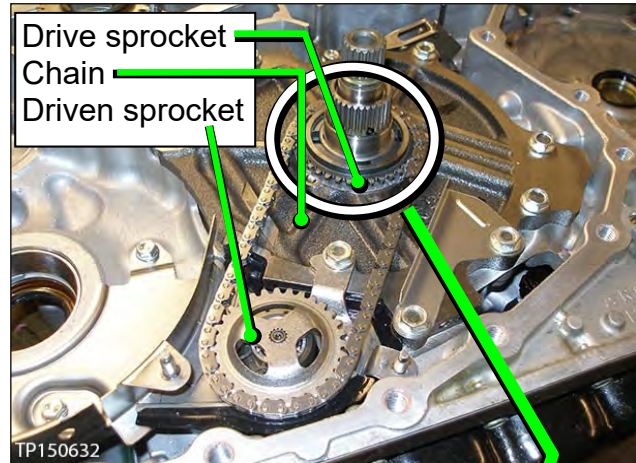

Figure 129

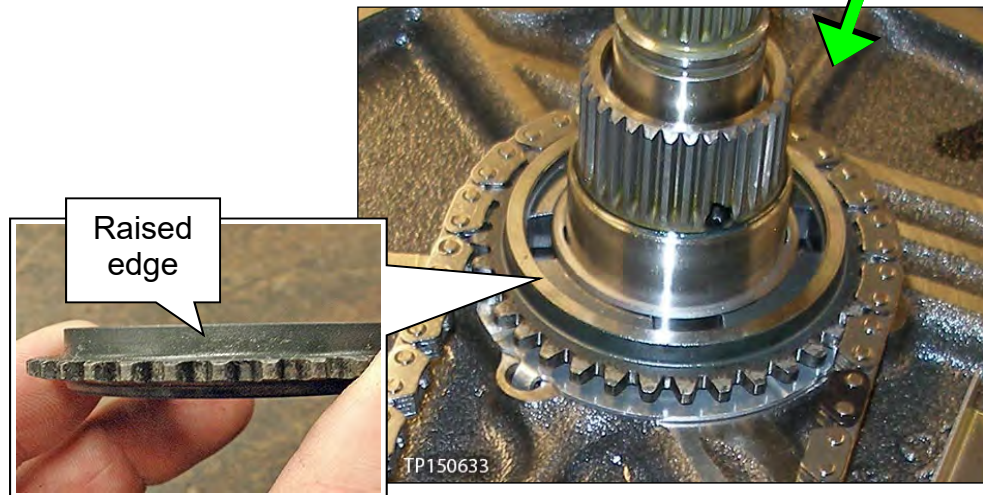

Figure 130

- Expand the snap ring with a suitable tool, and then push down on the driven sprocket until it bottoms out (Figure 131).
- Release the snap ring and then pull up on the driven sprocket until the snap ring locks into its groove.

NOTE: A click sound is heard when the snap ring locks in place.

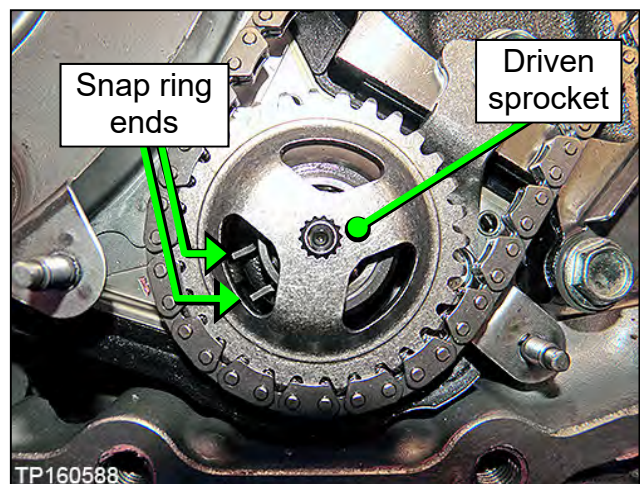

Figure 131

105. Install baffle plate A with two nuts (Figure 132).

- Nut torque: 5.9 N•m (0.6 kg-m, **52.2 in-lb.**)

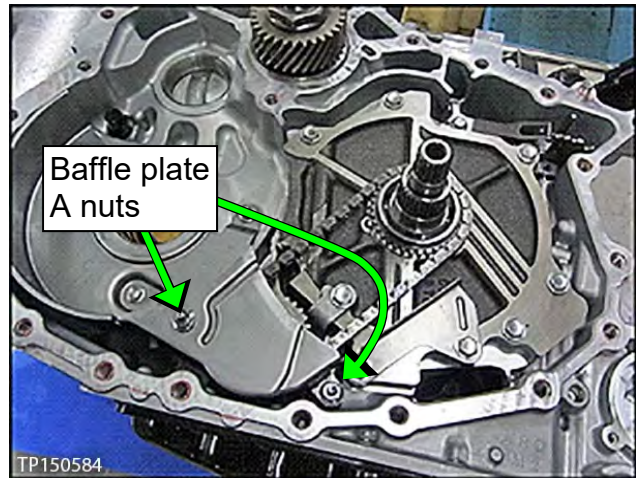

Figure 132

106. Install a new O-ring on the input shaft (Figure 133).

- Apply CVT fluid to the O-ring and O-ring groove before installing.

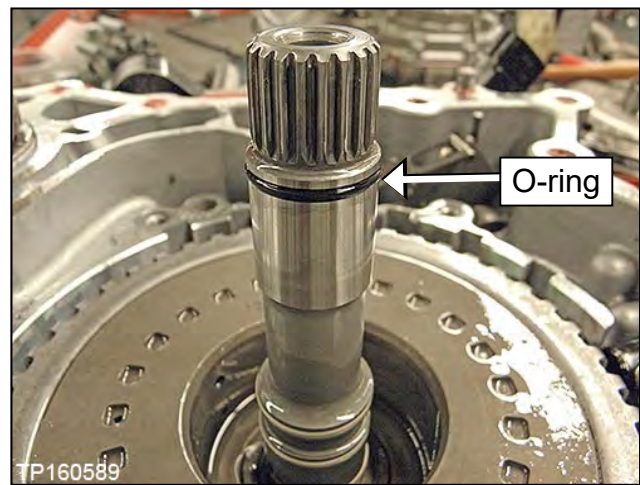

Figure 133

107. Install the differential assembly and the reduction gear assembly into the CVT case (Figure 134).

- Thoroughly clean each assembly before installing.
- Oil the bearings and gear teeth with CVT fluid before installing.

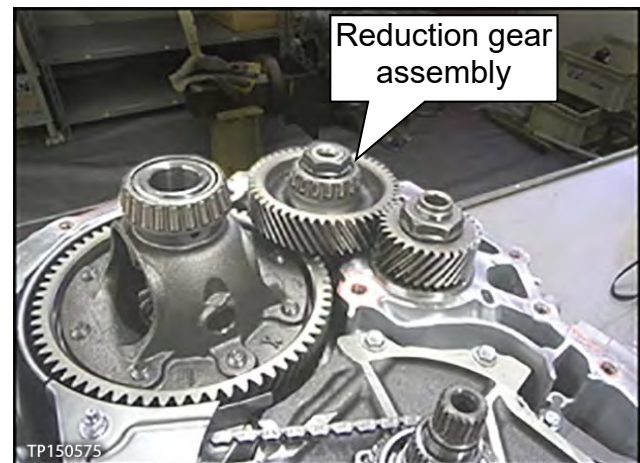
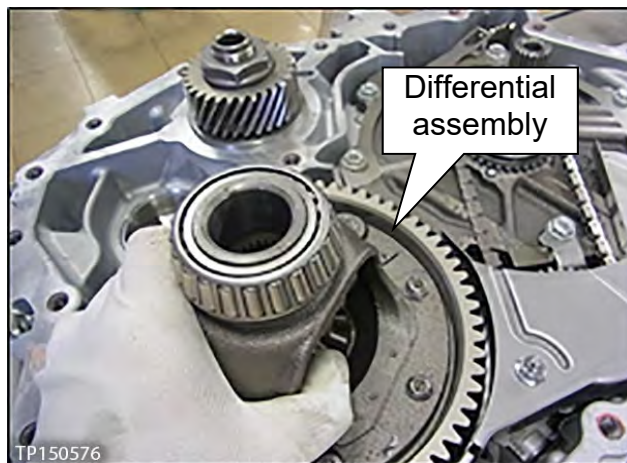

Figure 134

108. Install the CVT fluid filter and components (Figure 135).

- Install a new filter with grommet (one part).
- Install a new O-ring.
- Confirm that all components and areas where components fit are thoroughly clean.
- Apply CVT fluid to the grommet seal and O-ring before installing.
- Install the filter cover.
 - Bolt torque 4.2 N•m (0.43 kg-m, 37.2 in-lb.)

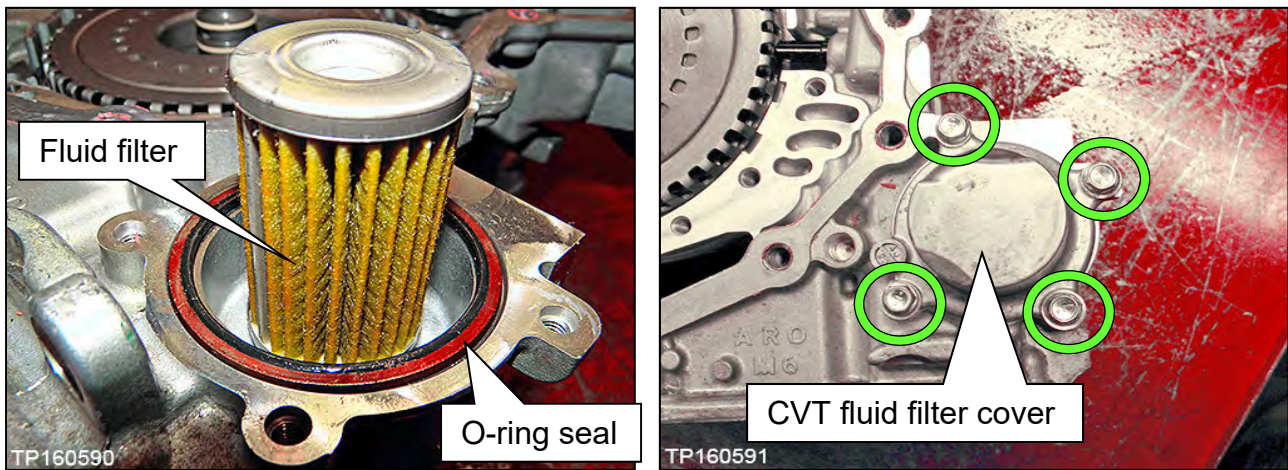

Figure 135

109. Confirm the pin (Figure 136) is located in the CVT case prior to installation of the converter housing.

NOTE: Apply petroleum jelly or equivalent to keep it in place if necessary.

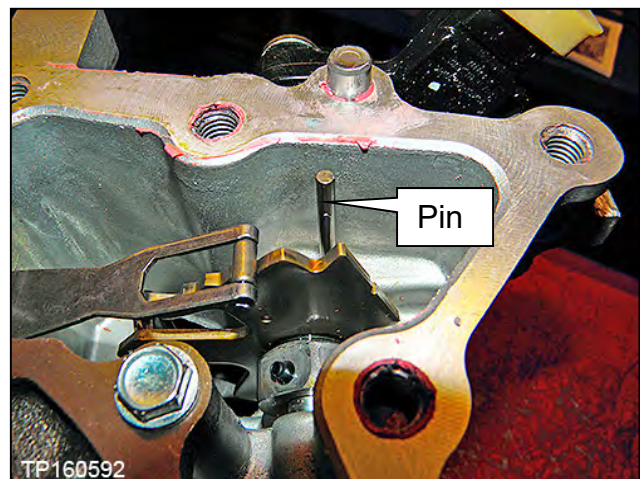

Figure 136

110. Apply one continuous 2.0 mm (**0.8 inches**) diameter bead (Figure 137) of pink colored Loctite 5460 Sealant (see the Parts Information section of this bulletin).

- Before sealant application, make sure the mating surfaces are clean from oil, dirt, old sealant, etc. (Figure 137).

IMPORTANT: Have the converter housing ready for installation prior to applying the sealant.

NOTE:

- Start applying sealant where shown, making sure that the starting point and the ending point are about the middle between the bolt holes.
- Overlap both ends of the bead by 3-5 mm (**0.12-0.20 inches**).
- Make sure to apply sealant around the center bolt hole.

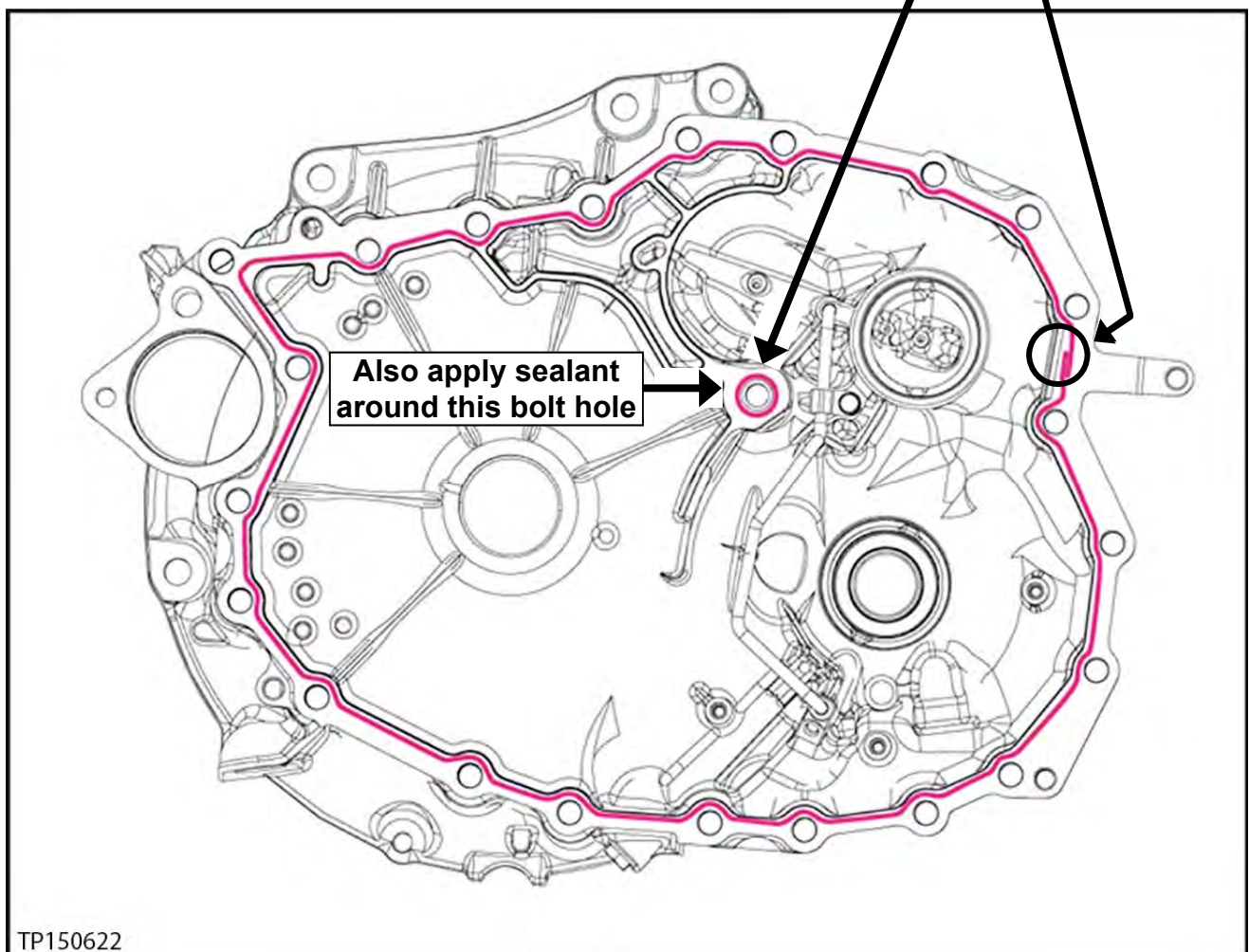





Figure 137

111. Install the converter housing onto the CVT case (see Figure 138 for torque sequence):

- Install new bolts (23).
 - a. Torque the first six (6) bolts with symbol  in numbered sequence (see below).
 - b. Torque the remaining bolts with symbol  in numbered sequence (see below).
- Use a short socket on the bolts indicated by this symbol: 
 - All bolts are 30 mm (1.2 inches) in length.
 - Bolts torque: 45.0 N•m (4.6 kg-m, 33.2 ft-lb.)

IMPORTANT: Make sure to torque the bolts in the sequence shown (Figure 138).

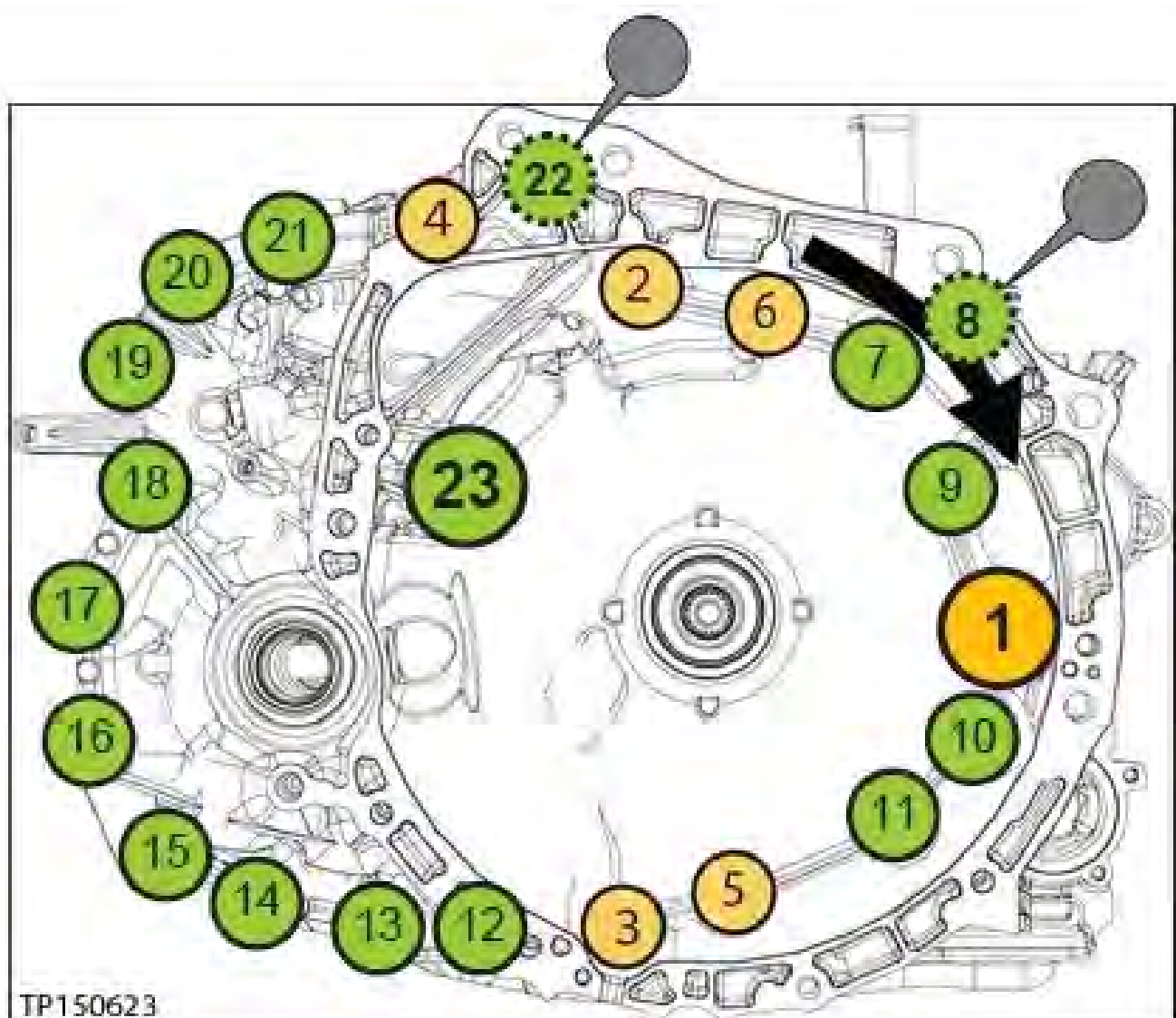

Figure 138

112. Clean off the excess sealant.

Control Valve (Valve Body) Strainer and Pan Installation

IMPORTANT:

- Installation steps in this bulletin may contain different style parts than what were originally installed in the CVT. Pay careful attention, REASSEMBLY MAY NOT BE IDENTICAL TO DISASSEMBLY.
- **Confirm that the QR label, control valve and CD part numbers all match before installing the control valve** (refer to NTB12-103).
- For additional information, see video # 547: “CVT Belt and Pulley Replacement” and fast forward to minute marker 20:09. This video is located under the TECH TRAINING GARAGE VIDEOS tab in Virtual Academy.

CAUTION: Handle the valve body carefully.

NOTE: If an oil strainer bracket was removed, discard it. An oil strainer bracket (Figure 139) will not be used with the new oil strainer.



Figure 139

113. Install a new lip seal (Figure 140).

- Do **NOT** reuse the old lip seal.
- Apply a small amount of petroleum jelly or equivalent to the lip seal to keep it in place on the CVT.

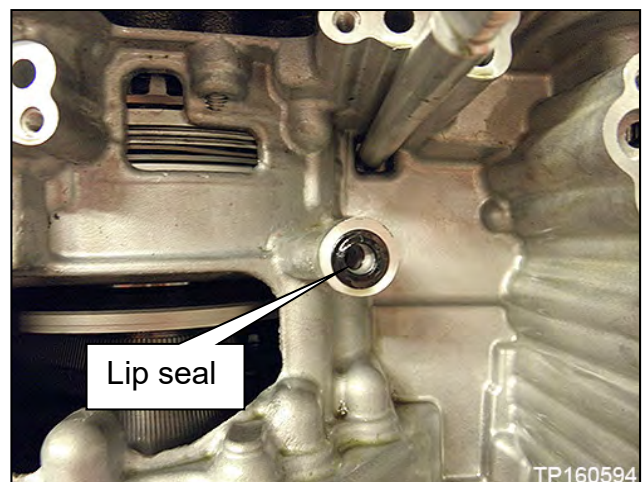





Figure 140

114. Install the Control Valve with eleven (11) mounting bolts (Figure 141).

IMPORTANT: Leave four (4)  bolt holes blank at this step.

CAUTION: Make sure the wiring harness does not get pinched (see Figure 142 and Figure 143 for correct routing).

- 54 mm (2.125 inches) long bolt  ; 7 pieces
- 44 mm (1.73 inch) long bolt  ; 2 pieces
- 25 mm (1 inch) long bolt  ; 2 pieces

CAUTION: The two 25 mm bolts are installed WITHOUT the strainer bracket.

➤ Bolt torque: 7.9 N•m (0.81 kg-m, 70 in-lb.)

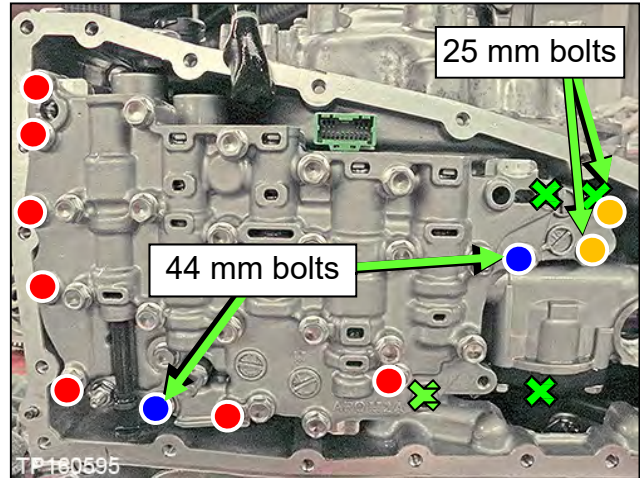

Figure 141

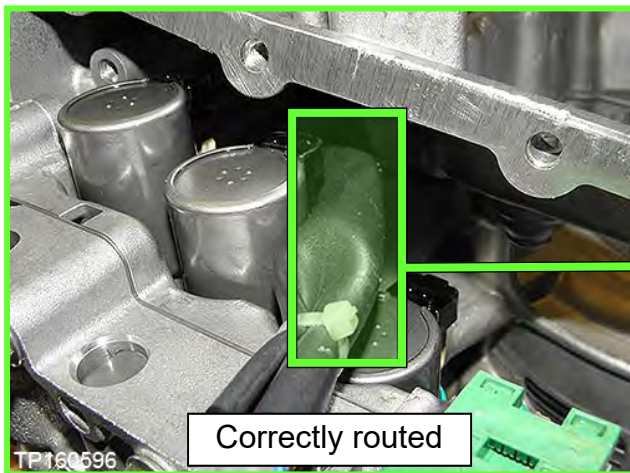

Figure 142

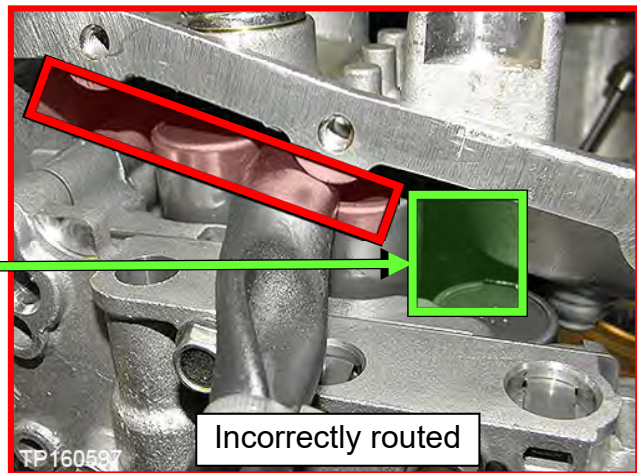

Figure 143

115. Replace the metal bracket of the fluid temperature sensor as follows:

NOTE: The new bracket will be oriented the same way the old bracket was.

- a. Cut the old plastic zip tie with an appropriate tool to remove the fluid temperature sensor's metal bracket from the terminal harness assembly (Figure 145 and Figure 144).

CAUTION: Cut the plastic zip tie over the metal bracket to avoid damage to the fluid temperature sensor.

- b. Discard the removed metal bracket and plastic zip tie.
- c. Use the new plastic zip tie from the Parts Information to attach the fluid temperature sensor of the terminal connector harness to the fluid temperature sensor's new metal bracket.

IMPORTANT:

- Locate the plastic zip tie at the center notch of three notches on the fluid temperature sensor (Figure 144).
 - Tighten the plastic zip tie so that it is oriented as shown in Figure 145.
- d. Cut off the plastic zip tie excess.

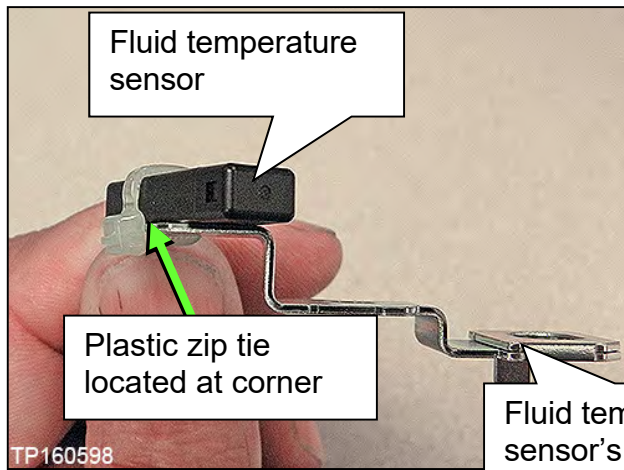

Figure 144

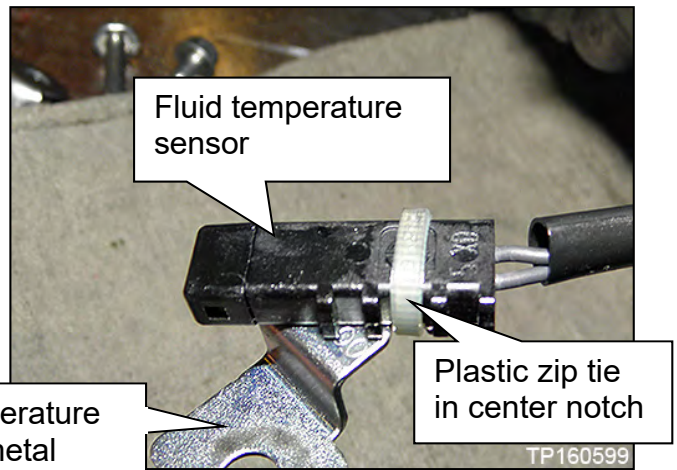

Figure 145

116. Connect the electrical harness connector (Figure 146).

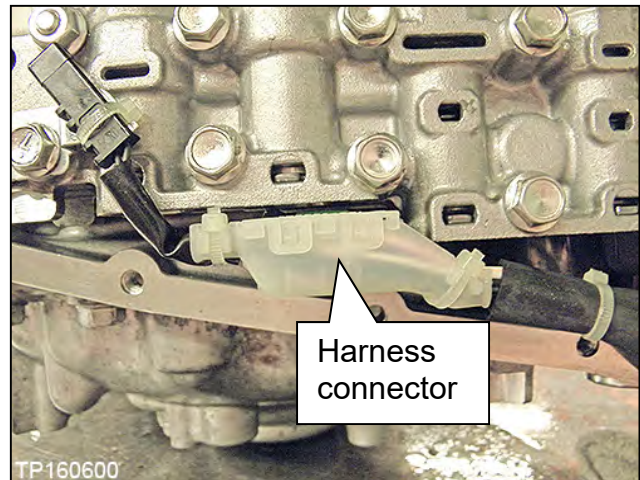

Figure 146

117. Install the CVT fluid temperature sensor bracket to the valve body with one (1) bolt (Figure 147).

NOTE: Leave one (1) bolt hole blank as it will be used to secure the oil strainer at a later step.

- 54 mm (**2.125 inches**) long bolt.
 - Bolt torque: 7.9 N•m (0.81 kg-m, **70 in-lb.**)

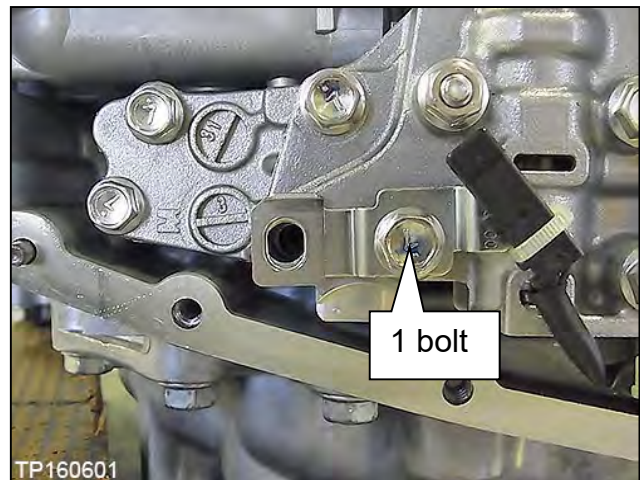



Figure 147

118. Install the new oil strainer with its new O-ring seal with two (2) bolts (Figure 148).

NOTE: Replacement strainer maybe a different shape than the original.

- 54 mm (**2.125 inches**) long bolt  ; 2 pieces.
 - Bolt torque: 7.9 N•m (0.81 kg-m, **70 in-lb.**)

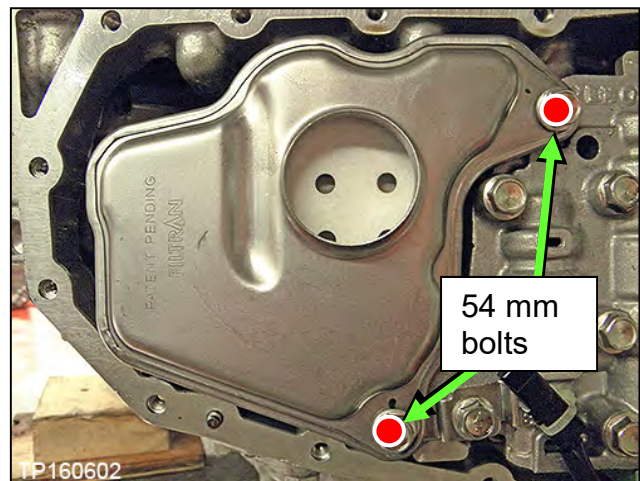

Figure 148

119. Install the manual plate, lock washer, and nut (Figure 149).

NOTE: Make sure the manual plate fits into the slot of the manual valve before applying torque to the nut.

- Reuse the existing manual plate, lock washer, and nut.
 - Nut torque: 22.1 N•m (2.3 kg-m, **16 ft-lb.**)

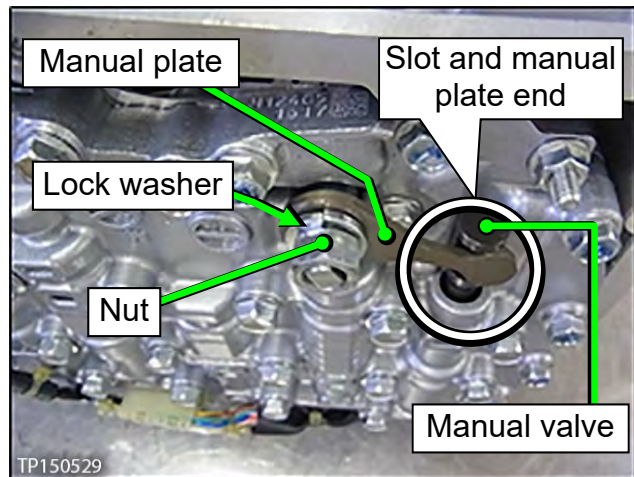

Figure 149

120. Clean the original oil pan and magnets with a suitable cleaner. Visible debris should not be present at re-assembly.

121. Reassemble the original magnets to the pan.

NOTE: Return the magnets to their original locations.

122. Install a new oil pan gasket to the pan.

123. Install the oil pan bolts (see Figure 150).

- Reuse the existing oil pan bolts.
 - Oil pan bolts torque: 7.9 N•m (0.81 kg-m, **70 in-lb.**)

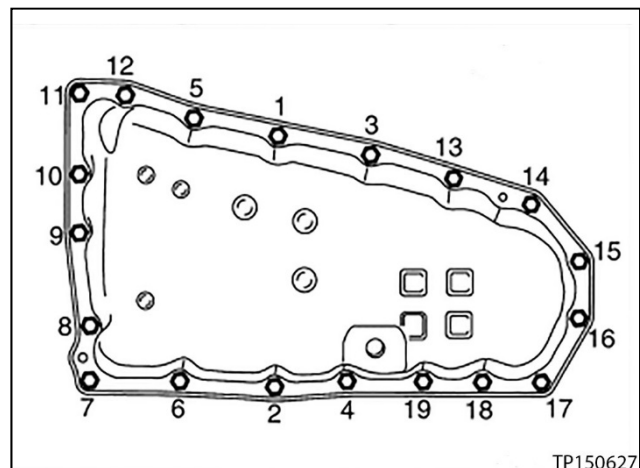

Figure 150

124. Install a new drain washer to the drain plug on the oil pan.

125. Install the primary speed sensor to the CVT assembly.

IMPORTANT: Install a new O-ring to the speed sensor before installation. DO NOT reuse the old O-ring.

- Bolt torque: 5.9 N•m (0.6 kg-m, **52 in-lb.**)

126. Install the torque converter to the CVT assembly.

- Verify the torque converter is installed at the proper depth (see Figure 151).
- \textcircled{A} = 14.4 mm

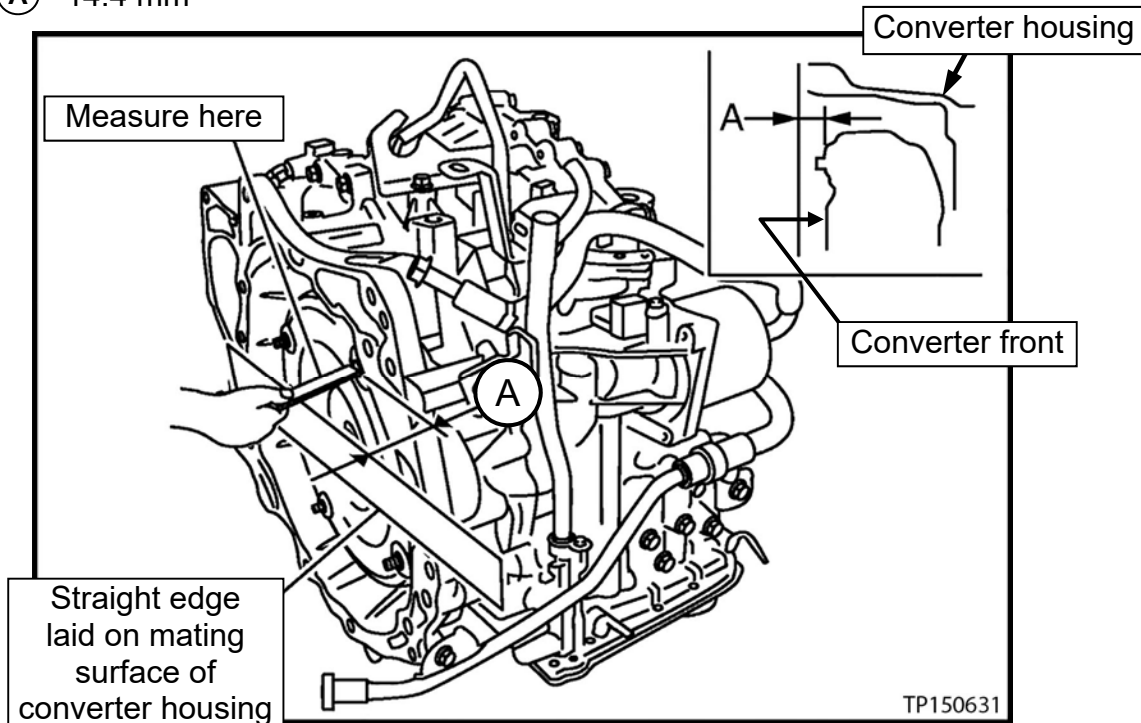

Figure 151

127. Attach the QR label (Figure 153) with the new calibration data onto the transmission range switch (inhibitor switch Figure 152).

- A QR Label and CD-R are included with the new valve body.
- Confirm that the QR label and the CD-R part numbers are the same (Figure 153).

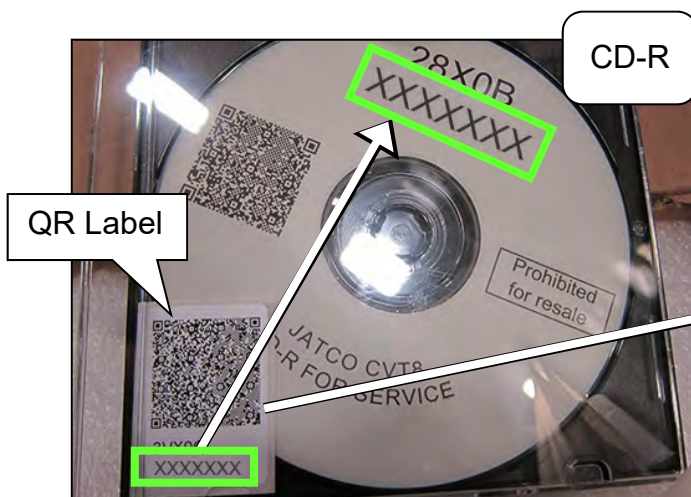

Figure 152

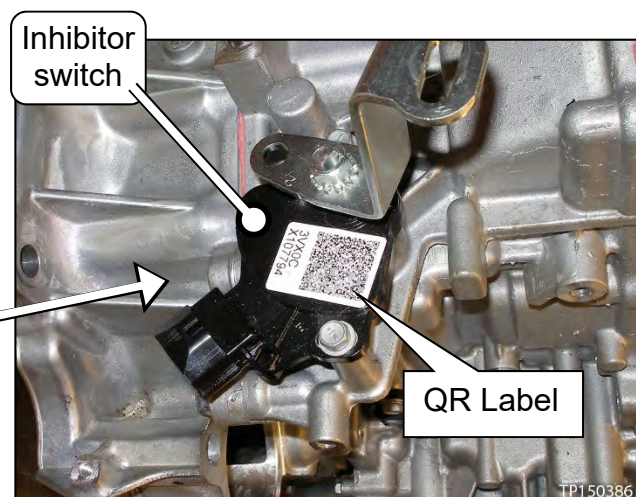

Figure 153

Install the CVT Assembly

128. Install the CVT assembly into the vehicle.

NOTE: Refer to the ESM, section **Transaxle & Transmission**, for CVT installation.

And then,

- 2WD vehicles skip to step 129 below.
- Vehicles with all-wheel drive, install the transfer case as follows:
 - a. Replace only the external O-ring to the transfer case and then install the transfer case to the CVT.
 - Apply CVT fluid to the O-ring.

NOTE:

- Refer to the ESM, section **Driveline**, for the transfer assembly installation.
- Use extreme caution when installing the axle to the transfer case assembly to avoid seal damage or deformation.
- Properly support and guide the axle.

b. Proceed to step 129.

129. Flush the CVT cooler.

IMPORTANT: A CVT Cooler flush is required. Refer to bulletin NTB15-013 to perform CVT Cooler flush.

130. Connect both battery cables, negative cable last.

131. Reset/reinitialize systems as needed.

- Refer to the ESM, section **Power Supply & Ground Elements**, for a listing of systems that require reset/initialization after reconnecting the 12V battery.
- Look for **ADDITIONAL SERVICE WHEN REMOVING BATTERY NEGATIVE TERMINAL**.
- This list often includes items such as radio, power windows, clock, sunroof, etc.

132. Refer to step 138 on page 79 and confirm if a TCM reprogram is available for the vehicle you are working on.

Is a reprogram available?

- **YES:** Perform **TCM reprogramming** starting on page 78.
- **NO:** Proceed to step 148 on page 85.

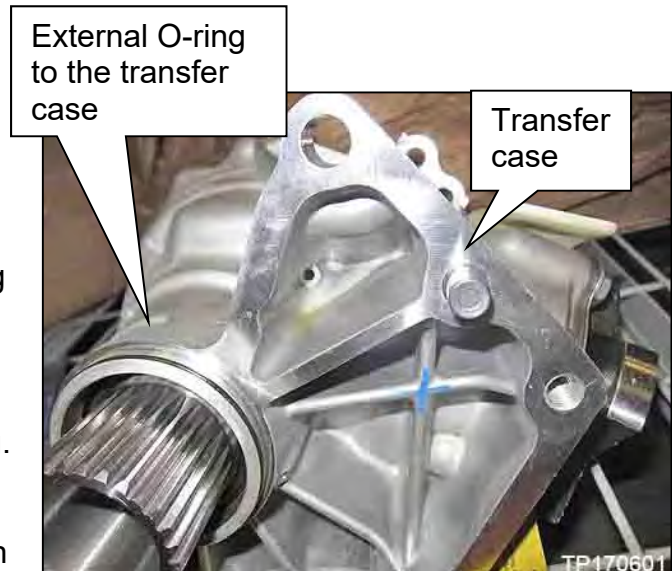

Figure 154

TCM Reprogramming

IMPORTANT: Before starting, make sure:

- ASIST on the CONSULT PC has been synchronized (updated) to the current date.
- All CONSULT-III plus (C-III plus) software updates (if any) have been installed.

NOTE:

- Most instructions for reprogramming with C-III plus are displayed on the CONSULT PC screen.
- If you are not familiar with the reprogramming procedure, [click here](#). This will link you to the "CONSULT- III plus (C-III plus) Reprogramming" general procedure.

CAUTION:

- Connect the GR8 to the vehicle battery, set to "power supply" mode. If the vehicle battery voltage drops below 12.0V or rises above 15.5V during reprogramming, the TCM may be damaged.
- Be sure to turn OFF all vehicle electrical loads. If a vehicle electrical load remains ON, the TCM may be damaged.
- Be sure to connect the AC Adapter. If the CONSULT PC battery voltage drops during reprogramming, the process will be interrupted and the TCM may be damaged.
- Turn OFF all external Bluetooth® devices (e.g., cell phones, printers, etc.) within range of the CONSULT PC and the VI. If Bluetooth® signal waves are within range of the CONSULT PC during reprogramming, reprogramming may be interrupted and the TCM may be damaged.

133. Connect the CONSULT PC to the vehicle to begin the reprogramming procedure.

134. Start C-III plus.

135. Wait for the plus VI to be recognized.

- The serial number will display when the plus VI is recognized.

136. Select **Re/programming, Configuration**.

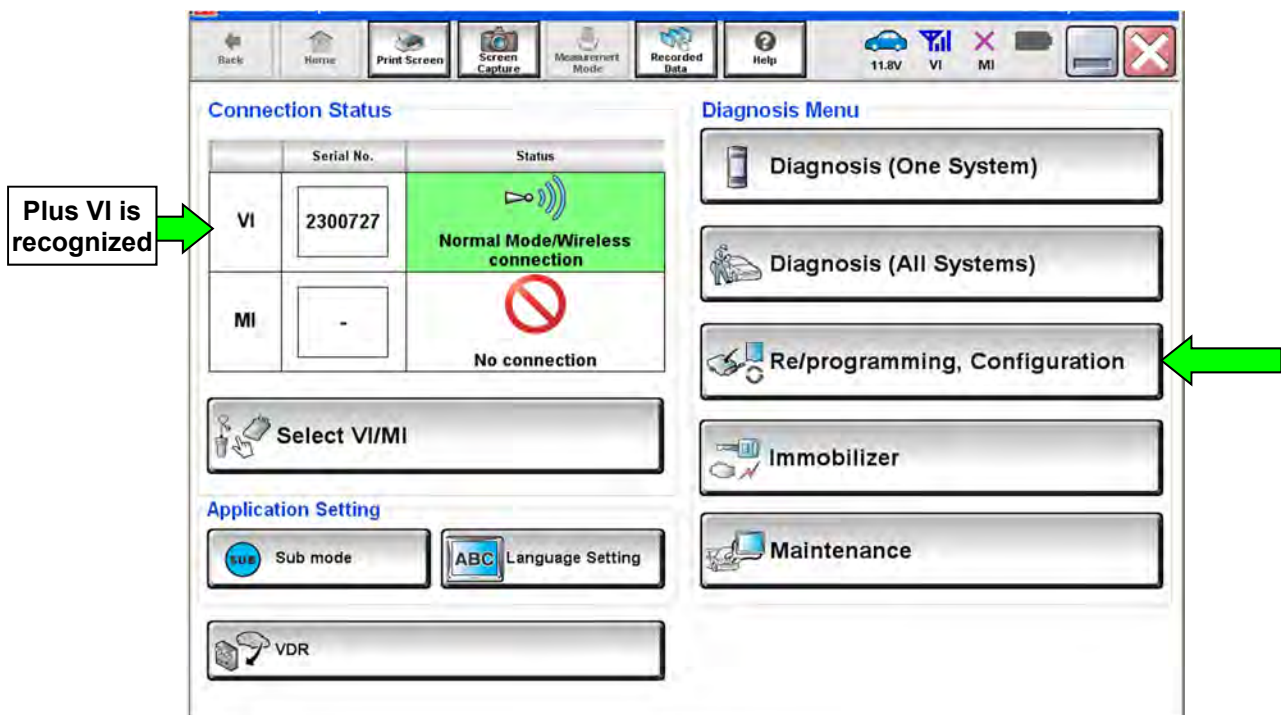

Figure 155

137. Follow the on-screen instructions and navigate the C-III plus to the screen shown in Figure 156 on the next page.

138. When you get to the screen shown in Figure 156, confirm reprogramming applies as follows.

A. Find the TCM **Part Number** and write it on the repair order.

NOTE: This is the current TCM Part Number (P/N).

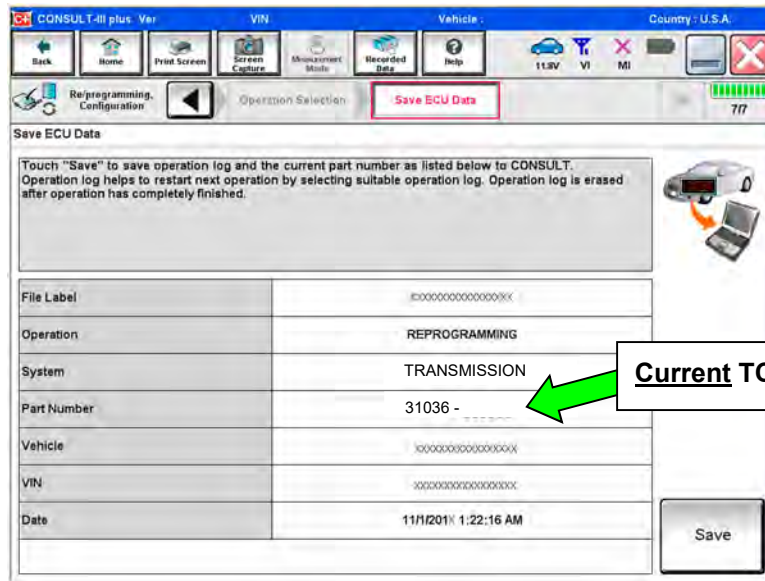

Figure 156

B. Compare the P/N you wrote down to the numbers in the **Current TCM Part Number** column in **Table B** below.

- If there is a match, continue with the reprogramming procedure; step 139.
- If there is not a match, reprogramming is not needed; continue to step 148, **Perform ADDITIOANL SERVICE WHEN REPLACING CONTROL VALVE.**

Table B

MODEL	MODEL YEAR	CURRENT TCM PART NUMBER BEFORE REPROGRAMMING: 31036 -
Altima (4-cyl engine only)	2013	3TA0A 3TA4A, 3TA4B, 3TA4C 3TA9C 3TY0A, 3TY0B, 3TY0C, 3TY0D, 3TY0E 3TY1A, 3TY1B, 3TY1C, 3TY1D, 3TY1E
	2014-2015	9HM0A, 9HM0C, 9HM0D, 9HM0E 9HM3A, 9HM3B, 9HM3C
	2016	3TE0C, 3TE0D, 3TE2C, 3TE2D 3TH0A, 3TH0B, 3TH2A, 3TH2B
	2017	9HS4A, 9HS6A
Rogue	2014	4BA0A, 4BA0B, 4BA5A, 4BA5B, 4BA8A 4BA9A, 4BA9B, 4BA9C, 4BA9D
	2015	5HA0A, 5HA0B, 5HA0C 5HA5A, 5HA9A 9TA0A, 9TA0B, 9TA0C, 9TA0D 9TA5A, 9TA9A
	2016	5HJ0A, 5HJ0B, 5HJ0C, 5HJ0D 5HJ9A, 6FJ0A, 6FJ0B, 6FJ0C, 6FJ0D, 6FJ9A, 6FK0A
	2017	5HK0A, 5HK0B, 5HK1A, 5HK1B 6FL0A, 6FL0B, 6FL1A, 6FL1B

139. Follow the on-screen instructions to navigate C-III plus and reprogram the ECM.

NOTE:

- In some cases, more than one new P/N for reprogramming is available.
 - If more than one new P/N is available, the screen in Figure 157 displays.
 - Select and use the reprogramming option that does **not** have the message “Caution! Use ONLY with NTBXX-XXX”.
- If you get this screen and it is blank (no reprogramming listed), it means there is no reprogramming available for this vehicle. Close C-III plus and refer back to ASIST for further diagnosis.

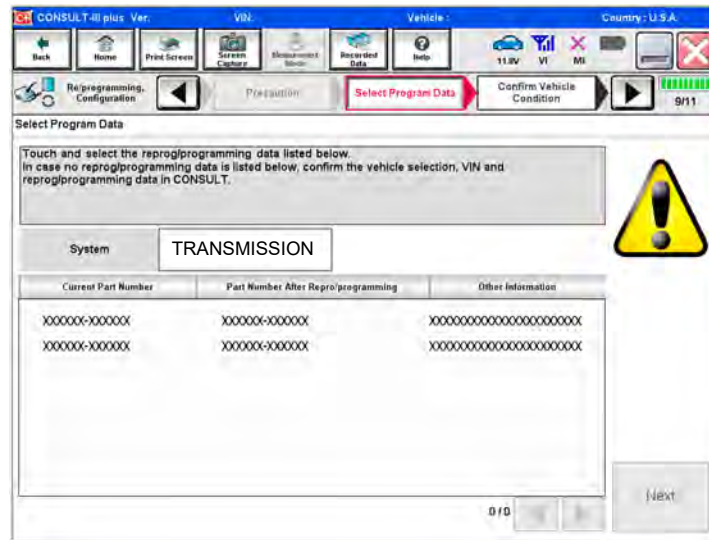

Figure 157

- Before reprogramming will start, you will be required to enter your User Name and Password.
 - The CONSULT PC must be connected to the Internet (Wi-Fi or cable).
 - If you do not know your User Name and Password, contact your Service Manager.

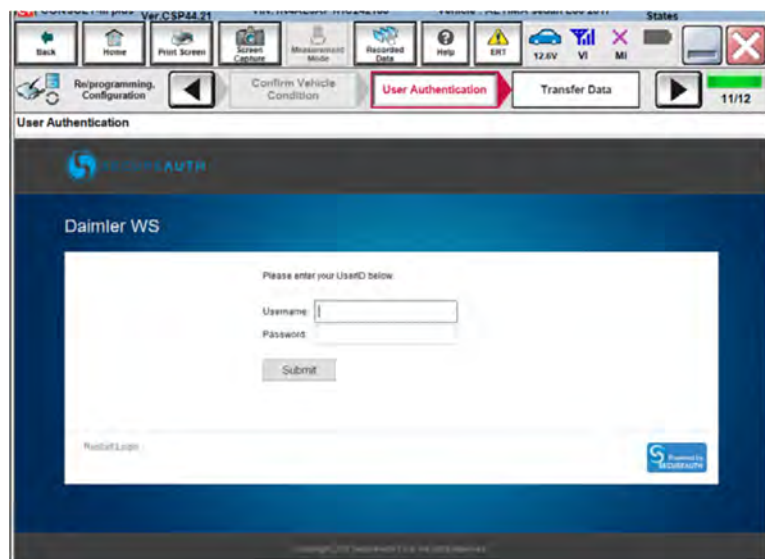

Figure 158

140. When the screen in Figure 159 displays, reprogramming is complete.

NOTE: If the screen in Figure 159 does not display (indicating that reprogramming did not complete), refer to the information on the next page.

141. Disconnect the battery charger from the vehicle.

142. Select **Next**.

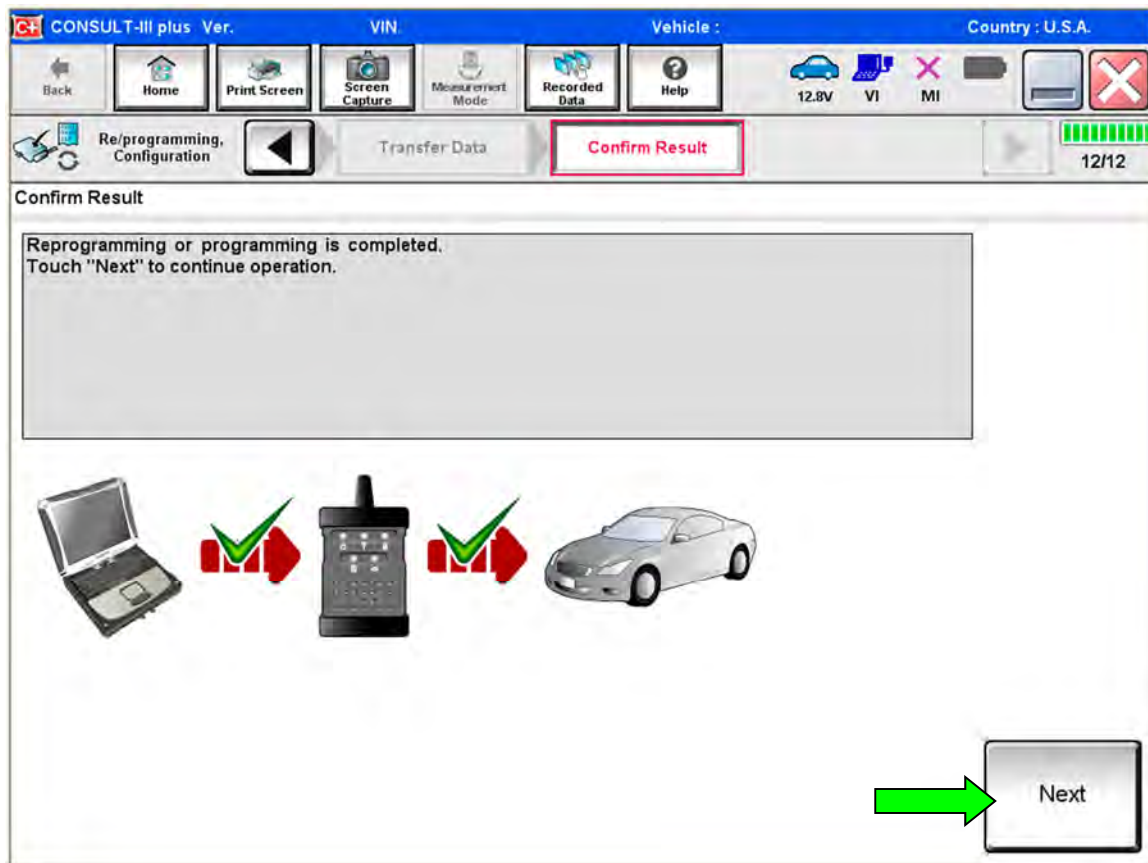

Figure 159

NOTE:

- In the next step (page 84) you will perform **Erase All DTCs**.
- DTC erase is required before C-III plus will provide the final reprogramming confirmation report.

TCM Recovery:

Do not disconnect plus VI or shut down C-III plus if reprogramming does not complete.

If reprogramming does not complete and the “!?” icon displays as shown in Figure 160:

- Check battery voltage (12.0–15.5 V).
- Ignition is ON, engine OFF.
- External Bluetooth® devices are OFF.
- All electrical loads are OFF.
- **Select retry and follow the on screen instructions.**
- **“Retry” may not go through on first attempt and can be selected more than once.**

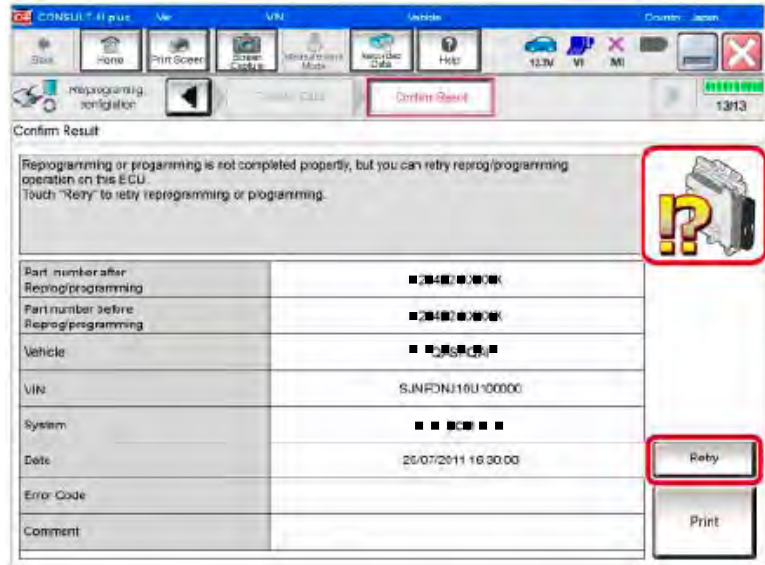

Figure 160

If reprogramming does not complete and the “X” icon displays as shown in Figure 161:

- Check battery voltage (12.0 – 15.5 V).
- CONSULT A/C adapter is plugged in.
- Ignition is ON, engine OFF.
- Transmission is in Park.
- All C-III plus / VI cables are securely connected.
- All C-III plus updates are installed.
- **Select Home, and restart the reprogram procedure from the beginning.**

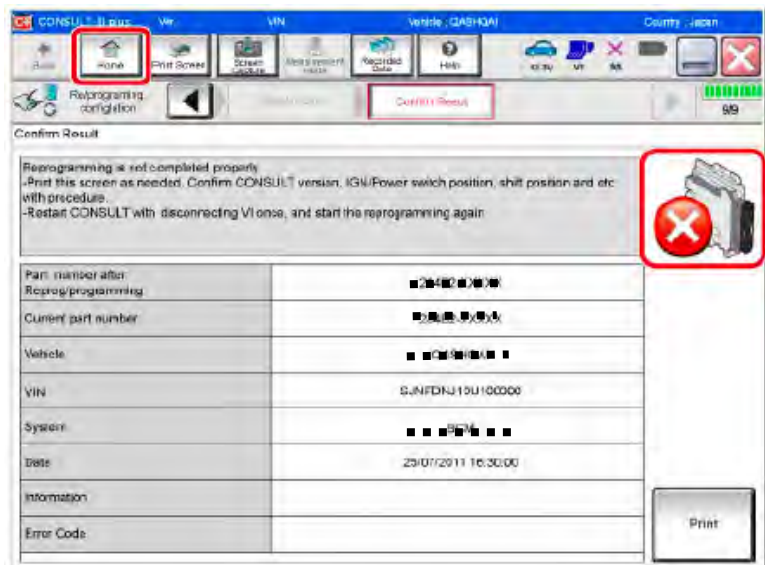

Figure 161

- 143. Follow the on-screen instructions to **Erase All DTCs**.
- 144. When the entire reprogramming process is complete, the screen in Figure 162 will display.
- 145. Verify the before and after part numbers are different.
- 146. Print a copy of this screen (Figure 162) and attach it to the repair order for warranty documentation.
- 147. Select **Confirm**.

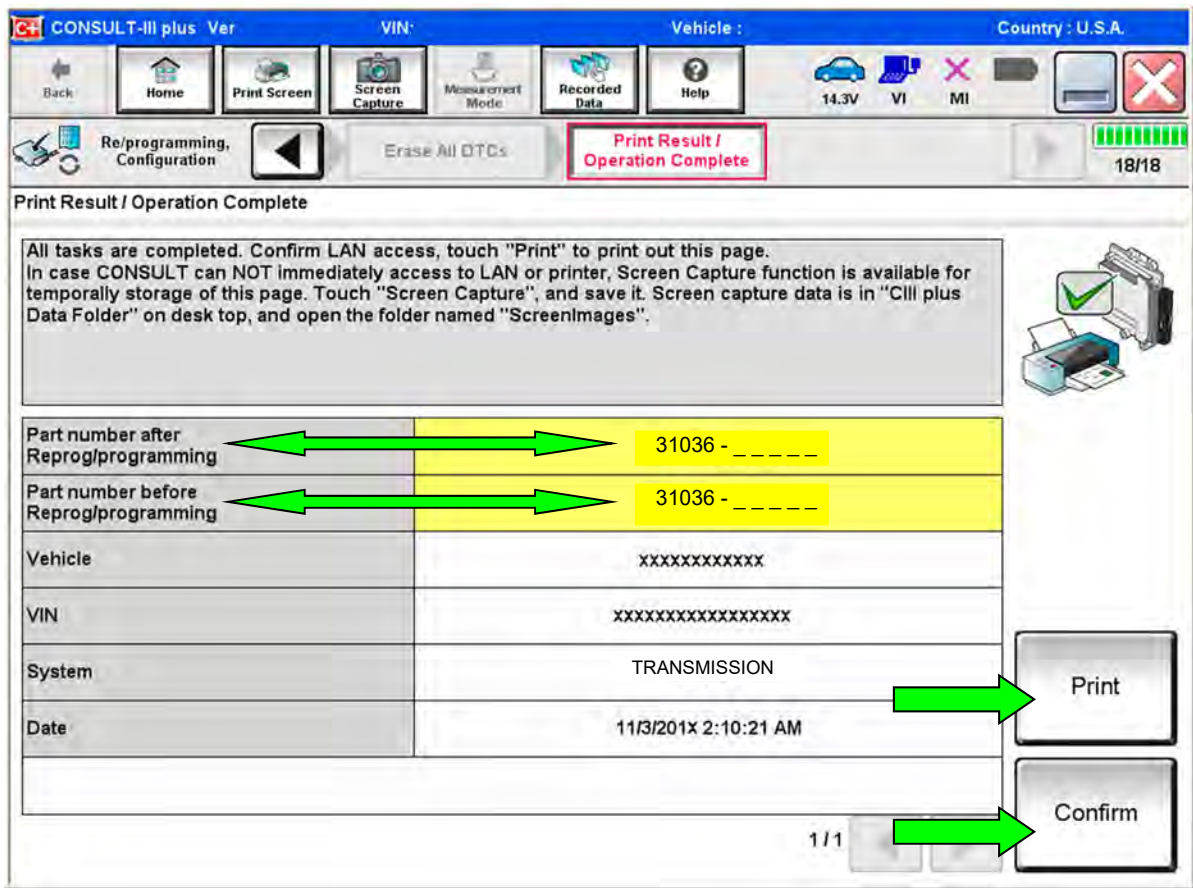

Figure 162

148. Perform **ADDITIONAL SERVICE WHEN REPLACING CONTROL VALVE.**

- Refer to **Transaxle & Transmission / RE0F10E / BASIC INSPECTION**, and perform **ADDITIONAL SERVICE WHEN REPLACING CONTROL VALVE.**

NOTE: Use the procedure starting on page 86 for **FWD CLUTCH POINT LEARNING.**

- Use the check-off table below and check off each Additional Service Procedure as they are performed.

IMPORTANT: Check off these additional services as they are completed and attach this to the repair order when finished.

CHECK OFF	ADDITIONAL SERVICE PROCEDURE
	PRINT CURRENT CALIBRATION DATA
	CHECK THE SERIAL NUMBER
	WRITE THE DATA (WRITE IP CHARA)
	PRINT NEW CALIBRATION DATA
	FWD CLUTCH POINT LEARNING (If needed, TCM reprogramming must be done first. Use procedure starting on page 86.)
	PERFORM SELECT LEARNING (DRIVE/REVERSE LEARNING on page 89)
	ERASE CVT FLUID DEGRADATION LEVEL DATA

149. Return C-III plus to the Home screen.

150. Turn OFF C-III plus and the vehicle ignition.

151. Disconnect C-III plus from the vehicle.

152. Test drive the vehicle:

- Make sure the MIL is OFF.
- This bulletin does not cover any DTC repairs other than those listed on page 2 in the Flow Chart.
- If the MIL comes ON, go to ASIST for further diagnostic information.
- Verify the CVT operates normally and no abnormal noises are heard during a test drive.

FWD CLUTCH POINT LEARNING (using CONSULT-III plus)

NOTE: If a TCM update is available (see page 79), the TCM MUST be reprogrammed before performing FWD CLUTCH POINT LEARNING.

153. Apply the vehicle's parking brake.
154. Start the engine and warm up to operating temperature (50-100° C [122-212° F]).
155. Connect the CONSULT PC to the vehicle.
156. Start C-III plus.
157. Wait for the plus VI to be recognized.
 - The serial number will display when the plus VI is recognized.
158. Select **Diagnosis (One System)**.

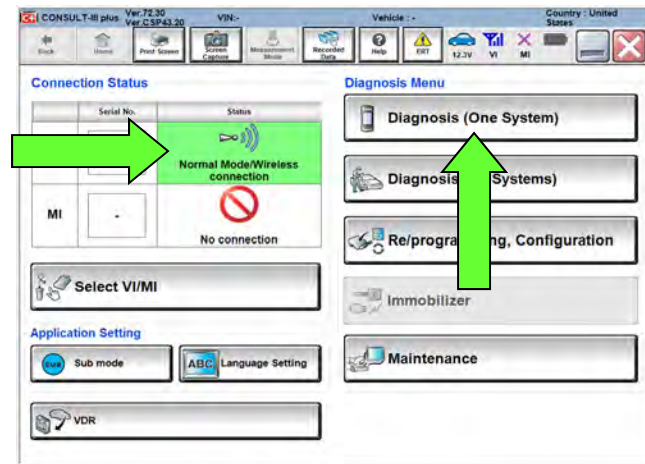

Figure 163

159. Select **Work Support** under TRANSMISSION.

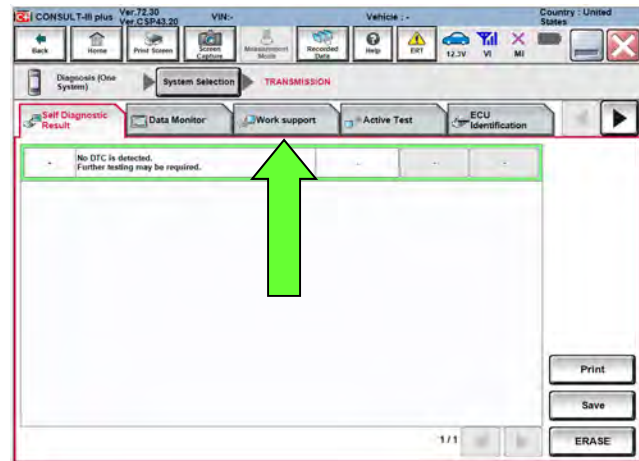

Figure 164

IMPORTANT: The following **FWD CLUTCH POINT LEARNING** will be performed twice; once in drive (D) and once in reverse (R).

160. Select **FWD CLUTCH POINT LEARNING** and then **Start**.

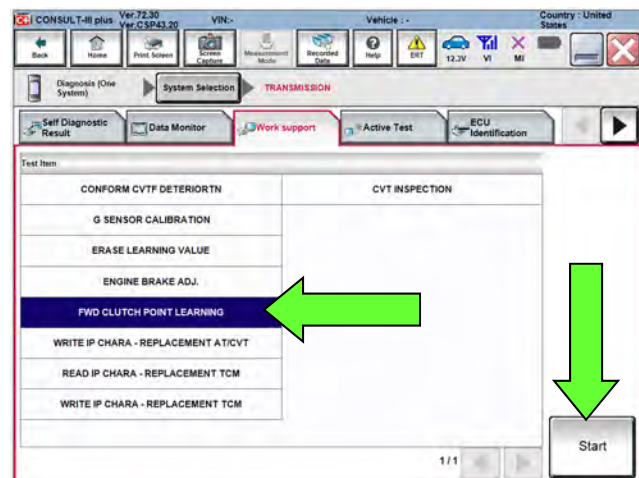

Figure 165

161. With the engine still running and at idle, depress the brake pedal and shift the CVT into neutral (N).

- Confirm that all of the required conditions indicated in Figure 166 are being met.

162. Select **Start**.

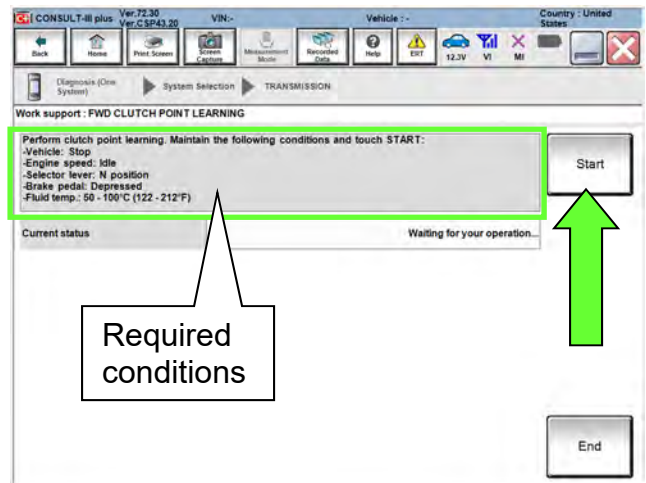

Figure 166

163. While maintaining all conditions shown in Figure 166 and the “Current status” indicates “EXECUTING”, shift the CVT into **D** and then wait until the Current status indicates “COMPLETED”.

NOTE: This may take up to three (3) minutes to complete.

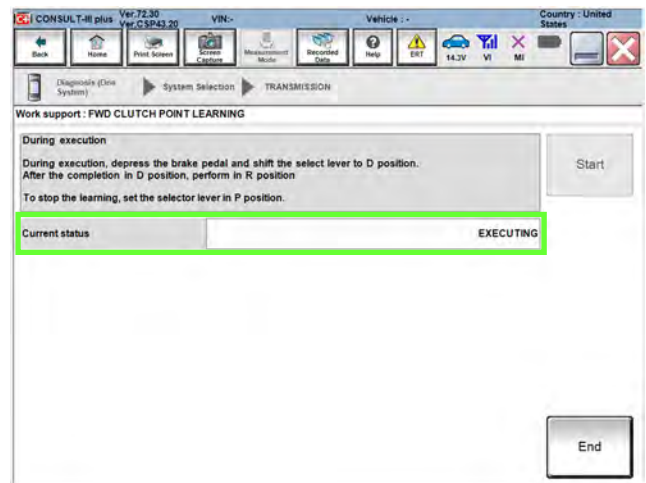

Figure 167

164. When the screen in Figure 168 is displayed, shift the CVT into **P**, and then select **End**.

165. Turn the engine OFF and then back ON.

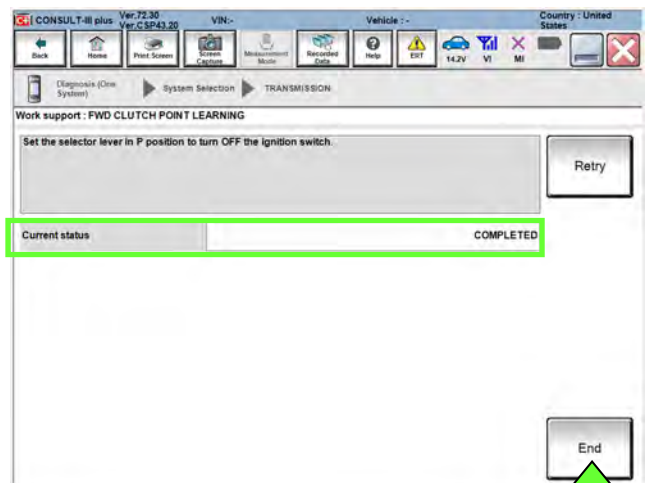

Figure 168

166. Select **FWD CLUTCH POINT LEARNING** and then **Start**.

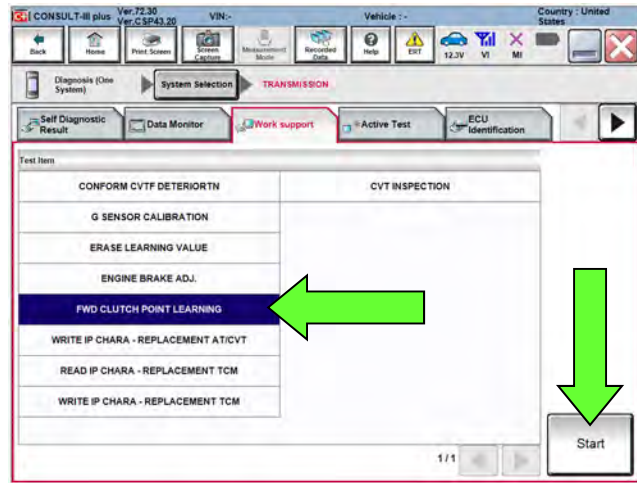

Figure 169

167. With the engine still running and at idle, depress the brake pedal and shift the CVT into neutral (**N**).

- Confirm that all of the conditions indicated in Figure 170 are being met.

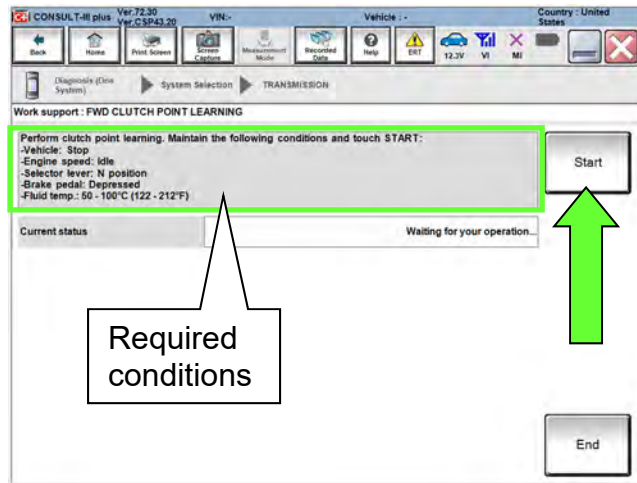

Figure 170

168. Select **Start**.

169. While maintaining all conditions shown in Figure 170 and the Current status indicates EXECUTING, shift the CVT into **R** and then wait until the Current status indicates COMPLETED.

NOTE: This may take up to 3 minutes to complete.

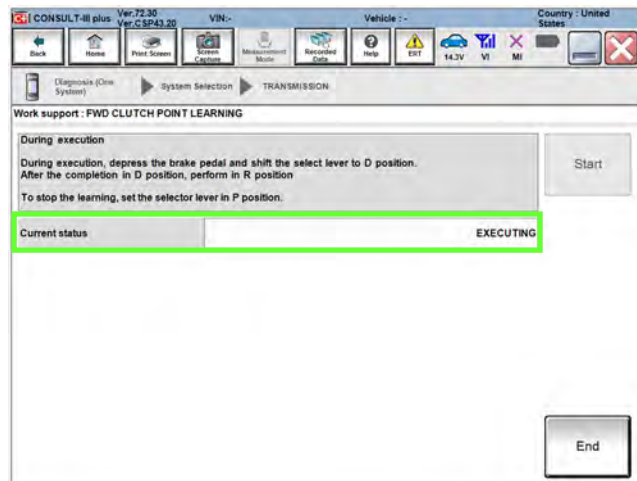

Figure 171

170. When the screen in Figure 172 is displayed select **End**, shift the CVT into **P**, and then turn the engine OFF.

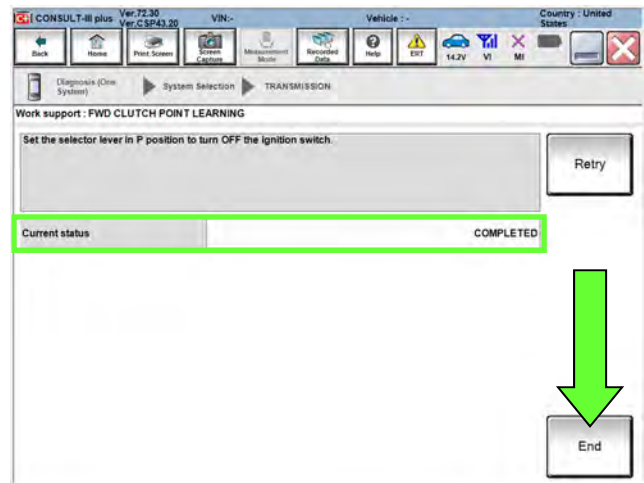

Figure 172

SELECT LEARNING (DRIVE/REVERSE LEARNING)

Perform Select Learning (Drive / Reverse Learning) as follows:

171. Set the parking brake.
172. Start the engine, and then wait five (5) seconds.
173. Move the shift selector to the **N** position and hold for more than two (2) seconds, and then move it to the **D** position and wait for transmission engagement.
174. Repeat step 173 ten times.
175. Move the shift selector to the **N** position and hold for more than 2 seconds, and then move it to the **R** position and wait for the transmission engagement.
176. Repeat step 175 ten times.
177. Move the shift selector to the **P** position, and then turn the ignition OFF.

TROUBLE SHOOTING

The Dummy Cover Will Not Sit Flush

If the dummy cover does not sit flush, the clutch pack may not be fully seated.

- Figure 173 shows the clutch pack fully seated.
- The clutch pack is not fully seated if it is not below the surface that the dummy cover bolts to.
- Use the instructions below to fully seat clutch pack.

NOTE: Always handle the clutch pack by the input shaft.

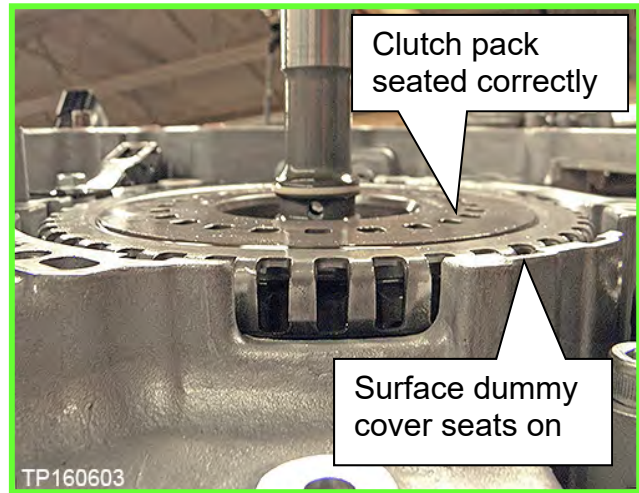

Figure 173

178. Remove the dummy cover.

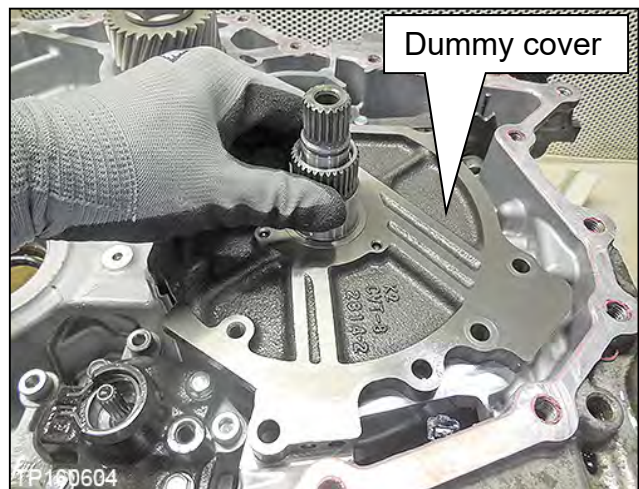

Figure 174

179. Pull up the clutch pack by the input shaft to remove the entire clutch pack.

- Make sure the O-ring is not installed at this time, or it could be damaged during reassembly.

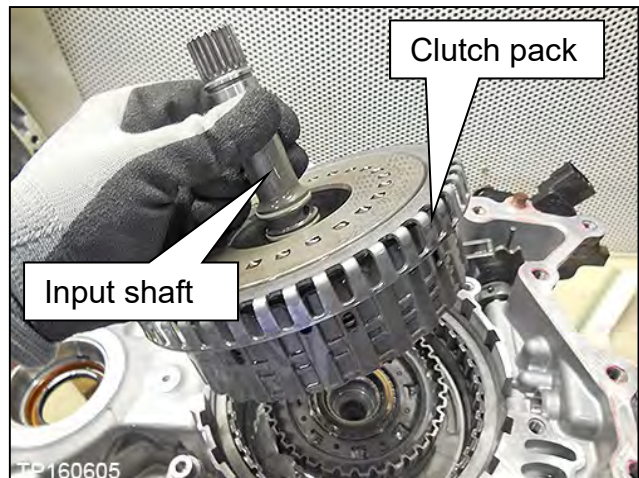

Figure 175

180. Using an appropriate tool, Gently align the layers of the clutch pack.
- Bottom of the clutch pack shown in Figure 176.

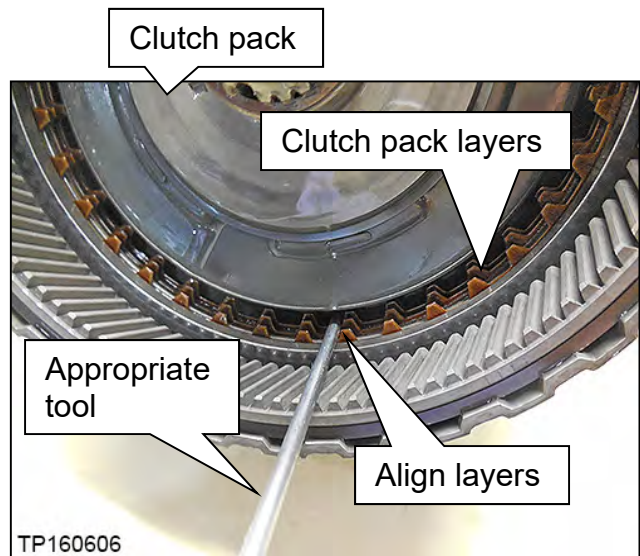

Figure 176

181. Re-insert the entire clutch pack while holding the input shaft.
182. Gently jiggle the input shaft until the clutch pack seats below case lip.
183. If the clutch pack does not seat, rotate back and forth from the input shaft and jiggle.
184. If the clutch pack still does not seat, repeat from step 179.

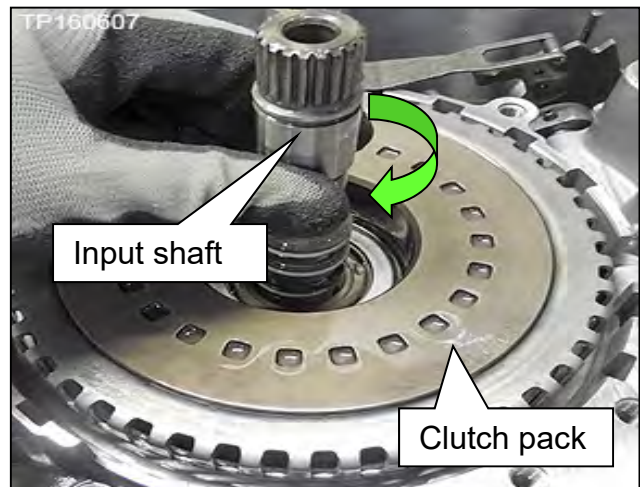

Figure 177

PARTS INFORMATION

The following part kits are only to be used if the Sub-assembly is being replaced.

DESCRIPTION	PART #	QUANTITY	
BELT-PULLEY KIT	Altima	31214-28X9E	
	2014-2016 Rogue and 2017 Rogue AWD	31214-28X9B	1
	2017 Rogue 2WD	31214-28X9C	
CLAMP (Hose Spring Clamp)	16439-7S01E	2	
VALVE ASSY KIT-CONTROL (Valve body)	31705-28X9B	1	
Valve Assy Kit-Control includes:			
VALVE ASSEMBLY-CONTROL (5)		1	
STRAINER ASSY-OIL, AUTO TRANS		1	
BRACKET (Temperature sensor bracket)		1	
BAND (Zip tie for bracket)		1	
GSKT-OIL PAN		1	
SEAL-LIP (Between CVT and control valve)		1	
Seal, O-Ring (fluid filler plug gasket)		1	
SEAL-O RING (Transfer case to CVT AWD only)	33118-4BA0A	1	
WASHER-DRAIN (For drain plug)	11026-JA00A	1	
Loctite 5460 Sealant (1) (3)	999MP-LT5460P	(2)	
Nissan NS-3 CVT Fluid (1) (4)	999MP-CV0NS3	As needed	
Transmission Cooler Cleaner (1)	999MP-AM006P	As needed	

If just a Control Valve is being replaced, use the following parts.

DESCRIPTION	PART #	QUANTITY
VALVE ASSY KIT-CONTROL (Valve body)	31705-28X9B	1
CLAMP (Hose Spring Clamp)	16439-7S01E	2
Valve Assy Kit-Control includes:		
VALVE ASSEMBLY-CONTROL (5)		1
STRAINER ASSY-OIL, AUTO TRANS		1
BRACKET (Temperature sensor bracket)		1
BAND (Zip tie for bracket)		1
GSKT-OIL PAN		1
SEAL-LIP (Between CVT and control valve)		1
Seal, O-Ring (fluid filler plug gasket)		1
WASHER-DRAIN (For drain plug)	11026-JA00A	1
Nissan NS-3 CVT Fluid (1) (4)	999MP-CV0NS3	As needed
Transmission Cooler Cleaner (1)	999MP-AM006P	As needed

- (1) This item can be ordered through the Nissan Maintenance Advantage program: Phone: 877-NIS-NMA1 (877-647-6621) or Website: Order via link on dealer portal www.NNAnet.com and click on the "Maintenance Advantage" link.
- (2) One container of Loctite 5460 Sealant is good for approximately 5 repairs. This sealant is not included in any kit.
- (3) Bill out Loctite 5460 Sealant under **expense code 008**. Do not include the Loctite 5460 Sealant part number on the claim.
- (4) For warranty repairs, Nissan NS-3 CVT Fluid **must** be used. For customer pay repairs, Nissan NS-3 CVT Fluid or an equivalent is recommended.
- (5) Includes QR label, CD-R, and control valve assembly.

CLAIMS INFORMATION

IF Belt Inspection is not Performed and Sub-Assembly is replaced

Submit a Primary Part (PP) type line claim using the following claims coding:

MODEL	OPERATION	PFP	OP CODE	SYM	DIAG	FRT
All	CVT R&R	(1)	JD01AA	ZE	32	(2)
			JD023A			
Altima	Replace CVT Sub-assembly (includes control valve R&I)		JX50AA			3.7
Rogue						3.8
All	Reprogram TCM (when applicable)	JE99AA	(2)			

- (1) Reference the Parts Information Table and use the applicable BELT-PULLEY KIT Part Number 31214-**** as the Primary Failed Part.
- (2) Reference the current Nissan Warranty Flat Rate Manual and use the indicated Flat Rate Time.

NOTE: FRT allows adequate time to access DTC codes. No other diagnostic procedures subsequently required. Do NOT claim any diagnostic OP Codes with this claim.

EXPENSE CODE

EXPENSE CODE	DESCRIPTION	MAX AMOUNT
008	5460 Sealant	\$12.46

Claims Information continued on the next page.

Claims information continued.

OR

If Belt Inspection is Performed and Sub-Assembly is replaced (belt inspection shows signs of belt slip, NG)

Submit a Primary Part (PP) type line claim using the following claims coding:

MODEL	OPERATION	PFP	OP CODE	SYM	DIAG	FRT
All	CVT R&R	(1)	JD01AA	ZE	32	(2)
			JD023A			
Altima	Inspect CVT Chain, Chain = NG (Includes control valve R&I)		JX36AA			1.1
Rogue						
Altima	Replace CVT Sub-assembly		JX45AA			2.9
Rogue						3.0
All	Reprogram TCM (when applicable)	JE99AA	(2)			

- (1) Reference the Parts Information Table and use the applicable BELT-PULLEY KIT Part Number 31214-***** as the Primary Failed Part.
- (2) Reference the current Nissan Warranty Flat Rate Manual and use the indicated Flat Rate Time.

NOTE: FRT allows adequate time to access DTC codes. No other diagnostic procedures subsequently required. Do NOT claim any diagnostic OP Codes with this claim.

EXPENSE CODE

EXPENSE CODE	DESCRIPTION	MAX AMOUNT
008	5460 Sealant	\$12.46

OR

If Only Control Valve is replaced:

Submit a Primary Part (PP) type line claim using the following claims coding:

OPERATION	PFP	OP CODE	SYM	DIAG	FRT
Inspect CVT Chain, Chain = OK	(1)	JX37AA	ZE	32	0.3
Replace Valve Body		JD48AA			(2)
Reprogram TCM (When Applicable)		JE99AA			(2)

- (1) Reference the Parts Information Table and use the VALVE ASSY KIT-CONTROL part number (31705-*****) as the Primary Failed Part.
- (2) Reference the current Nissan Warranty Flat Rate Manual and use the indicated Flat Rate Time.

NOTE: FRT allows adequate time to access DTC codes. No other diagnostic procedures subsequently required. Do NOT claim any diagnostic OP Codes with this claim.

Check-off parts as they are used in the Service Procedure and attach to work order

PARTS KITS REFERENCE TABLE (Parts are listed in order of installation)

CHECK OFF	DESCRIPTION	PART #	QUANTITY	
	PUMP ASSY-OIL Kit 31340-28X8A includes:	PUMP ASSY-OIL	31340-28X0A	1
		SEAL-O RING	31526-28X0C	1 (of 7)
		RING-SNAP	31506-1XF12	1
	SEAL-O RING (O-ring between CVT case and side cover)	31526-28X0A	1	
	PULLEY ASSY - CVT (Belt and pulley "sub-assembly")	Altima	31209-28X9A	1
		2014-2016 Rogue and 2017 Rogue AWD	31209-28X9B	
		2017 Rogue 2WD	31214-28X9C	
	Loctite 5460 Sealant	999MP-LT5460P	As needed	
	BOLT	31377-1XD00 (or 31377-1XZ0B)	19 (of 42)	
	Rogue only	SEAL-O RING (For pulley retainer bolts)	31526-28X0C	6 (of 7)
	SEAL-OIL,DIFF (Differential side oil seal; CVT case side)	38342-3VX0A	1	
	BRG ASSY-THRUST NEEDLE (Thrust bearing)	See page 96	1	
	SEAL ASSY-OIL (Torque converter oil seal; converter housing)	31375-1XF00	1	
	SEAL-OIL,DIFF (Differential side oil seal; converter housing side, front wheel drive only)	38342-3VX0B	1	
	SEAL-O RING (For input shaft)	31526-80X01	1	
	Loctite 5460 Sealant	999MP-LT5460P	As needed	
	BOLT	31377-1XD00	23 (of 42)	
	FLTR ASSY-OIL,AUTO TRANS (CVT fluid filter)	31726-28X0A	1	
	SEAL-O RING (For filter cover)	31526-3VX0A	1	
	SEAL-LIP (Between CVT and control valve)	31528-1XZ0A	1	
	BRACKET (Temperature sensor bracket)	31069-3VX0D	1	
	VALVE ASSY-CONT (Valve body)	31705-28X0B	1	
	BAND (Zip tie for bracket)	24224-3VX0A	1	
	STRAINER ASSY-OIL, AUTO TRANS	31728-28X0A	1	
	GSKT-OIL PAN	31397-1XF0D	1	
	WASHER-DRAIN (For drain plug)	11026-JA00A	1	
	Seal O-Ring (Speed Sensor)	31526-1XG0C	1	
	Transmission Cooler Cleaner	999MP-AM006P	As needed	
	CLAMP (Hose Spring Clamp)	16439-7S01E	2	
	SEAL-O RING (CVT filler plug at converter housing)	31526-3VX0B	1	
	Nissan NS-3 CVT Fluid	999MP-CV0NS3	As needed	
	SEAL-O RING (Transfer case to CVT, AWD only)	33118-4BA0A	1	

THRUST BEARINGS

DESCRIPTION	PART #: 31407-	BEARING THICKNESS	QTY
THRUST BEARING	1XZ0B	3.57	1 of each is included in the Pulley Kit. Select 1 for installation.
	1XZ0C	3.75	
	1XZ0D	3.93	
	1XZ0E	4.1	
	1XZ1A	4.28	
	1XZ1B	4.46	
	1XZ1C	4.61	
	1XZ1D	4.79	

PART KITS VISUAL REFERNECE

- The following Figures show the smaller components of KIT-PULLEY.
- KIT- CONTROL VALVE is not shown.



Figure 178

PUMP ASSY-OIL parts



Figure 179

BRG ASSY-THRUST NEEDLE parts

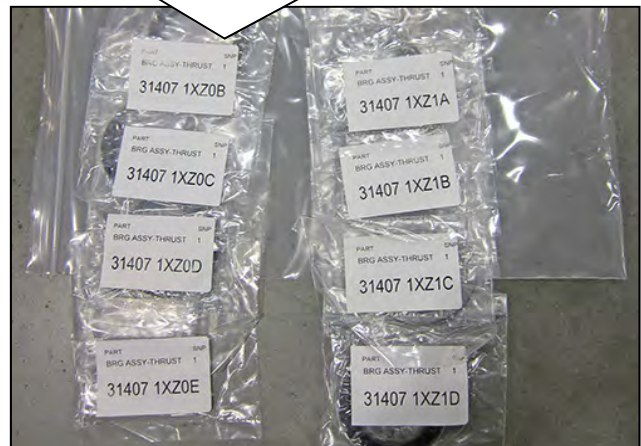

Figure 180

AMENDMENT HISTORY

DATE	REFERENCE	DESCRIPTION
September 14, 2016	NTB16-110	Original bulletin published
February 9, 2017	NTB16-110a	Minor changes made on pages 1, 4, 16, 19, 29, 32, 35, 40, 46, 47, 53, 56, 65, 69 and 83.
April 27, 2017	NTB16-110b	PARTS INFORMATION changed to combine all control valve parts into a single kit.
June 7, 2017	NTB16-110c	Updated figures on page 53.
August 29, 2017	NTB16-110d	Changed IF YOU CONFIRM section, Repair Flow Chart information, and Figures 10G, 3I and 4I.
October 16, 2017	NTB16-110e	Multiple changes throughout.
November 2, 2017	NTB16-110f	Changes to Repair Flow Chart and PARTS INFORMATION section, and included additional service information.
December 19, 2018	NTB16-110g	2013-2014 Altima added to the APPLIED VEHICLES and Table A on page 80; superseded NTB15-084 and NTB15-086. SERVICE PROCEDURE updated on page 81.
March 13, 2018	NTB16-110h	Information added under NOTE on page 1.
July 6, 2018	NTB16-110i	Changes made to IF YOU CONFIRM and CLAIMS INFORMATION sections, and added part numbers to Table B.
October 26, 2018	NTB16-110j	Changes made to IF YOU CONFIRM section and Repair Flow Chart.
December 13, 2018	NTB16-110k	DTC P2813 added to the title, IF YOU CONFIRM section, and Repair Flow Chart.
February 4, 2019	NTB16-110L	Table B, APPLIED VEHICLES, PARTS INFORMATION, and PARTS KITS REFERENCE TABLE sections revised.