

PREVOST

Instruction Sheet

IS-11003F

“MASTER ID” REPLACEMENT WITH “MCM” MODULE

APPLICABLE TO PREVOST VEHICLES FROM 2005 UP TO 2012

REVISION: F THIS INSTRUCTION SHEET SUPERSEDES PREVIOUS VERSION.

Jan 7, 2019: Other parts: Was 563851, is 23317365; was 642206, is 682146.

MATERIAL

Kit #069538 includes the following parts:

Part No.	Description	Qty
069420	MCM HARNESS	1
IS-11003	INSTRUCTION SHEET	1
FI-11003	FEUILLE D'INSTRUCTIONS	1

Other parts that may be required:

Part No.	Description	Qty
23317365	MASTER CHASSIS MODULE (MCM) Master ID must be replaced with MCM #23317365 & harness #069420. Vehicle Identification Number VIN is required for this order. The MCM #23317365 needs to be programmed to this specific VIN prior to shipping to customer. Must be done In a Prevost Service Center with VPG software.	1
*682146	AFTERMARKET BENDIX ABS MODULE WITH ESP *Only for vehicles with ABS Bendix module (Prevost 642083) ABS ECU #682146 needs to be programmed to this specific VIN prior to shipping to customer. Must be done In a Prevost Service Center with ESP software.	1
504637	NYLON CABLE TIE	10-15
563622	BUTT SPLICE	2

NOTE

Material can be obtained through regular channels.

PROCEDURE



DANGER

Park vehicle safely, apply parking brake, stop engine. Prior to working on the vehicle, set the ignition switch to the OFF position and trip the main circuit breakers equipped with a trip button. On Commuter type vehicles, set the battery master switch (master cut-out) to the OFF position.

BEFORE ORDERING, Confirm the Bendix part number of the ABS module on your vehicle:

- A.** If the ABS module on your vehicle has 2 connectors proceed directly to step 1 of the bulletin.

Also, if your vehicle has a **Wabco** ABS module, proceed directly to step 1 of the bulletin.

If module on your vehicles has 4 connectors (Fig.1), proceed below to further identify the module.

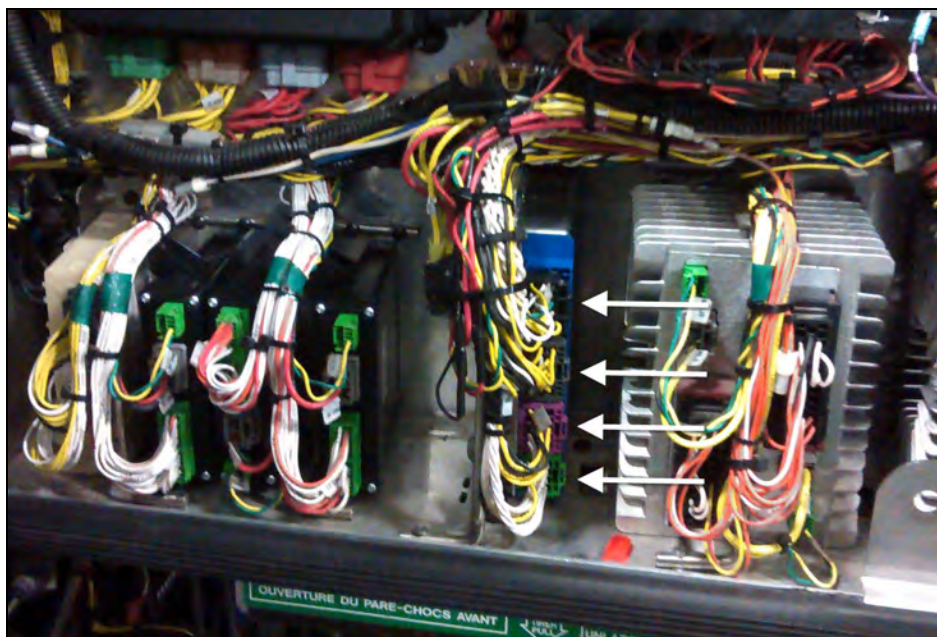

FIGURE 1

- B.** Locate the Bendix label (Figure 2). If number **5019416** or **K023054** appears *in the upper left corner* of the label, this module is NOT compatible with the MCM.
- C.** It must be replaced by module **682146**. Provide your vehicle VIN when ordering. The ABS and MCM modules will be programmed for your vehicle before shipping.



FIGURE 2

D. Follow these instructions once you are ready to replace the module on the vehicle.

- Connect new module.
- Calibrate YAW , Steering and Brake sensor with Bendix ACom diagnostic software.

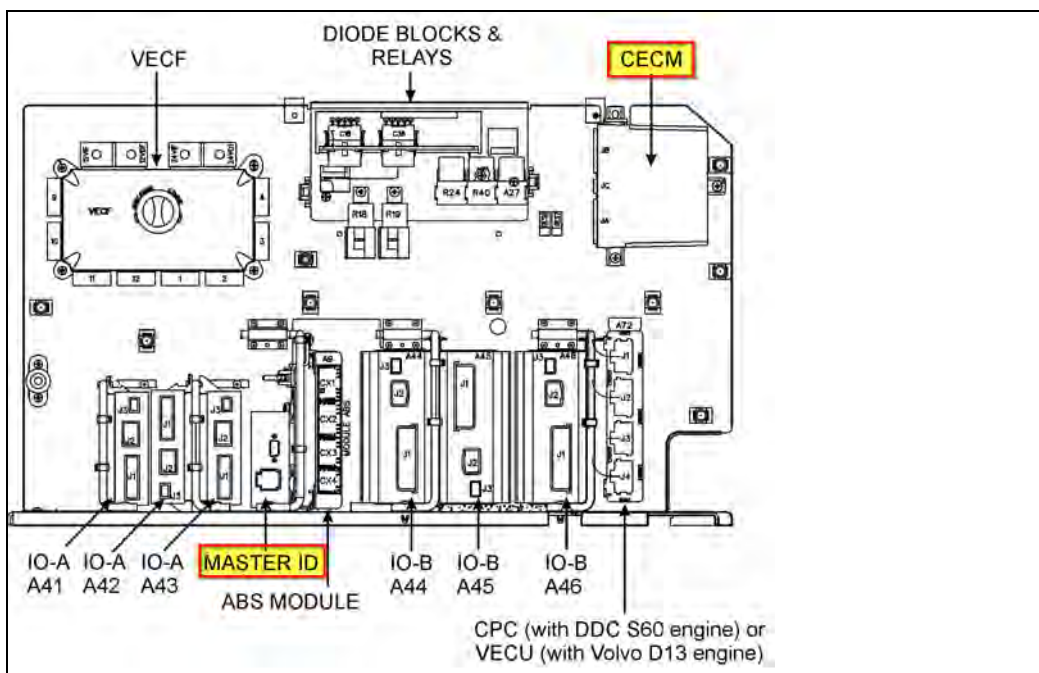

FIGURE 3: FRONT ELECTRICAL COMPARTMENT MASTER ID & CECM LOCATION

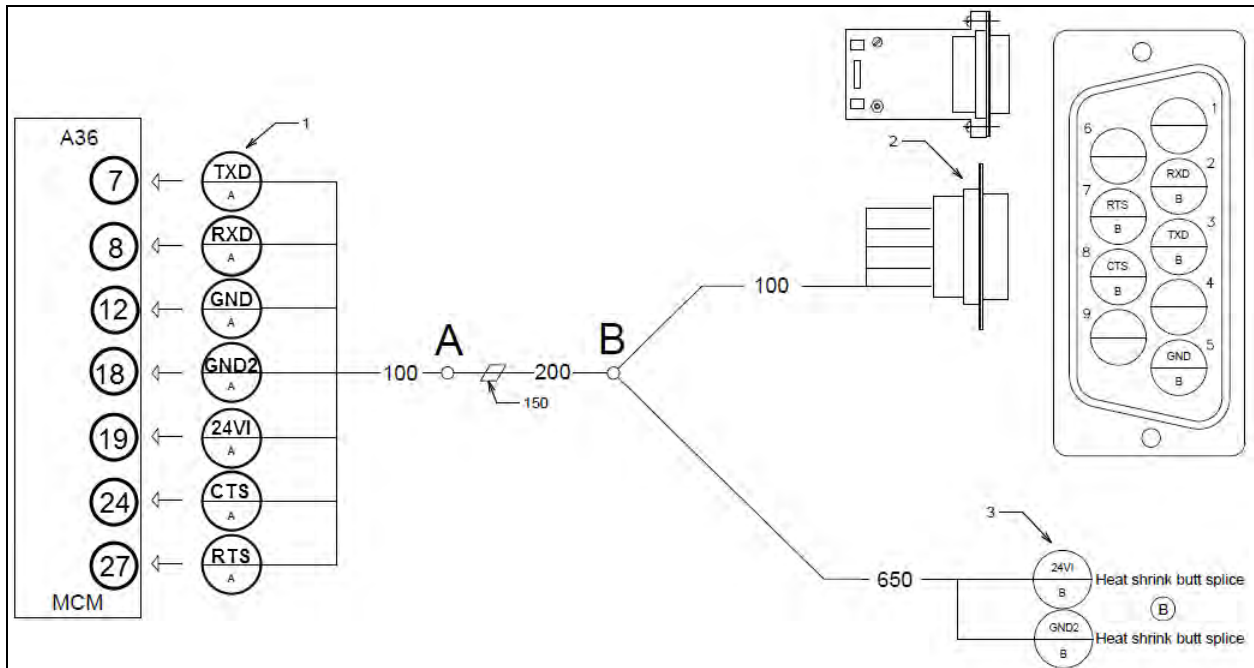
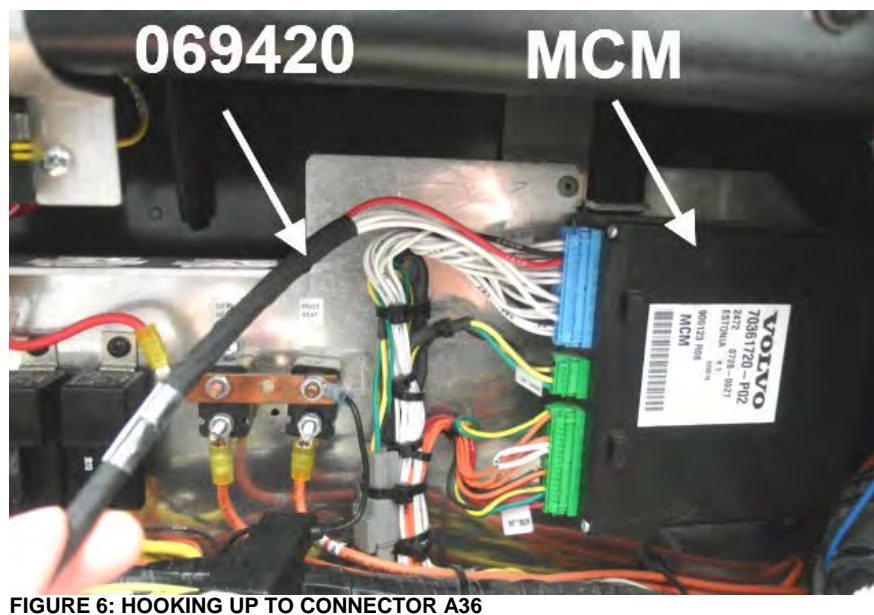
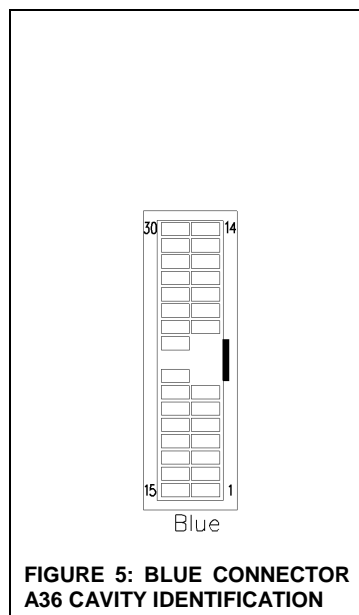
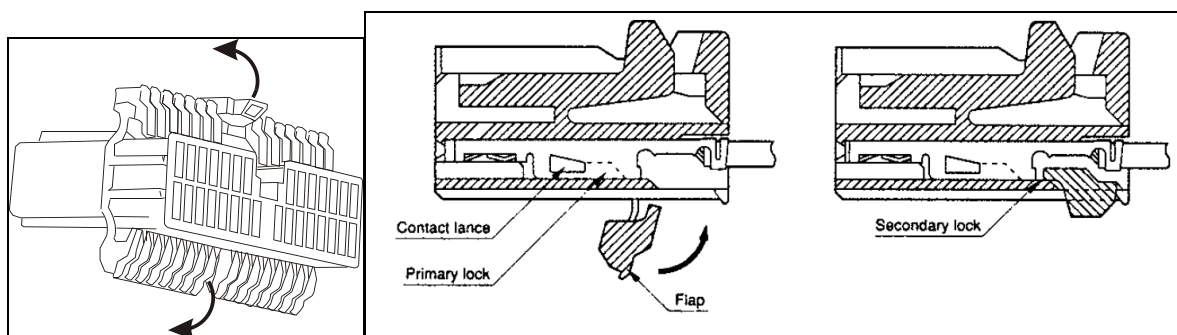

FIGURE 4: HARNESS 069420

1. Disconnect three connectors plugged to the CECM.
2 x green connectors
1 x blue connector
2. Remove and discard the CECM. Keep hardware for reuse.
3. Install the MCM at the CECM location, using existing hardware.
4. Remove and discard the Master ID.
5. Insert circuits TXD, RXD, GND, GND2, 24VI, CTS, RTS of harness 069420 into cavity 7, 8, 12, 18, 19, 24, 27 of blue connector A36.JB (see FIGURE 4, FIGURE 5 & FIGURE 6).
 - Using a small flat blade screwdriver, open proper hinged secondary lock.
 - Insert terminal with flexible lock tabs on the secondary lock side.



6. Cut circuits 24 WUP (red) & GND (black) at the Master ID connector A13.J1.
7. Crimp circuit 24VI (red) & GND2 (black) of harness 069024 to circuits 24 WUP (red) & GND (black) respectively of Master ID connector A13.J1 (see FIGURE 7). Heat up each butt splice shrinking sleeve

(Butt splices may not be installed on first version of this harness, in that situation, use butt splice #563622 if available (2 needed) or solder and cover with heat shrinking sleeve).

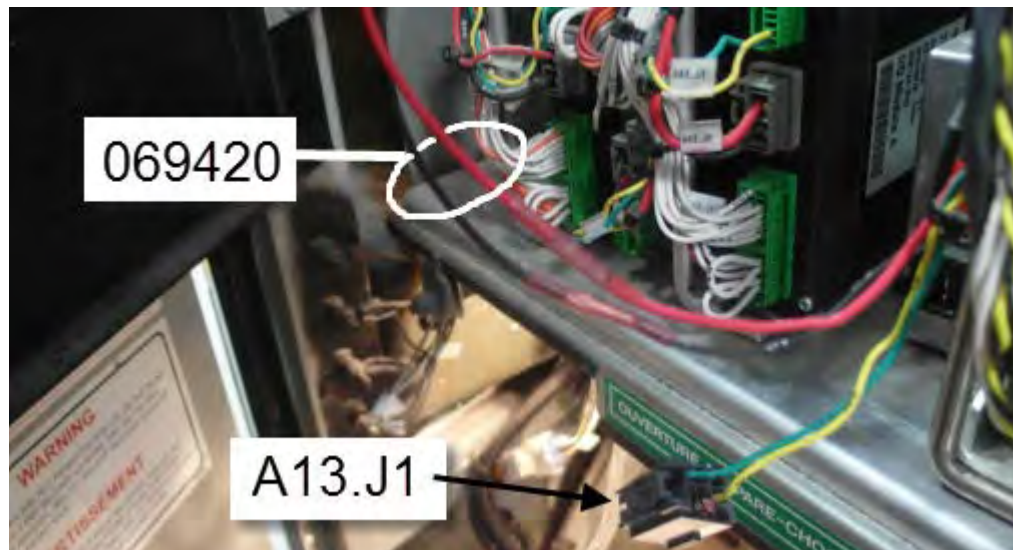

FIGURE 7

8. Secure harness 069420 to surrounding harnesses using nylon ties. Refer to following images as reference.

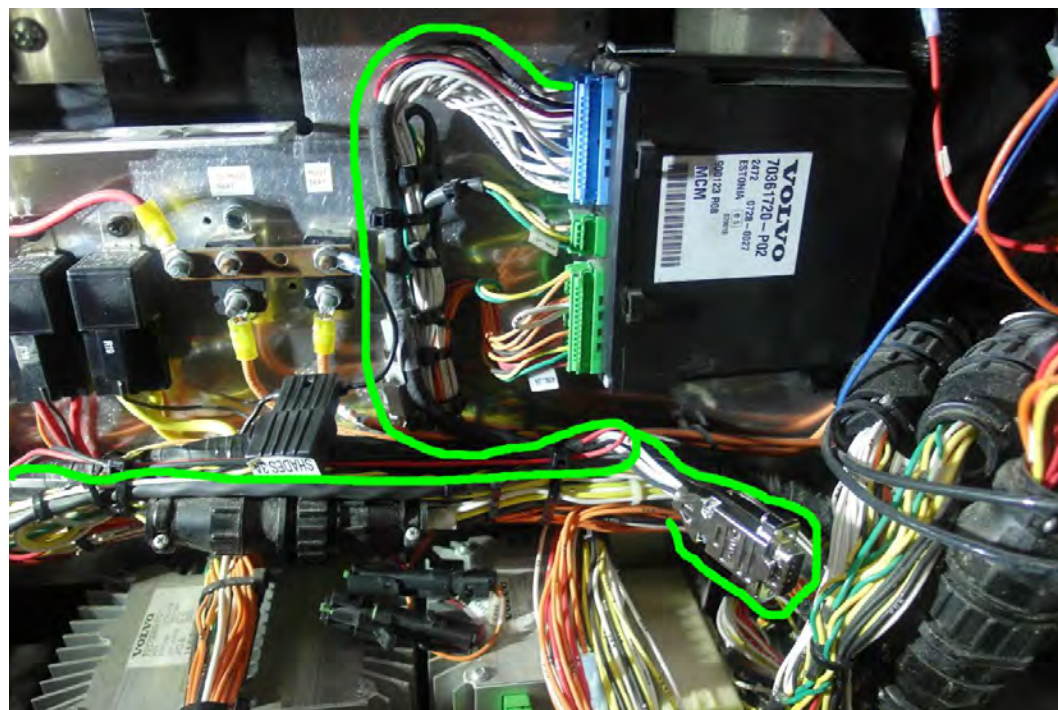

FIGURE 8

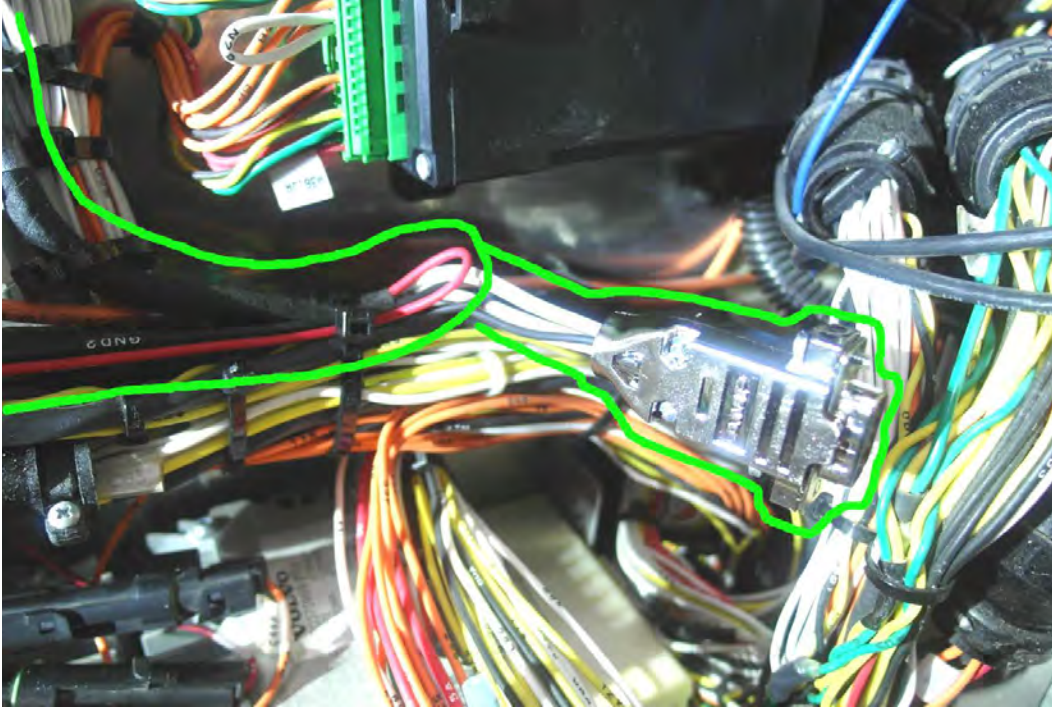

FIGURE 9

PARTS / WASTE DISPOSAL

Discard waste according to applicable environmental regulations (Municipal/State[Prov.]/ Federal)