

Classification:

EL18-040

Reference:

ITB19-002

COPYRIGHT© NISSAN NORTH AMERICA, INC.

Date:

January 15, 2019

2018-2019 INFINITI VEHICLES; DISPLAY CONTROL UNIT SERVICE INFORMATION

APPLIED VEHICLES: 2018-2019 Q50 (V37)
 2018 Q50 Hybrid (V37)
 2018-2019 Q60 (V37)
 2018-2019 Q70 (Y51)
 2018 Q70 Hybrid (Y51)

2018-2019 QX30 (H15)
 2019 QX50 (J55)
 2018-2019 QX60 (L50)
 2018-2019 QX80 (Z62)

SERVICE INFORMATION

If the Display Control Unit (DCU) needs to be replaced on an **APPLIED VEHICLE** for any reason, follow the steps in the Service Procedure to:

- Confirm proper diagnosis and repair with TECH LINE to obtain DCU order approval, then place the order with DENSO.

NOTE: The DCU order approval process does not apply to 2017 model year and earlier models. TECH LINE authorization is not needed for 2017 model year and earlier models.

- Configure the Multi AV system.
- 2018-2019 QX30 vehicles only: Register the replacement DCU. DCU registration is necessary whether or not the vehicle has an active Infiniti InTouch Apps subscription.

Q50, Q60 and QX50 vehicles

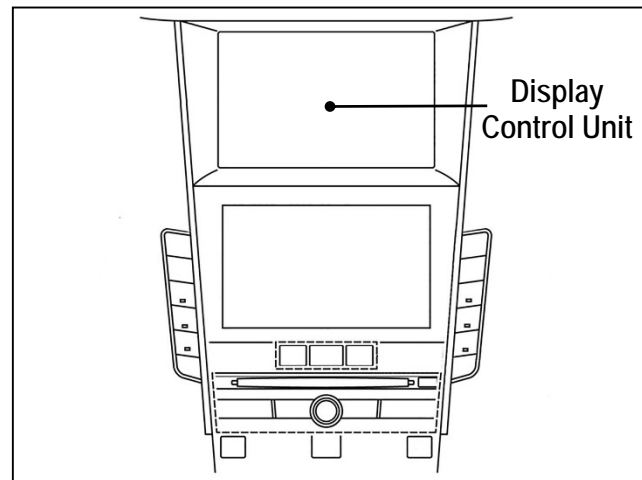

Figure 1

NOTE: The original DCU must be installed in the vehicle while performing part of this procedure. DO NOT remove the original DCU until instructed.

Infiniti Bulletins are intended for use by qualified technicians, not 'do-it-yourselfers'. Qualified technicians are properly trained individuals who have the equipment, tools, safety instruction, and know-how to do a job properly and safely. **NOTE:** If you believe that a described condition may apply to a particular vehicle, DO NOT assume that it does. See your Infiniti retailer to determine if this applies to your vehicle.

SERVICE PROCEDURE

Before starting, make sure your ASIST has been synchronized to the current date and all CONSULT-III plus (C-III plus) upgrades have been installed.

Parts of the Procedure

PART 1: Confirm Proper Diagnosis and Repair with TECH LINE to Obtain DCU Order Approval / Place Order with DENSO

PART 2: Record Multi AV Configuration Values of Original DCU / Replace DCU

PART 3: Configure Multi AV System

PART 4: Manually Configure Multi AV System (**if needed**)

PART 5: 2018-2019 QX30 Vehicles Only – Register Replacement DCU

PART 1: Confirm Proper Diagnosis and Repair with TECH LINE to Obtain DCU Order Approval / Place Order with DENSO

NOTE: The DCU order approval process is to be performed on all 2018-2019 APPLIED VEHICLES and does not apply to all 2017 and earlier models. TECH LINE authorization is not needed for all 2017 and earlier models.

To improve customer satisfaction by providing the correct repair on the first visit, Infiniti has put in place a procedure for ordering an “exchange” or “new” DCU.

- To ensure a proper diagnosis and repair, the technician will need to contact TECH LINE to confirm (or assist with) their diagnosis and the proper repair prior to ordering the DCU.
- DENSO will require a confirmation from TECH LINE prior to shipping an exchange DCU.
- Approval from TECH LINE does not mean the DCU has been ordered. The DCU must be ordered from DENSO.
- New DCUs will be put on **parts restriction** and will need to be cleared before the order is shipped. In the event that a new DCU is required, the warranty claims call center will verify that TECH LINE has recommended replacement.
- This process applies to vehicles equipped with a Navigation system as well as non-Navigation vehicles.

TECH LINE has the support of engineering and DENSO in diagnosis, if needed.

Most DCUs ordered will be an exchange unit versus a new unit.

The requirement of contacting TECH LINE for confirmation to replace a DCU will be monitored to ensure the most effective and accurate method of repair.

In most cases, an exchange DCU will be ordered. A new DCU is required only if:

- The vehicle has not yet been sold.
- The customer requests a new DCU on a non-warranty repair.
- The exchange DCU is not available.
- Insurance claim replacement.

NOTE: While not required, Infiniti recommends using this procedure for non-warranty repairs to ensure that proper diagnosis and repair is performed.

Contact TECH LINE to Confirm DCU Replacement is Needed

NOTE:

- Steps 1-4, below, do not apply to 2017 model year and earlier Infiniti vehicles. Proceed to **Order an Exchange DCU from DENSO** on page 4.
 - Contacting TECH LINE is done to confirm diagnosis. An exchange DCU can be ordered by your parts department directly from DENSO, after approval from TECH LINE.
1. Duplicate and verify the customer's concern if possible. If duplication is not possible, gather as much information about the issue as possible from the service advisor/writer or customer.
 2. Check for any connected devices (phone, iPod, MP3 player, etc.) or determine if a connected device is present during the concern. Gather model and software version information if possible.
 3. Contact TECH LINE after gathering preliminary information of the concern. After diagnosis of the concern has been performed, and the technician and TECH LINE agree that the DCU should be replaced, go to step 4.
 4. TECH LINE will confirm with DENSO, by email, that the diagnosis has occurred and a DCU replacement is approved.

NOTE:

- TECH LINE will not send an email or fax to your parts department.
- Approval from TECH LINE does not mean the DCU has been ordered. The DCU can be ordered from DENSO only after approval from TECH LINE (see page 4).

Order Exchange DCU from DENSO

After steps 1-4 have been completed, your parts department will order the replacement exchange DCU as instructed below.

5. Fill out the DENSO Exchange Order Form and fax or email it to DENSO.

Order forms are found on NNAnet.com:

- a. Log onto NNAnet.com.
- b. Confirm Brand View is Infiniti.
- c. Select **My Links**.
- d. Select **Warranty**.
- e. Select **Electronic Exchange Information – Infiniti**.
- f. Scroll down to **Denso**, and then click on **Link to Denso Order Form**.
- g. Fill out the form. Be sure to use the DCU part number in the **Exchange Part #:** field.

NOTE: The DCU part number can be found on the label on the back of the DCU, or with CONSULT-III plus by going to Diagnosis (One System) > MULTI AV > ECU Identification.

6. **After** the order is submitted, **and after** TECH LINE has submitted authorization by email, **then** DENSO will email confirmation to your parts department that the order has been placed.*

* The DCU order approval process does not apply to all 2017 model year and earlier Infiniti models. TECH LINE authorization is not needed for all 2017 and earlier models.

PART 2: Record Multi AV Configuration Values of Original DCU / Replace DCU

7. Prepare the vehicle.

- Make sure the shift selector is in Park, and the parking brake is set.
- Connect the GR8 to the 12V battery and select **ECM Power Supply Mode**.
- Connect the plus VI to the vehicle.
- Launch C-III plus on the CONSULT PC.
- Turn the ignition ON. **DO NOT** start the engine.
 - Hybrid vehicles: Turn the ignition to ON. **DO NOT** put in Ready Mode.

8. Select Re/programming Configuration.

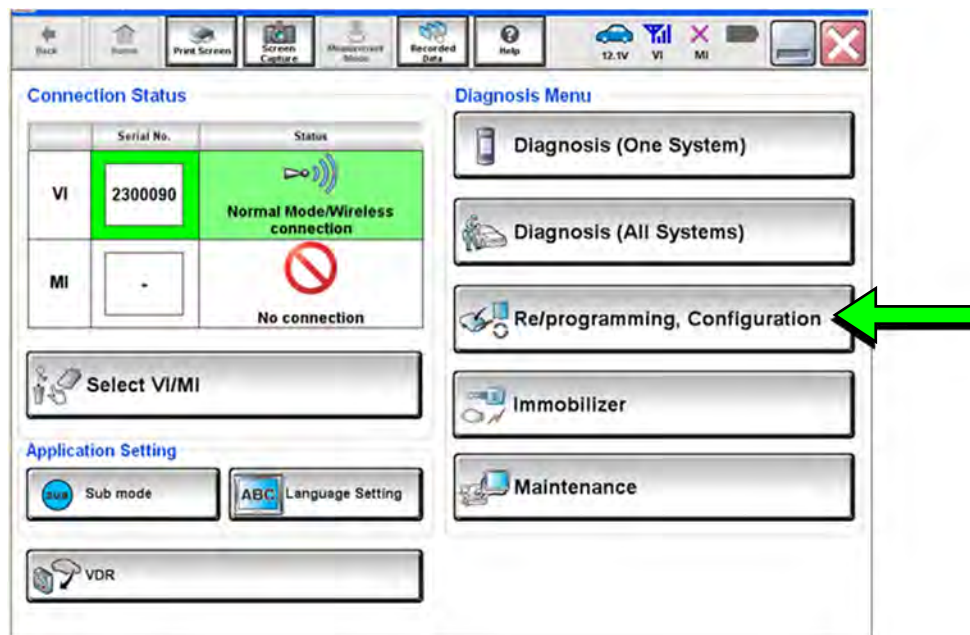

Figure 2

Steps 13 and 14 below apply to 2018-2019 QX30 vehicles ONLY. For all other vehicles, proceed to step 15 on the next page.

13. Select **USA/CANADA Dealers** in the drop down menu, and then select **OK**.

NOTE:

- The screen in Figure 6 will only appear during the first login on a CONSULT PC. Future logins with same CONSULT PC will display the screen in Figure 7 only.
- If the screen shown in Figure 6 does not display, proceed to step 14.

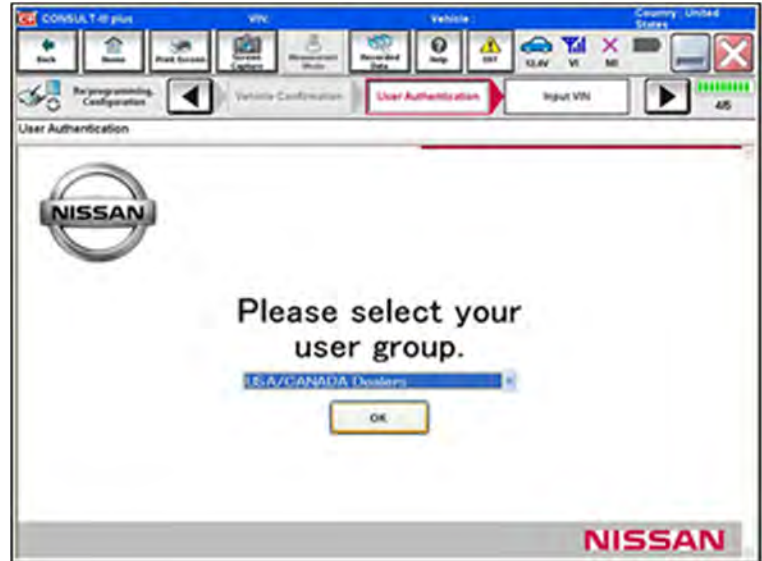

Figure 6

14. Enter your NNAnet.com **Username** and **Password**, and then select **Submit**.

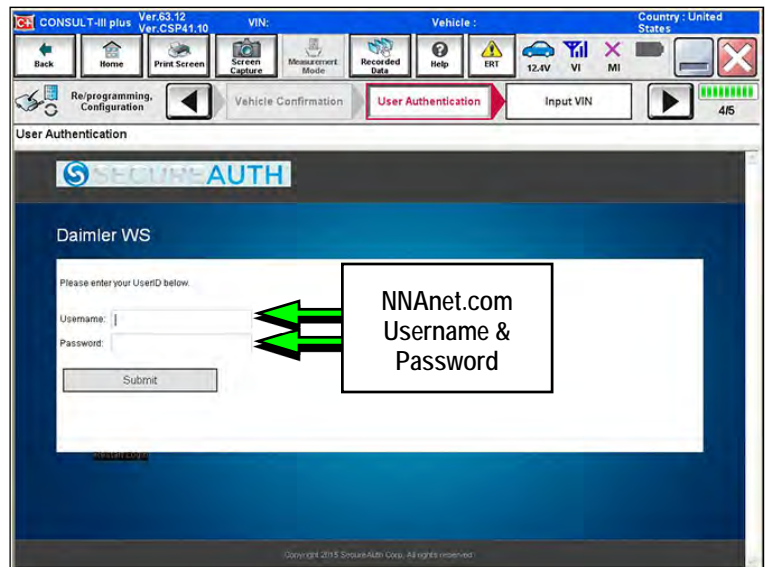

Figure 7

15. After System Call completes, confirm the correct Vehicle Identification Number (VIN) is displayed.

- When finished, select **Confirm**.

NOTE: If the VIN displayed is incorrect, input the correct VIN. When finished, select **Confirm**.

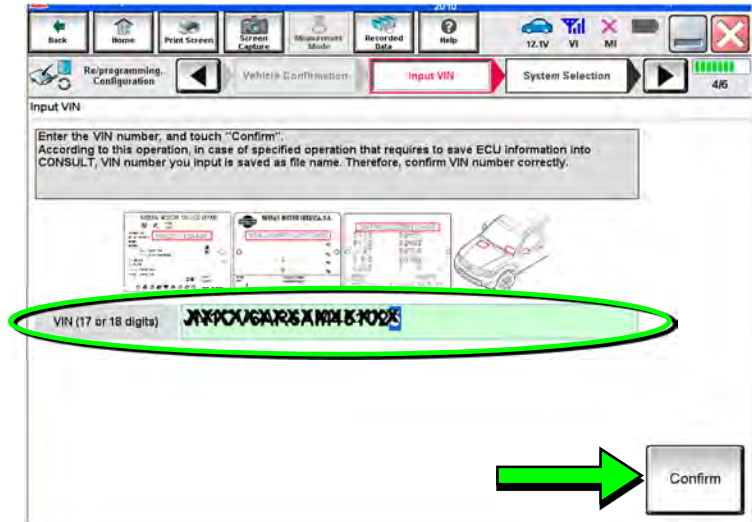

Figure 8

16. Select **MULTI AV**.

- Use the scroll arrows if needed.

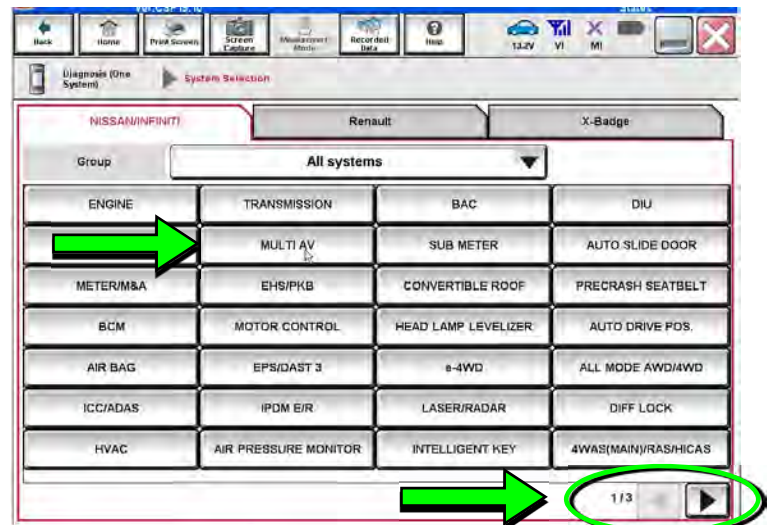

Figure 9

17. Select **Before ECU Replacement**.

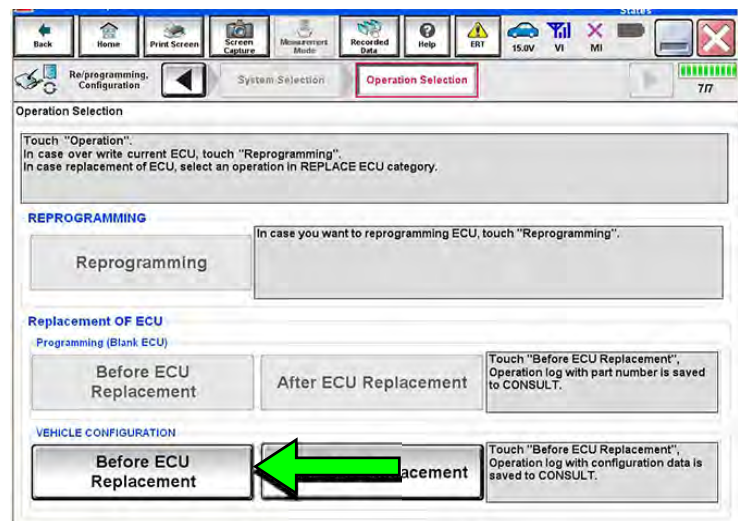

Figure 10

PART 3: Configure Multi AV System

22. Perform steps 7-15 again before proceeding to step 23.

23. When you get to the screen shown in Figure 13, select **Confirm**.

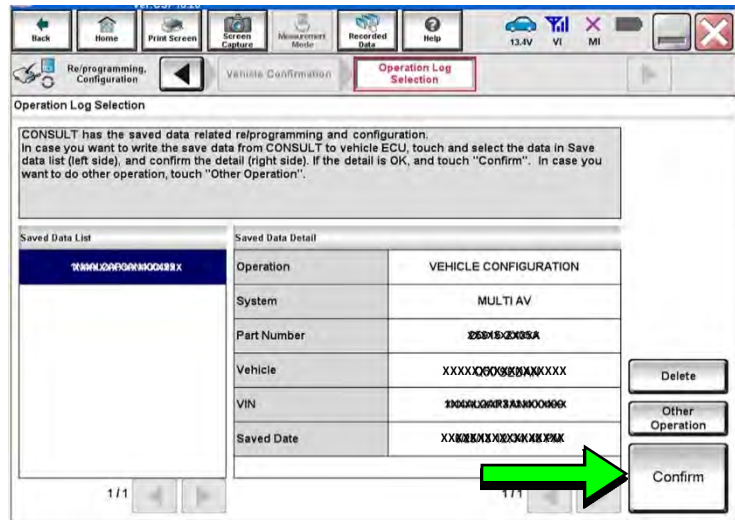

Figure 13

24. If the screen in Figure 14 appears, skip to page 14, step 35.

25. If the screen in Figure 14 does not appear, go to step 26.

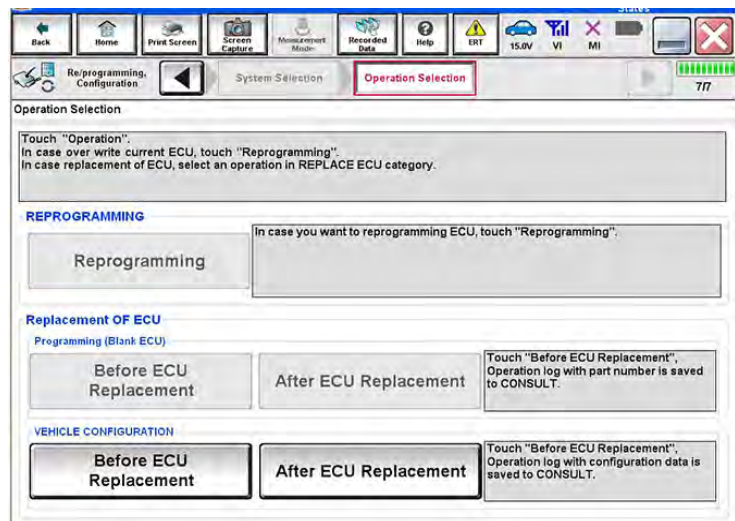

Figure 14

26. Select OK.

After performing Step 26:

- If an error message does not display, proceed to page 15, step 39.
- If an error message does display, proceed to **PART 4: Manually Configure the Multi AV System (if needed)**, below.



Figure 15



PART 4: Manually Configure the Multi AV System (if needed)

NOTE: If the screen in Figure 16 is not displayed, click on the **Home** icon.

27. Select **Re/programming Configuration**.

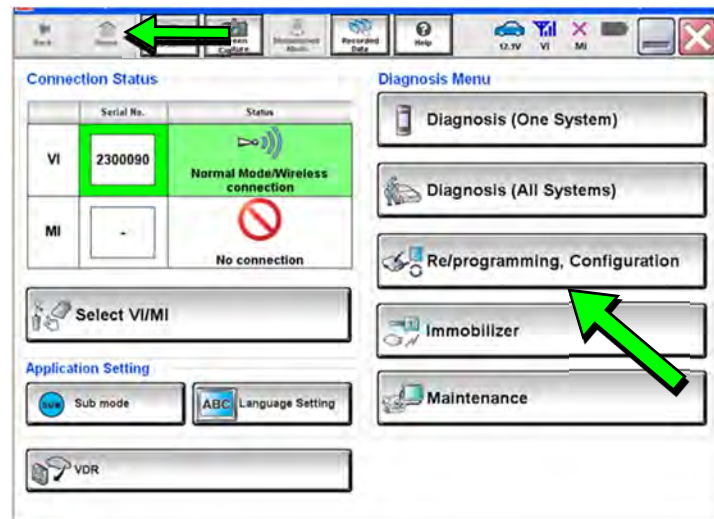

Figure 16

28. Read the **Precautions**.

When finished, click in the **Confirmed instructions** box to insert a check mark, and then select **Next**.

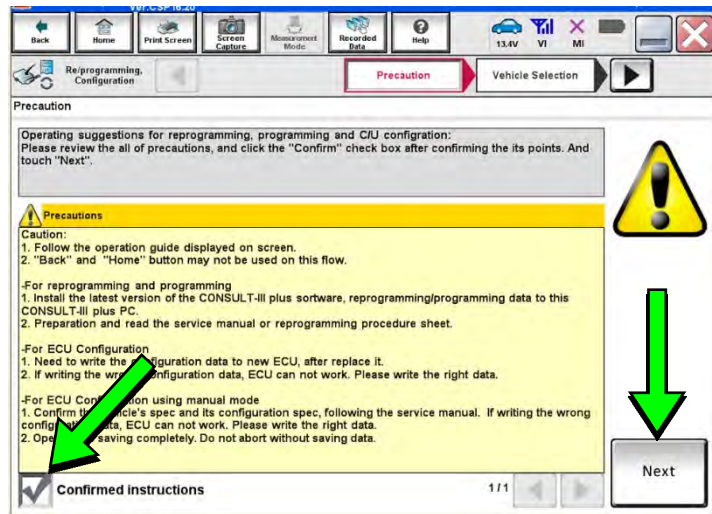

Figure 17

29. Select the **Manual Selection (Vehicle Name)** tab, and then select the **Vehicle Name** and **Model Year**.

NOTE: If the screen shown in Figure 18 does not display, proceed to the next page, step 32.

30. Select **Select**.

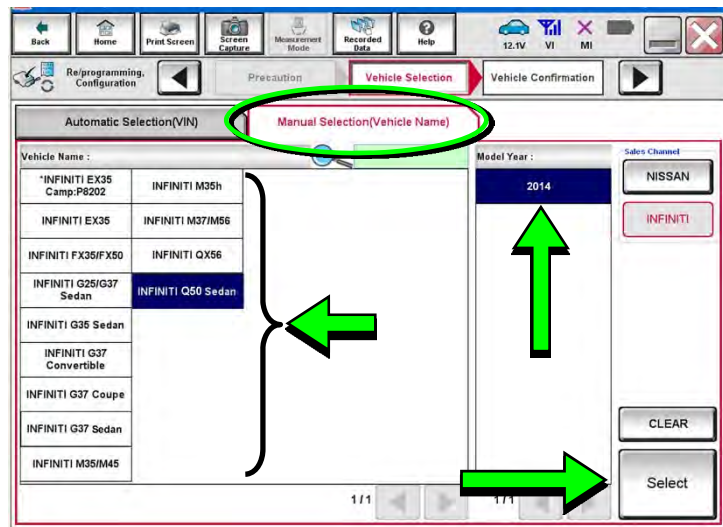

Figure 18

31. Confirm the correct **Vehicle Name** and **Model Year** are displayed.

When finished, select **Confirm**.

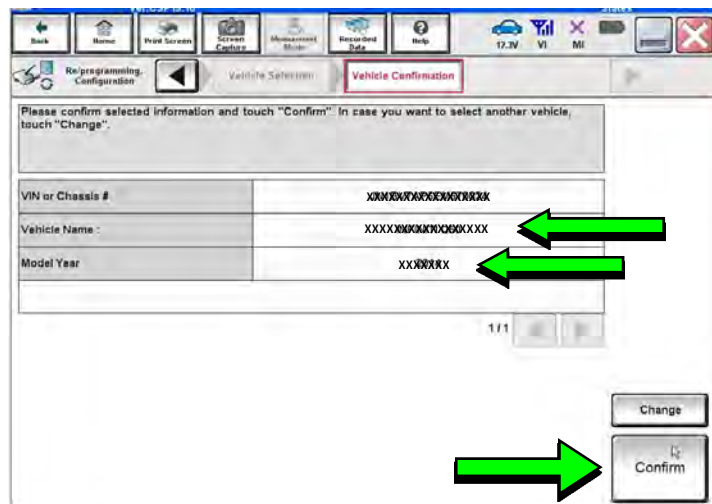

Figure 19

Step 32 below applies to 2018-2019 QX30 vehicles ONLY. For all other vehicles, skip to step 33.

32. Enter your NNAnet.com Username and Password, and then select **Submit**.

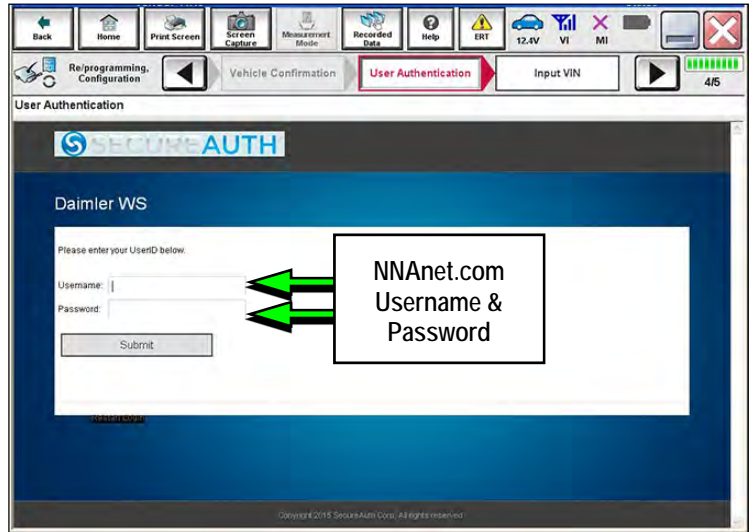

Figure 20

33. Confirm the correct VIN is displayed.

When finished, select **Confirm**.

NOTE: If the VIN displayed is incorrect, input the correct VIN. When finished, select **Confirm**.

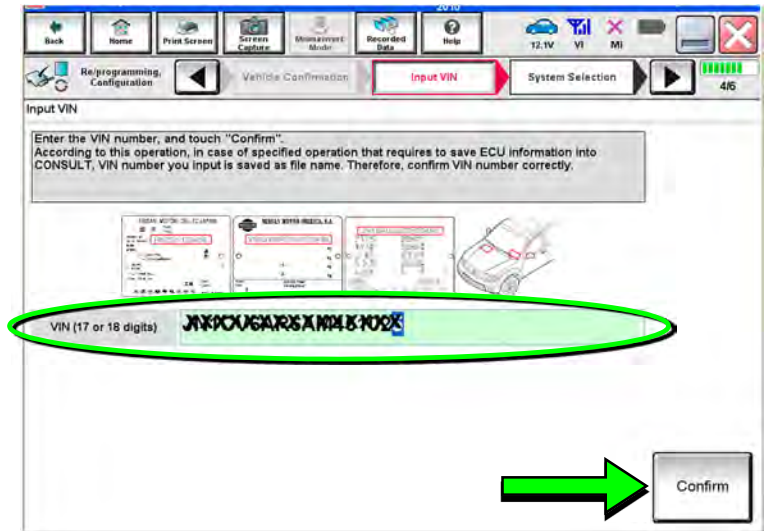

Figure 21

34. Select **MULTI AV**.

- Use the scroll arrows if needed.

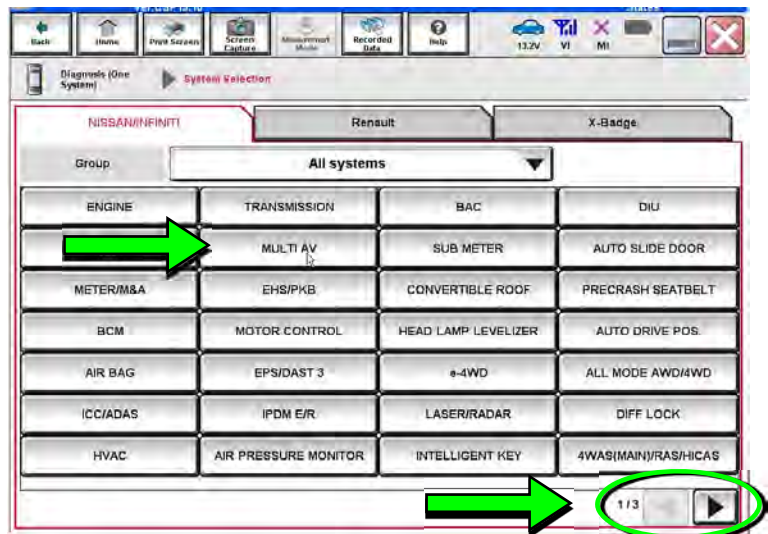

Figure 22

35. Select After ECU Replacement.

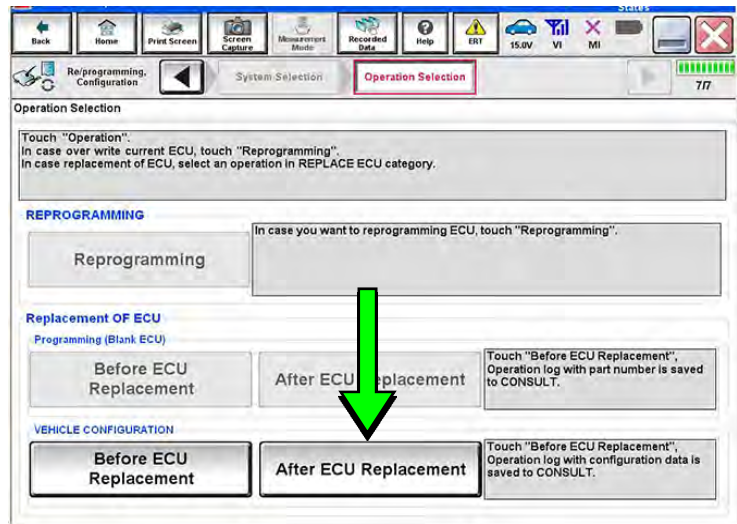

Figure 23

36. Select Manual selection.

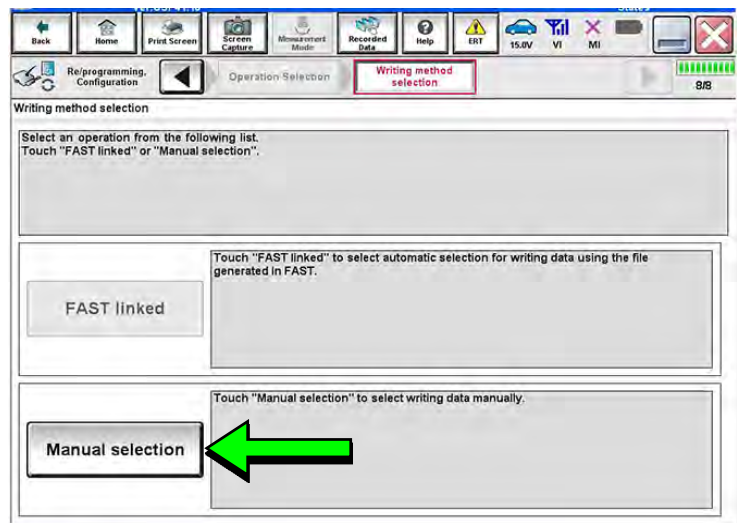

Figure 24

37. Use the drop down menus to select the configuration options that were printed or written down in step 18.

- Use the scroll arrow if more than one page of information is available.

NOTE: Configurable options may differ and look different from Figure 25.

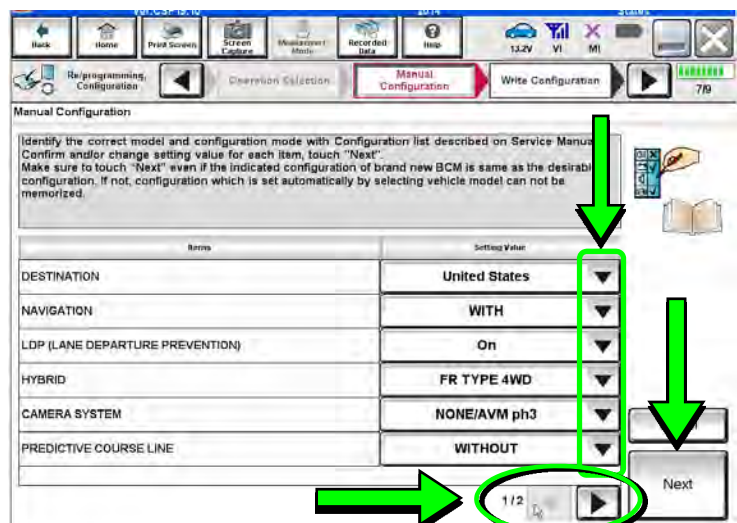

Figure 25

38. Confirm the configuration items displayed under **Setting Value** are correct, and then select **OK**.

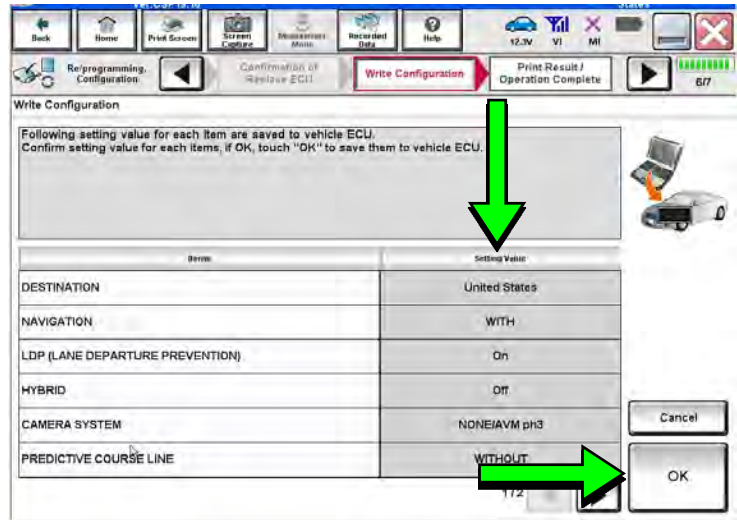

Figure 26

39. Turn the ignition OFF, and then start the engine.

40. After starting the engine, wait for about 30 seconds.

41. Use C-III plus to erase any codes from the Multi AV system.

- a. Select Home on the C-III plus screen.
- b. Select **Diagnosis (One System) > Multi AV > Self Diagnosis Results**.
- c. Erase any codes that may be present.

Step 42 below applies to 2018-2019 QX30 vehicles ONLY. For all other vehicles, proceed to step 43.

42. Write down the **UNIT ID** number (see Figure 27) as follows:

NOTE: The **UNIT ID** number will be used in Part 5 of the procedure.

- a. Select the **ECU Identification** tab on the C-III plus screen.
- b. Write down the **UNIT ID** number.

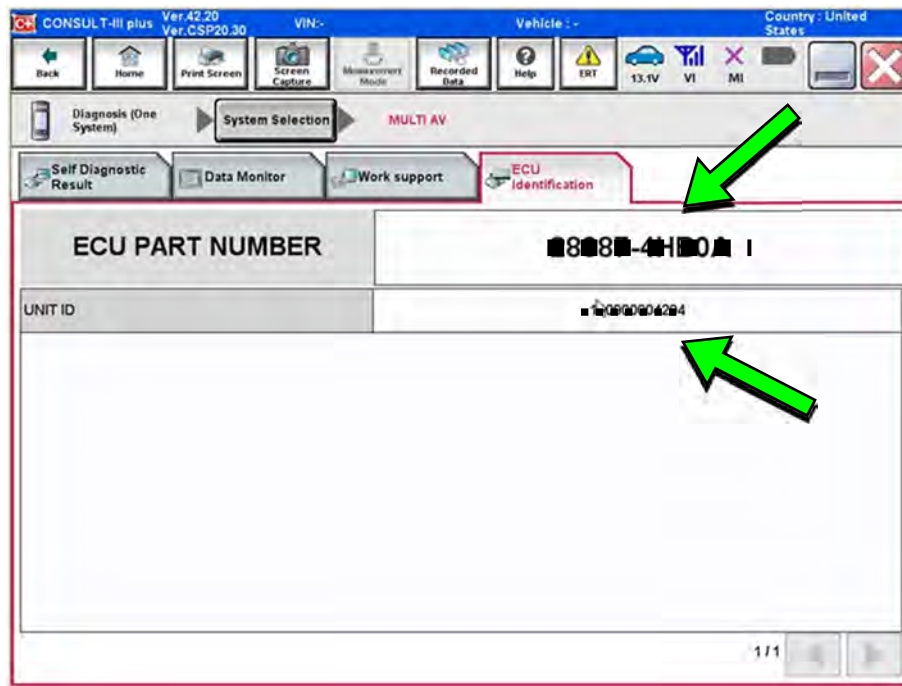

Figure 27

43. Close C-III plus and disconnect the plus VI from the vehicle.

44. Check that the operation of the DCU and, if equipped, RearView Monitor camera images (fixed guide lines and predictive course lines) are normal.

45. Disconnect the GR8 from the 12V battery.

2018-2019 QX30 vehicles only: Go to the next page.

PART 5: 2018-2019 QX30 Vehicles ONLY – Register Replacement DCU

46. Register the replacement DCU by calling Infiniti Owner Services at **1-855-444-7244**. Listen to the prompts and select the option for the **“Infiniti Connection Specialist.”**

- During this call you will be asked for the **UNIT ID** number (see step 42) and Vehicle Identification Number (VIN).
- Infiniti Owner Services hours of operation are:

Monday – Saturday: 8:00am to Midnight EST
Closed Thanksgiving, Christmas, and New Years Day

IMPORTANT: Step 46 MUST be performed to register the replacement DCU. If this step is not performed, the Infiniti InTouch Apps feature – if the vehicle has an active subscription – will not function. Perform this step even if the vehicle does not have an active Infiniti InTouch Apps subscription, as future enrollment will also be affected.

AMENDMENT HISTORY

PUBLISHED DATE	REFERENCE	DESCRIPTION
January 15, 2019	ITB19-002	Original bulletin published.