



# Technical Journal

TITLE:

**End pieces available for luggage cover**

<b>REF NO:</b> TJ 33514.1.0	<b>ISSUING DEPARTMENT:</b> Technical Service	<b>CAR MARKET:</b> United States and Canada	
<b>PARTNER:</b> 3 US 7510 Volvo Car USA		<b>ISSUE DATE:</b> 2018-03-27	<b>STATUS DATE:</b> 2018-04-04
<b>FUNC GROUP:</b> 8510	<b>FUNC DESC:</b> Upholstery for wall/door, side, rear she	Page 1 of 7	

“Right first time in Time”

## Attachment

File Name	File Size
TJ 33514.pdf	0.8940 MB

## Vehicle Type

Type	Eng	Eng Desc	Sales	Body	Gear	Steer	Model Year	Plant	Chassis range	Struc Week Range
235							2017-9999		0000160-0999999	201624-999952
236							2017-9999		0000098-0999999	201646-999952
256							2016-9999		0000561-0999999	201505-999952

## CSC Customer Symptom Codes

Code	Description
WF	Cargo area cover/Does not work properly

## VST Operation Number

VST Operation Number	Description
VST Operation No.	Description
85108-2	End Piece luggage cover 1 pc replace



**DTC** Diagnostic Trouble Codes

**Text**

**DESCRIPTION:**

If an end piece on the luggage cover is broken, replace only the end piece and not the complete luggage cover.

**SERVICE:**

Follow instruction "TJ 33514.pdf.

**VEHICLE REPORT:**

Yes, please submit a Vehicle Report if the service solution described in this TJ has no effect. Use concern area "Vehicle Report" and sub concern area "Support not needed", use function group 8510.

**To view TJ attachment continue to next page. This TJ has one attachment.**



## Volvo Car Customer Service

## TJ Instruction VCC-511555-1

<b>Title</b>	Cargo compartment cover	<b>Page</b>	1 ( 5 )
<b>Action</b>	Product fix	<b>Operation number:</b>	85108-2

Issue	Date	Reason
1	2018-03	First issue

### Affected vehicles

Model year	Model
2017, 2018	V90 (17-)
2017, 2018	V90 Cross Country
2016, 2017, 2018	XC90 (16-)

### Materials

Materials	Qty.	Part No.	Notes
Catch	1.0	32239158	Left, Charcoal, V90, V90CC;
Catch	1.0	32239159	Right, Charcoal, V90, V90CC;
Catch	1.0	32239160	Left, Blonde, V90, V90CC;
Catch	1.0	32239161	Right, Blonde, V90, V90CC;
Blind rivet	1.0	973881	
Catch	1.0	32239166	Left, Interior code RXX, UXXX, WXXX; XC90;
Catch	1.0	32239167	Right, Interior code RXXX, UXXX, WXXX, XC90;
Catch	1.0	39832094	Left, Interior code QXXX, XC90;
Catch	1.0	39832096	Right, Interior code QXXX, XC90;

### Equipment

Designation	Part No.
Pop rivet pliers	

Removal

Note! Removal steps in this procedure may contain installation details.

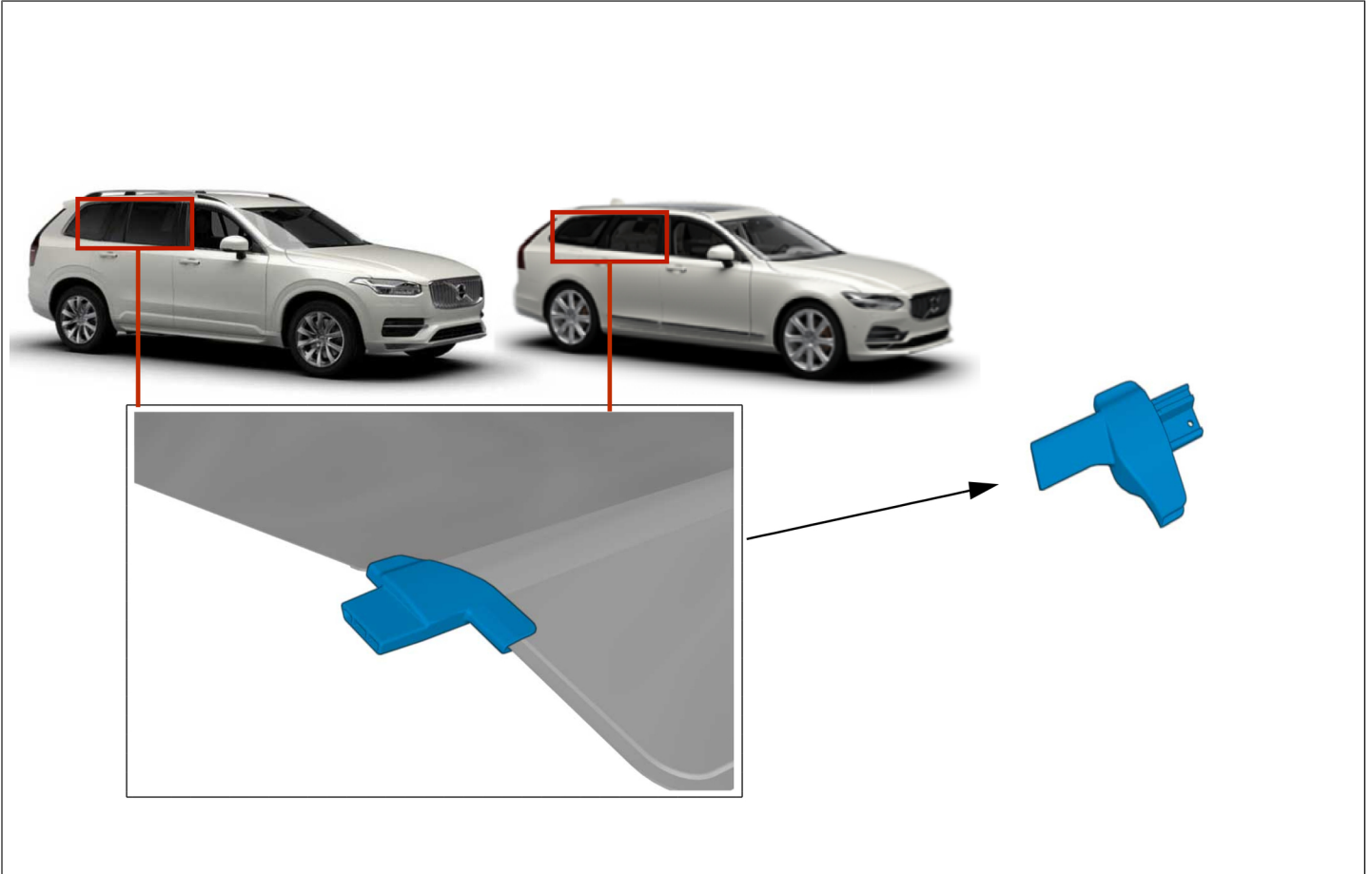

## Color symbols

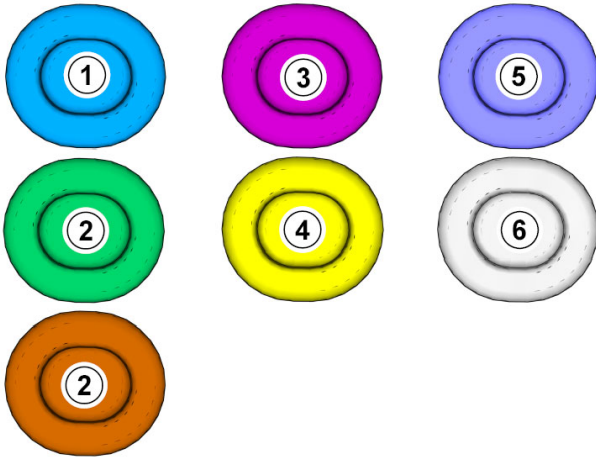

**Note! This colour chart displays (in colour print and electronic version) the importance of the different colours used in the images of the method steps.**

- 1 . Used for focused component, the component with which you will do something.
- 2 . Used as extra colors when you need to show or differentiate additional parts.
- 3 . Used for attachments that are to be removed/installed. May be screws, clips, connectors, etc.
- 4 . Used when the component is not fully removed from the vehicle but only hung to the side.
- 5 . Used for standard tools and special tools.
- 6 . Used as background color for vehicle components.

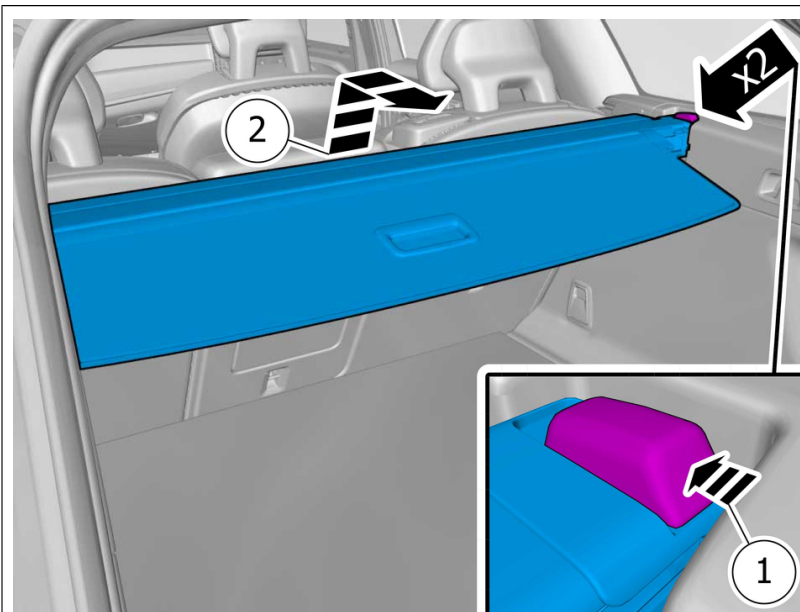

Remove the marked part.

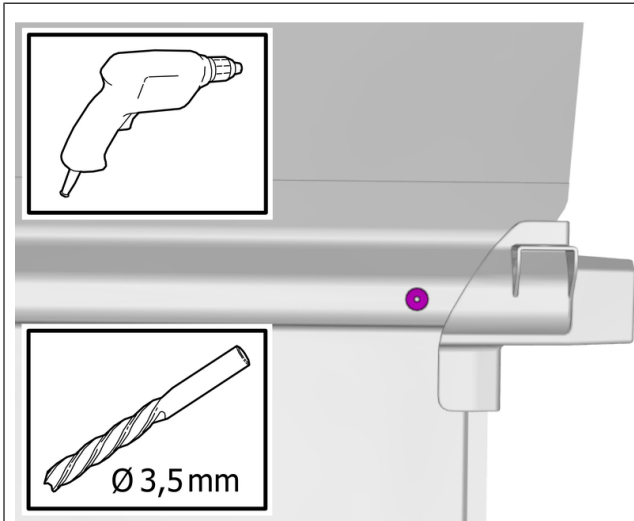

**Caution! Observe caution when carrying out this step.**

Use a drill with the stated size  
Remove the fastener.

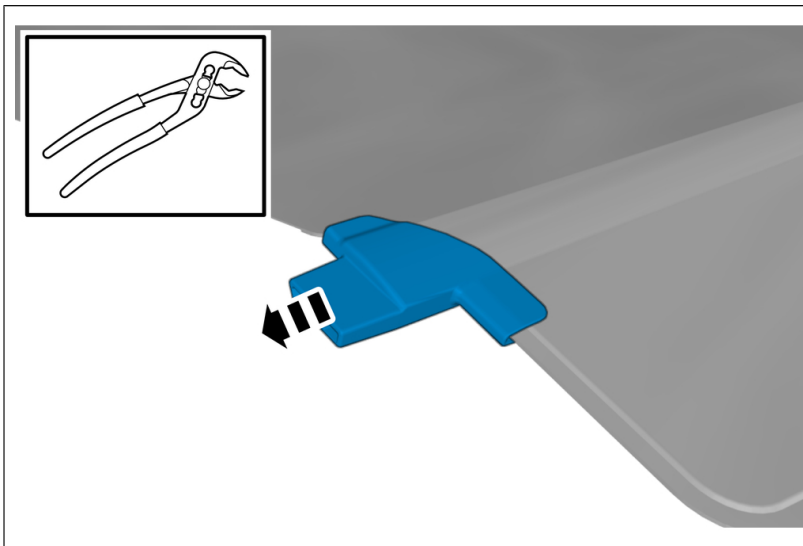

Remove the marked part.

### Installation

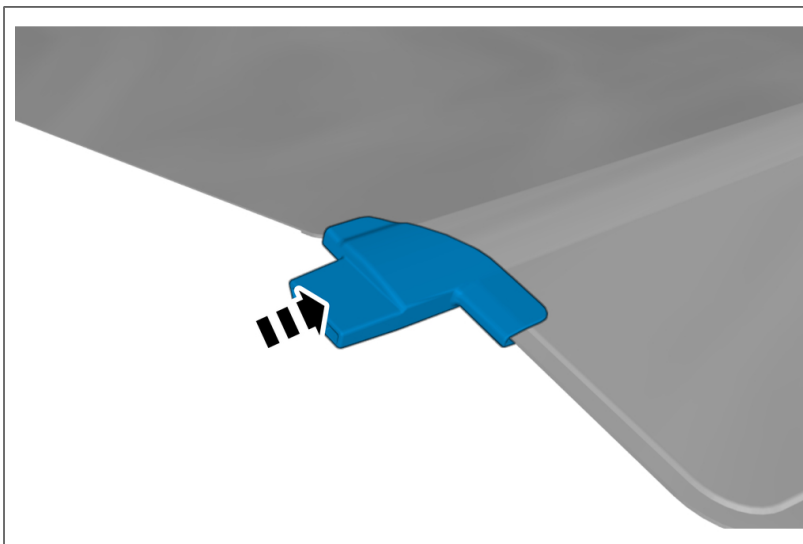

Install the marked component.

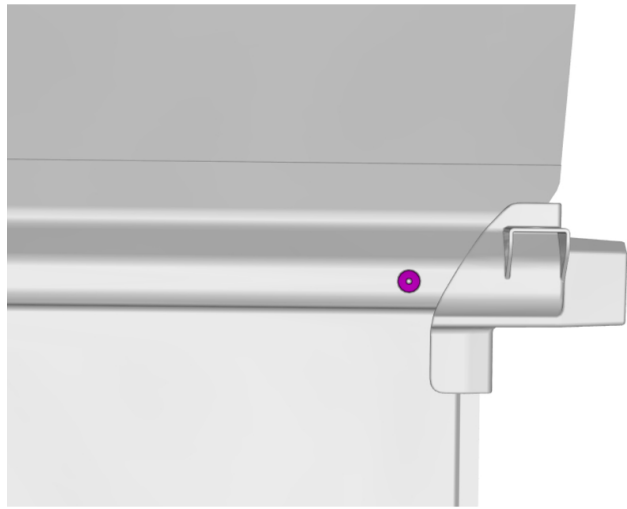

**Note! Only use the specified material.**

Install the marked component.

**Use:** Pop rivet pliers

To install, reverse the removal procedure.