



Jason Guidi

Director - Regulatory & Compliance

August 15, 2018
Subject: Recall R89898
TO: All U.S. and Canadian Volvo Retailers

VEHICLES IN RETAILER INVENTORY

It is a violation of federal law for a retailer to deliver any new Volvo that is eligible for a recall. Retailers are advised to check all vehicles in inventory for recall eligibility and repair immediately. Violation of this requirement by a retailer could result in a civil penalty of up to \$21,000 per vehicle.

Correct all vehicles in your new vehicle inventory before delivery.

Volvo Car USA LLC and Volvo Car Canada LTD (Volvo) on behalf of Volvo Car Group has decided to launch Recall R89898 on a **limited** number of model year 2019 XC40 vehicles.

Volvo has identified that the rear seatback lock striker(s) may not have been installed when the vehicle was manufactured.

PLEASE NOTE

The corrective action is to inspect the vehicle and verify that both rear seatback lock strikers are installed. If the rear seatback lock strikers are installed on the vehicle, no further action is necessary.

If one or both rear seatback strikers are missing, install them per the instructions below.

A total of 27 U.S. and 10 Canadian vehicles are eligible for this recall.

Vehicle eligibility must be confirmed:

- Vehicle Inquiry – Vehicle Warranty where the message "Recall R89898 Rear Seatback Lock Striker" will appear for eligible vehicles.
- All cars not yet delivered to end customers must be corrected prior to delivery.
- There have been no reports of incidents related to this issue.



If you have any questions concerning this recall send them to recall@volvocars.com.

OWNER NOTIFICATION

Volvo Customer Care will contact the vehicle owners and will assist with arranging appointments with the selling retailer.

PORT VEHICLES

No vehicles will be shipped from the ports with this recall not completed.

PARTS / PARTS RETURN

Please refer to Parts Bulletin 85-R89898.

CLAIM SUBMISSION

Please refer to the claim submission information in the attached Quality Bulletin.

RETAILER RESPONSIBILITIES

Retailers must perform this recall campaign on eligible vehicles regardless of miles/kilometers or vehicle age. All work performed under this recall is free of charge to the owner.

As the safety of our customers is our utmost priority, we are taking full responsibility to ensure the highest quality and safety standards for our cars.

If you have questions about this recall or any other field service action, please contact me or any member of the Product Safety and Compliance office.

Your cooperation in completing this important recall is greatly appreciated.

Drive Safely,

A handwritten signature in black ink that reads "Jason J. Guidi".

Jason Guidi
Director - Regulatory & Compliance
201-768-7300
jason.guidi@volvocars.com



Recall R89898: Rear Seatback Lock Strikers

MODEL YEAR 2019

MODEL: XC40

DATE: 08/15/18

MARKET – U.S. AND CANADA

ISSUING DEPARTMENT: WARRANTY

BULLETIN REFERENCE PB 85-R89898

A. RECALL R89898 DESCRIPTION

B. VEHICLES INVOLVED

C. PARTS INFORMATION/PARTS RETURN

D. OWNER NOTIFICATION

E. VEHICLES IN RETAILER INVENTORY

F. RETAILER RESPONSIBILITY

G. CAMPAIGN REIMBURSEMENT PROCEDURES

H. TECHNICIAN COMPETENCY REQUIREMENT

I. RETAILER ALLOWANCE

A. RECALL R89898 DESCRIPTION

Volvo Car USA LLC and Volvo Car Canada LTD (Volvo) on behalf of Volvo Car Group has decided to launch Recall R89898 on a **limited** number of model year 2019 XC40 vehicles.

Volvo has identified that the rear seatback lock striker(s) may not have been installed when the vehicle was manufactured.

PLEASE NOTE

The corrective action is to inspect the vehicle and verify that both rear seatback lock strikers are installed. If the rear seatback lock strikers are installed on the vehicle, no further action is necessary.

If one or both rear seatback strikers are missing, install them per the instructions below.

A total of 27 U.S. and 10 Canadian vehicles are eligible for this recall.

B. VEHICLES INVOLVED

NOTE: RETAILER MUST CONFIRM VEHICLE ELIGIBILITY PRIOR TO BEGINNING THE REPAIR FOR THIS RECALL.

Vehicle eligibility must be confirmed:

- Vehicle Inquiry – Vehicle Warranty where the message "Recall R89898 Rear Seatback Lock Strikers" will appear for eligible vehicles or check eligibility in TIE.

All vehicles should be checked for any incomplete recalls or service campaigns or service upgrades. All open Recall, Service Campaign or Service Action repairs should be completed. If you have any questions concerning this recall send them to recall@volvocars.com.

C. PARTS / PARTS RETURN

Please refer to Parts Bulletin 85-R89898.

PORT VEHICLES

No vehicles will be delivered from the ports without having this recall performed.

All vehicles must be checked for any incomplete recalls or service campaigns or service upgrades prior to delivery.

D. OWNER NOTIFICATION

Volvo Customer Care will contact the vehicle owners and will assist with arranging appointments with the selling retailer.

E. VEHICLES in RETAILER INVENTORY

It is a violation of federal law for a retailer to deliver any new Volvo that is eligible for a recall.

Retailers are advised to check all vehicles in inventory for recall eligibility and repair immediately.

Violation of this requirement by a retailer could result in a civil penalty of up to \$21,000 per vehicle. Correct all vehicles in your new vehicle inventory before delivery.

F. RETAILER RESPONSIBILITY

All vehicles qualifying for this recall must be repaired prior to a customer taking possession of the vehicle.

G. CAMPAIGN REIMBURSEMENT PROCEDURES

Recall R89898 claims should be submitted using the LONG FORM application only.

H. TECHNICIAN COMPETENCY REQUIREMENT

The technician competency requirement for this campaign repair is: Level 1 - Quality Tech.

I. RETAILER ALLOWANCE (LONG FORM APPLICATION)

Claim Type: R89898

Cause Code: 02

CSC Code: XW

Main OP: 99400

Failed Part: 31447982

INSPECTION

Operation Number	Repair Description	Qty	Labor Time
99400	Inspect Both Rear Lock Strikers	1	0.1

INSTALLATION IF NEEDED

Operation Number	Repair Description	Qty	Labor Time
97613	Install Rear Lock Striker(s)	1	0.7



Volvo Car Customer Service

QB Instruction VCC-513520-1

Title	Backrest folding lock	Page	1 (10)
Action	Installation	Operation number:	99400-2 97613-2

Issue	Date	Reason
1	2018-08	First issue

Affected vehicles

Model year	Model
2019	XC40

Materials

Materials	Qty.	Part No.	Notes
Flange nut	4.0	999127	
Lock brace	2.0	31447982	

Orientation view

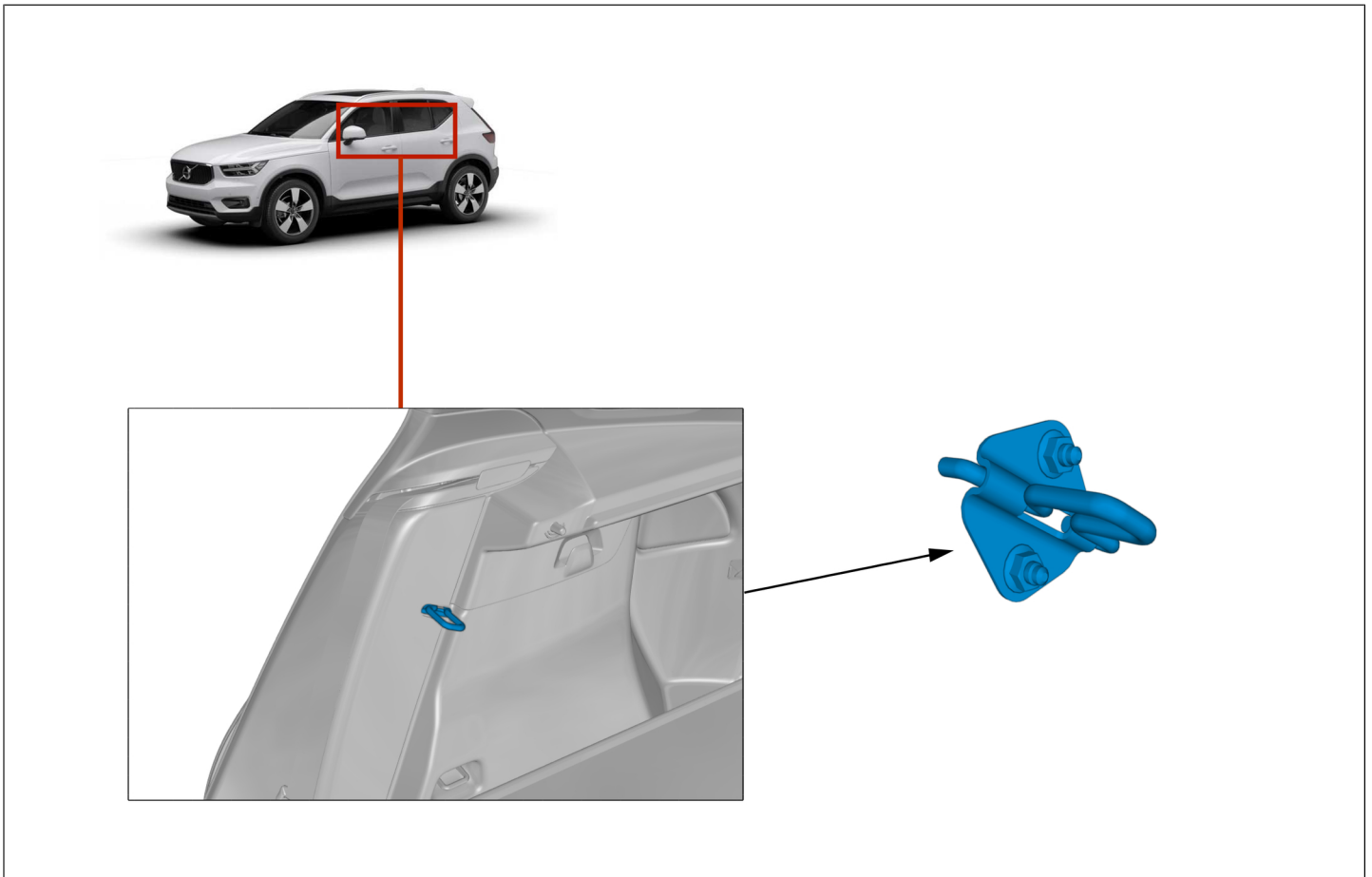

Color symbols

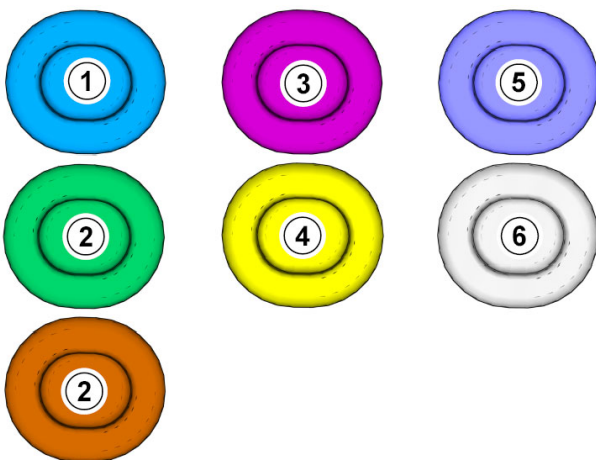

Note! This colour chart displays (in colour print and electronic version) the importance of the different colours used in the images of the method steps.

- 1 . Used for focused component, the component with which you will do something.
- 2 . Used as extra colors when you need to show or differentiate additional parts.
- 3 . Used for attachments that are to be removed/installed. May be screws, clips, connectors, etc.
- 4 . Used when the component is not fully removed from the vehicle but only hung to the side.
- 5 . Used for standard tools and special tools.
- 6 . Used as background color for vehicle components.

Check

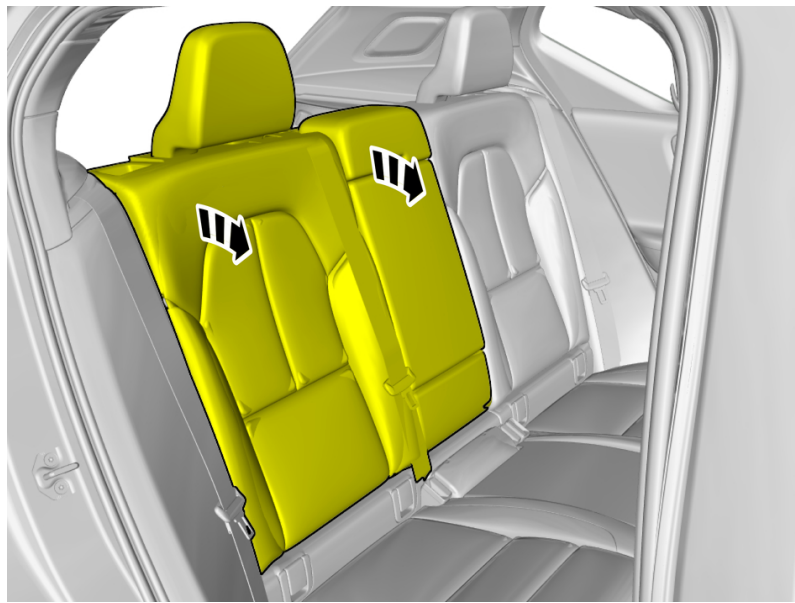

Fold marked part to one side.
Repeat on the other side.

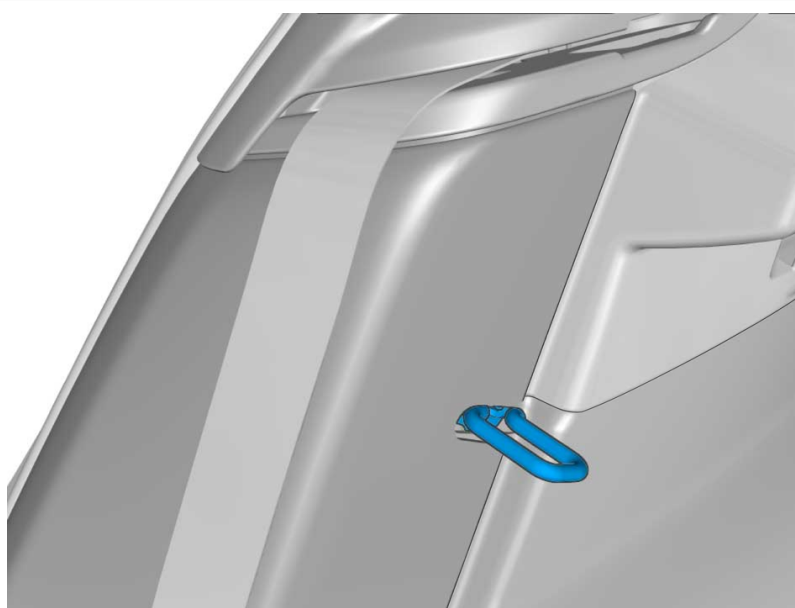

The graphic shows the correct design.
On both sides.

Removal



Fold marked part to one side.

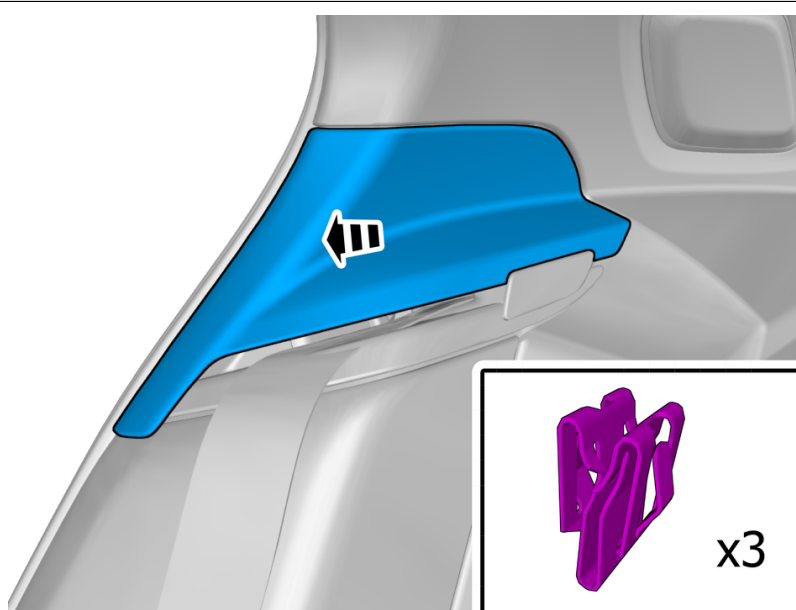

Remove the marked part.
Use hands only.

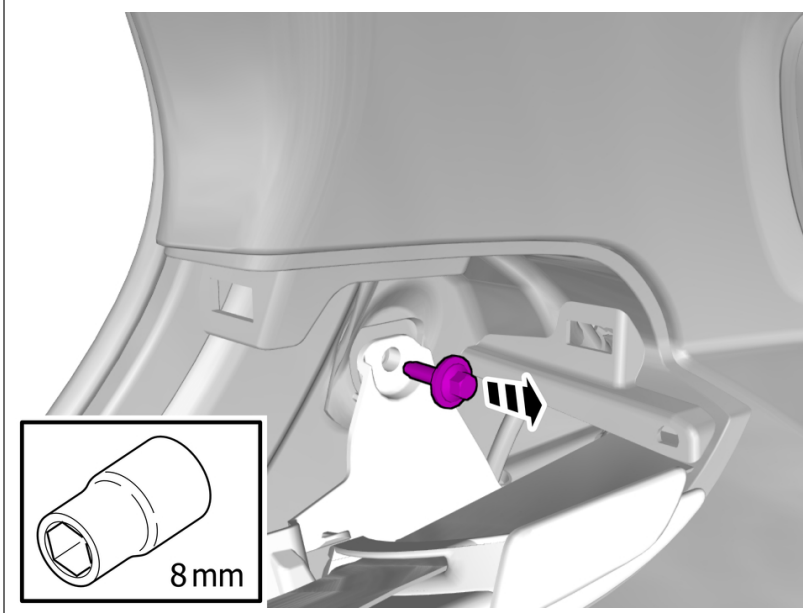

Remove the screw.

Torque:

Seat belt guide, to Bracket , 4.5 Nm

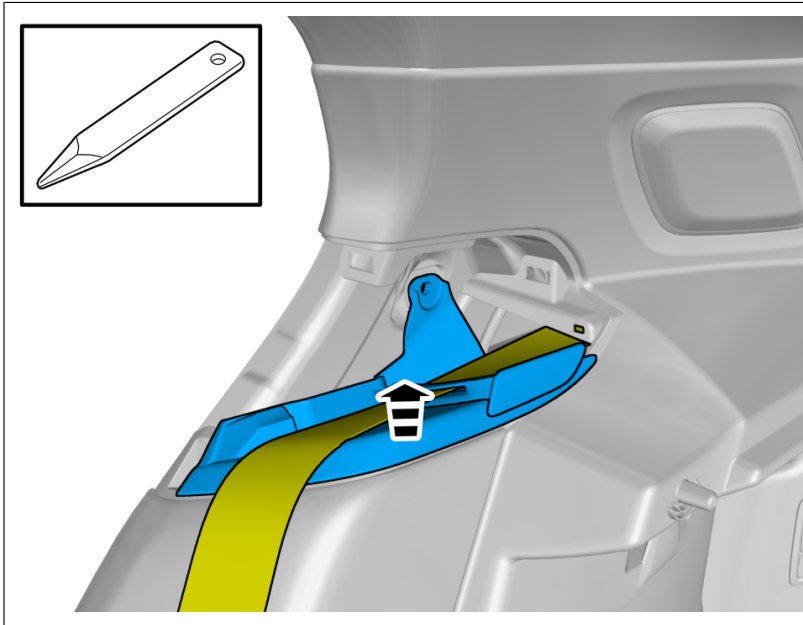

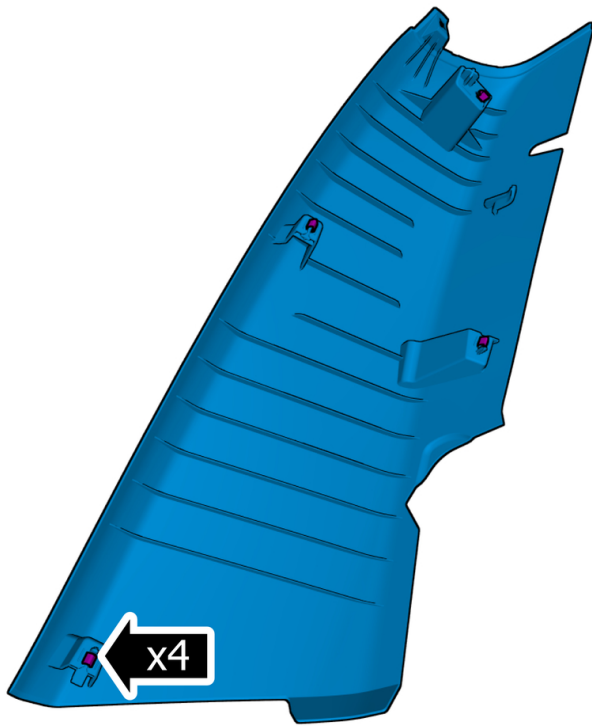

Note! The graphic shows the back of the component before removal.

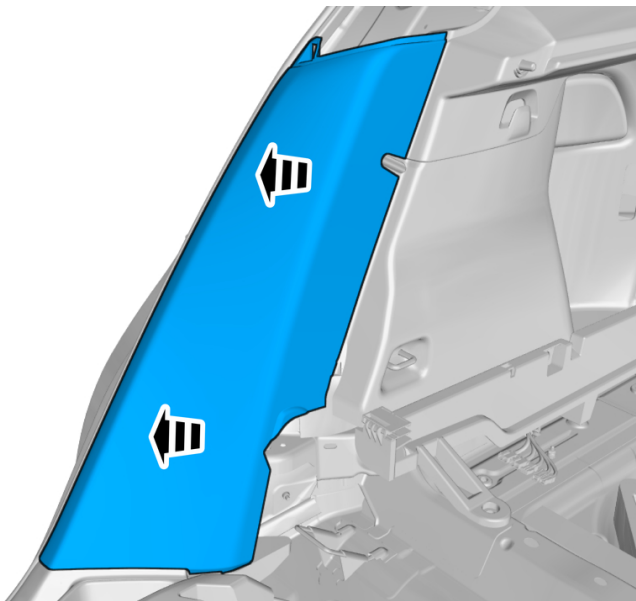

Remove the marked part.
Use hands only.

Open the tailgate.



Loosen the marked detail.
Repeat on the other side.

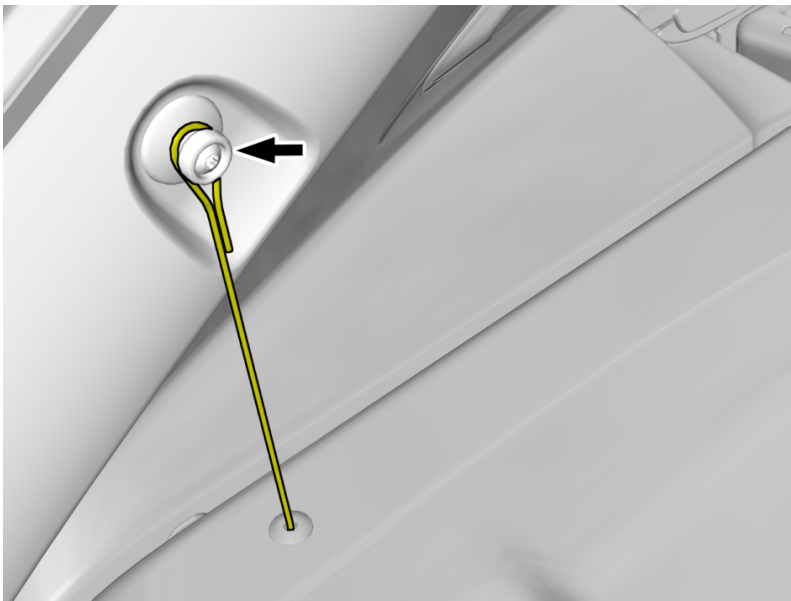

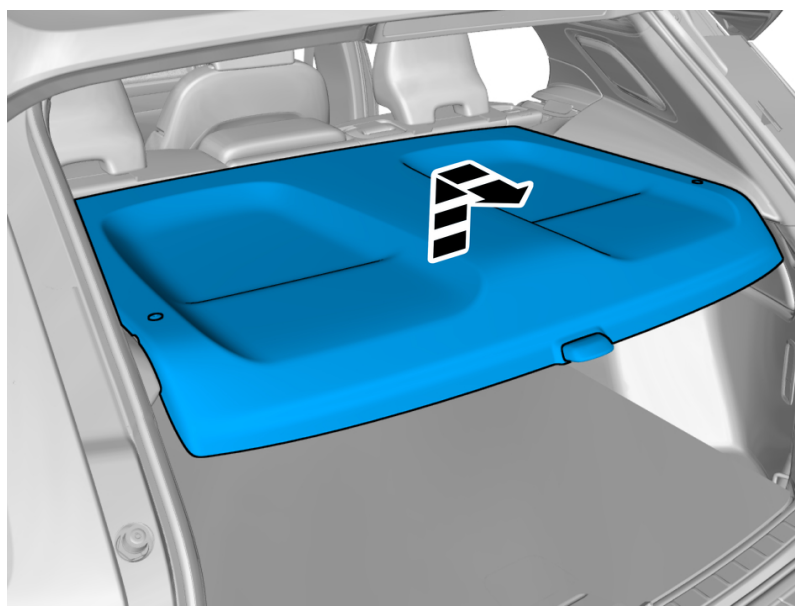

Remove the marked part.

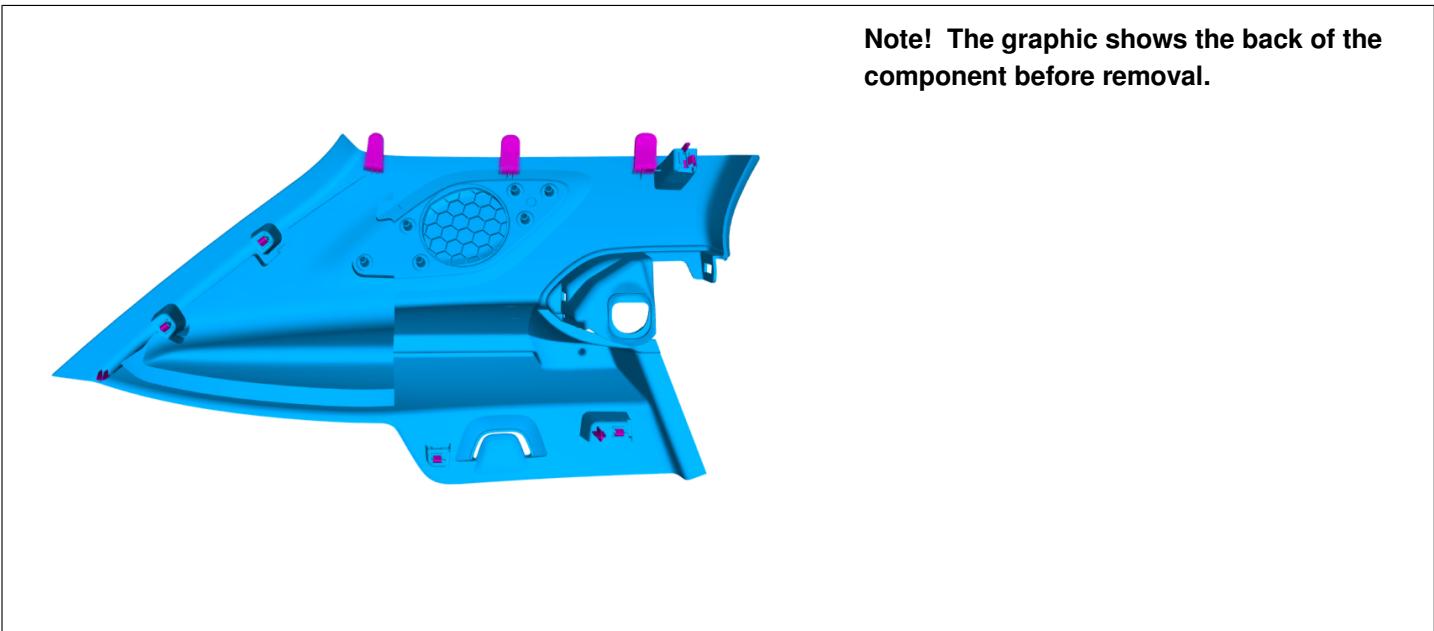

Note! The graphic shows the back of the component before removal.

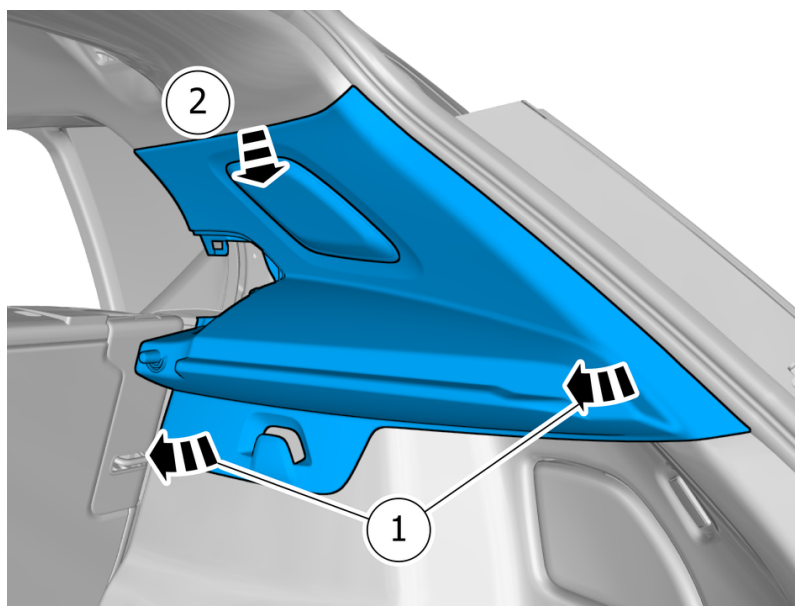

Remove the marked part.
Use hands only.

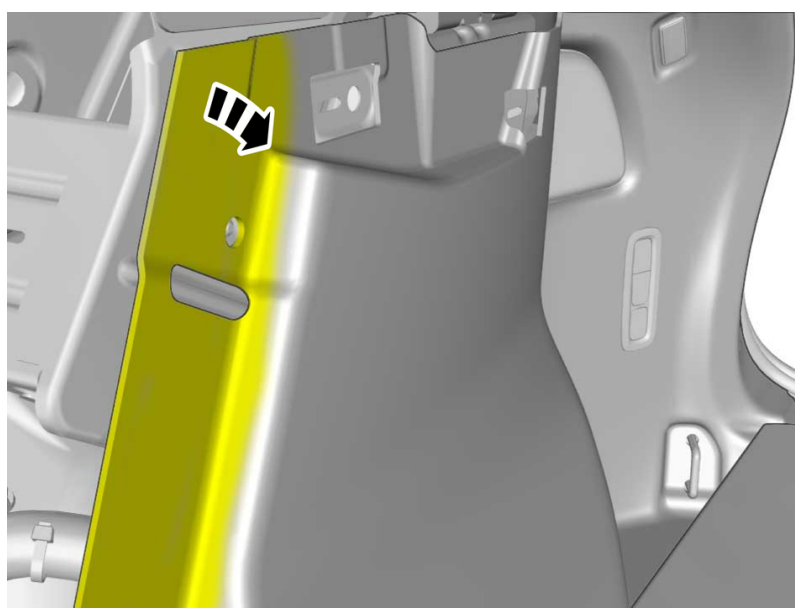

Fold marked part to one side.

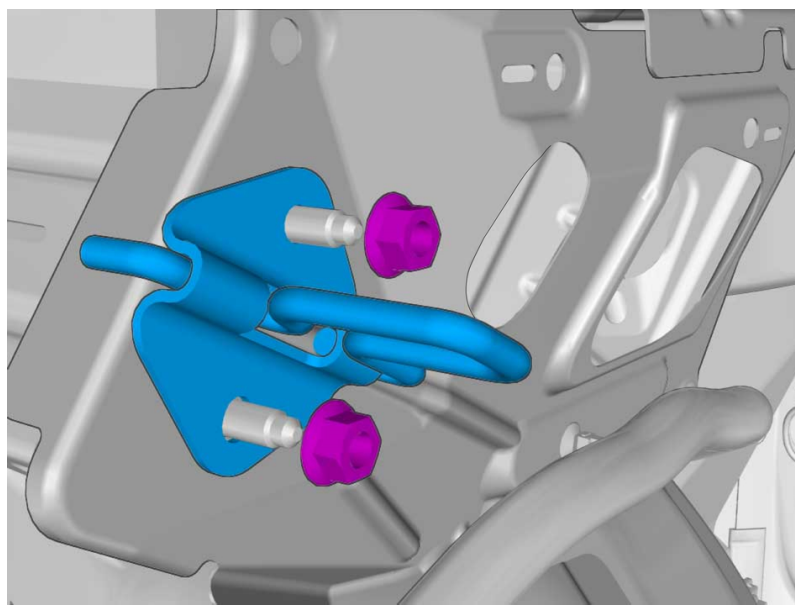
Installation

Install the marked component.
Install the nuts

Torque:

M10 , 50 Nm

Repeat all method steps for the other side.

To install, reverse the removal procedure.

PARTS BULLETIN

Subject: Recall R89898: Rear Seatback Lock Strikers	Group: 85	No: R89898
MY 2019 XC40	Market: US & CANADA	
		Date: 8/15/18

Reference Bulletin QB R89898

Volvo Car USA LLC and Volvo Car Canada LTD (Volvo) on behalf of Volvo Car Group has decided to launch Recall R89898 on a **limited** number of model year 2019 XC40 vehicles.

Volvo has identified that the rear seatback lock striker(s) may not have been installed when the vehicle was manufactured.

PLEASE NOTE

The corrective action is to inspect the vehicle and verify that both rear seatback lock strikers are installed. If the seatback lock strikers are installed on the vehicle, no further action is necessary.

If one or both rear seatback strikers are missing, install them per the instructions below.

A total of 27 U.S. and 10 Canadian vehicles are eligible for this recall.

The following part numbers apply:

Part Number	Description	Qty
31447982	Lock brace (striker)	1 (each side)
999127	Flange nut	2 (each side)

IMPORTANT

This recall involves a very limited number of vehicles.

Please order only after you have verified that you have a vehicle that requires these parts.