



# Technical Journal

TITLE:

**Center console side pocket, comes loose**

<b>REF NO:</b> TJ 33682.1.0	<b>ISSUING DEPARTMENT:</b> Technical Service	<b>CAR MARKET:</b> United States and Canada	
<b>PARTNER:</b> 3 US 7510 Volvo Car USA		<b>ISSUE DATE:</b> 2018-08-23	<b>STATUS DATE:</b> 2018-08-28
<b>FUNC GROUP:</b> 8552	<b>FUNC DESC:</b> Floor upholstery (firewall upholstery)	Page 1 of 7	

“Right first time in Time”

## Attachment

File Name	File Size
TJ 33682.pdf	1.7819 MB

## Vehicle Type

Type	Eng	Eng Desc	Sales	Body	Gear	Steer	Model Year	Plant	Chassis range	Struc Week Range
536							2019-2019		0000329-0070570	201746-201832

## CSC Customer Symptom Codes

Code	Description
WM	Center console/Lid difficult to open/close or broken

## VST Operation Number

VST Operation Number	Description
98716-2	Front storage compartment, floor console

## DTC Diagnostic Trouble Codes

## Text

**DESCRIPTION:**

If the center console pocket comes loose, see Service.

**SERVICE:**

Replace with a new pocket, p/n 32226476. Remove any tape or tape residue from the console. Do not apply any new tape. Follow attached instruction.

**VEHICLE REPORT:**

Yes, please submit a Vehicle Report if the service solution described in this TJ has no effect. Use concern area "Vehicle Report" and sub concern area "Support not needed", use function group 8552.

**To view TJ attachment continue to next page. This TJ has one attachment.**



## Volvo Car Customer Service

TJ Instruction VCC-513407-1

<b>Title</b>	Front storage compartment, floor console	<b>Page</b>	1 ( 5 )
<b>Action</b>	Product fix	<b>Operation number:</b>	98716-2

<b>Issue</b>	<b>Date</b>	<b>Reason</b>
1	2018-07	First issue

### Affected vehicles

<b>Model year</b>	<b>Model</b>
2019	XC40

### Equipment

<b>Designation</b>	<b>Part No.</b>
Interior trim remover	

## Orientation view

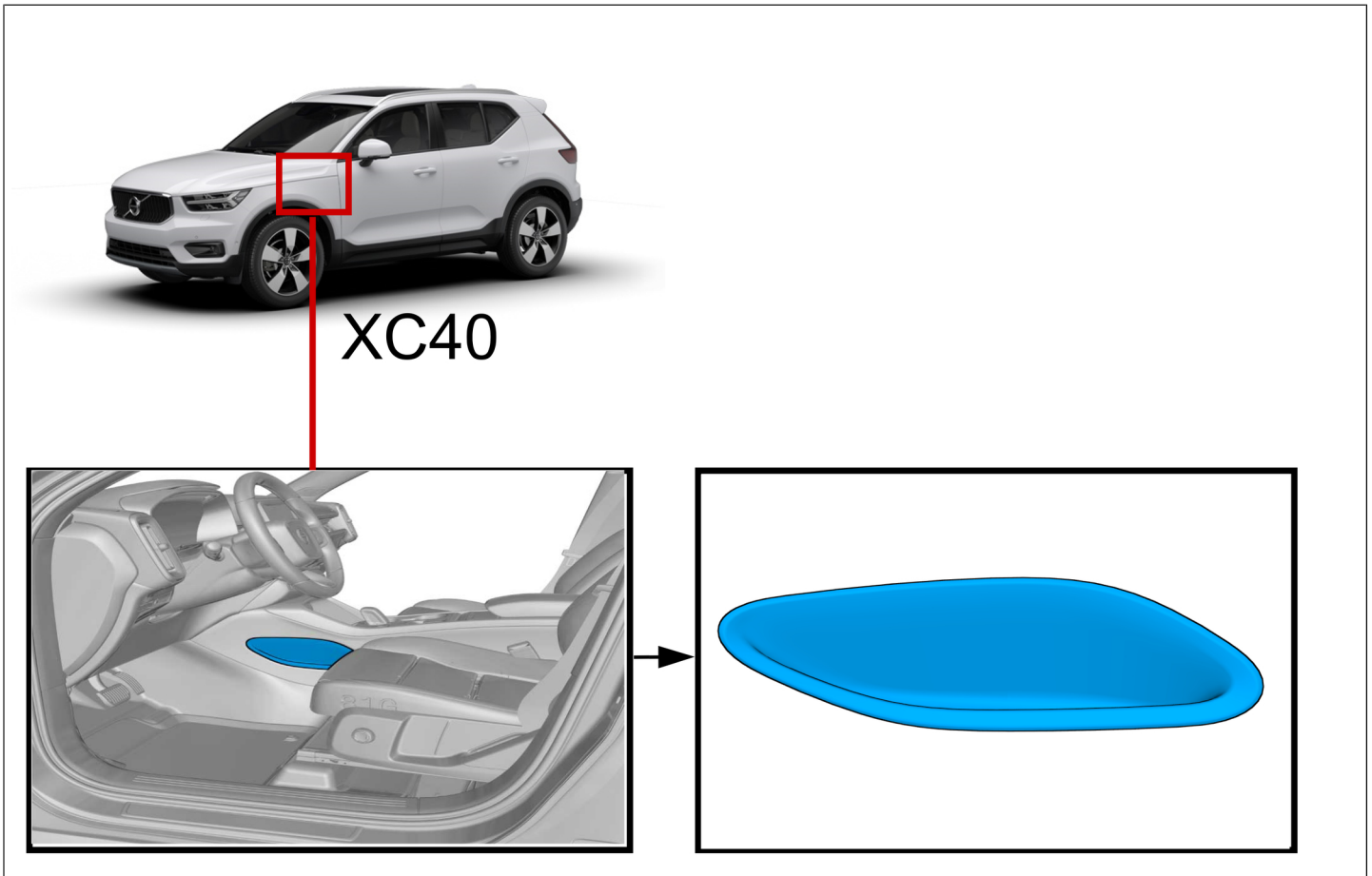

## Color symbols

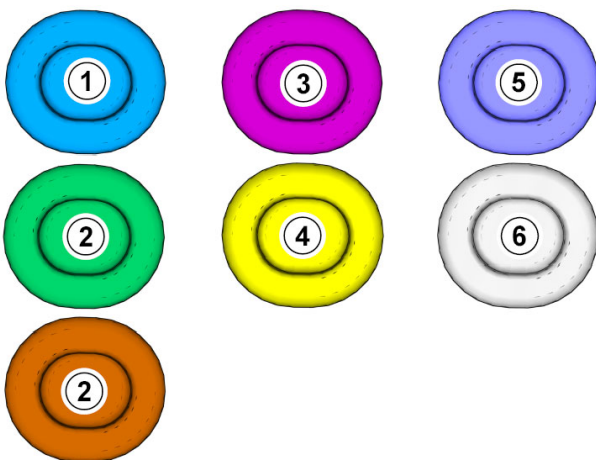

**Note! This colour chart displays (in colour print and electronic version) the importance of the different colours used in the images of the method steps.**

- 1 . Used for focused component, the component with which you will do something.
- 2 . Used as extra colors when you need to show or differentiate additional parts.
- 3 . Used for attachments that are to be removed/installed. May be screws, clips, connectors, etc.
- 4 . Used when the component is not fully removed from the vehicle but only hung to the side.
- 5 . Used for standard tools and special tools.
- 6 . Used as background color for vehicle components.

Removal

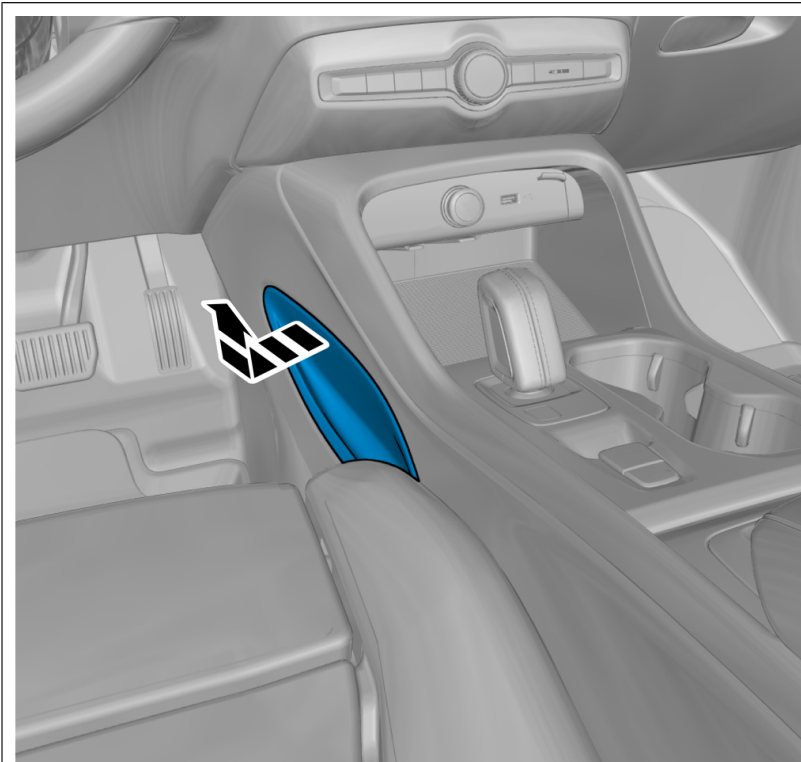
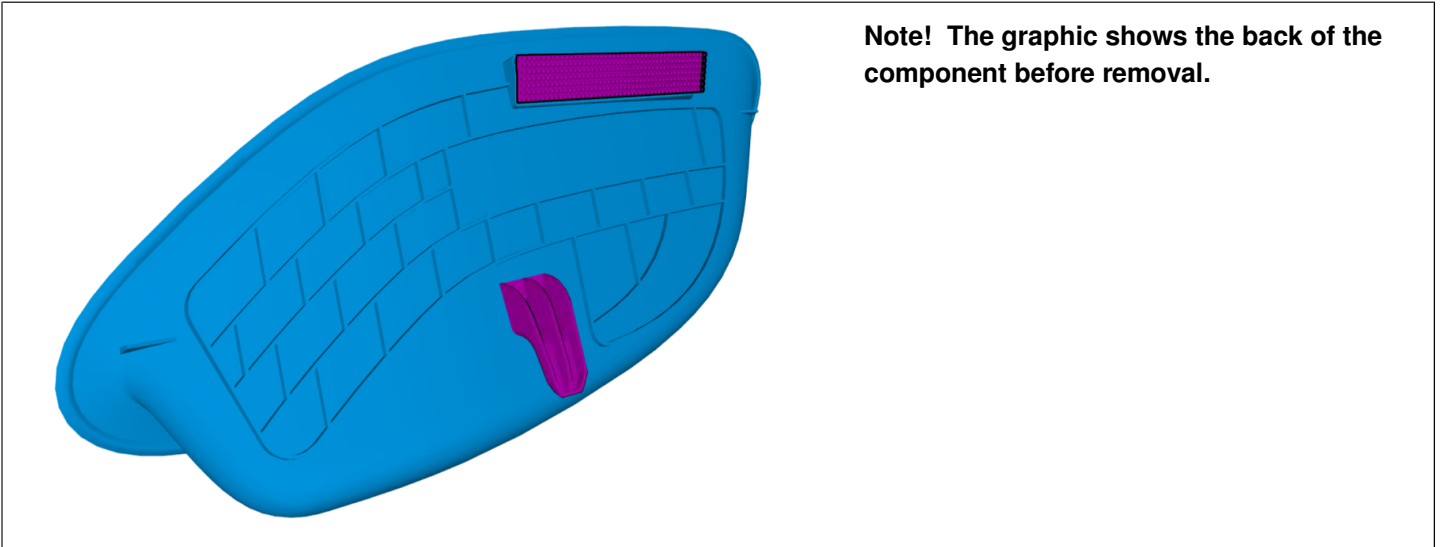

**Use:** Interior trim remover

Remove the part carefully

Remove the marked part.

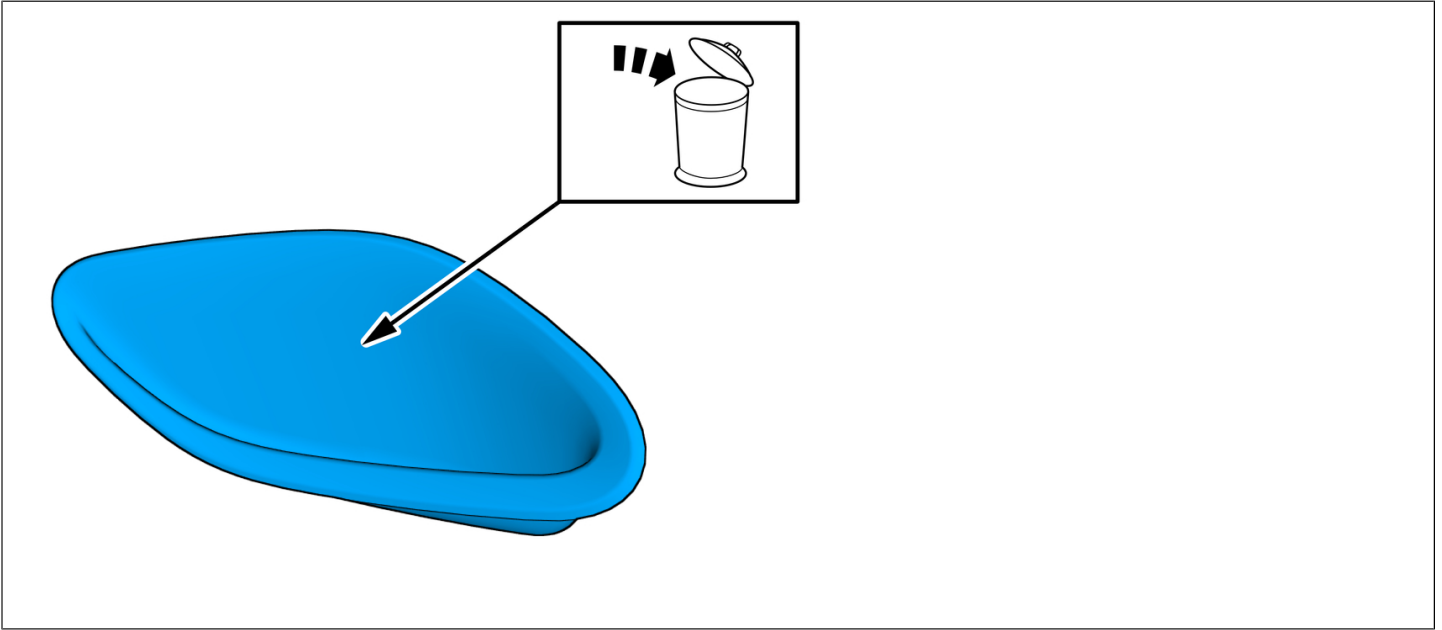

Removal of tape residue

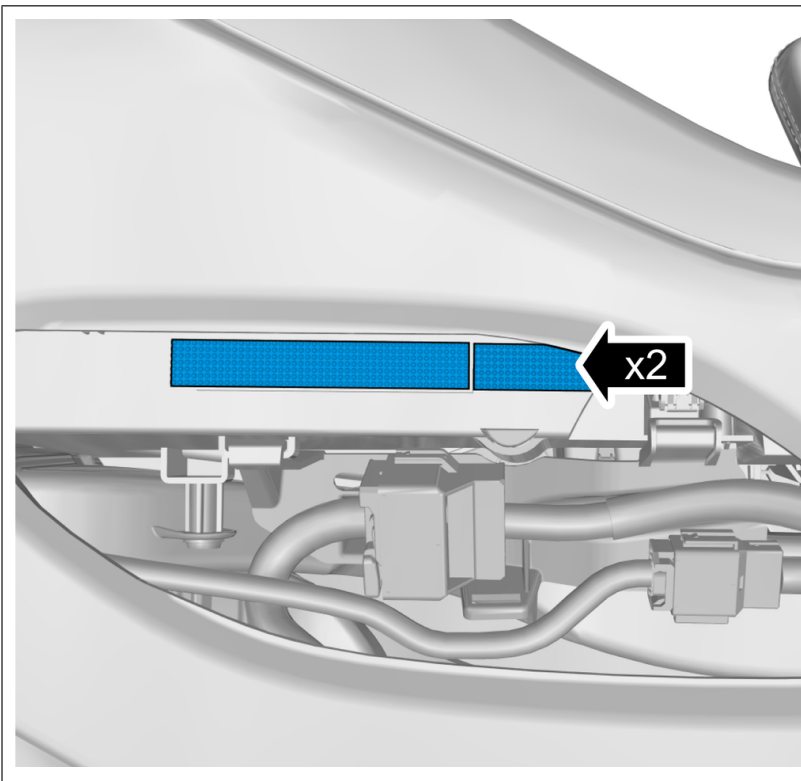

Remove any tape or tape residue.

### Installation

**Note!** Make sure that a new component is installed.

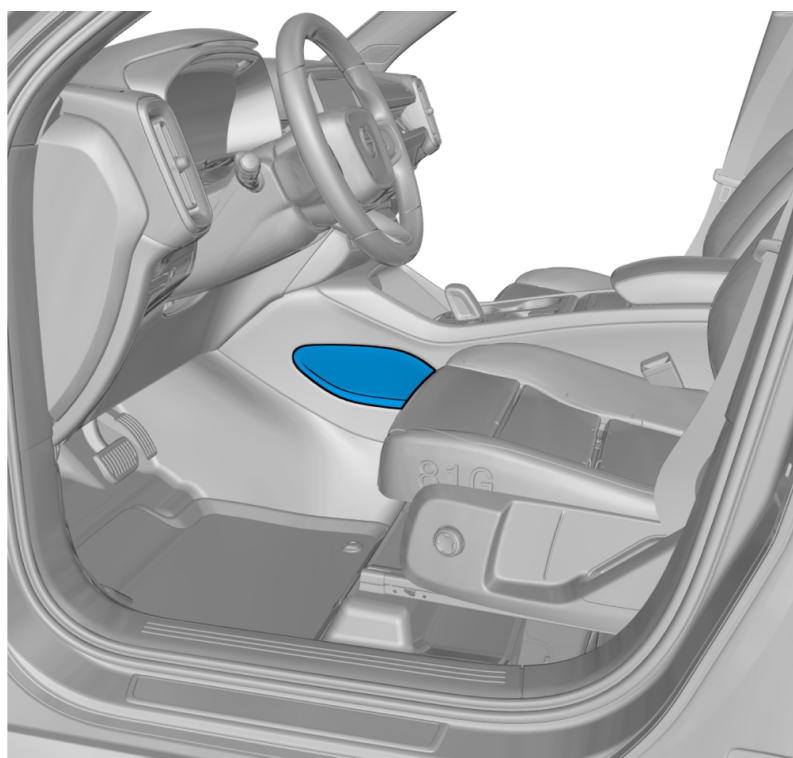
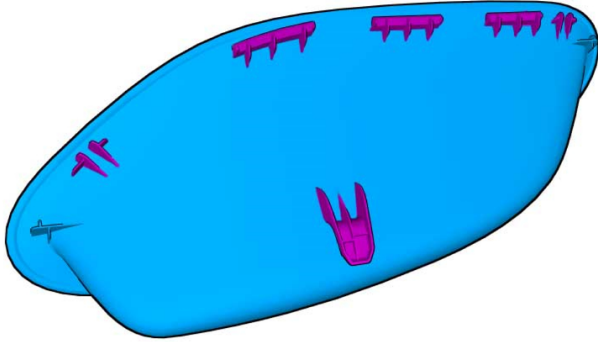

Install the marked component.