



# Technical Journal

TITLE:

**Floor hatch compartment, hard to open or handle too loose**

|  |   |  |                                   |
|--|---|--|-----------------------------------|
| <b>REF NO:</b><br>TJ 33284.1.0             | <b>ISSUING DEPARTMENT:</b><br>Technical Service | <b>CAR MARKET:</b><br>United States and Canada |                                   |
| <b>PARTNER:</b><br>3 US 7510 Volvo Car USA |   | <b>ISSUE DATE:</b><br>2018-07-12               | <b>STATUS DATE:</b><br>2018-07-17 |
| <b>FUNC GROUP:</b><br>8516                 | <b>FUNC DESC:</b><br>Upholstery for rear shelf  | Page 1 of 9                                    |                                   |

“Right first time in Time”

## Attachment

| File Name                  | File Size |
|----------------------------|-----------|
| TJI-513383-2_1_1_en-US.pdf | 1.7329 MB |

## Vehicle Type

| Type | Eng | Eng Desc | Sales | Body | Gear | Steer | Model Year | Plant | Chassis range   | Struc Week Range |
|------|-----|----------|-------|------|------|-------|------------|-------|-----------------|------------------|
| 256  |     |          |       |      |      |       | 2016-9999  |       | 0000561-0999999 | 201505-999912    |

## CSC Customer Symptom Codes

| Code | Description                             |
|------|---|
| WF   | Cargo area cover/Does not work properly |

## VST Operation Number

| VST Operation Number | Description                              |
|----------------------|--|
| 98715-2              | Handle floor hatch adjust acc.to TJ33284 |

## DTC Diagnostic Trouble Codes

## Text

**DESCRIPTION:**

If the luggage compartment hatch is hard to open or if the handle feels loose, follow instructions under Service.

**SERVICE:**

Follow attached instruction.

**VEHICLE REPORT:**

Yes, please submit a Vehicle Report if the service solution described in this TJ has no effect. Use concern area "Vehicle Report" and sub concern area "Support not needed", use function group 8516.

**To view TJ attachment continue to next page. This TJ has one attachment.**



## Volvo Car Customer Service

TJ Instruction VCC-513383-2

|               |                    |                          |         |
|---------------|--------------------|--------------------------|---------|
| <b>Title</b>  | Floor hatch handle | <b>Page</b>              | 1 ( 7 ) |
| <b>Action</b> | Product fix        | <b>Operation number:</b> | 98715-2 |

| <b>Issue</b> | <b>Date</b> | <b>Reason</b> |
|--------------|-------------|---------------|
| 1            | 2018-07     | First issue   |

### Affected vehicles

| <b>Model year</b>         | <b>Model</b> |
|---------------------------|--------------|
| 2016, 2017,<br>2018, 2019 | XC90 (16-)   |

### Equipment

| <b>Designation</b>    | <b>Part No.</b> |
|-----------------------|-----------------|
| Interior trim remover |                 |

## Orientation view

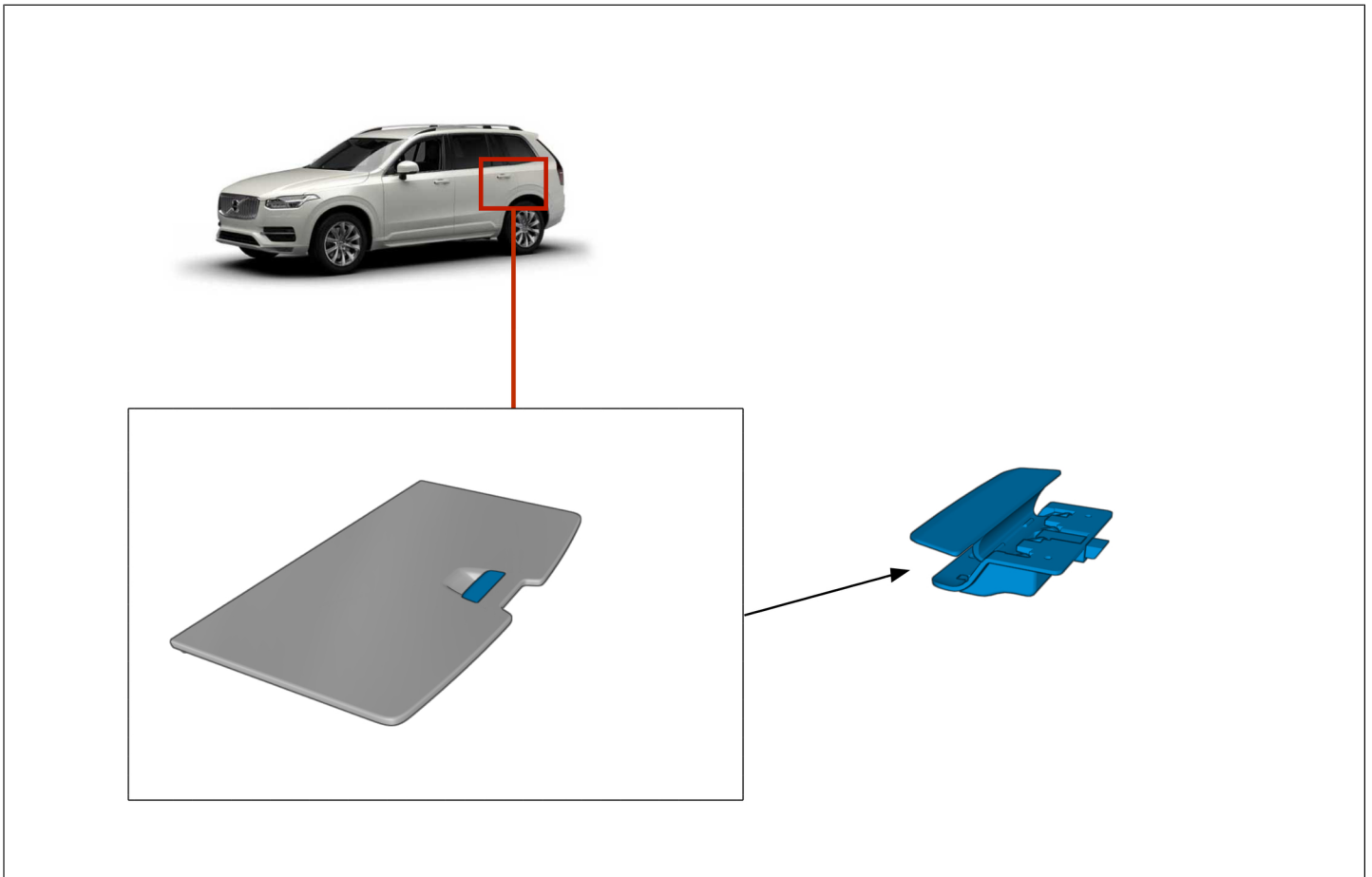

## Color symbols

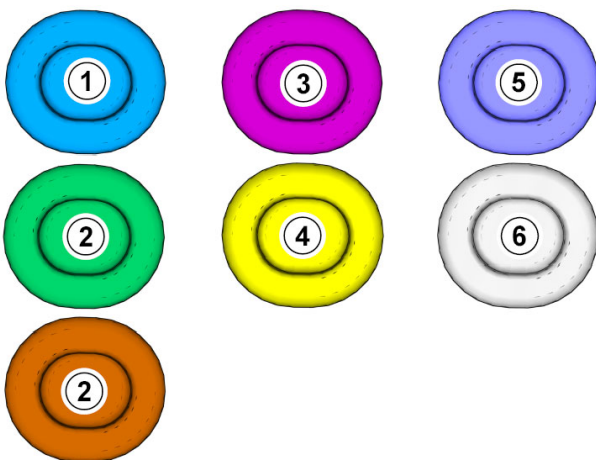

**Note! This colour chart displays (in colour print and electronic version) the importance of the different colours used in the images of the method steps.**

- 1 . Used for focused component, the component with which you will do something.
- 2 . Used as extra colors when you need to show or differentiate additional parts.
- 3 . Used for attachments that are to be removed/installed. May be screws, clips, connectors, etc.
- 4 . Used when the component is not fully removed from the vehicle but only hung to the side.
- 5 . Used for standard tools and special tools.
- 6 . Used as background color for vehicle components.

**Preparation**

Open the tailgate.

**Removal**

Remove the marked part.

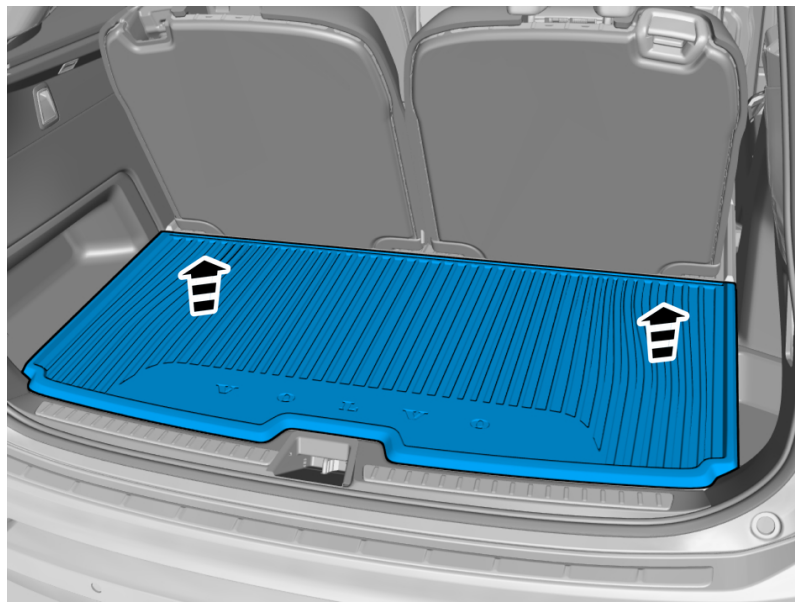

Remove the marked part.

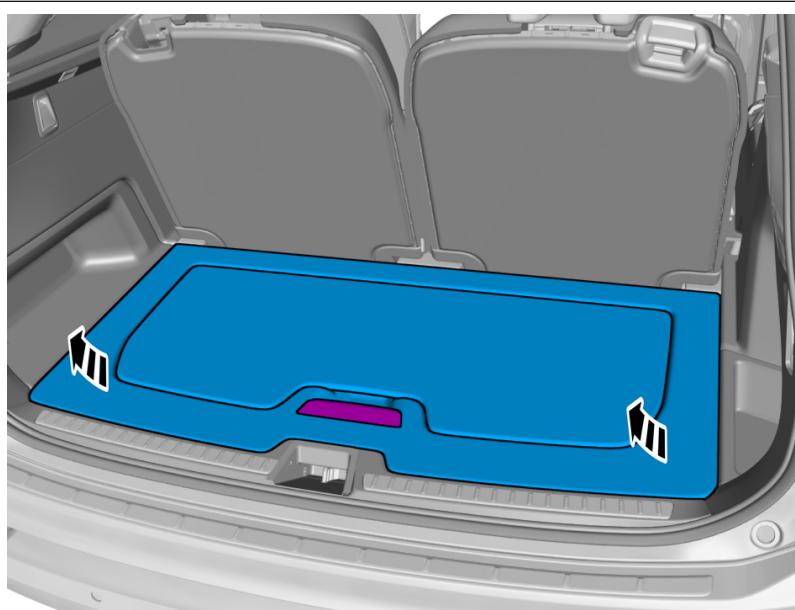

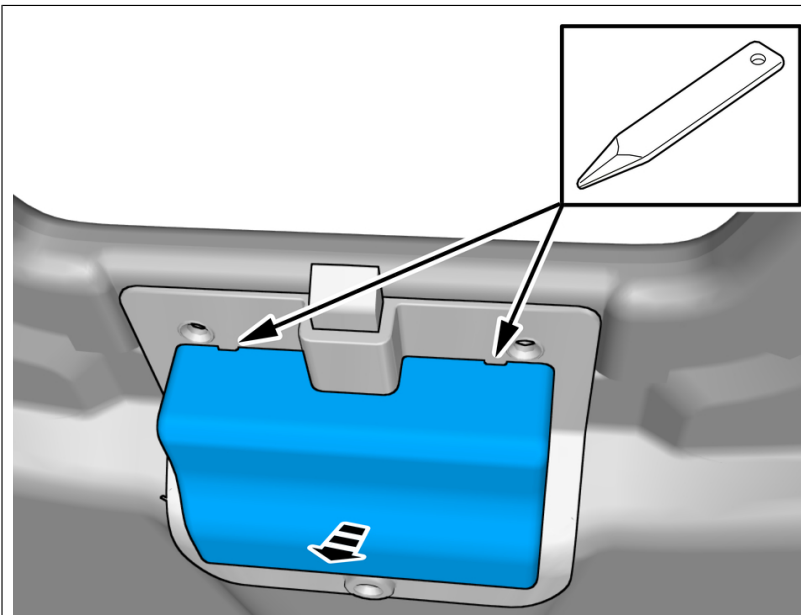
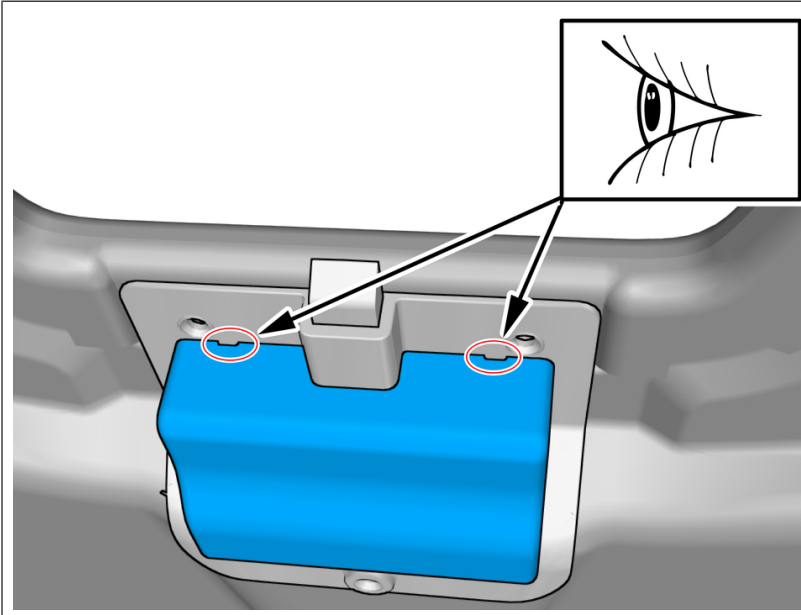

**Use:** Interior trim remover  
Remove the part carefully  
Remove the marked part.

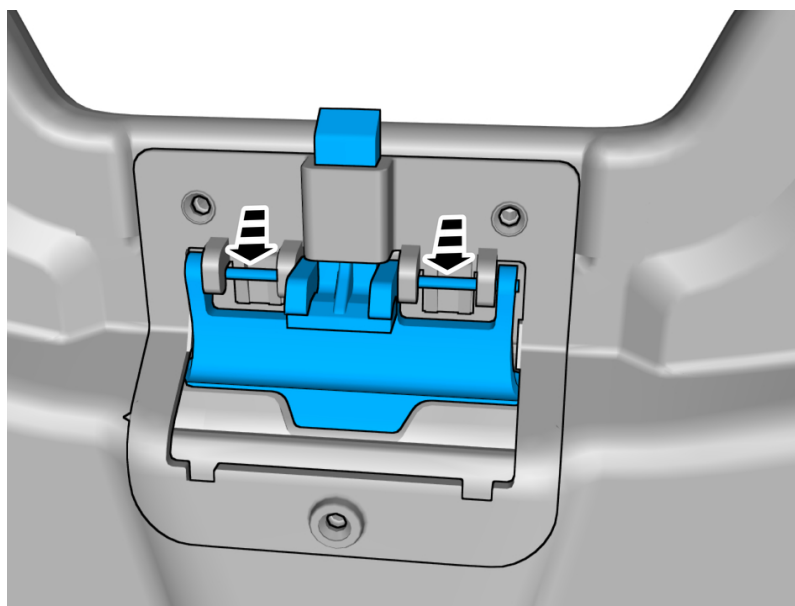

**Caution! Make sure that the component is positioned correctly.**

Remove the part carefully

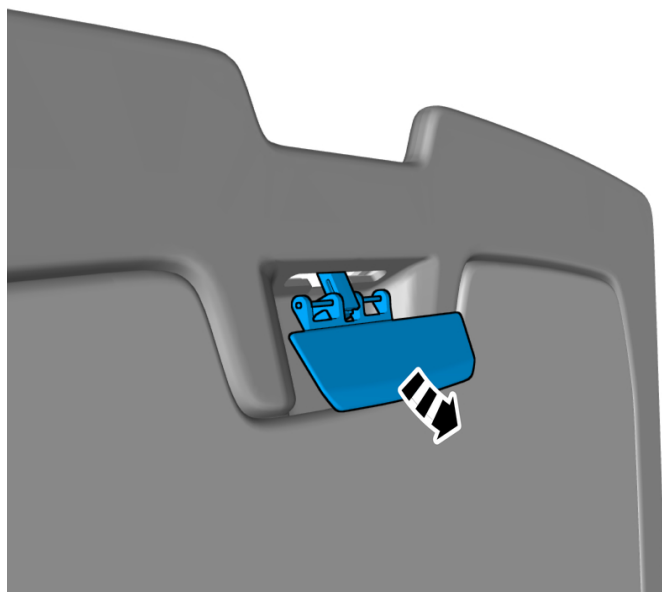

Remove the marked part.

**Caution! Make sure that the component is positioned correctly.**

Remove the part carefully

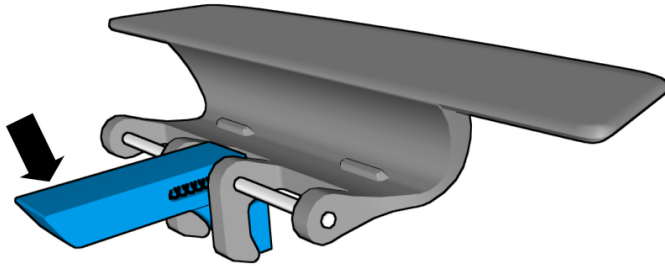

Remove the marked part.

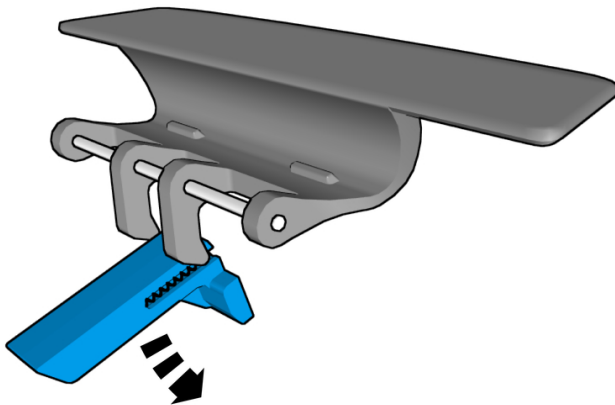



**Adjustment**

**Note! Note the position.**

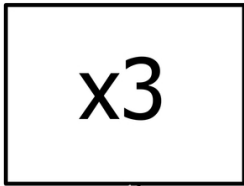
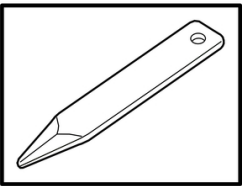
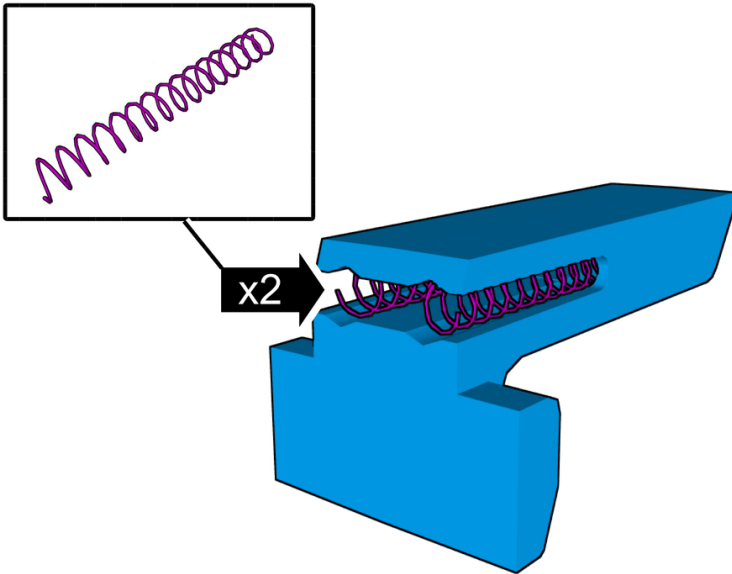

**Use:** Interior trim remover  
Repeat the number of times stated

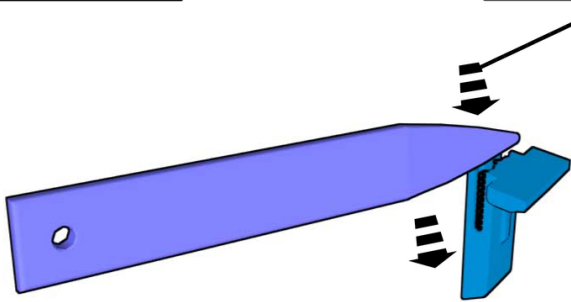

**Installation**

To install, reverse the removal procedure.

**Check**

Check for correct operation.