



Technical Service Bulletin

46 Q7 MY18 Squeal from front brakes

46 18 96 2050737/5 September 4, 2018. Supersedes Technical Service Bulletin Group 46 number 18-93 dated June 8, 2018 for reasons listed below.

Model(s)	Year	VIN Range	Vehicle-Specific Equipment
Q7	2018	000001 - 039706	With disc brakes in front

Condition

REVISION HISTORY		
Revision	Date	Purpose
5	-	Revised <i>Warranty</i> (Updated TU) Revised <i>Required Parts and Tools</i> (Removed remark)
4	06/08/2018	Revised <i>Service</i> (Updated procedure) Revised <i>Required Parts and Tools</i> (Added part number)
3	05/07/2018	Revised header data (Updated VIN break)

Customer reports hearing a squeal noise (1.6 KHz) from the front brakes in the following conditions:

- Slow speeds, usually below 20 mph
- Usually in reverse
- Cold brakes
- Temperature and humidity conditions may vary



Technical Service Bulletin

Please review the audio/video example below:
<https://audi-external.kzoplatform.com:443/swf/player/359>.



Figure 1. QR Code for Supporting Video.



Note:

Frequencies can be identified with our Audi Frequency Analysis App, review TSB 2051095: *46 Audi frequency analysis* for further information.

Technical Background

Not applicable.

Production Solution

Not applicable.

Service

Replace front brake pads according to the instruction in Elsa at Repair Manual, *Chassis >> Brake System >> 46 Mechanical Components >> Front Brakes >> Brake Pads, Removing and Installing Steel Brakes*.

1. Identify the caliper casting lip of the installed caliper in the vehicle. There are two possibilities for the lip; large and small. (Figure 1).



Technical Service Bulletin

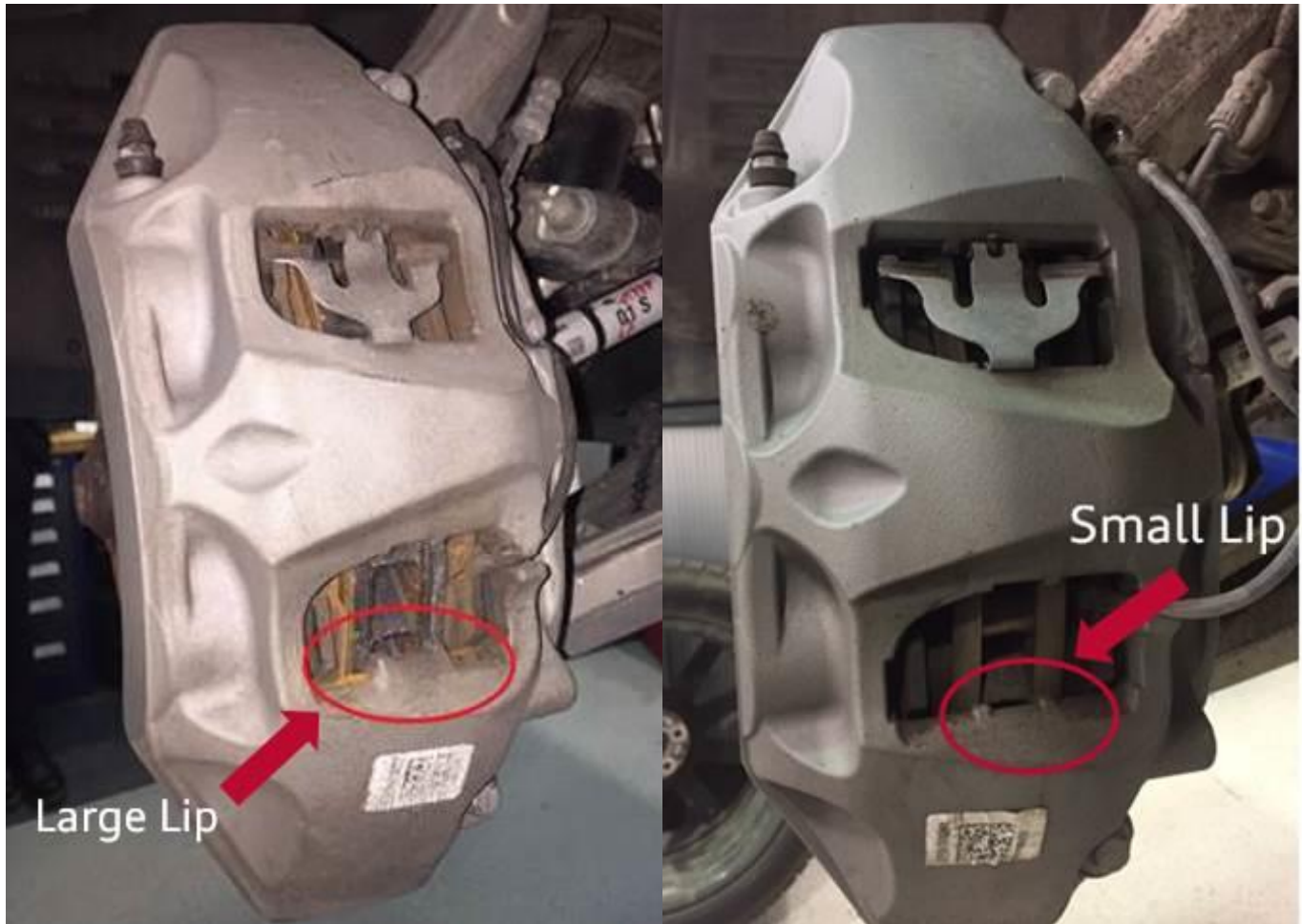

Figure 1. Caliper casting lip configurations.

2. Install one new lower spring in each caliper. Final configuration must have two springs per caliper (Figure 2). See available spring designs (Figure 3).
3. According to caliper casting, a specific type of spring must be assembled, as follows:

LARGE CASTING LIP >>> INSTALL SPRING 4M0 615 269 C
SMALL CASTING LIP >>> INSTALL SPRING 4M0 615 269 or 4M0 615 269 B



Technical Service Bulletin

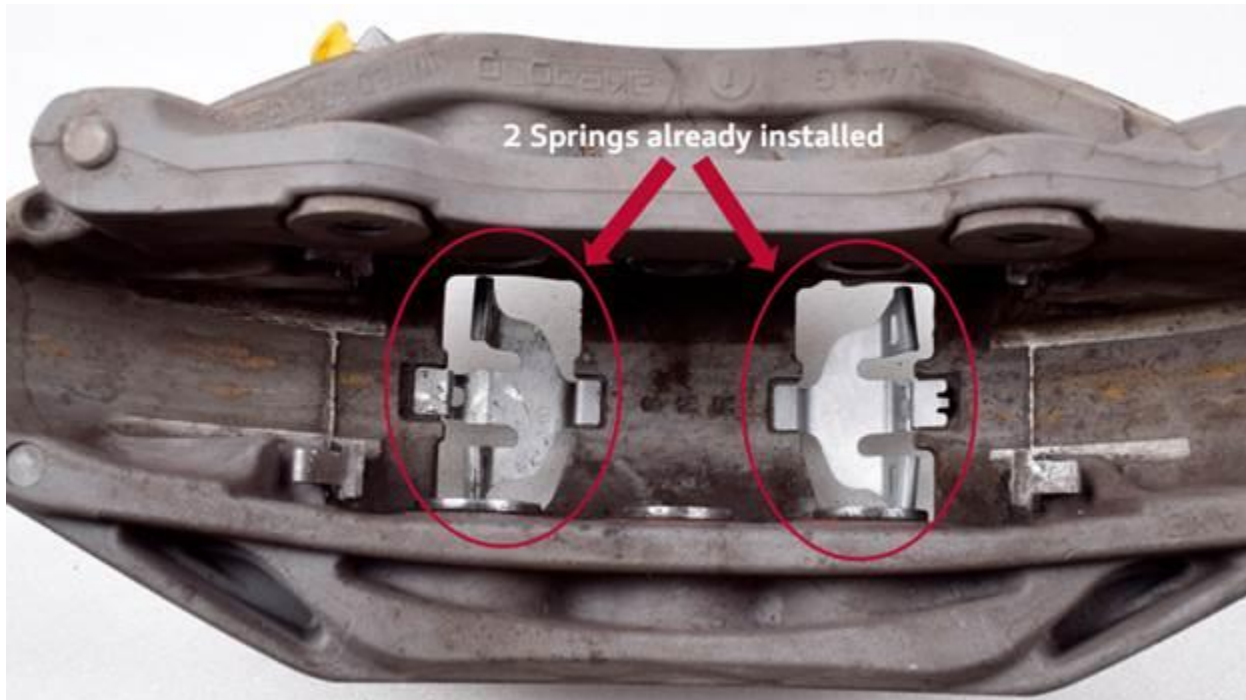

Figure 2. Spring configuration, after installation.

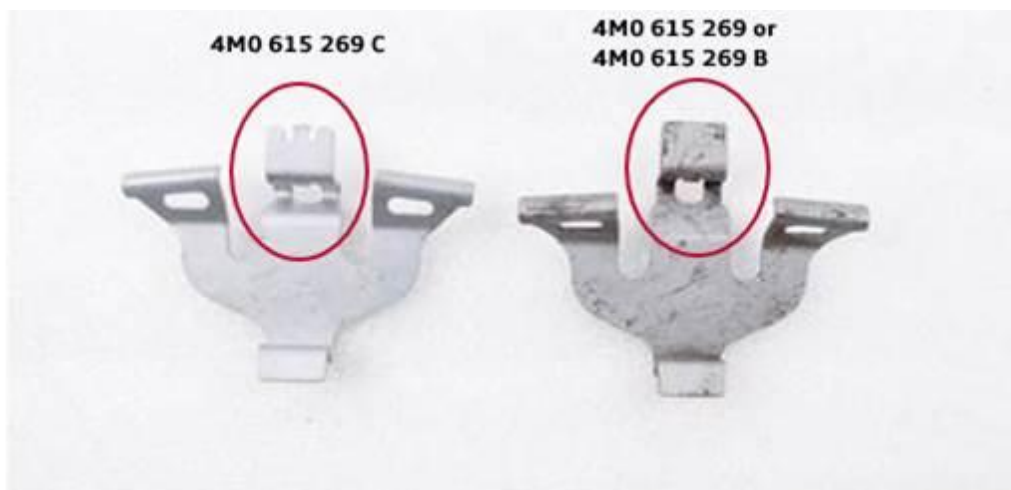

Figure 3. Spring designs.

4. It is mandatory to clean the contact surfaces (red marked with arrows) and coat with lithium grease (Figure 4). Also, coat the brake pad plate/guide pins and pad contact surfaces with lithium grease.



Technical Service Bulletin

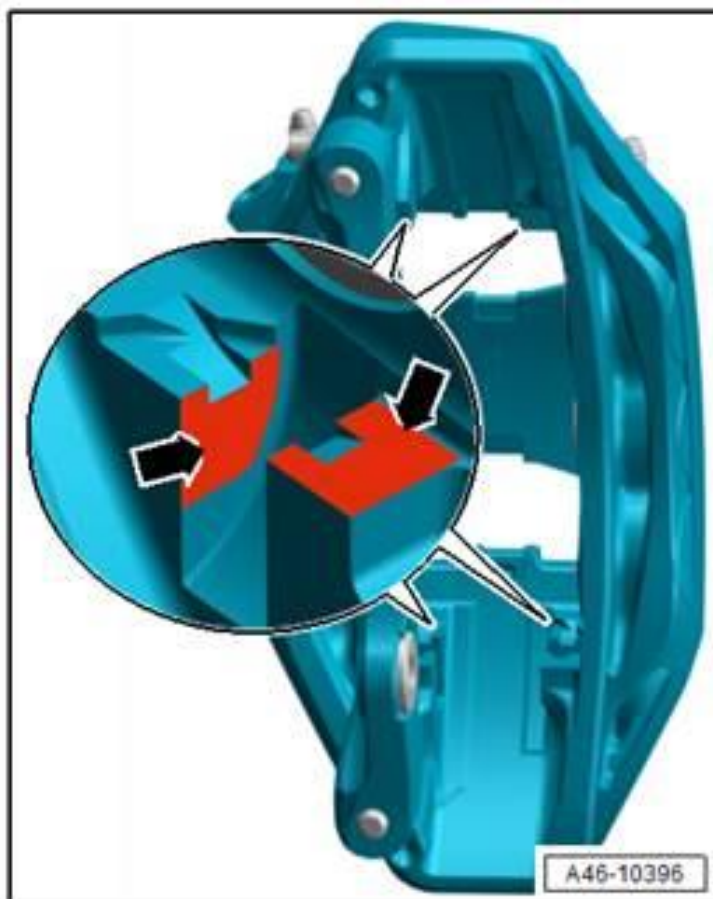

Figure 4. Clean contact surfaces and then coat with lithium grease.

5. It is mandatory to pay attention to the labeling on the brake pad (Figure 5). In installed position the arrow (1) on the backing plate must point upward (the pads should be installed with the arrows following the forward rotation of the wheel). Labeling (2) indicate correct assembly position (left outer/inner, right outer/inner).



Technical Service Bulletin

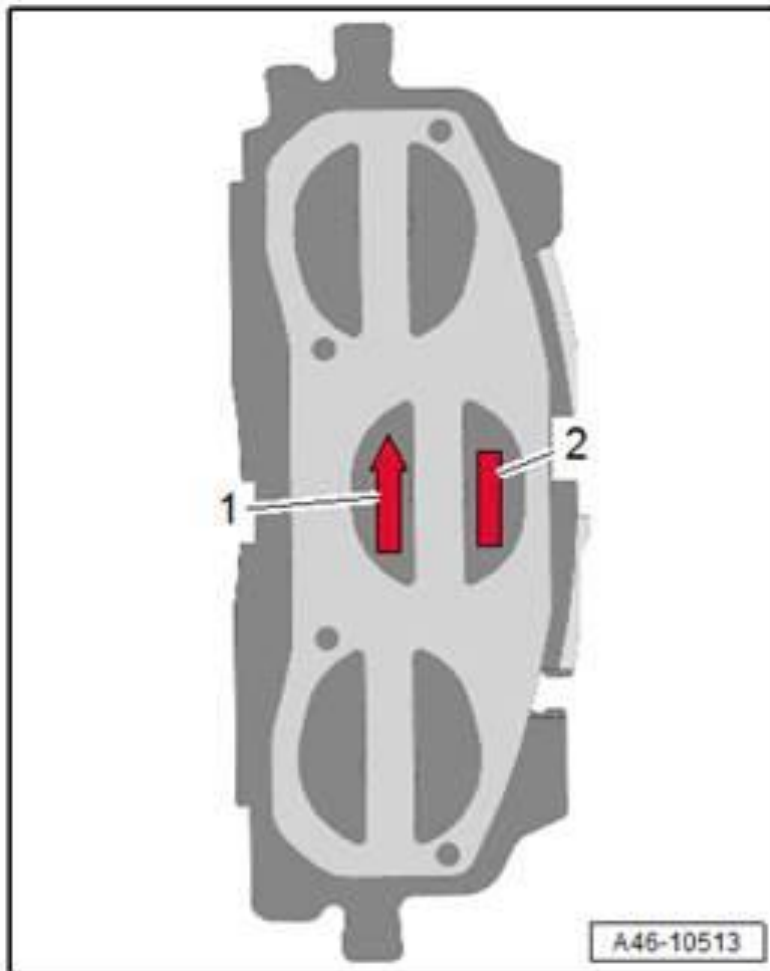

Figure 5. Correct installation positioning for the brake pad.

6. It is mandatory to replace all 4 brake pad intermediate plate per caliper – included in the brake pad box (Figure 6).



Technical Service Bulletin

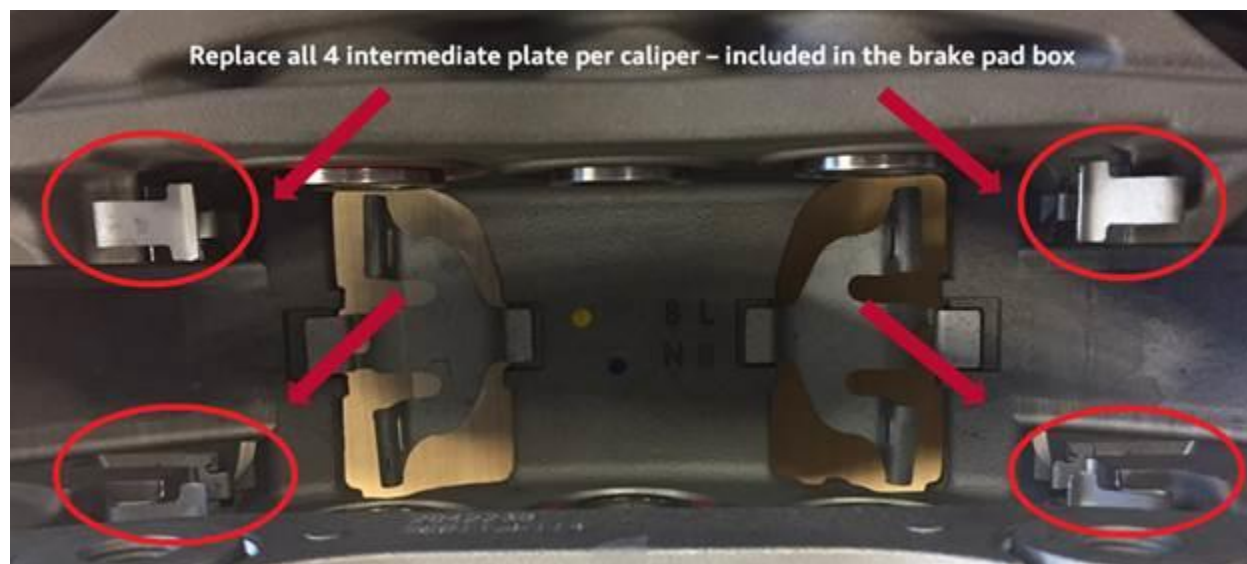

Figure 6. Replace all 4 intermediate plates.

7. Brake Embedding:

- a. Perform 10 stops from approximately 35 mph to 10 mph with medium brake application.
- b. Drive for approximately 2 minutes 40 mph without braking to allow the brakes to cool down.
- c. Repeat steps A and B if necessary.



Note:

- A. This bulletin does not apply if there is improper operation or misuse of the vehicle.
- B. Do not perform ABS stops as a way of embedding the brakes. Brake pads and discs may be permanently damaged if brakes are overheated prior to be proper embedded.
- C. Do not replace current springs already installed in the caliper. It is mandatory to install two springs per vehicle.



Tip: Rust/Corrosion build-up, grooves, or glazing on the braking surface of the brake disc may cause noise and must be considered when replacing brake pads (Also review TSB 2034181: *Brake noise analysis and handling*).



Technical Service Bulletin

Warranty

Claim Type:	<ul style="list-style-type: none"> • 110 up to 24 Months/24,000 Miles. • If vehicle is outside any warranty, this Technical Service Bulletin is informational only. 		
Service Number:	4636		
Damage Code:	0010		
Labor Operations:	Wheels remove + reinstall (front)	4405 2000	30 TU
	Brake pads front remove + reinstall	4636 2050	60 TU
Diagnostic Time:	GFF	No allowance	0 TU
	Road test prior to service procedure	0121 0002	10 TU
	Road test after service procedure	0121 0004	10 TU
Claim Comment:	As per TSB #2050737/5		

All warranty claims submitted for payment must be in accordance with the *Audi Warranty Policies and Procedures Manual*. Claims are subject to review or audit by Audi Warranty.

Required Parts and Tools

Part Number	Part Description	Quantity
4M0698151BD	Set of front brake pads	01
4M0615269 or 4M0615269B or 4M0615269C	 Note: Packaging may vary with 1 or 2 parts, according to the supplier.	02 springs per vehicle/repair
G052150A2	Lithium grease	0.1
See ETKA	Sender wire (pad wear indicator, replace only if damaged).	02
See ETKA	Fasteners, Bolts, Nuts and Screws as needed per the Repair Manual	See ETKA/ELSA



Technical Service Bulletin

Additional Information

The following Technical Service Bulletin(s) will be necessary to complete this procedure:

- TSB 2051095, *46 Audi frequency analysis*.
- TSB 2034181, *Brake noise analysis and handling*.

All parts and service references provided in this TSB (2050737) are subject to change and/or removal. Always check with your Parts Department and/or ETKA for the latest information and parts bulletins.

©2018 Audi of America, Inc. All rights reserved. Information contained in this document is based on the latest information available at the time of printing and is subject to the copyright and other intellectual property rights of Audi of America, Inc., its affiliated companies and its licensors. All rights are reserved to make changes at any time without notice. No part of this document may be reproduced, stored in a retrieval system, or transmitted in any form or by any means, electronic, mechanical, photocopying, recording, or otherwise, nor may these materials be modified or reposted to other sites without the prior expressed written permission of the publisher.