



SERVICE BULLETIN

Classification: AT16-001i	Reference: NTB16-110i	Date: July 6, 2018
------------------------------	--------------------------	-----------------------

2013-2017 ALTIMA AND 2014-2016 ROGUE; 4 CYLINDER WITH DTC P0776 AND/OR P0841 AND/OR JUDDER WITH P17F0 OR P17F1 STORED

This bulletin has been amended to add additional information under
If You Confirm on page 1, the Claims Information and to add part numbers to Table B.
No other changes have been made.

APPLIED VEHICLE: 2013-2017 Altima (L33) **with 4 cylinder only**
2014-2016 Rogue (T32)

APPLIED TRANSMISSION: CVT

IF YOU CONFIRM

The MIL is ON with DTC **P0776** (PC SOLENOID B – Pressure Control Solenoid “B” Performance/Stuck OFF) and/or DTC **P0841** (TRANSMISSION FLUID PRESSURE SEN/SW A).

- P1715 (INPUT SPEED SENSOR) may be stored with DTC P0776 and/or P0841.
- If this issue should occur, the vehicle may hesitate and/or have reduced power.

AND/OR

The customer reports a transmission judder (shake, shudder, single or multiple bumps or vibration), with one of the following DTCs stored in the TCM:

- **P17F0** – CVT_JUDDER (T/M INSPECTION)
- **P17F1** – CVT_JUDDER (C/U INSPECTION)

NOTE:

- If DTCs are stored other than those listed above, or P1715 is stored by itself, this bulletin **does not apply**.
- If customer complains of engine stall while going from “P” or “N” range to “R” or “D” range or when coming to a stop, this bulletin **does not apply**.
- NTB15-083, **Enhanced Diagnostic Logic For CVT Judder**, has reprogramming instructions that may apply.

ACTION

- Refer to the **Repair Flow Chart** on page 2 for CVT repair.
CAUTION: Always handle the CVT and component assemblies carefully and with the appropriate lifting tools.
- Pages 59, 85 and 95 must be printed and attached to the repair order.

Nissan Bulletins are intended for use by qualified technicians, not 'do-it-yourselfers'. Qualified technicians are properly trained individuals who have the equipment, tools, safety instruction, and know-how to do a job properly and safely. NOTE: If you believe that a described condition may apply to a particular vehicle, DO NOT assume that it does. See your Nissan dealer to determine if this applies to your vehicle.

Repair Flow Chart

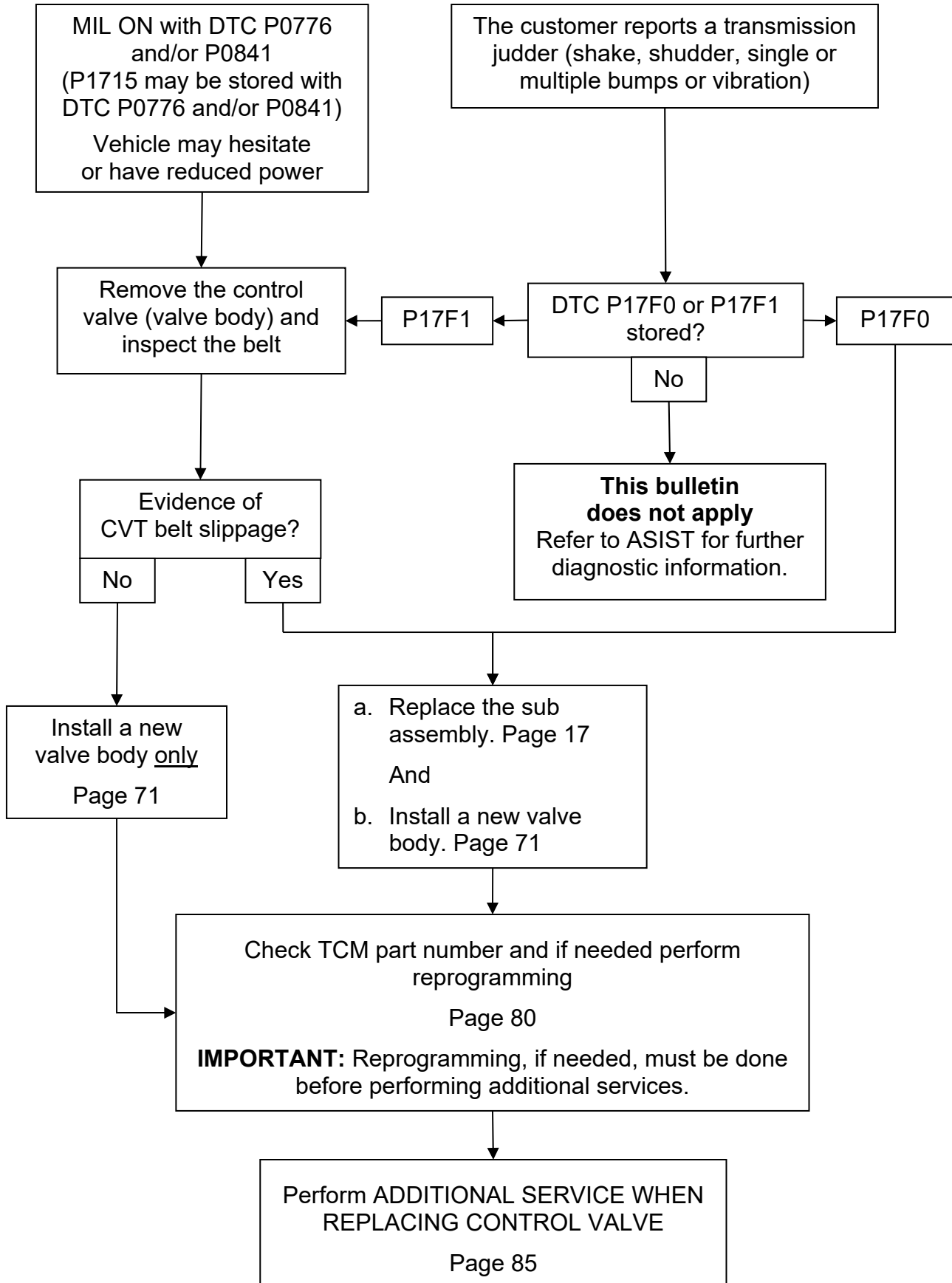

Table of Contents

• Required Tools / Material.....	page 4
• Essential Tools.....	page 4
• Weights.....	page 6
• Precautions when Disassembling a CVT Assembly.....	page 7
• Control Valve (Valve Body) Removal and CVT Belt Inspection.....	page 8
• CVT Assembly Removal.....	page 17
• Remove the Converter Housing, Oil Seals, Oil Pump Cover, Oil Pump and Oil Filter.....	page 20
• Clean the CVT case surfaces.....	page 28
• Clean the Oil Passages in the CVT Case, Oil Pump Cover, and CVT Filter Area.....	page 29
• New Pump Installation.....	page 31
• Replace the Side Cover – Pulleys and Belt (sub-assembly).....	page 33
• Clutch Total Endplay Adjustment – Thrust Bearing Selection.....	page 56
• Clean the Converter Housing Passages.....	page 61
• CVT Reassembly.....	page 63
• Control Valve (Valve Body) Strainer and Pan Installation.....	page 71
• Install the CVT Assembly.....	page 77
• Reprogram TCM.....	page 78
• Perform ADDITIONAL SERVICE WHEN REPLACING CONTROL VALVE.....	page 85
• Trouble Shooting.....	page 90
• PARTS INFORMATION.....	page 92
• CLAIMS INFORMATION.....	page 93
• PARTS KITS REFERENCE TABLE.....	page 95

Required Tools / Materials

- Cherry picker / engine hoist / lifting arm (never handle replacement CVT sub-assembly by hand)
- Strap or chain to lift or lower CVT and sub-assembly
- Petroleum jelly or equivalent
- Extendable magnet
- Large clean surface / 1 to 2 work tables
- Vernier calipers
- Brake cleaner
- Rubbing alcohol
- Plastic scraper

Essential Tools

Additional Essential Tools are available from Tech•Mate online: www.nissantechmate.com, or by phone: 1-800-662-2001.

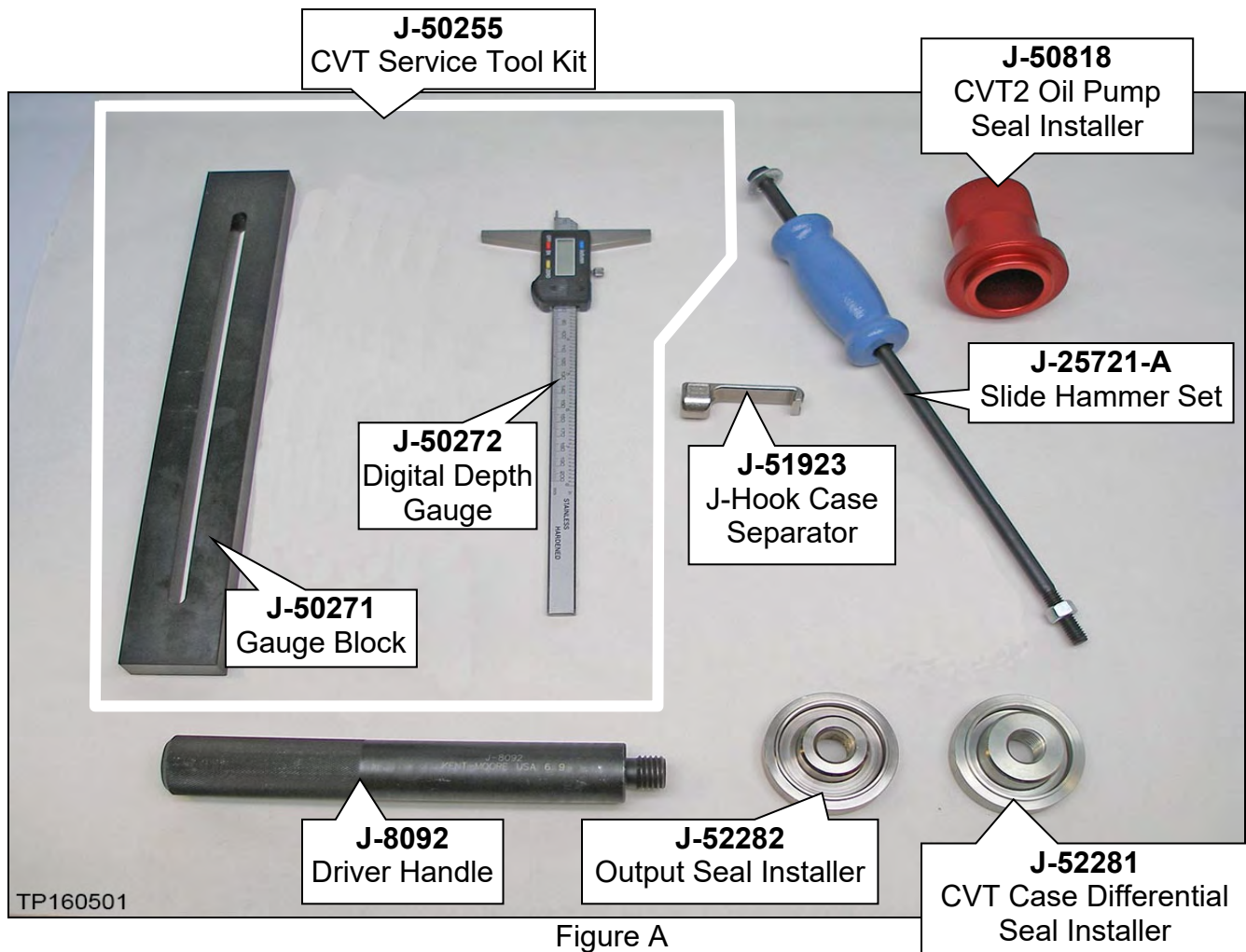

Essential Tools (continued). Tools that are not indicated as specifically for one model are used for both models.



Figure B

J-51959
Guide Pins

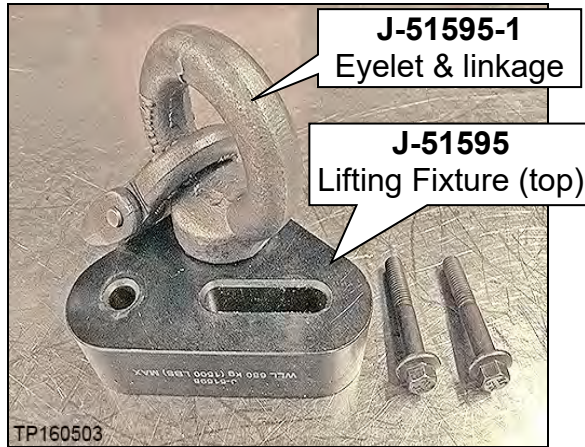

J-51595-1
Eyelet & linkage

J-51595
Lifting Fixture (top)

Figure C

**Use for Rogue
Only**

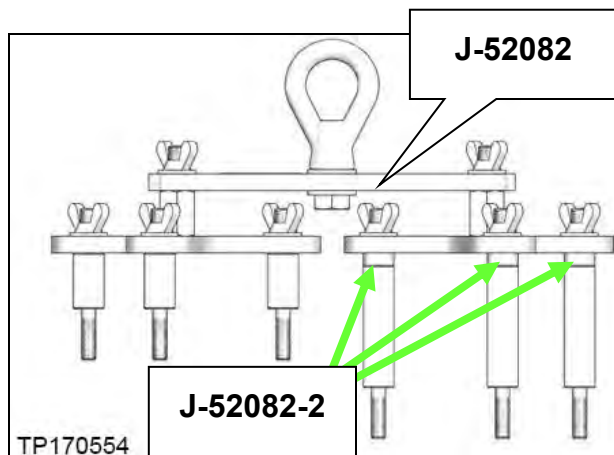

Figure D

Essential Tools (continued)

Use for Altima only

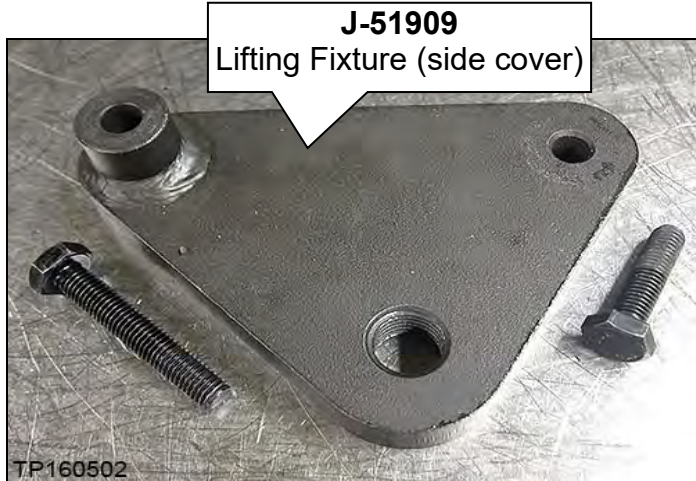

Figure E

Tech Cam J-51951

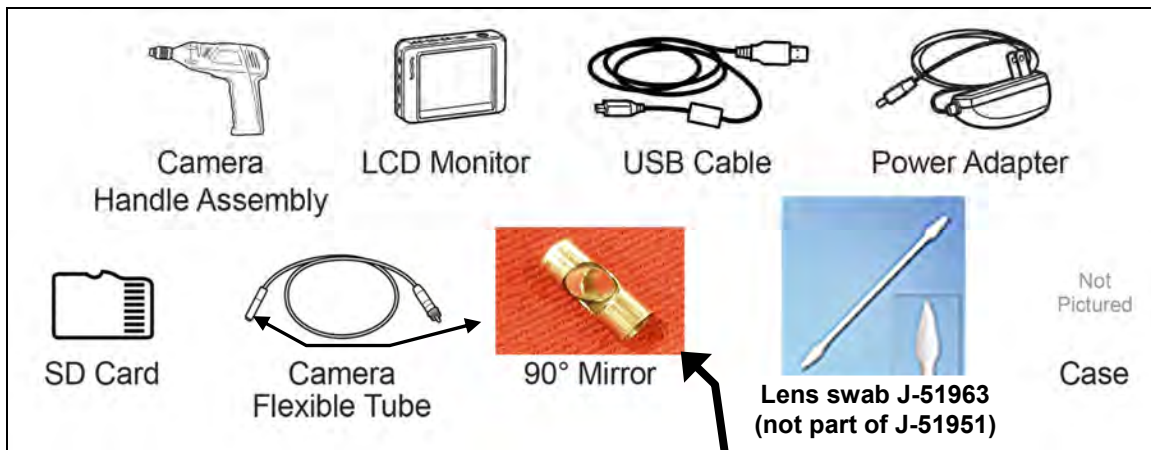

Figure F

Remove protective film before first use

- Additional Tech Cam J-51951 kits or components are available from Tech•Mate.

Weights

- CVT assembly: 300 lbs. approximately
- CVT sub-assembly: 65 lbs. approximately

SERVICE PROCEDURE

Precautions when Disassembling a CVT Assembly

Transmissions are vulnerable to particles (dust, metal, lint, etc.).

When disassembling a CVT, make sure your work environment (shop, workbench, etc.), transmission area (sub-frame, oil pan, harness connector, etc.), and your hands are free of contamination.

IMPORTANT:

- Wash and clean the exterior of the CVT assembly prior to disassembling.
CAUTION: Cover all air breather and drive shaft holes to prevent water intrusion.
- Apply rust penetrant to locator / dowel pins on torque converter housing and side cover of CVT and allow to soak as needed.
- Refrigerating oil seals may help in assembly (axle and T/C seals).
- Only disassemble those parts which are mentioned in this bulletin.
- Make sure all parts are clean prior to assembling / installing.
 - Unpack service parts just before installation.

- Store the related parts that have been removed separately to prevent being mixed up; small cups can be used.

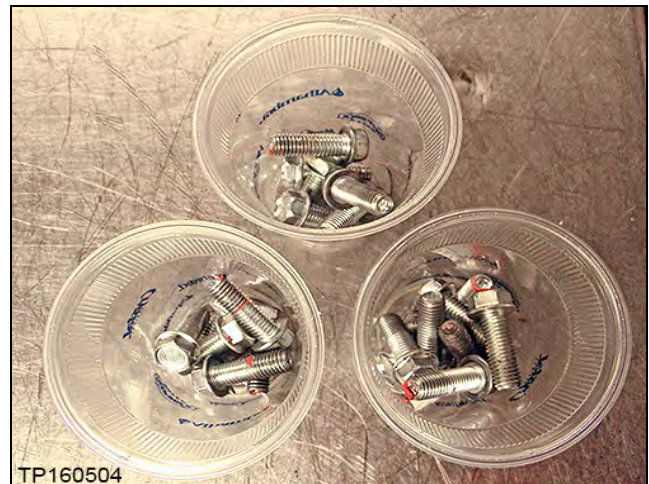

Figure G

IMPORTANT: The CVT unit “wiring harness connector” will be reused during this procedure. The wiring harness can be disconnected from the valve body at the wiring harness connector and remain in the CVT.

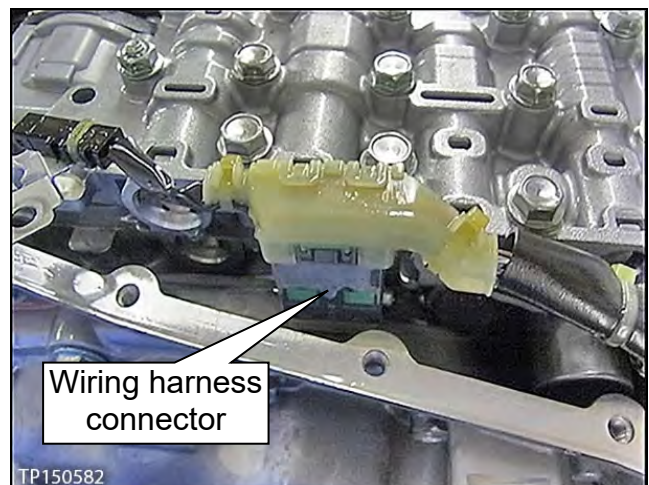

Figure H

Control Valve (Valve Body) Removal and CVT Belt Inspection

1. Write down all radio station presets.

Presets	1	2	3	4	5	6
AM						
FM 1						
FM 2						
SAT 1						
SAT 2/3						
Bass	Treble		Balance	Fade	Speed Sen. Vol.	

2. Disconnect both battery cables, negative cable first.

3. Remove the valve body.

- Before lifting the vehicle;
 - Place the transmission gear selector in Neutral.
- Refer to the appropriate ESM, section **TM – Transaxle & Transmission**, for valve body removal.

NOTE: The number '7' is on the head of all bolts that need to be removed for valve body removal. Do not remove any bolt that does not have the number '7'.

CAUTION: Never allow any chemicals or fluids other than NS-3 CVT fluid or equivalent to enter the CVT assembly. Never allow any foreign debris, dust, dirt, etc. to enter the CVT assembly.

- For additional information, see video # 544: "CVT Belt Inspection". This video is located under the TECH TRAINING GARAGE VIDEOS tab in Virtual Academy.

Exploded View

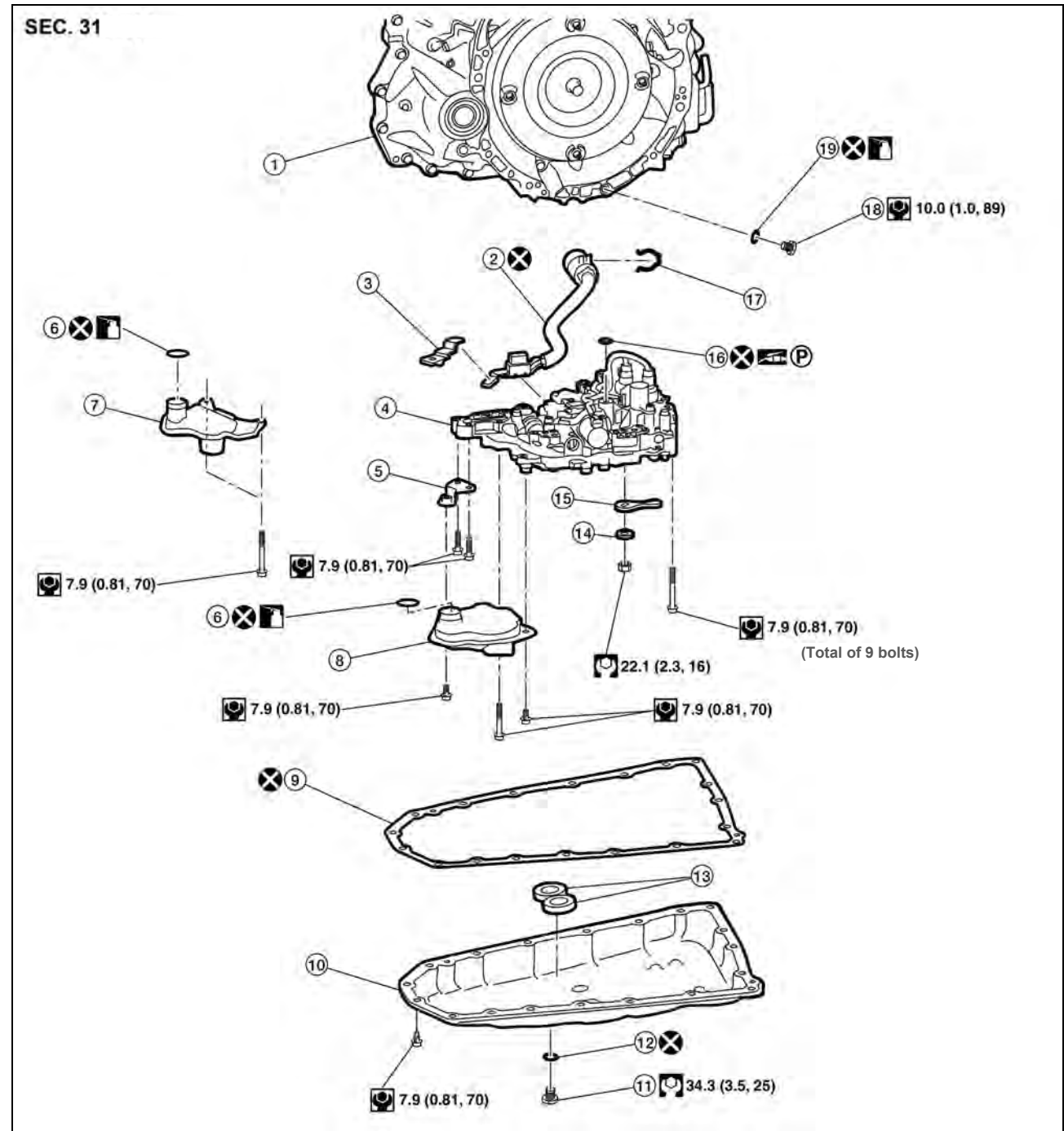

Figure 1A

- | | | |
|------------------------------------|------------------------------------|---|
| 1. Transaxle assembly | 2. Terminal cord assembly | 3. CVT fluid temperature sensor bracket |
| 4. Control valve | 5. Bracket | 6. O-ring |
| 7. New-style oil strainer assembly | 8. Old-style oil strainer assembly | 9. Oil pan gasket |
| 10. Oil pan | 11. Drain plug | 12. Drain plug gasket |
| 13. Magnet | 14. Spring washer | 15. Manual plate |
| 16. Lip seal | 17. Snap ring | 18. Overflow plug |
| 19. O-ring | | |

⊗ : Always replace after every disassembly.

⊙ : N·m (kg-m, ft-lb)

⊙ : N·m (kg-m, in-lb)

4. Secure the front right tire with a suitable strap.
 - This will assist in making the belt turn.
5. Mark the front left tire with a suitable marking.
 - This will assure all 360° of the belt is inspected.



Figure 2A

6. Using borescope J-51951 with mirror attachment, inspect the entirety of the two sides of the belt that come in contact with the pulleys (see page 12, Figure 7A). Reference the pictures on pages 12 through 16 for comparison.

NOTE:

- Be sure to remove the protective film from the mirror before the first use.
- Clean the camera lens and mirror before each inspection. Use 90% isopropyl alcohol, and a lens swab from Lens Swab packet J-51963 listed in the **PARTS INFORMATION**.
- Before inspecting, make sure the camera handle's AA batteries are fresh and the LCD monitor's battery is charged.

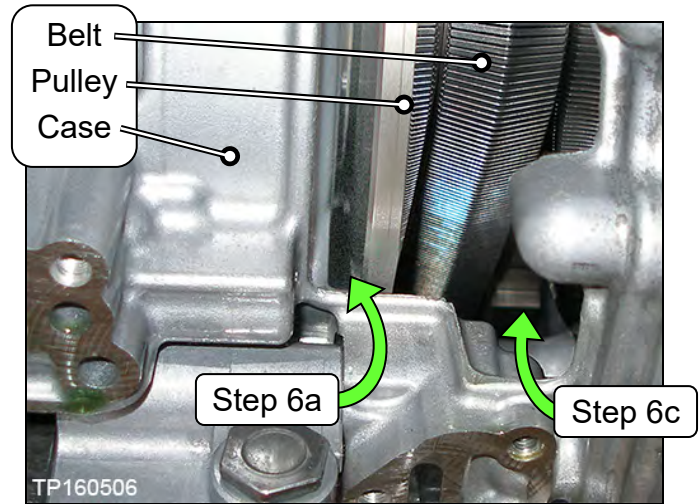

Figure 3A

- a. Insert the camera lens between the CVT case and pulley where shown in Figures 3A and 4A.
 - Insert the lens approximately seven (7) inches, and then view the side of the belt that contacts the pulley.

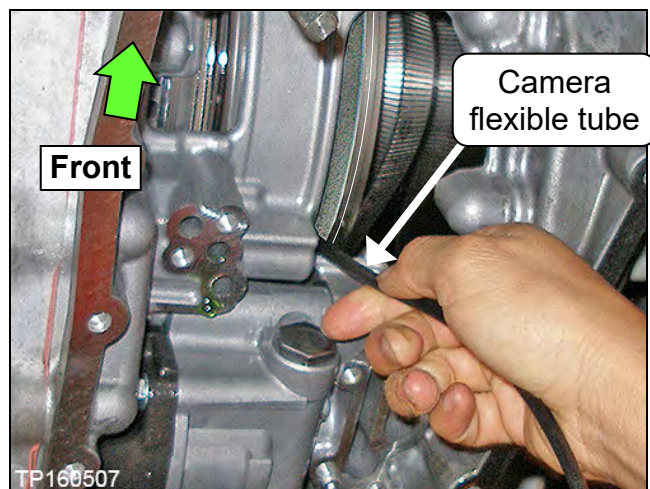

Figure 4A

- b. Slowly and carefully turn the front left tire one full turn in the forward rotation to view all of the belt.

- Holding the borescope with one hand allows for turning the tire with the other hand (see Figure 5A).

CAUTION: If the tire is rotated in the rearward rotation, the camera lens may get caught between the belt and pulley.

- c. If the inspection result is OK, inspect the other side of the belt.

- Insert the camera lens in the second location where shown in Figure 3A and 6A, and then perform step 6b again.

- d. If the inspection result is OK 360° on both sides of the belt, proceed to step 7 on the next page.

- For additional information, see video # 544: "CVT Belt Inspection". This video is located under the TECH TRAINING GARAGE VIDEOS tab in Virtual Academy.

- e. If the inspection result is NG, proceed to step 8 on the next page.



Figure 5A

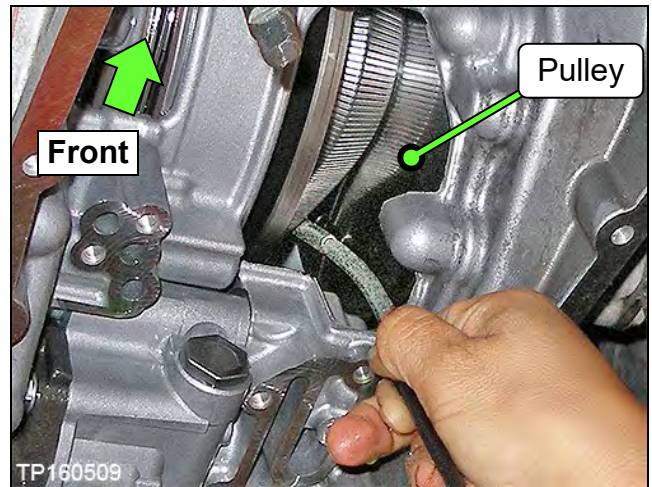

Figure 6A

7. If the belt inspection result is OK, replace only the valve body, and then check step 6 on page 80 to confirm if a TCM reprogram is available.
 - For valve body replacement, go to page 71, **Control Valve (Valve Body) Strainer and Pan Installation**.

8. If the belt inspection result is NG, replace the CVT sub-assembly and valve body, and then check step 6 on page 80 to confirm if a TCM reprogram is available.
 - Go to **CVT Assembly Removal**, page 17.

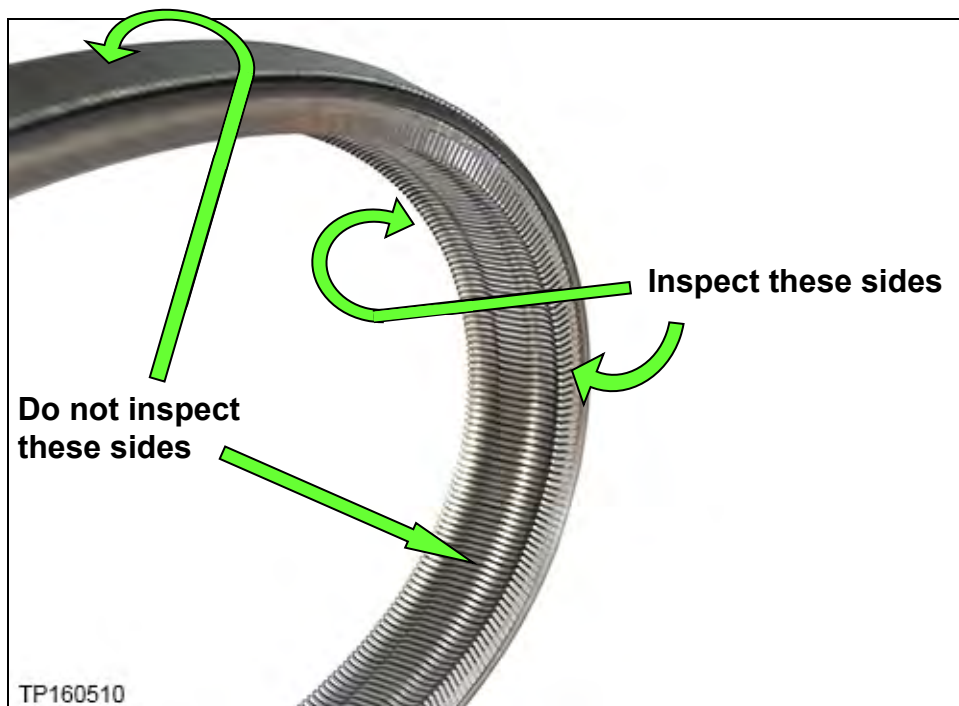

Figure 7A

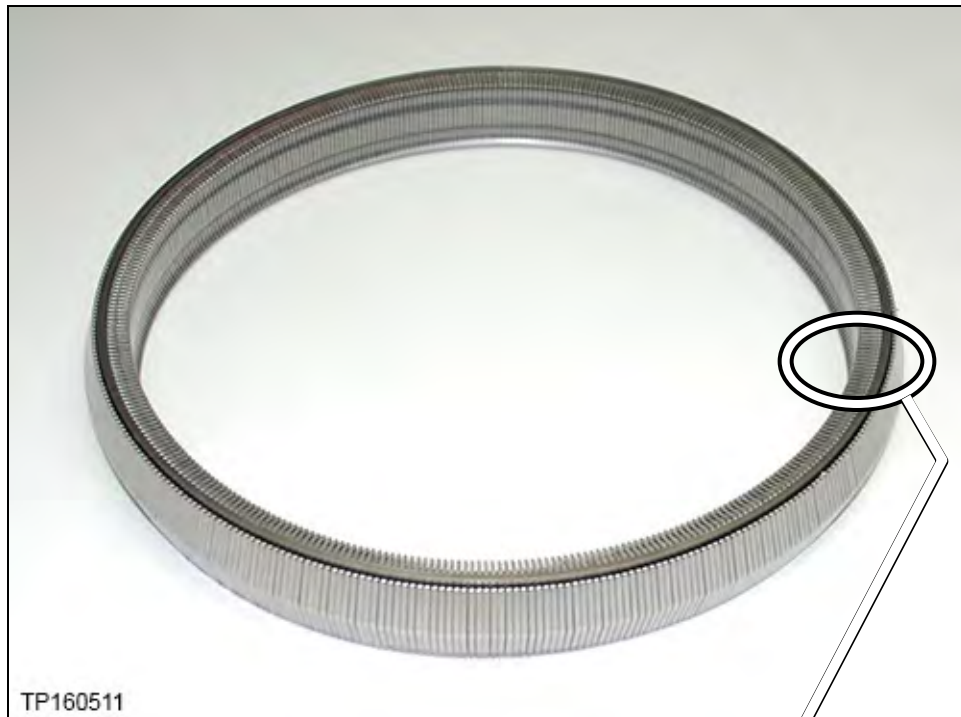

Figure 8A: New belt



Figure 9A: Close-up of section to be inspected

Pictures in Figures 10A and 11A were taken with borescope J-51951.

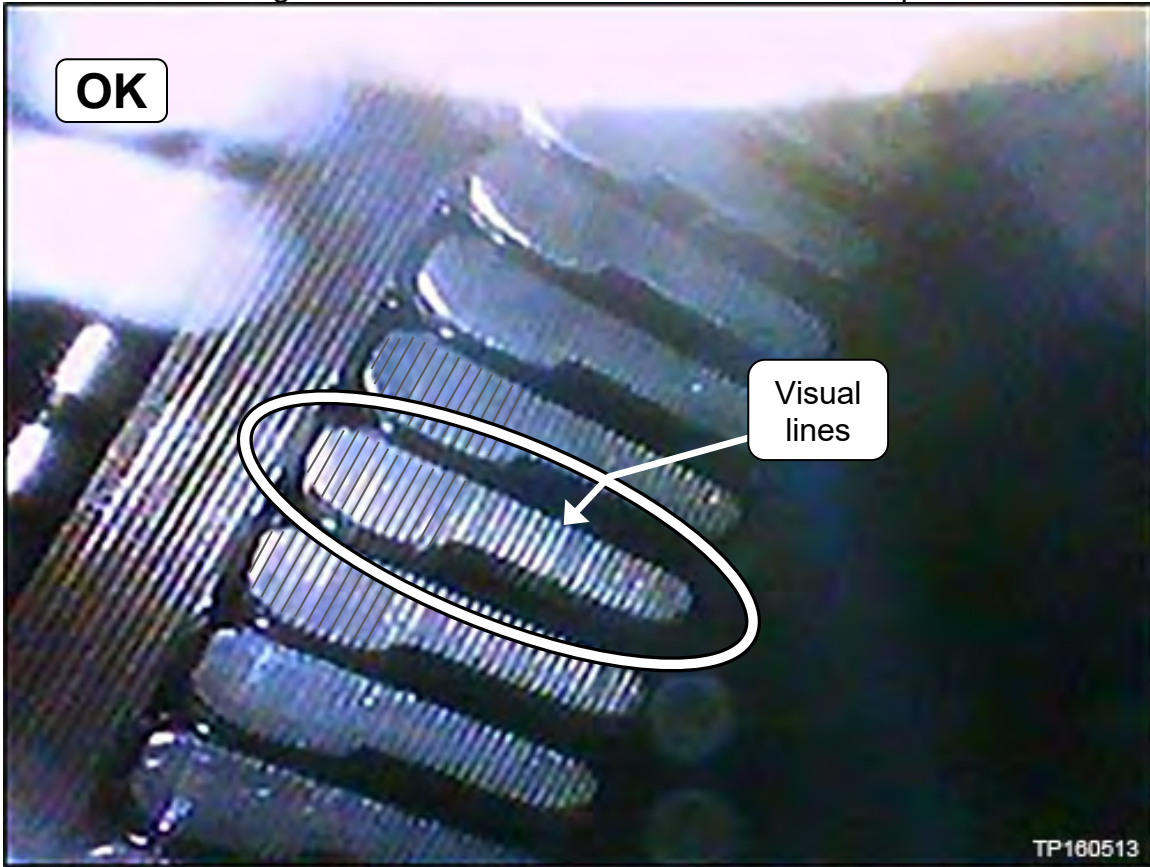

Figure 10A: Belt is OK

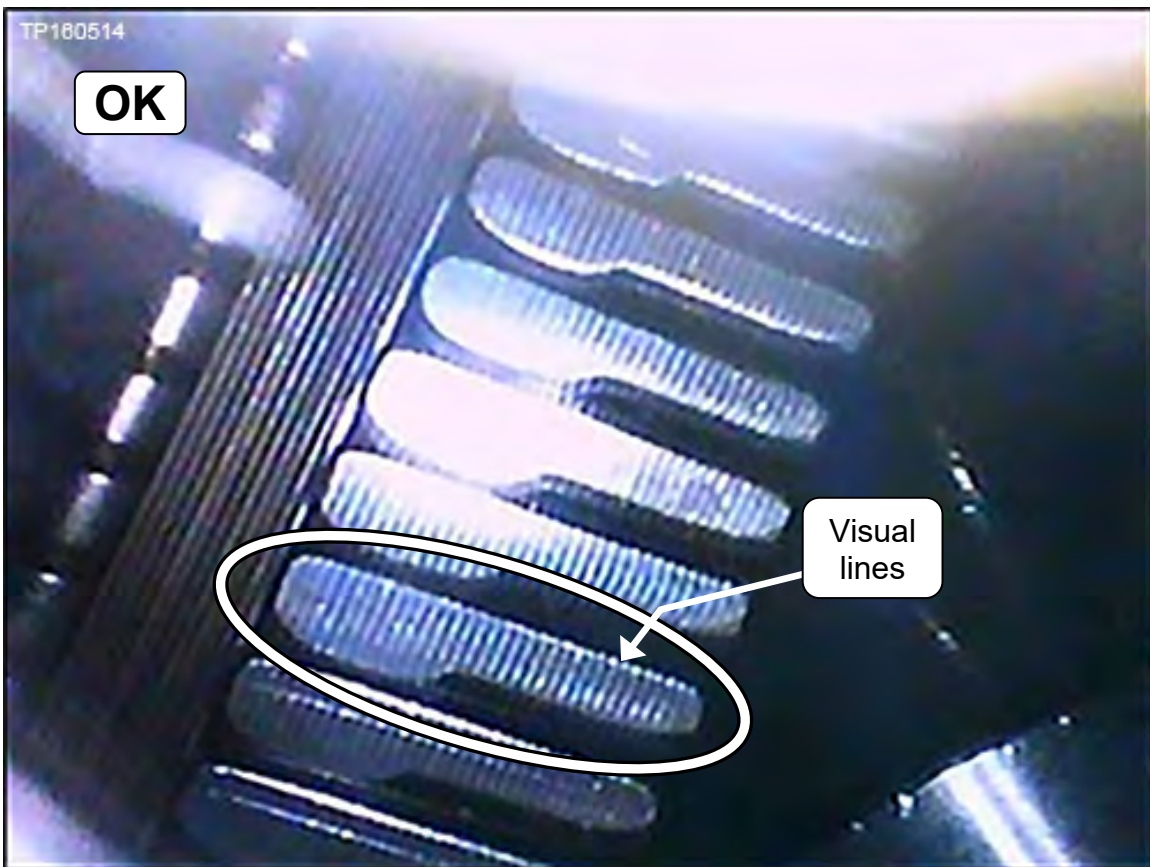

Figure 11A: Belt is OK

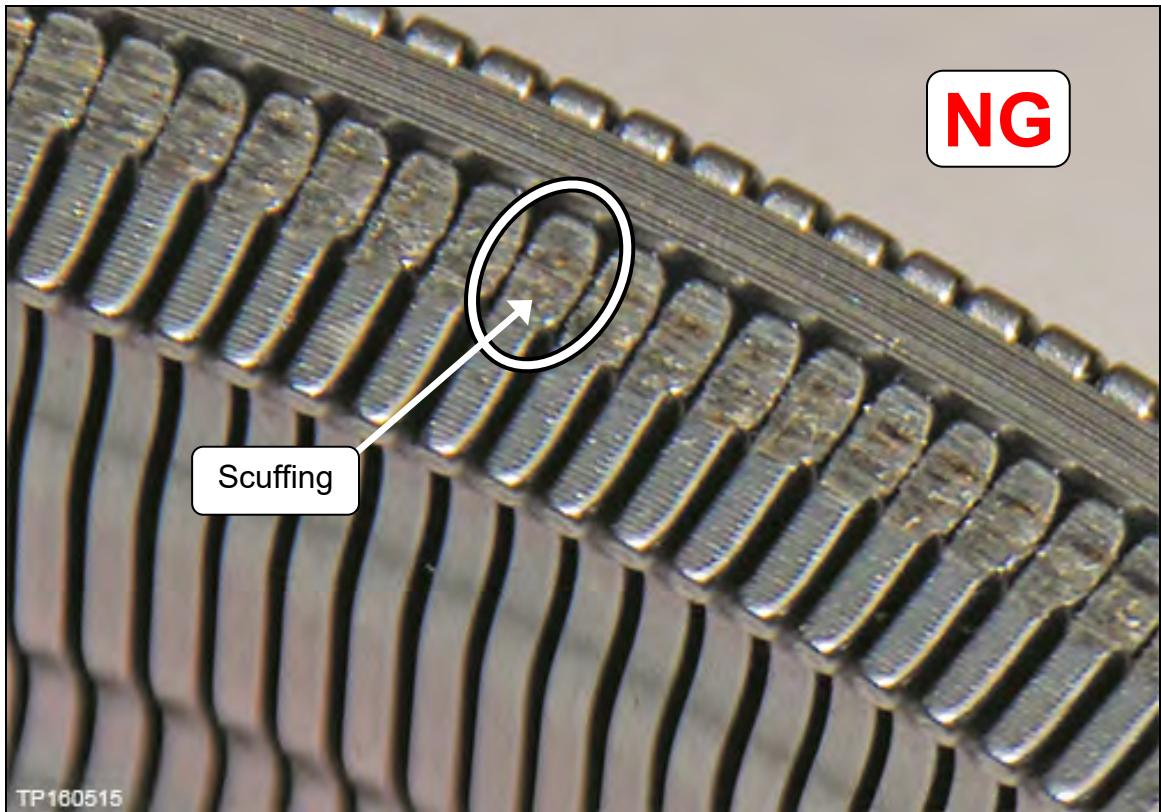

Figure 12A: Example of NG belt

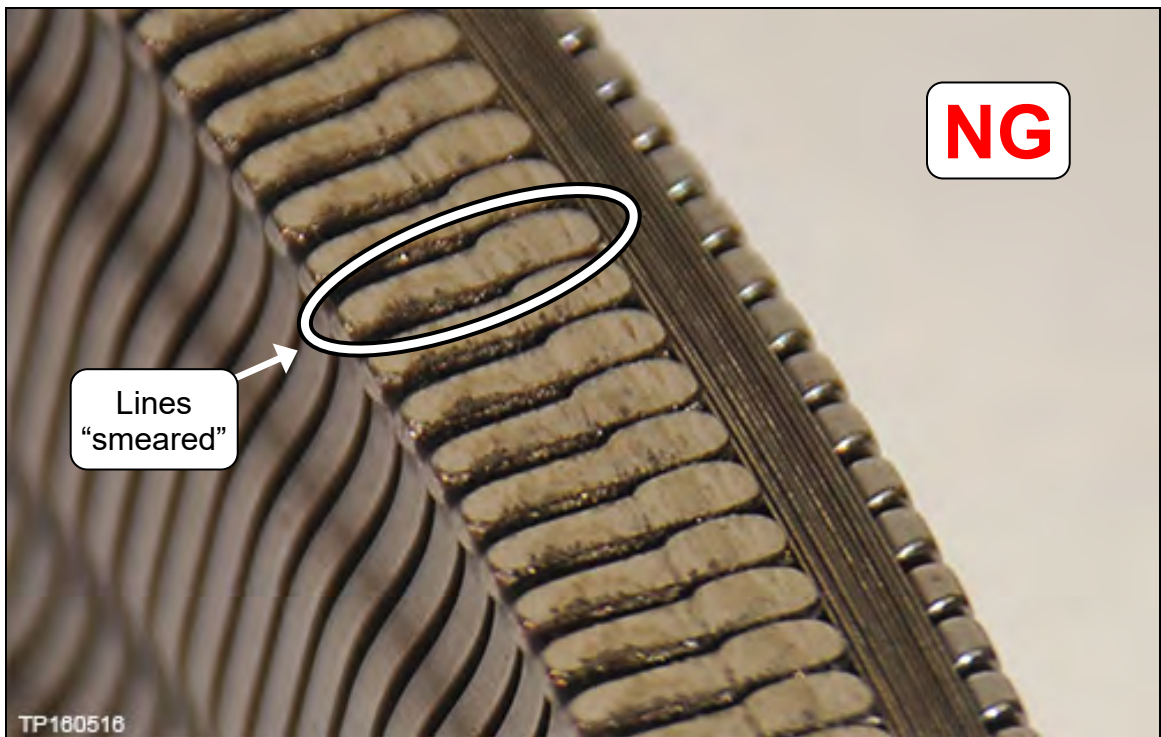

Figure 13A: Example of NG belt

Pictures in Figures 14A-16A were taken with borescope J-51951.



Figure 14A: Example of NG belt



Figure 15A: Example of NG belt



Figure 16A: Example of NG belt

CVT Assembly Removal

Overview of Sub-assembly Repair

1. Apply rust penetrant as necessary to the dowel pins on the converter housing side and sub-assembly side cover
2. Removal of the CVT from the vehicle
3. Remove the Converter Housing, Oil Seals, Oil Pump Cover, Oil Pump and Oil Filter
4. Clean the CVT case surfaces
5. Clean the Oil Passages in the CVT Case, Oil Pump Cover, and CVT Filter Area
6. Check initial pulley movement characteristics
7. New Pump Installation
8. Replace the Side Cover – Pulleys and Belt
9. Confirm shift selector movement
10. Recheck new pulley movement characteristics matches that of the original assembly
11. Clutch Total Endplay Adjustment – Thrust Bearing Selection
12. Clean the Converter Housing Passages
13. CVT Reassembly
14. Control Valve (Valve Body) Strainer and Pan Installation
15. Install the CVT Assembly

NOTE: For additional information review video # 547: “**CVT Belt and Pulley Replacement**”.

- This video is located under the **TECH TRAINING GARAGE VIDEOS** tab in Virtual Academy.

1. Temporarily install the oil pan gasket and oil pan with four oil pan bolts to corners of the oil pan, hand tight (Figure 1B).

NOTE: If the control valve has not yet been reinstalled, it is not necessary to do so. A new one will be installed later in this service procedure.

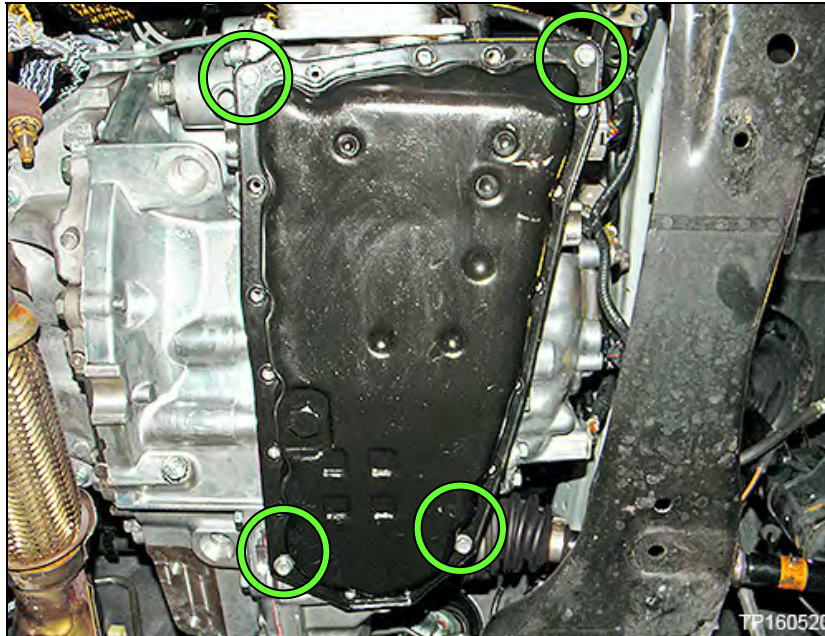

Figure 1B

2. Remove the CVT from the vehicle.
 - Refer to the Electronic Service Manual (ESM), section **TM-Transaxle & Transmission** for removal information.

AWD Vehicles

CAUTION:

- Use extreme care when moving the axle in and out of the transfer assembly.
- To avoid seal damage or deformation, properly support and guide the axle.

3. Place the CVT on a workbench with the oil pan side down.
 - Use wood or plastic blocks to keep the CVT steady.

CAUTION: Do not deform the oil pan.
4. Remove the torque converter.

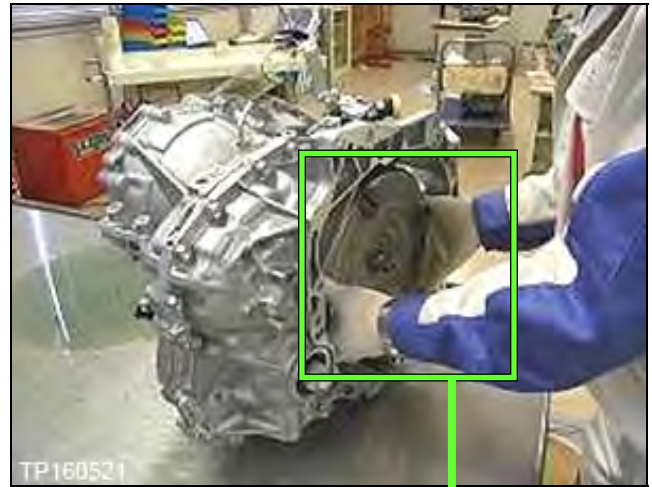

Figure 2B

5. Drain CVT fluid out of the torque converter.



Figure 3B

6. Remove the primary speed sensor.

IMPORTANT: The speed sensor will be re-used.

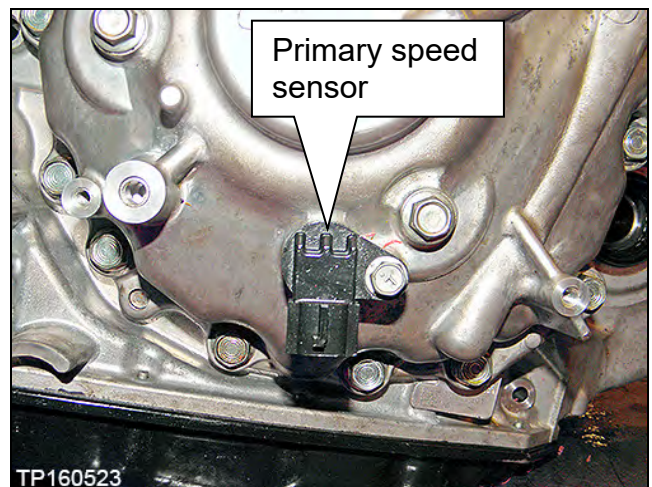

Figure 4B

Remove the Converter Housing, Oil Seals, Oil Pump Cover, Oil Pump and Oil Filter

1. Remove all 23 converter housing mounting bolts (see Figure 1C).

NOTE:

- These bolts will be replaced with new ones and will not be reused.
- Apply rust remover to the dowel pins if needed.

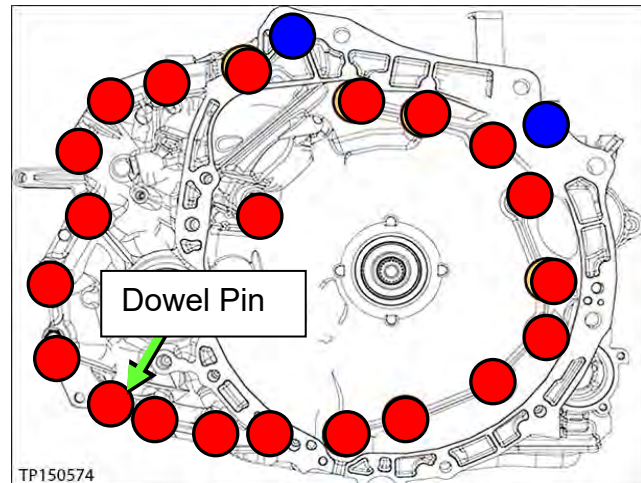

Figure 1C

2. Separate and then remove the converter housing from the CVT case.
 - Use Slide Hammer J-25721-A and Slide Hammer Bolt J-50255-UPD with J-Hook J-51923 at the cut out areas similar to the one shown in Figure 2C and Figure 3C.

CAUTION: DO NOT use a pry-bar, chisel, etc. to separate the side cover from the CVT case.

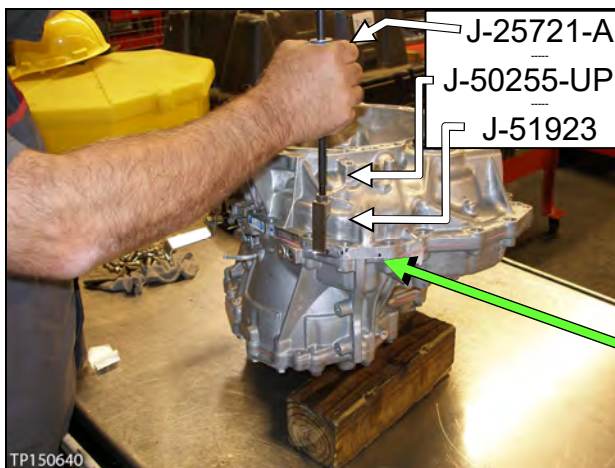

Figure 2C

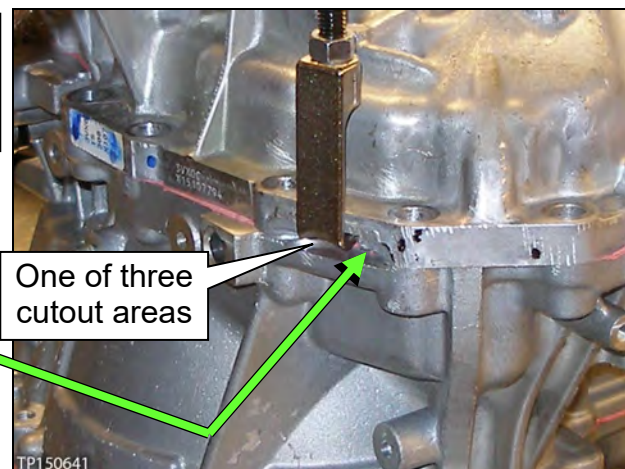

Figure 3C

3. Note the location of the pin shown in Figure 4C.

CAUTION: This pin can slip out during movement of the CVT while converter housing is removed.

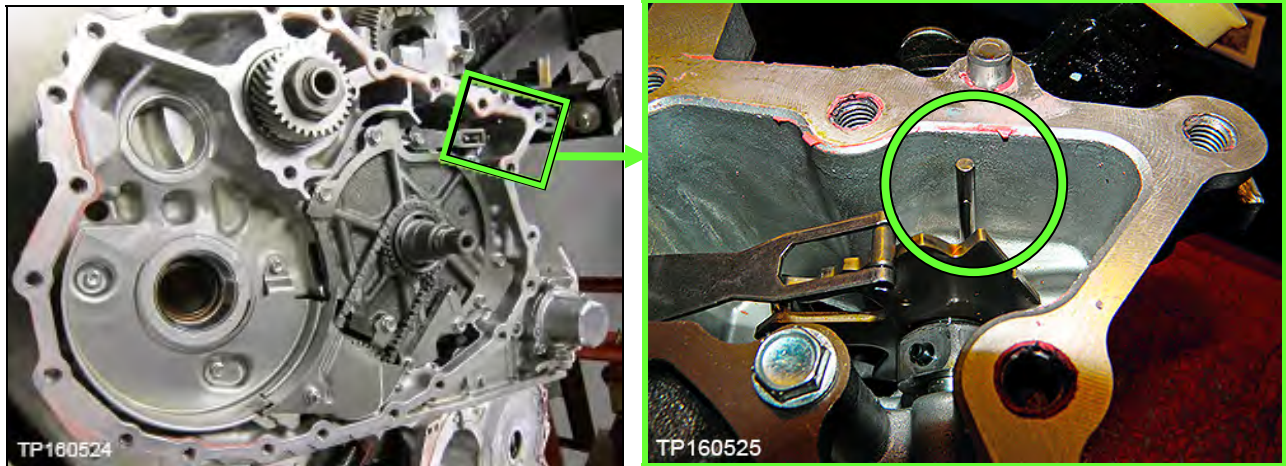

Figure 4C

4. Remove the O-ring from the input shaft.

- This O-ring will be replaced with a new one.

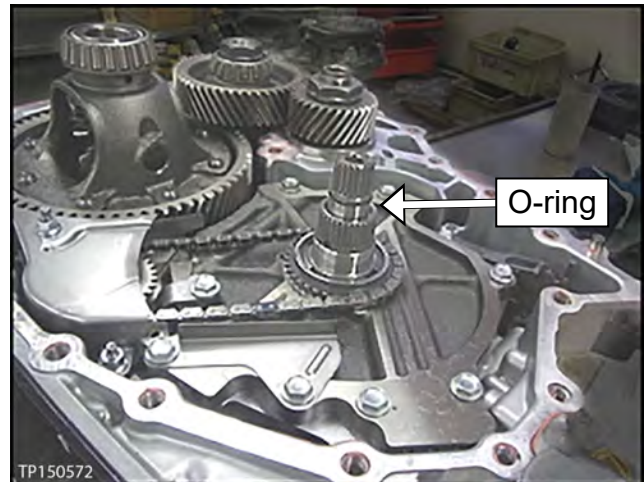

Figure 5C

5. Carefully remove the reduction gear assembly (Figure 6C).

6. Carefully remove the differential assembly (Figure 7C).

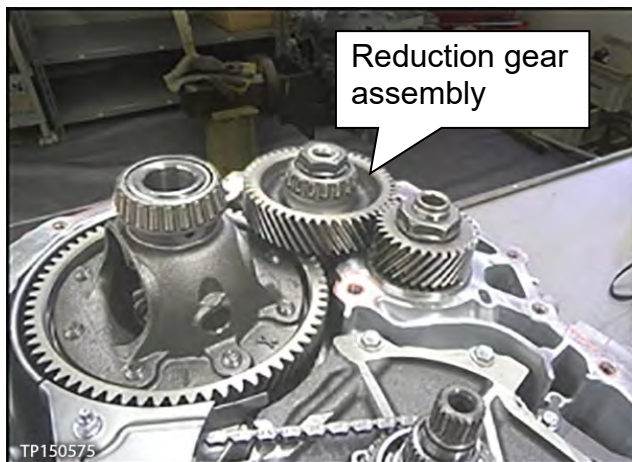

Figure 6C

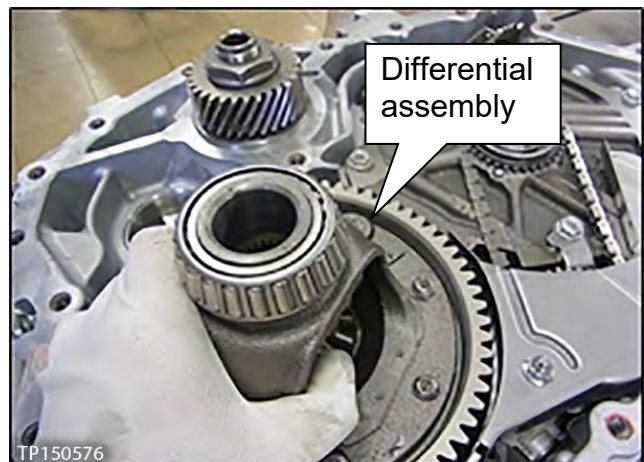

Figure 7C

7. Remove the following oil seals using suitable tools:

CAUTION: Be careful not to damage any of the seal bore surfaces.

- a. CVT case differential side oil seal (drive shaft seal).
- See Figure 8C.

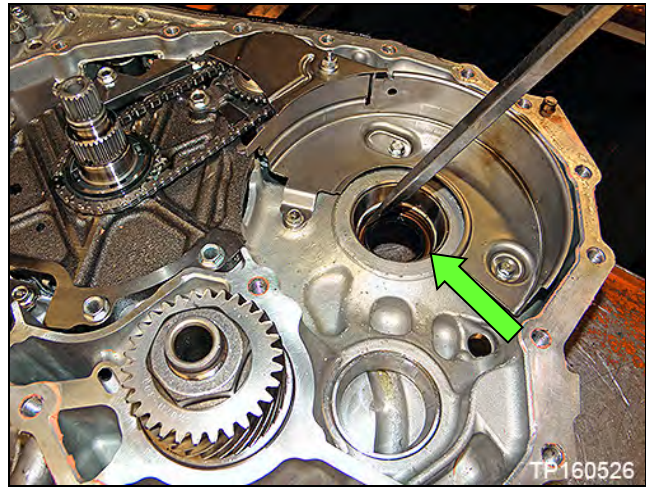

Figure 8C

- b. Torque converter seal (Figure 9C).

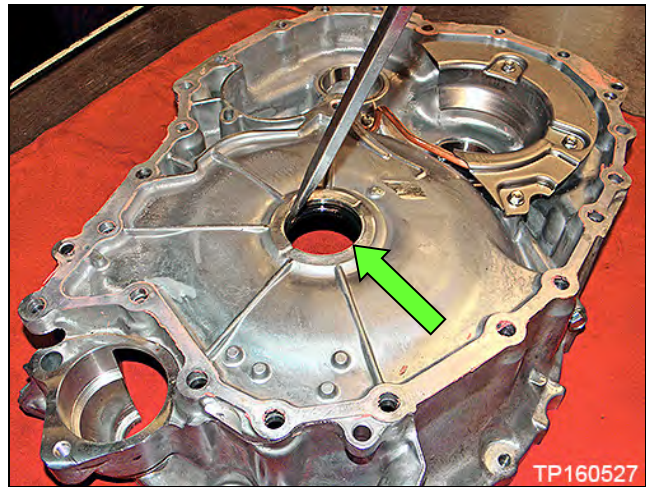

Figure 9C

- c. Converter Housing differential side oil seal (drive shaft seal).
- See Figure 10C.

NOTE: All wheel drive transfer case O-ring will be replaced later in this procedure.

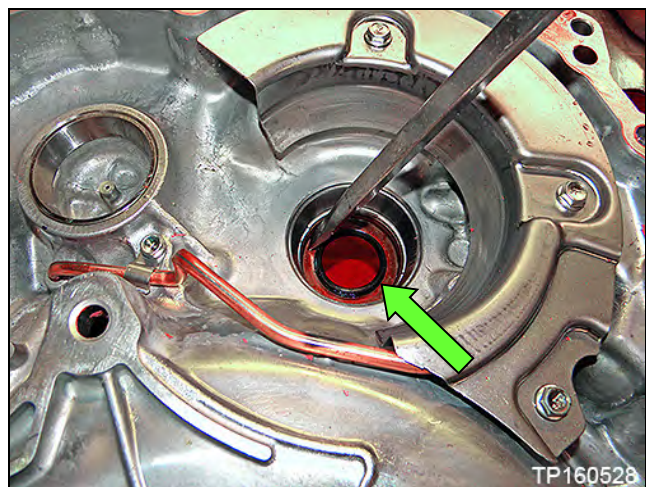

Figure 10C

- Remove the two (2) nuts from baffle plate A, and then remove baffle plate A (see Figure 11C).

CAUTION: To avoid rounding off these nuts, it is best to use a 3/8 inch drive 6-pt 10 mm socket.

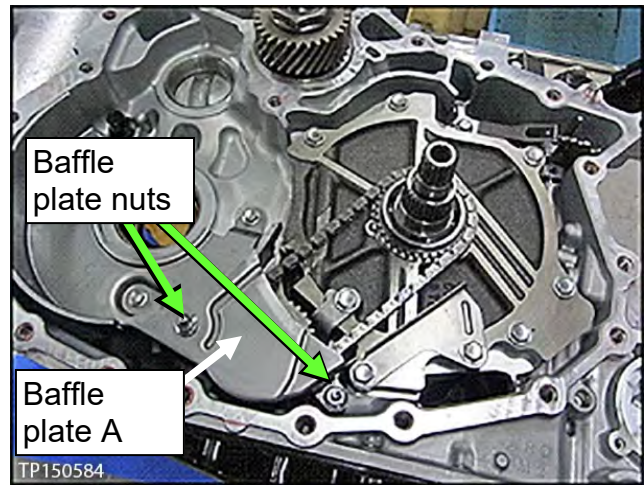

Figure 11C

- Remove the oil pump chain, driven and drive sprockets as one assembly (Figure 12C).
 - Spread the snap ring to remove sprocket (Figure 13C).

IMPORTANT: The drive sprocket has a specific top and bottom. Keep the sprockets and chain together after removed.

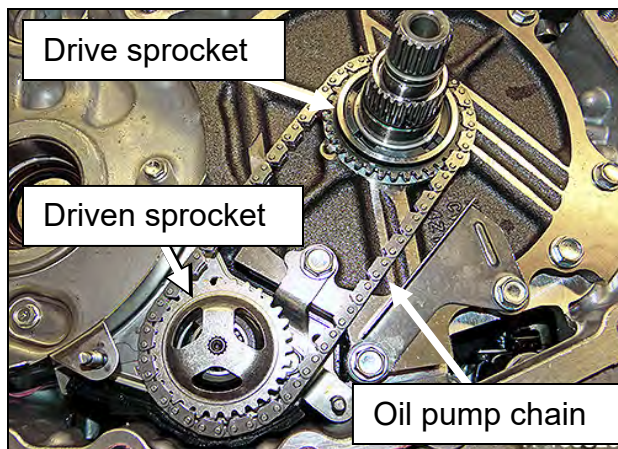

Figure 12C

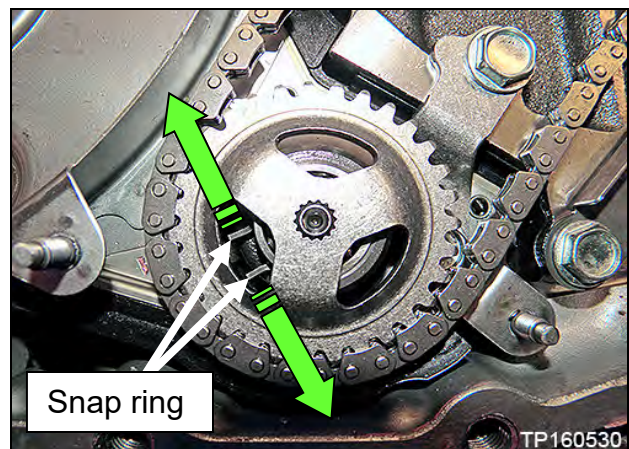

Figure 13C

10. Remove the following:

- a. "Pump cover" (dummy cover) thrust washer (Figure 14C).
 - This thrust washer will be reused.

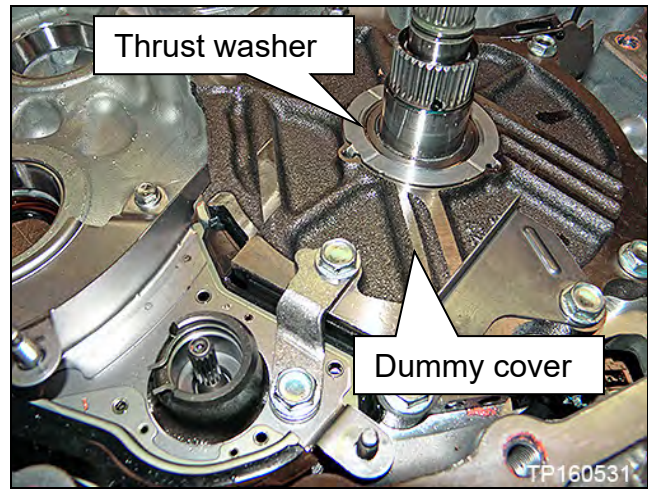

Figure 14C

- b. Oil pump snap ring (Figure 15C).
 - Lightly push the ends of the snap ring together, rotate one side upwards while pulling the snap ring towards the pump opening.

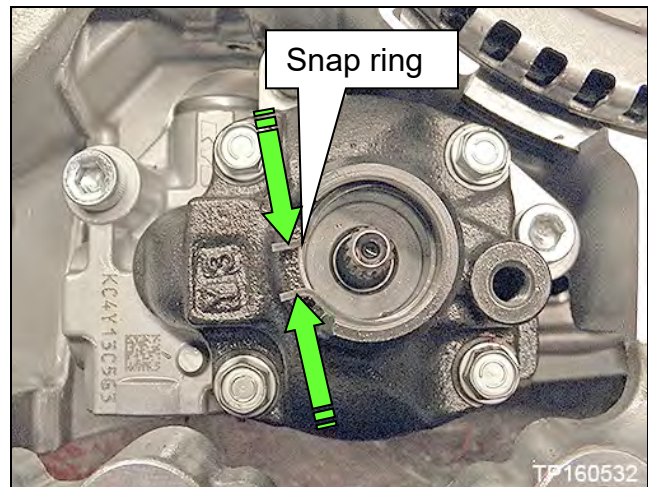

Figure 15C

- c. Oil pump bracket (Figure 16C).
 - Retained by two bolts.

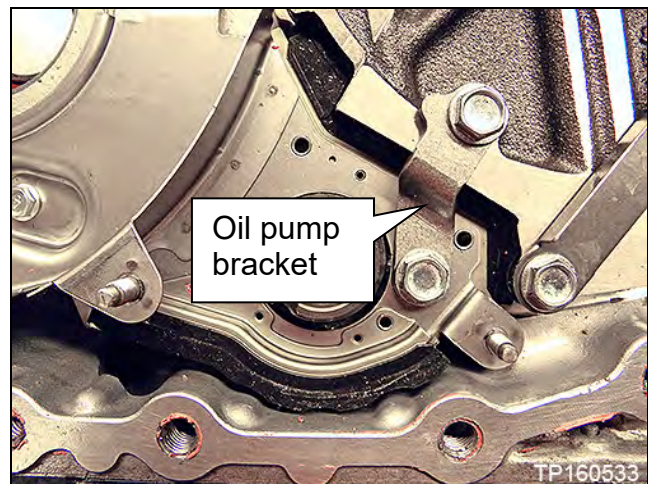

Figure 16C

11. Remove the three bolts from baffle plate B, and then remove baffle plate B (Figure 17C).

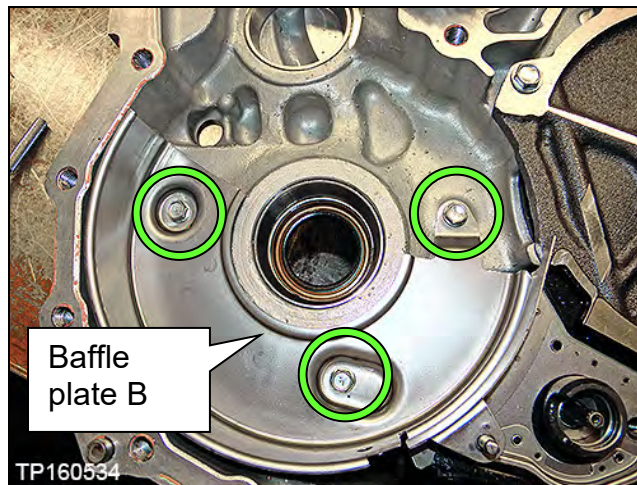

Figure 17C

12. Remove the two bolts from baffle plate C, and then remove baffle plate C (Figure 18C).

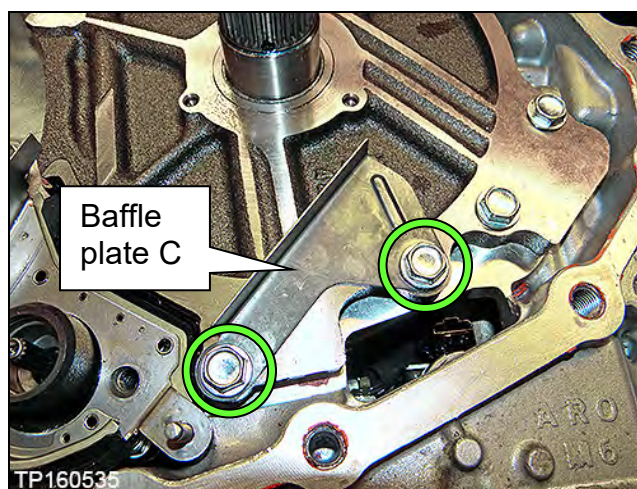

Figure 18C

13. Remove the five dummy cover bolts, and then remove the dummy cover. See Figure 19C.

NOTE: These bolts will be reused.

IMPORTANT:

- Lift the dummy cover from sides **ONLY**. Do **NOT** lift from the input shaft (Figure 19C). This can lift the clutch pack out.
- Do **NOT** remove the lathe cut seals (white seals in Figure 20C) from the dummy cover. These seals will be reused.
- **Lathe cut seals must be in correct positions during final assembly to prevent drivability issues.**

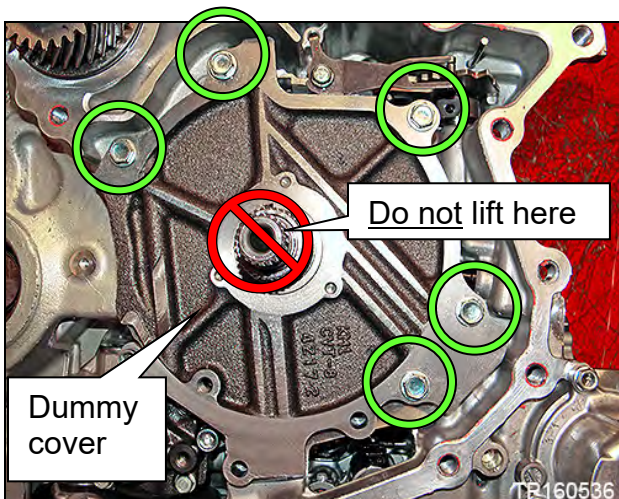

Figure 19C

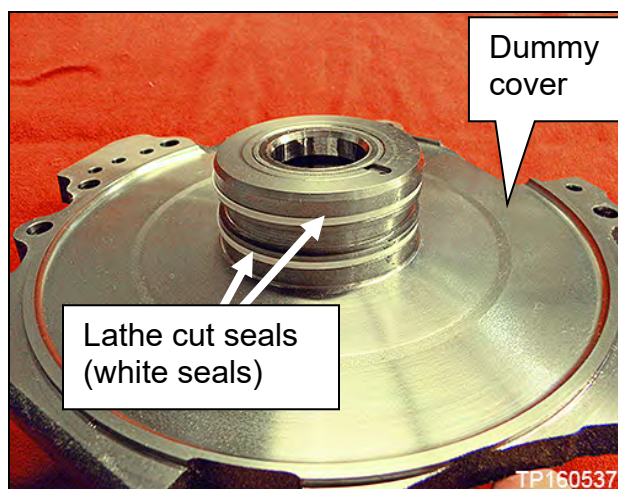

Figure 20C

14. Remove the thrust bearing from the clutch assembly bore (Figure 21C).

NOTE: Take care removing the thrust bearing so that the lathe cut seals are not knocked out of their grooves.

IMPORTANT:

- The thrust bearing has two different sides. As the thrust bearing is removed, note the thrust bearing orientation so that the new bearing can be installed in the same orientation.
- This bearing will not be re-used.

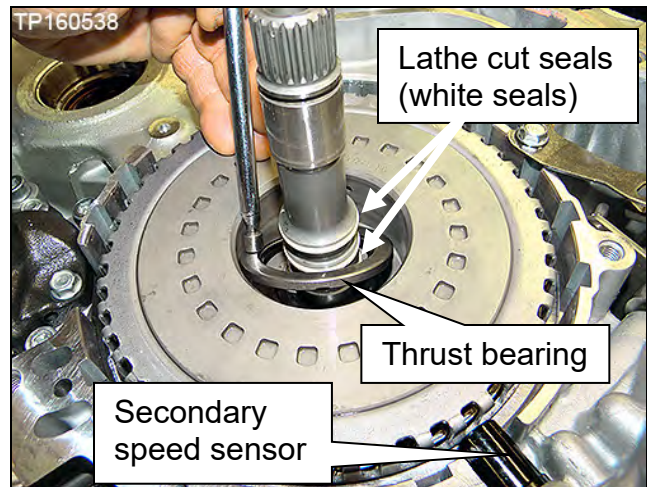

Figure 21C

15. Wipe any metallic debris from the face of the secondary speed sensor (Figure 21C).

16. Remove the oil pump as follows:

- a. Remove the fitting bolt located above the left rear corner of the oil pan gasket surface (Figure 22C).

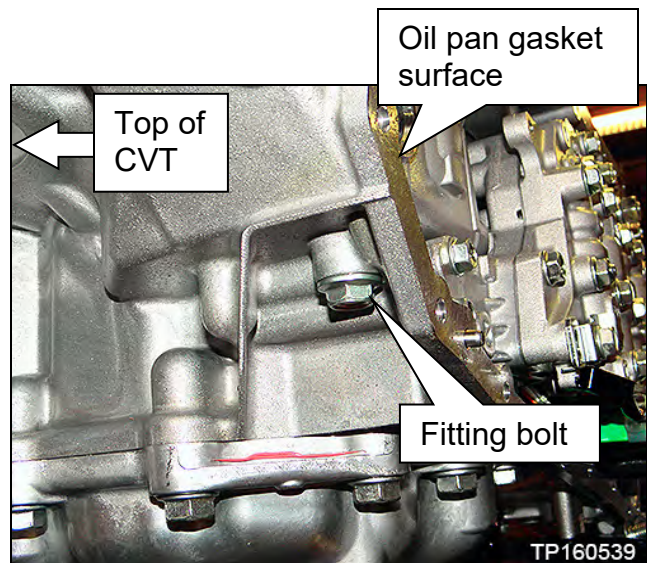

Figure 22C

- b. Remove the three oil pump Allen-head bolts, and remove the oil pump (Figure 23C).

NOTE:

- Do NOT discard the Allen-head bolts. Bolts will be re-used.
- New oil pump will be installed at later steps.

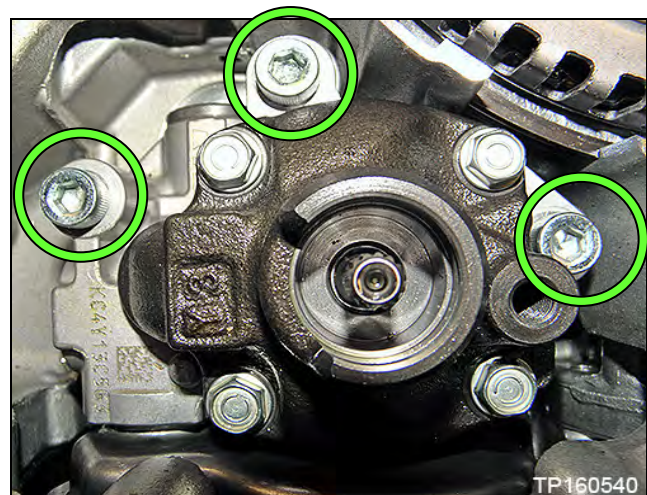

Figure 23C

17. Remove CVT fluid filter as follows:

- a. Remove the 4 bolts and then remove the CVT fluid filter cover (Figure 24C).

NOTE: Bolts will be reused.

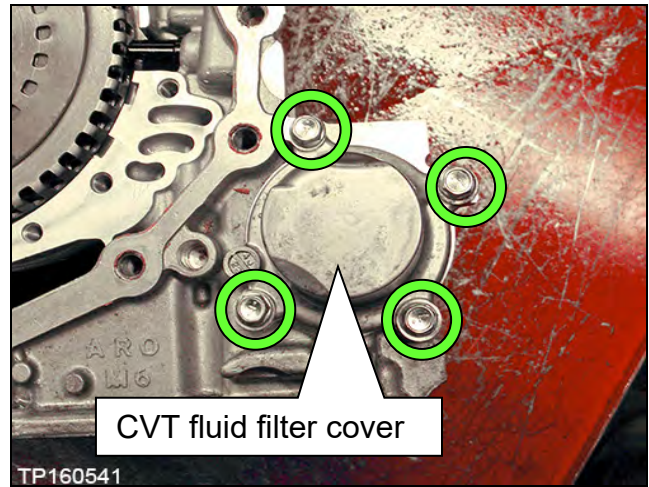

Figure 24C

- b. Remove the CVT fluid filter with grommet seal and O-ring seal (Figure 25C).

- Discard the oil filter and seal. They will be replaced.
- Grommet is fitted to the bottom end of the filter and is included with replacement filter (Figure 26C).

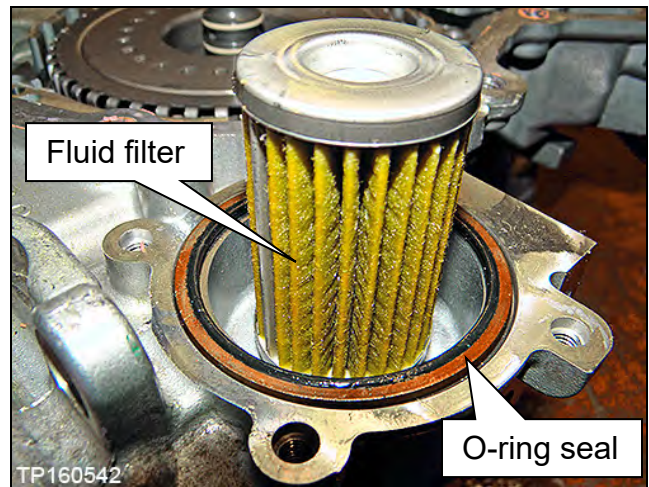

Figure 25C



Figure 26C

Clean the CVT case surfaces

1. Thoroughly clean the mating surfaces of the CVT case and Torque Converter Housing.

- A plastic scraper can be used.

CAUTION:

- **DO NOT** use sanding discs, similar abrasive tools, or metal blades.
- Use brake spray or equivalent solvent and lint-free towels only.
- Make sure brake spray or solvents used are compatible with local regulations.
- Avoid debris entering into the inside of the CVT.
- Make sure rust and debris have been cleaned off of dowel pins and receiving holes (Figure 1C).

2. Clean the dowel pins and dowel pin receiving holes of any rust or debris (Figure 1D).

NOTE: Use small wire brush or similar tool at the inside surface of dowel pin holes. **DO NOT SCRAPE CVT CASE** mating surfaces.



Figure 1D

Clean the Oil Passages in the CVT Case, Oil Pump Cover, and CVT Filter Area

In the following steps:

- Brake spray or a suitable cleaning solvent and compressed air will be used to clean out oil passages in the CVT assembly.
 - Make sure the brake spray or solvents are compatible with local regulations.

WARNING: Wear eye / face protection when using compressed air and cleaning fluids.

CAUTION: Regulate air pressure up to a maximum of 75 PSI.

1. Clean the area where the CVT fluid filter fits (Figure 2D).
 - Make sure the old filter grommet seal is removed.
2. Clean the fluid passages to and from the filter (Figure 2D).

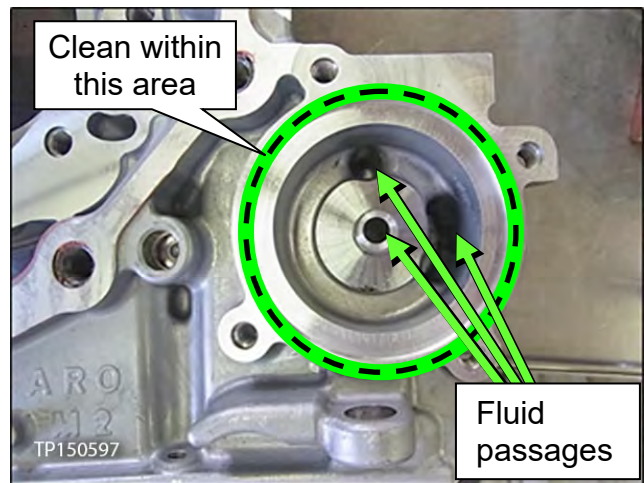

Figure 2D

3. Spray brake clean in all oil passages of the CVT case where shown in Figure 3D and Figure 4D.

- Do not spray brake clean into the clutch pack.

4. Apply compressed air in the same passages.

NOTE: Do not stand in front of the passages while using compressed air.

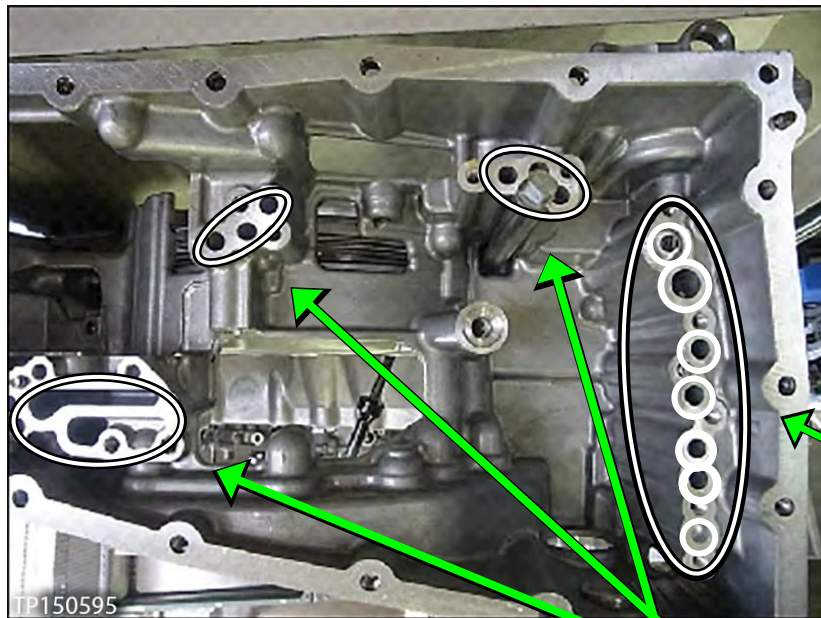

Figure 3D

Apply cleaner, and then 75 PSI maximum air pressure in these passages.

Air pressure comes out these passages.

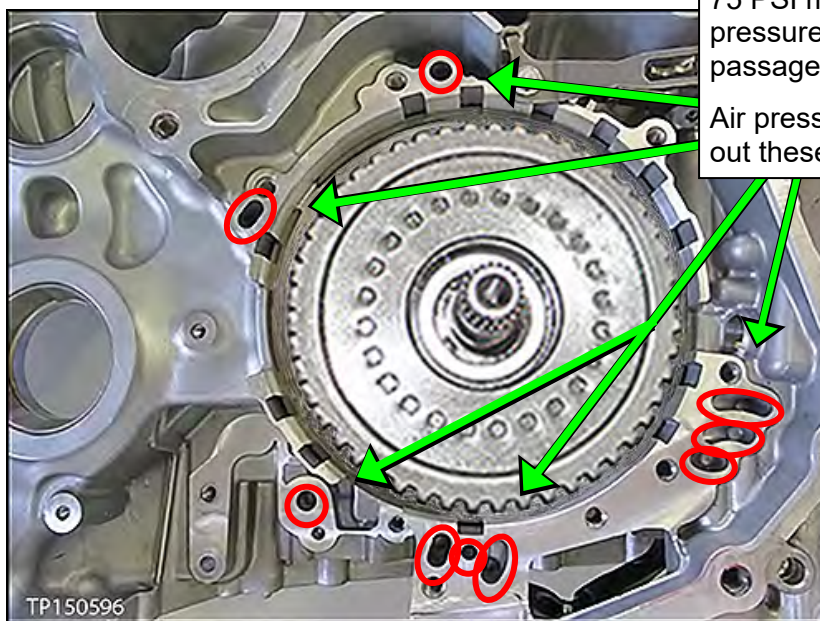

Figure 4D

5. Temporarily install fluid filter cover.

New Oil Pump Installation

IMPORTANT: For the following service procedures a **PARTS KITS REFERENCE TABLE** is provided on page 96.

- Use the check off column on the left to ensure the correct new part is installed at each step, and then attach to the repair order.

1. Install the new oil pump using three original Allen-head bolts (Figure 1E).

NOTE:

- Finger tighten the Allen-head bolts at this time.
- Oil Pump kit includes new pump, O-ring and snap ring.

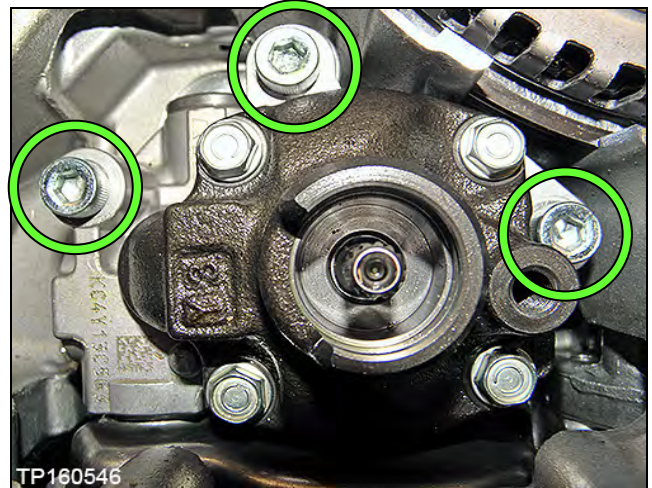

Figure 1E

2. Place new O-ring on the fitting bolt, and coat with CVT fluid (Figure 2E).

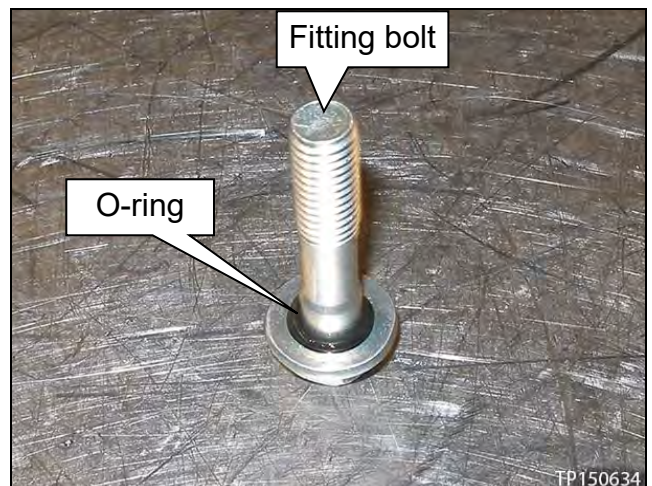

Figure 2E

3. Install the fitting bolt finger tight (Figure 3E).

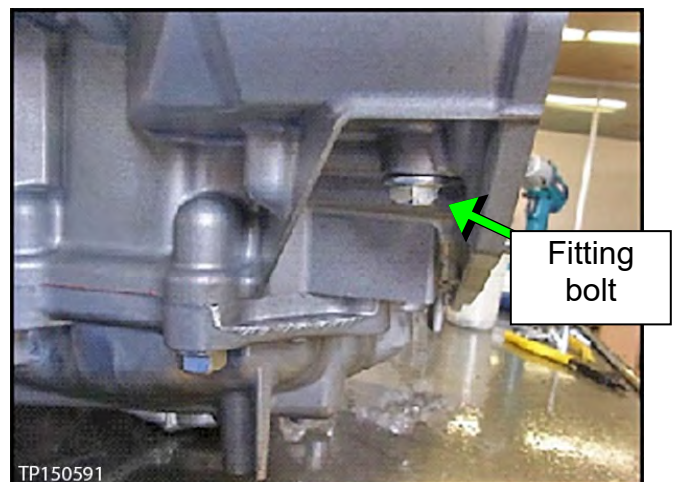

Figure 3E

4. Torque the three Allen head bolts and fitting bolt.
 - Allen head bolt torque: 17.6 – 20.6 N•m (1.79 – 2.1 kg-m, **13.0 – 15.2 ft-lb**)
 - Fitting bolt torque: 26.0 – 30.0 N•m (2.65 – 3.06 kg-m, **19.2 – 22.1 ft-lb**)

5. Install the new snap ring (Figure 4E).

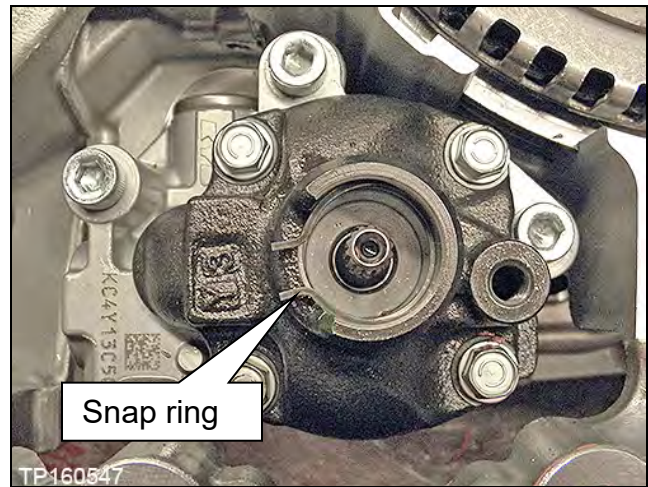

Figure 4E

Replace the Side Cover – Pulleys and Belt (sub-assembly)

Review video # 547: “CVT Belt and Pulley Replacement” and fast forward to minute marker 3:14. This video is located under the **TECH TRAINING GARAGE VIDEOS** tab in Virtual Academy.

1. Temporarily install the dummy cover with 3 bolts, finger tight (Figure 1F).

IMPORTANT:

- Do not install the thrust bearing to the clutch assembly bore at this time.
- If cover does not seat flush see trouble shooting **The Dummy Cover Will Not Sit Flush** on page 91.

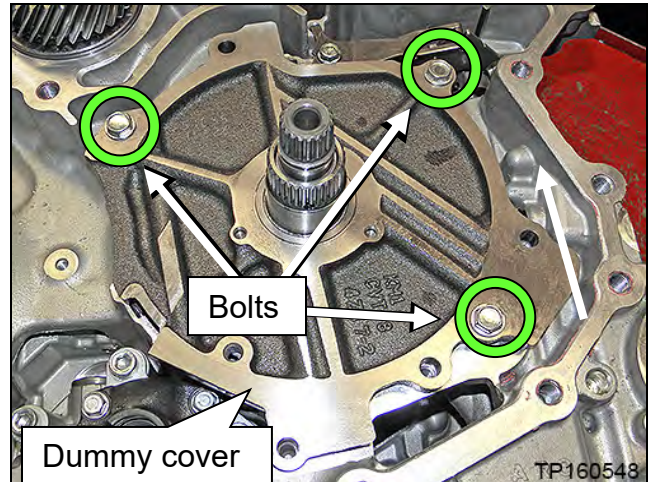

Figure 1F

2. Temporarily install the converter housing onto the CVT case with three bolts finger tight (Figure 2F).

IMPORTANT: When fitting the CVT case surfaces, **DO NOT** use the bolts to draw in the case halves. Make sure the case surfaces are flush, and have no gaps prior to installing the bolts.

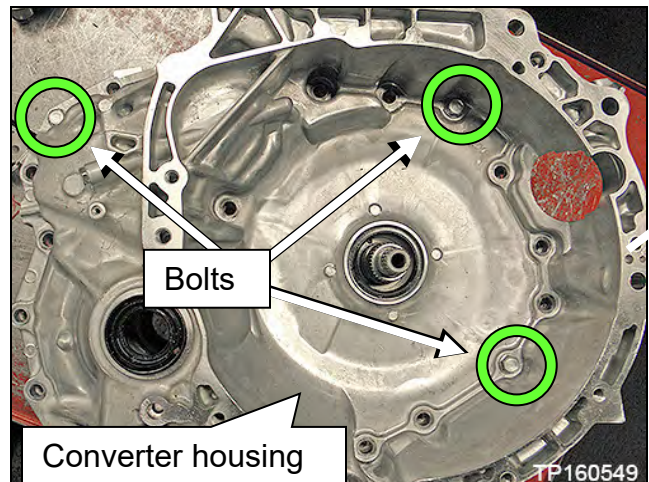

Figure 2F

3. Flip the CVT case so that the converter housing faces down and side-cover faces up.
 - Lifting fixtures J-51595 and J-51595-1 can be used for this step.
 - See Figure 4F for lifting fixture information.

CAUTION:

- Do not hit the manual shaft (Figure 3F) while flipping the CVT; the manual shaft is longer than the oil pan mating surface. Use a plastic / wooden block to support as needed.
- Note the location of the terminal connector harness. Do not pinch the terminal connector harness between the CVT case and work bench or supporting blocks.

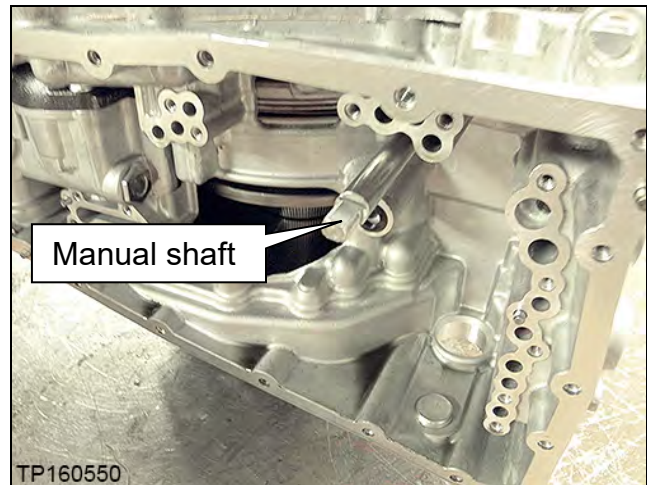

Figure 3F

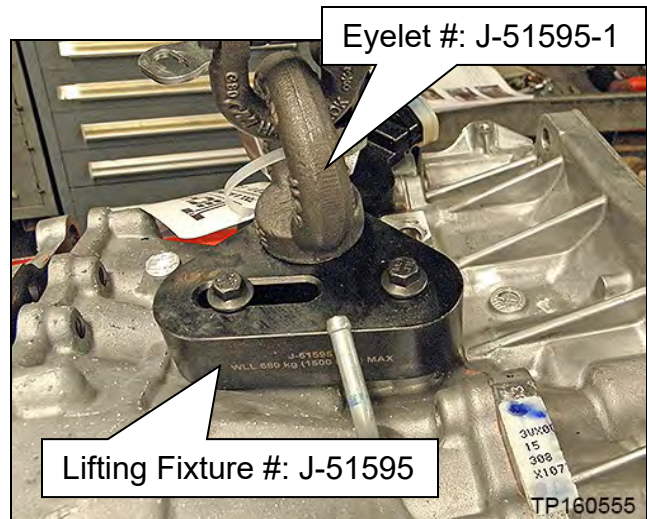

Figure 4F

4. Rotate the primary pulley by hand to check the pulleys rotational characteristics.

IMPORTANT: Remember the pulley's rotational characteristics. This will be used as a reference after the new side cover-pulleys and belt sub-assembly (sub-assembly) have been installed.

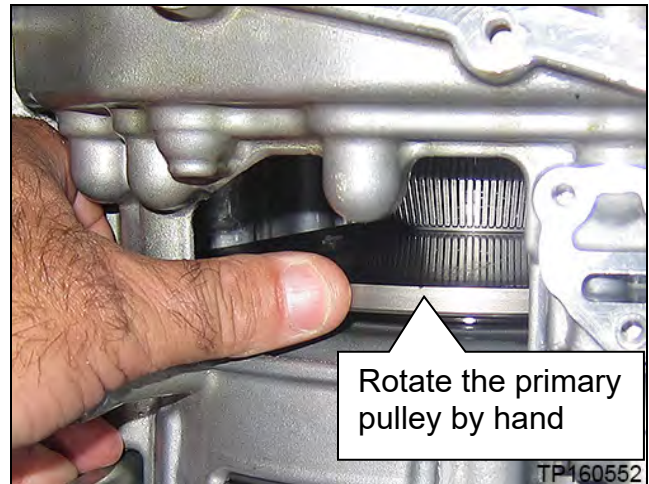

Figure 5F

WARNING: Do not place fingers between the pulley and the CVT case.

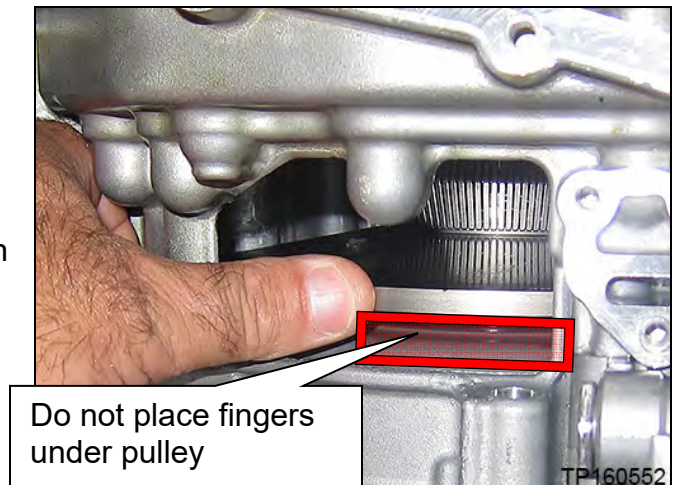

Figure 6F

5. Remove the nineteen (19) side cover fixing bolts (Figure 7F).
 - These bolts will be replaced with new ones and will not be reused.

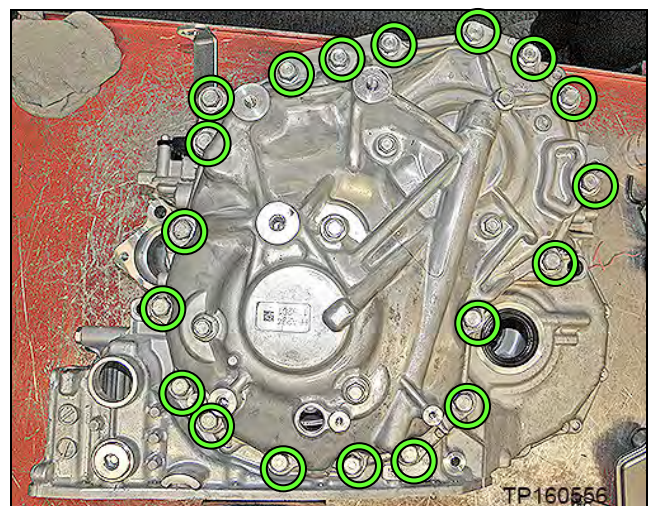

Figure 7F

NOTE: When working with sub-assembly install, uninstall, and bracket attachment, it is critical that CVT and sub-assembly are level. If not level, the pulleys and bearings can sit slightly at an angle and will hinder installation.

6. Attach appropriate lifting fixture to the side cover (Figure 8F).
- For Altima, proceed to page 37 for lifting fixture procedure.
 - For Rogue, proceed to step 10 on page 39 for lifting fixture procedure.

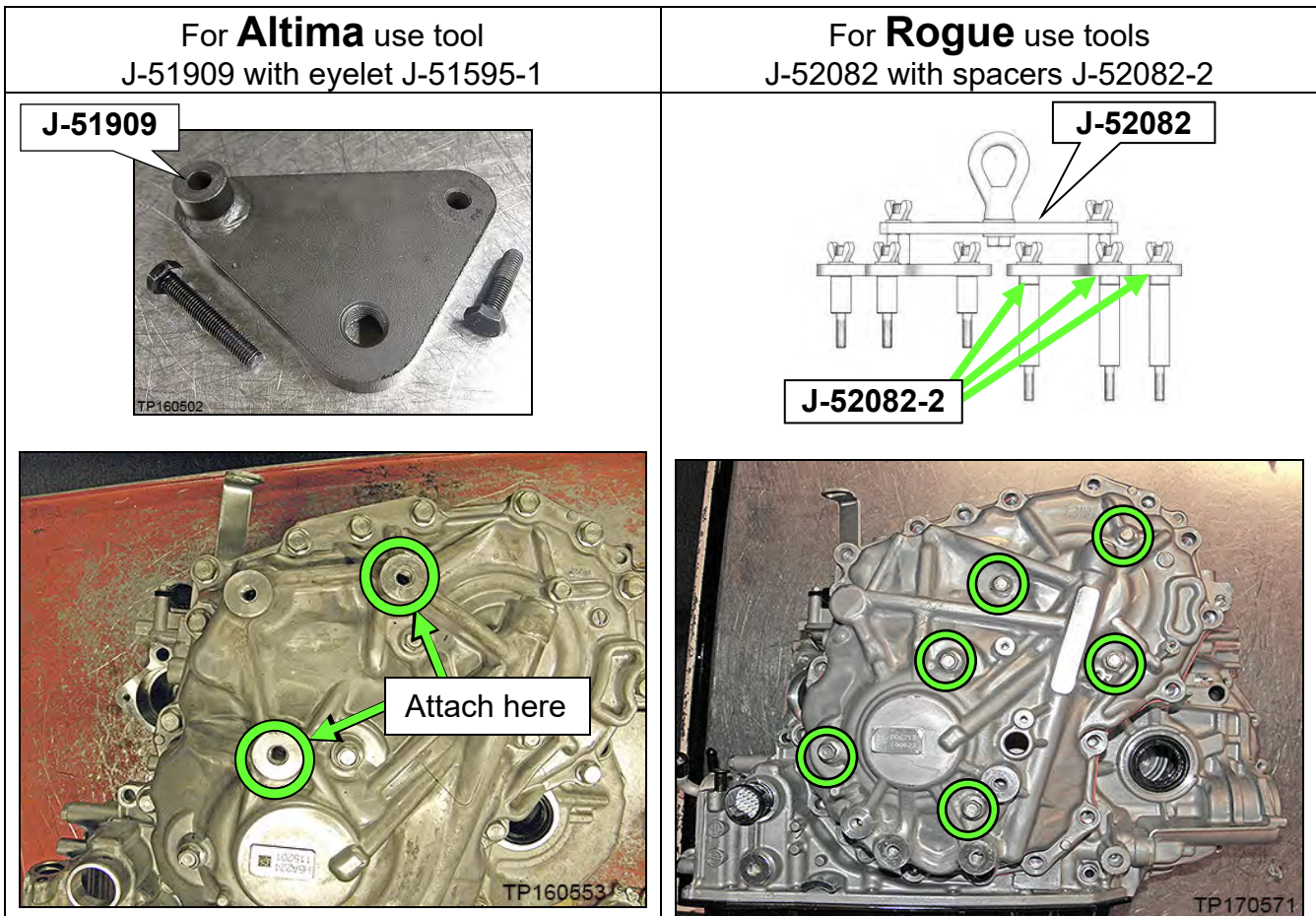

Figure 8F

Altima Lifting Fixture procedure

7. Attach Lifting Fixture J-51909 (Figure 9F) with eyelet from J-51595 (Figure 4F) to the side cover at point shown in Figure 10F.

- Lifting Fixture bolt torque (Max.):
45 N•m (4.6 kg-m, **33 ft-lb**)

CAUTION: Do not cross thread bolts when attaching to side cover.

- Eyelet bolt torque: Hand tight.

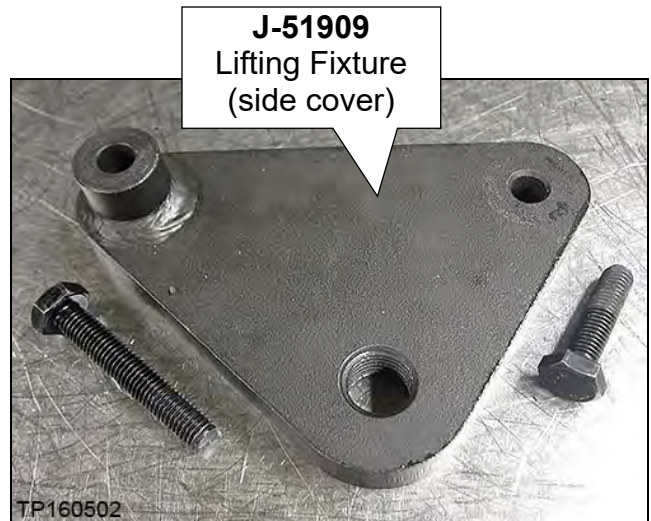

Figure 9F

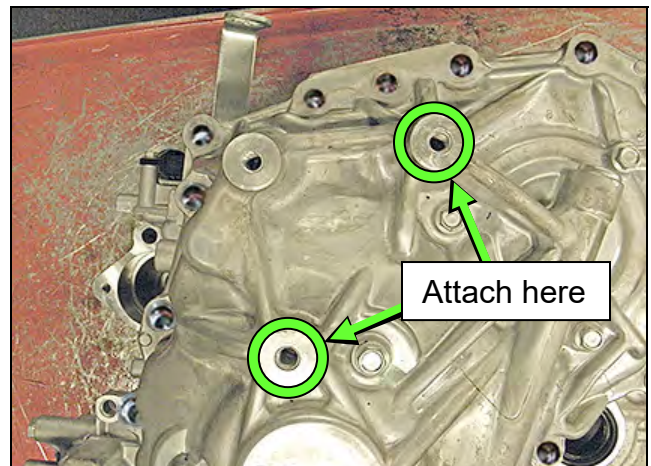

Figure 10F

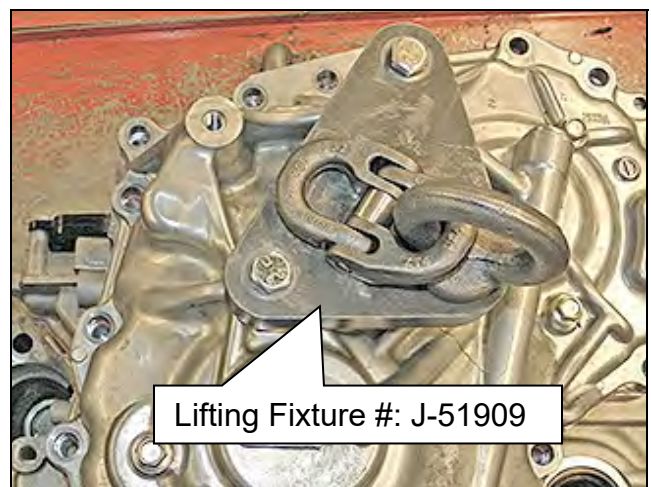

Figure 11F

Altima Lifting Fixture procedure (continued)

8. Install the two alignment Guide Pins (J-51959 - Guide Pins) as shown in Figure 12F and Figure 13F.

NOTE:

- The Guide Pins should be located on opposite sides of the sub-assembly.
- Guide Pins should be placed as far apart as possible.
- Guide Pins must be placed next to dowel pins (Figure 13F).

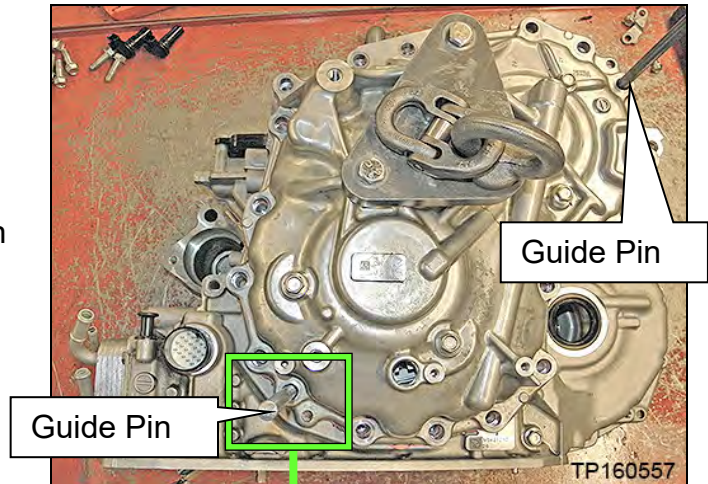

Figure 12F

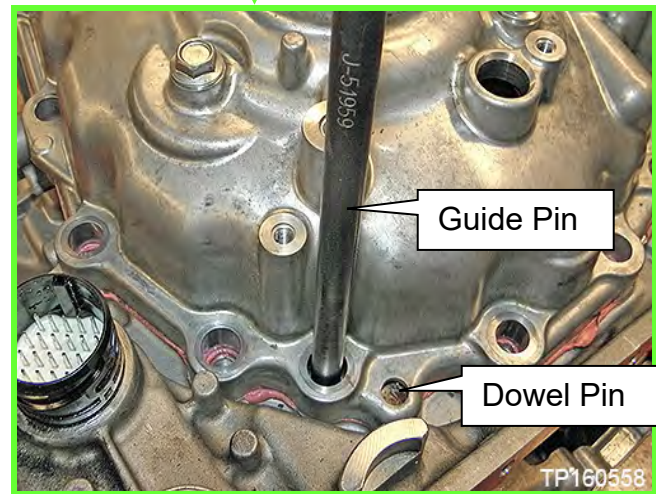

Figure 13F

9. Proceed to step 13 on page 41.

Rogue Lifting Fixture procedure

10. Remove the six (6) pulley bracket bolts.

- Bolts will be reinstalled to the original pulley and belt sub-assembly.

11. Attach universal Lifting Fixture J-52082 with spacers J-52082-2 to the side cover as shown in Figure 15F.

NOTE: Install and tighten by hand only.

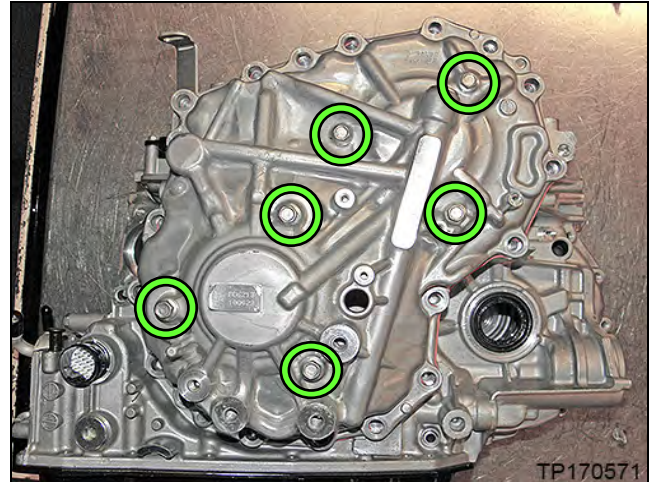

Figure 14F

- Loosen all of the wing-nut bolts on the Lifting Fixture.
- Confirm that three (3) spacers (# J-52082-2) are present between the longer legs and triangle bracket as shown in Figure 15F.
- Install the Lifting Fixture to the CVT case at the six (6) bolt holes shown in Figure 14F.
- Tighten the wing-nut bolts on the Lifting Fixture finger tight in the following order:
 - 1) Tighten the lower six (6) wing-nut bolts.
 - 2) Tighten the two (2) joint to triangle brackets.
 - 3) Tighten the top two (2) wing-nut bolts, and then proceed to step 12 on the next page.

CAUTION: Do not cross thread the bolts when attaching to the CVT side cover.

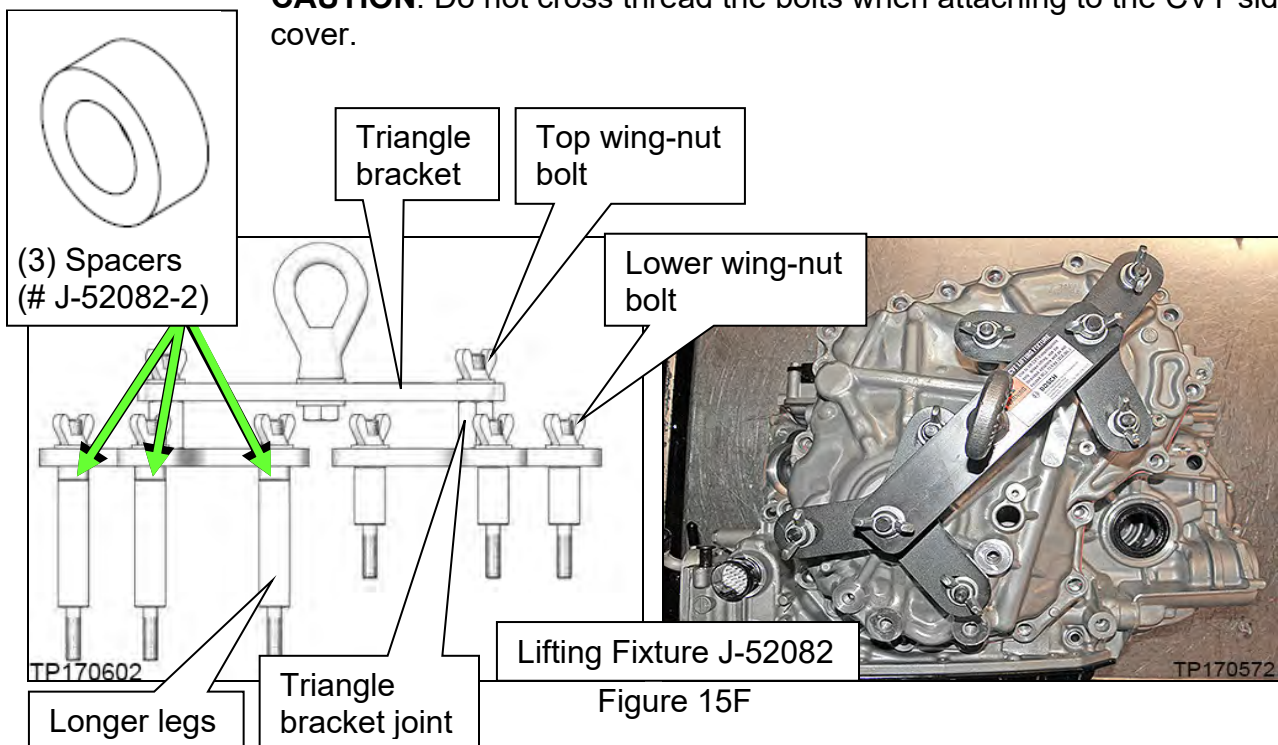

Figure 15F

Rogue Lifting Fixture procedure (continued)

12. Install the two CVT Assembly Guide Pins (J-51959 - Guide Pins) as shown in Figure 16F and Figure 17F.

- The Guide Pins must be located next to the dowel pins.

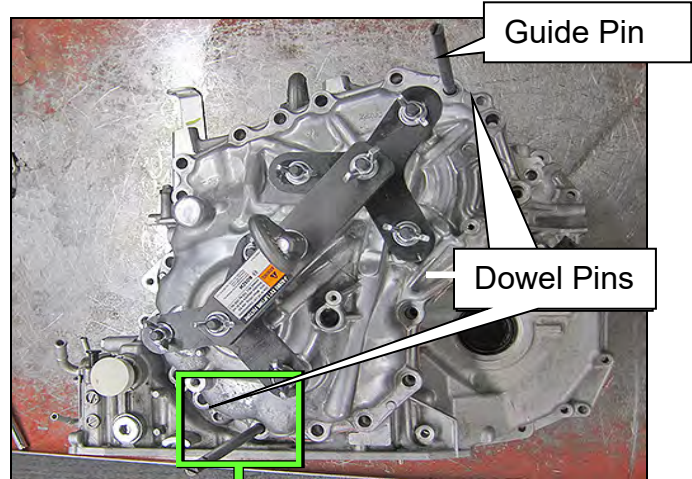

Figure 16F

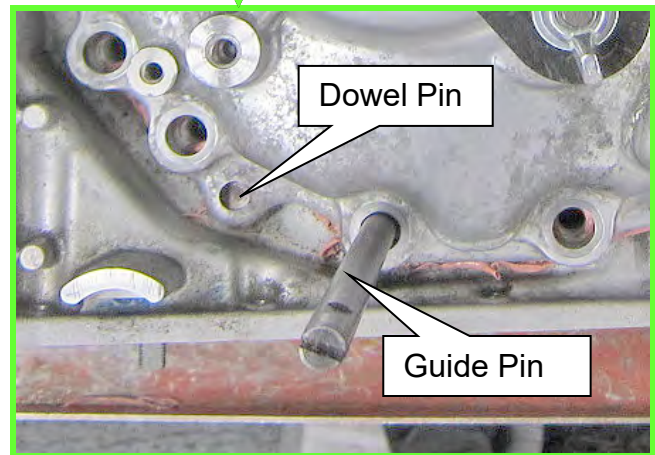

Figure 17F

NOTE: The following steps on the next page apply to both Altima and Rogue.

13. Raise the Lifting Fixture so that the CVT assembly weight is mostly supported by the Lifting Fixture and just slightly raised off of the work surface.

14. Loosen the side cover with a slide hammer at the three points (tool location marks) shown in Figure 18F.

- Rotate between the 3 locations on the side cover until the CVT case separates from the sub-assembly; this can take more than one rotation to loosen sealant.

CAUTION: DO NOT use a pry-bar, chisel, etc. to separate the side cover from the CVT case.

NOTE: Apply rust penetrant to the two dowel pins as needed.

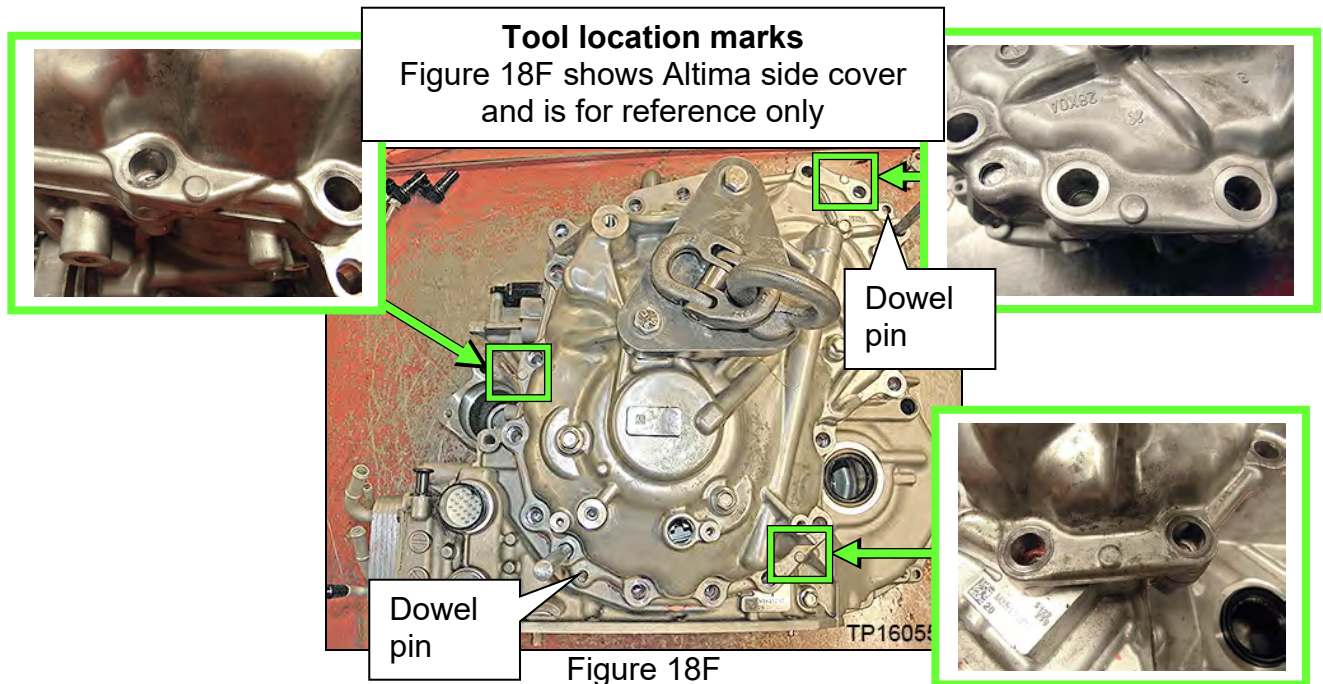

15. Raise the Lifting Fixture to remove the “side cover with pulleys and belt sub-assembly” (sub-assembly) from the CVT case (Figure 19F).

CAUTION: Make sure the primary speed sensor is removed from the sub-assembly.

- Speed sensor will be reused.
- **DO NOT** discard speed sensor.
- This sub-assembly will not be reused.

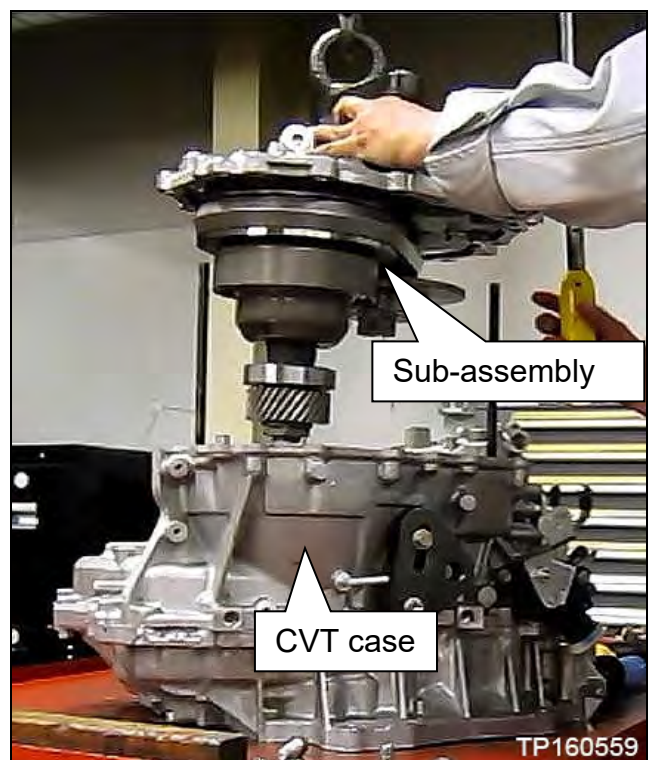

Figure 19F

16. Remove the lifting fixture from the sub-assembly.

- For Rogue re-install all six (6) original bolts into the old sub-assembly.

17. Thoroughly clean the mating surfaces of the CVT case (Figure 20F) that the sub-assembly was just separated from (a plastic scraper can be used).

- Confirm that dowel pins have remained in the CVT case. If not, remove them from the sub-assembly and relocate back to the CVT case.

CAUTION:

- DO NOT use sanding discs, similar abrasive tools, or metal blades.
- Use brake spray or equivalent solvent and lint-free towels only.
- Make sure brake spray or solvents used are compatible with local regulations
- Avoid debris entering into the inside of the CVT.
- Make sure rust and debris have been cleaned off of dowel pins and receiving holes.

18. Replace the O-ring on the CVT case side with a new one from the PARTS KITS REFERENCE TABLE; discard original O-ring (Figure 21F).

- Coat the O-ring with CVT fluid before installing.

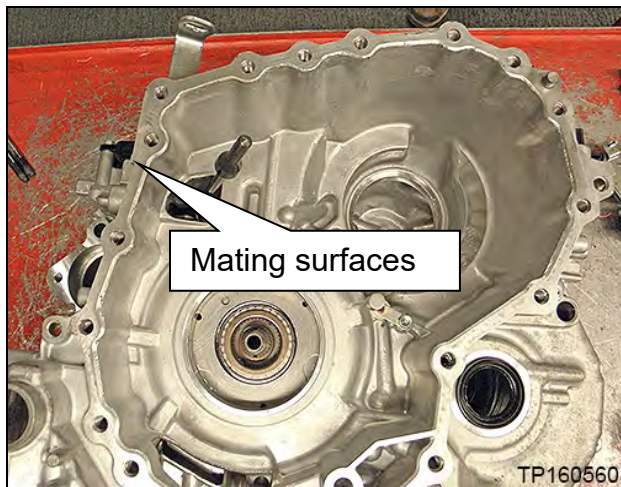

Figure 20F

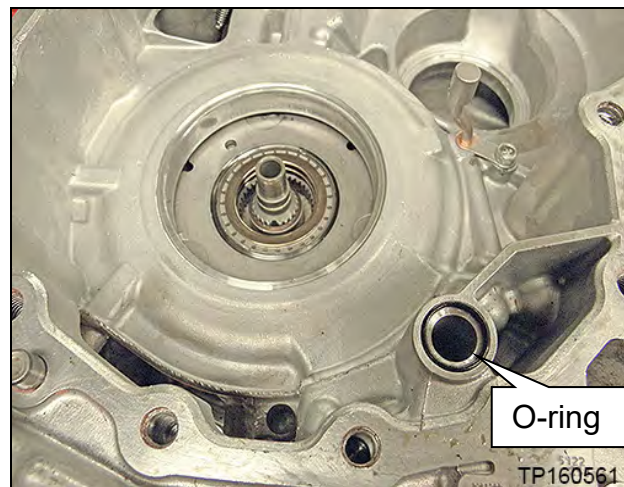

Figure 21F

19. Remove the thrust bearing from the planetary carrier plate (Figure 22F).

- **Thrust bearing will be re-used.**
DO NOT discard.

CAUTION: If not found on the planetary carrier plate, the thrust bearing may still be attached to the primary pulley.

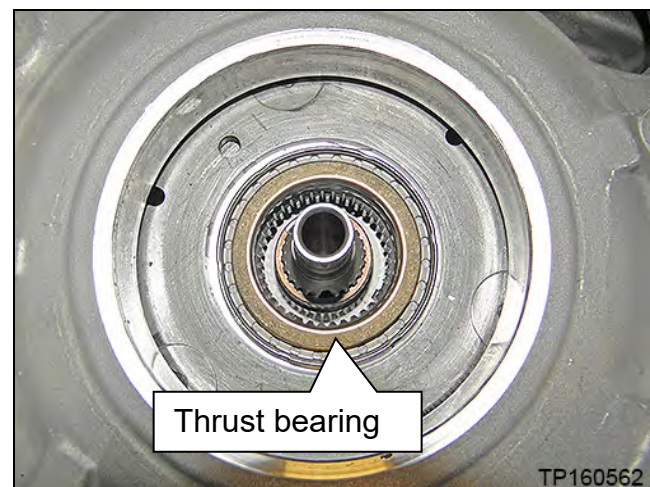

Figure 22F

20. Rotate the shift select lever counter clockwise to the “L” range position (Figure 23F), so that the park pawl is at its lowest position (Figure 24F).

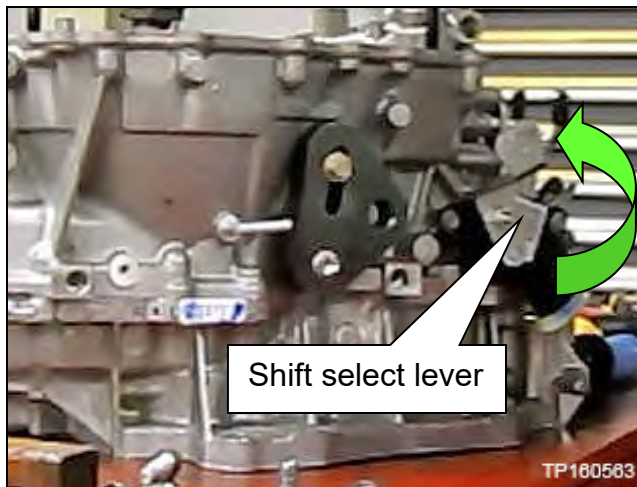

Figure 23F

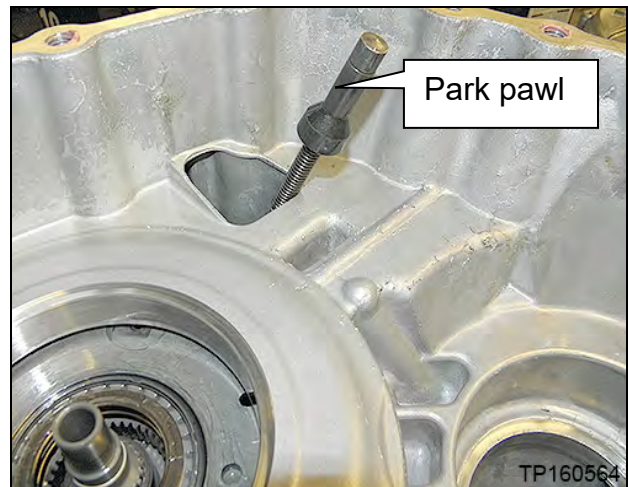

Figure 24F

21. Attach the appropriate Lifting Fixture to the new sub-assembly, and then raise sub-assembly out of the shipping box.

- **For Rogue ONLY**, first remove the six (6) bolts from the new sub-assembly and then remove their O-rings before installing Lifting Fixture.
 - These bolts will be reused.
 - These O-rings will not be reused.

CAUTION: Do not cross thread the side cover holes when installing the Lifting Fixture. Always start the bolts by hand.

- Refer to Altima (page 37) or Rogue (page 39) Lifting Fixture procedures for correct Lifting Fixture installation.

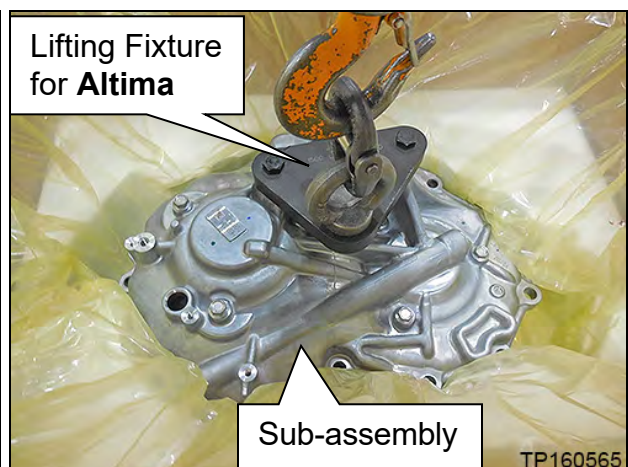
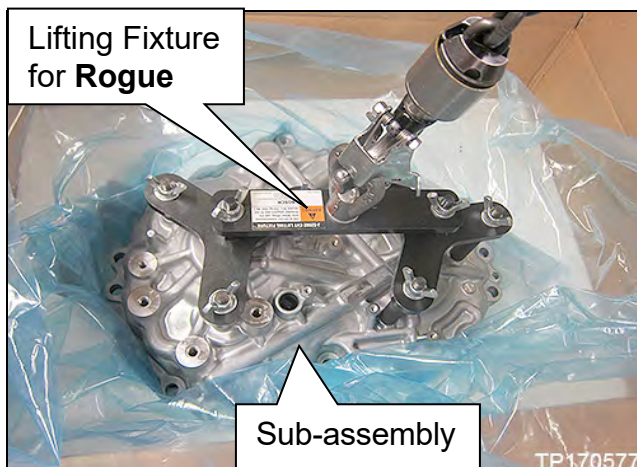

Figure 25F

22. Apply one continuous 2.0 mm diameter bead of sealant along the center of the CVT case side mating surface (Figure 26F).

Sealant:

- Loctite 5460 (See the Parts Information section of this bulletin)
- Color: Pink

IMPORTANT:

- Confirm that the mating surfaces are clean before applying sealant.
- Make sure that the starting point and the ending point of the sealant is between two bolt holes. Overlap both ends of the bead by 3 – 5 mm.

CAUTION: Be careful not to contact or contaminate the sealant. If the sealant has been disturbed or contaminated in any way before case assembly, remove the sealant completely and re-start from step 17 on page 42.

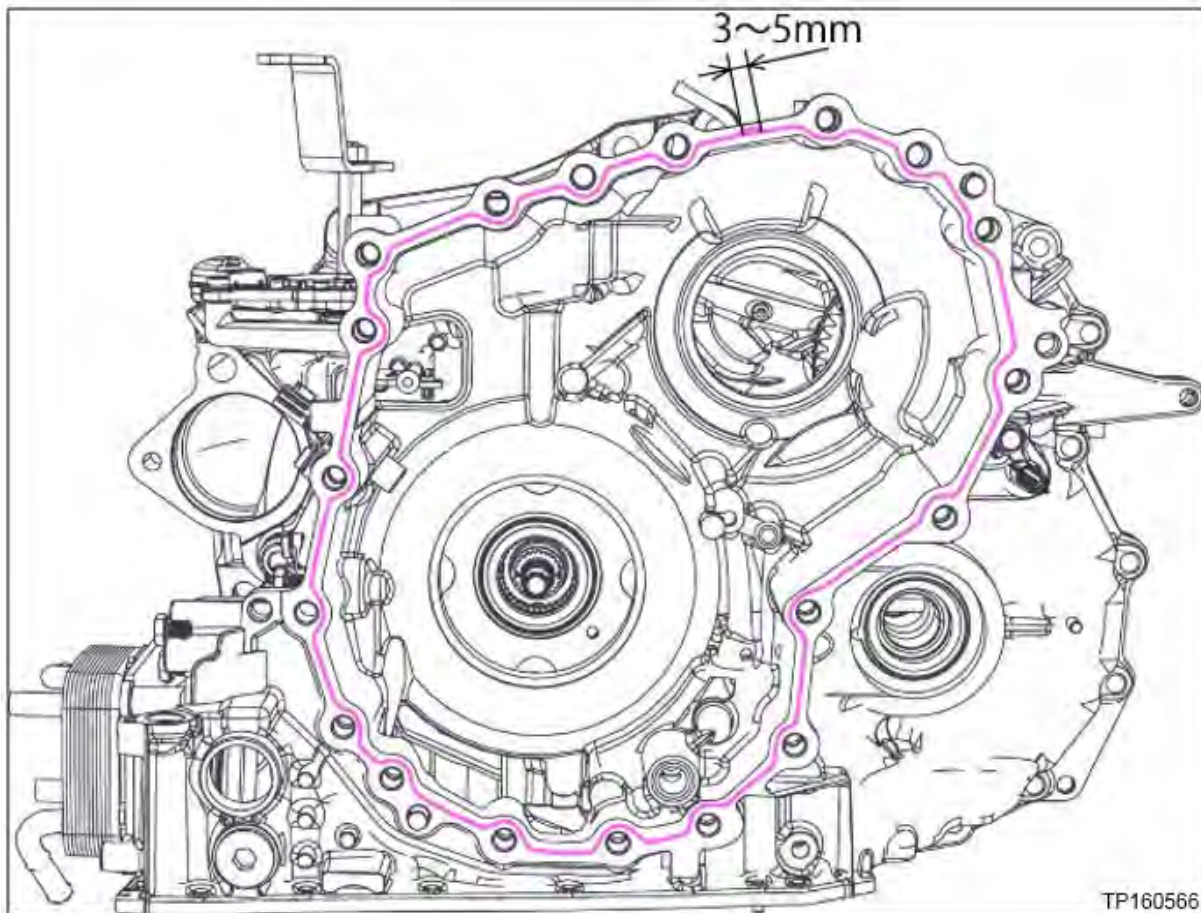

Figure 26F

IMPORTANT: If the Guide Pins were removed to clean the case surfaces, reinstall them now.

23. Install the original thrust bearing on the primary pulley of the new sub-assembly part (Figure 27F).

IMPORTANT: The thrust bearing surface must lay flush with the primary pulley. Any additional height will affect the total end play that is measured later in this procedure.

CAUTION: The thrust bearing has two sides. Reference Figure 27F for bearing orientation.

- Apply a small amount of petroleum jelly or equivalent to the original thrust bearing to hold it in place on the primary pulley.

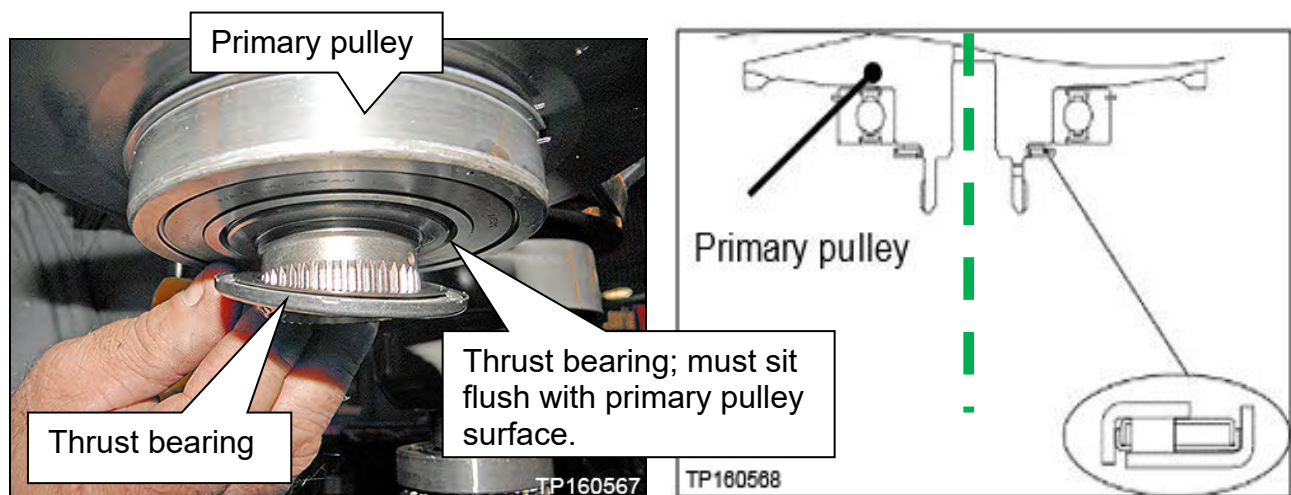

Figure 27F

24. Coat the primary pulley bearing, secondary pulley gear teeth and the secondary bearing with CVT fluid prior to installation (Figure 28F).

CAUTION: Do NOT drip any CVT fluid onto the sealant.

The following Figures are for reference only and may or may not have the sealant in place, or have the old sealant removed. Clean the surfaces and apply sealant when and where instructed.

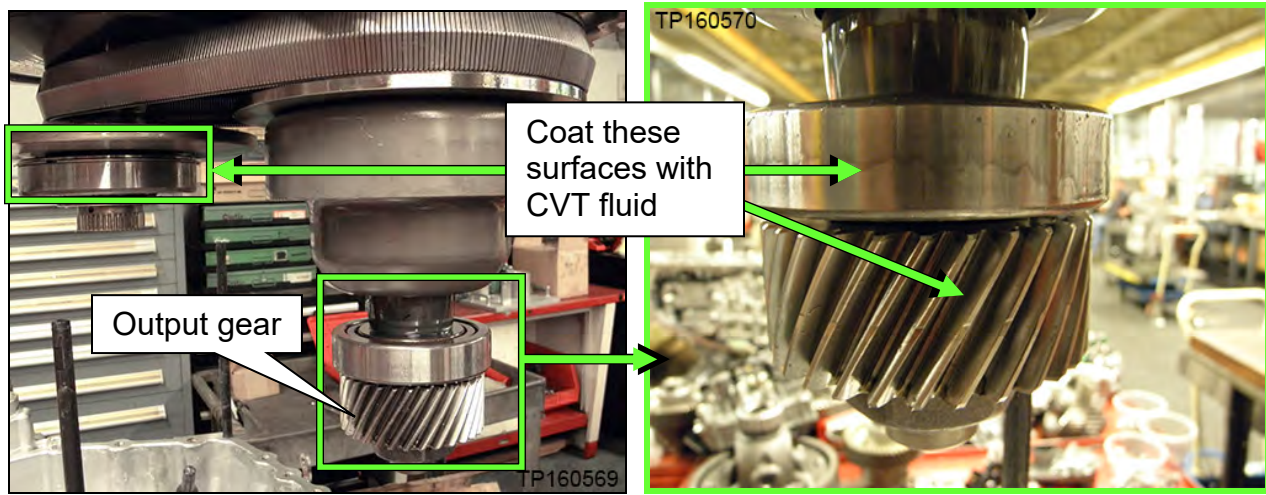

Figure 28F

25. Route the Guide Pins into the appropriate CVT holes one at a time (the Guide Pins are different lengths).

IMPORTANT: Do NOT allow the output gear to contact the lubrication tube when the side cover is positioned over the guide pins (Figure 29F).

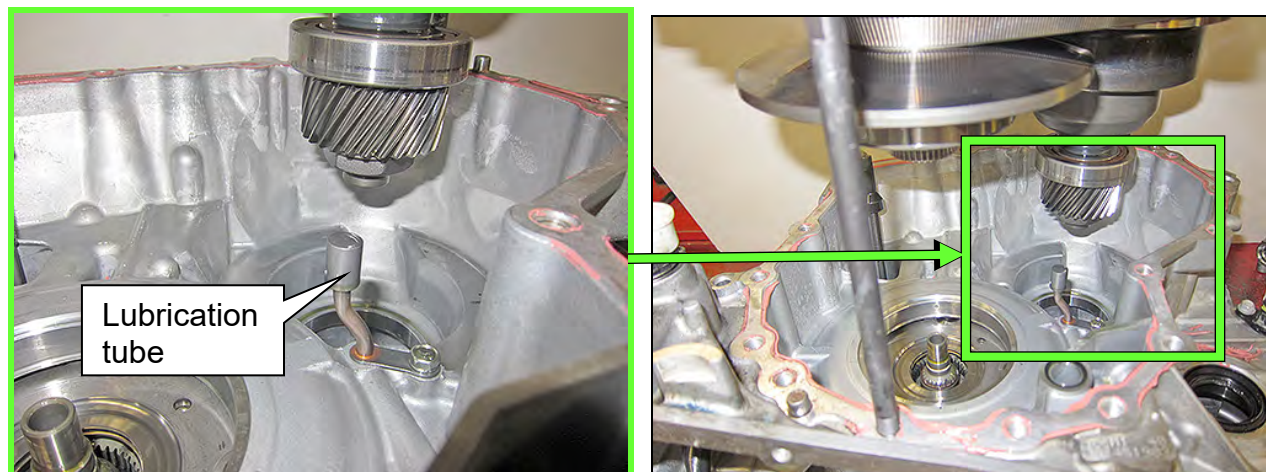



Figure 29F

IMPORTANT:

Before continuing, it is recommended that you review and understand the instructions on pages 47 to 51.

The sub-assembly will lower into the CVT case without applying extra vertical force.

IF THE SUB-ASSEMBLY DOES NOT LOWER COMPLETELY,  ! PHYSICAL INTERFERENCE IS PRESENT.

Key Technique: Raise to remove weight on interference, adjust as necessary, and then lower again.

Use the “visual gap size” below (Figures 30F and 31F), between the sub-assembly and the CVT case, to determine the cause of interference.

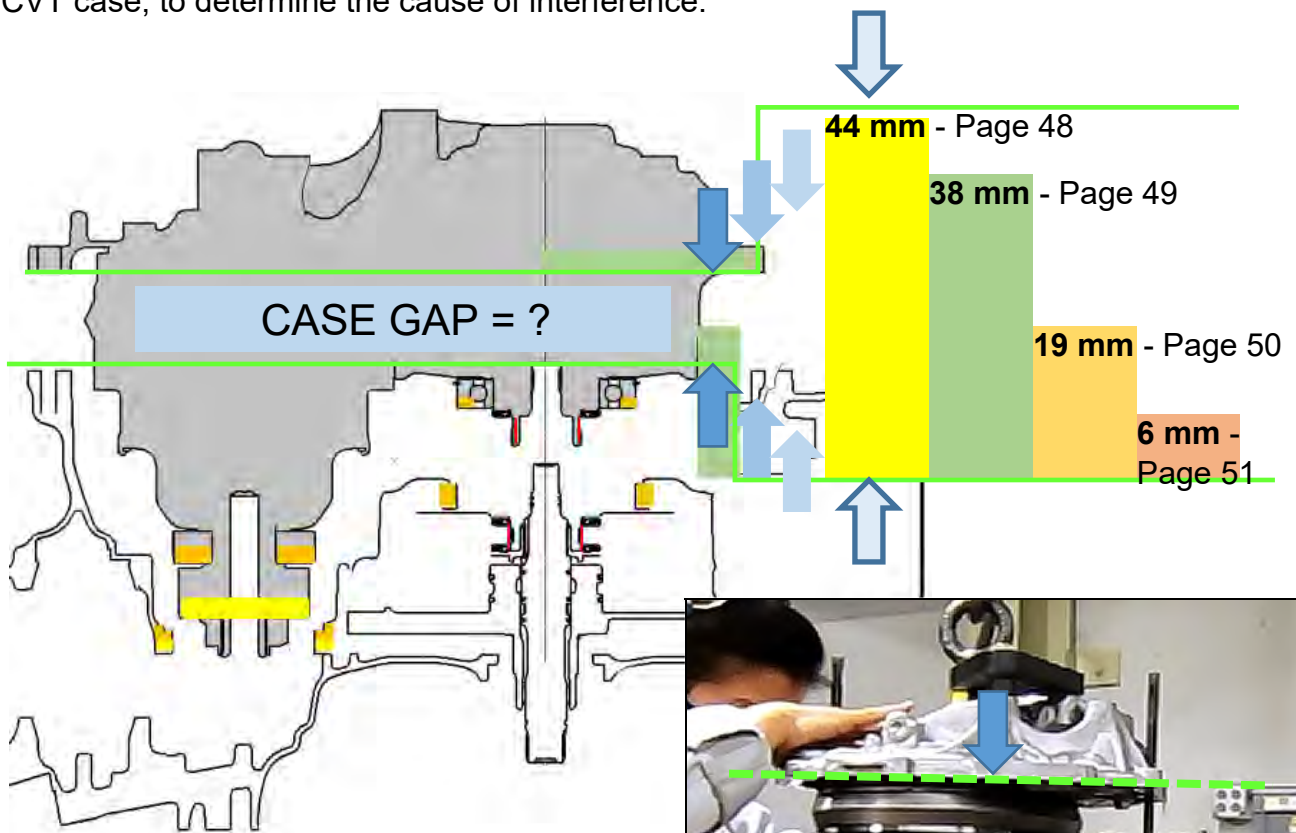

Figure 30F

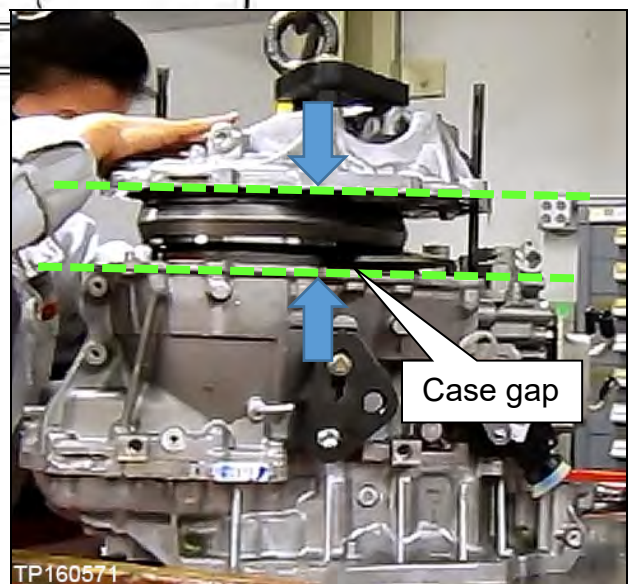

Figure 31F

26. Carefully lower the Lifting Fixture to install the sub-assembly into the CVT case as follows:

- While visually looking down into the bore (Figure 33F) to confirm that the output gear is clearing the CVT case bearing bore,
 - a. Level the sub-assembly by placing hands on top to guide it into the CVT case.
 - b. Lower the sub-assembly until a gap of **38 mm (1.5 inch)** is present to the CVT case (Figure 36F on page 49) and then proceed to step 27.
 - If the sub-assembly will not lower any farther than 44 mm (1.75 inch) the output gear has not cleared the bearing bore (Figure 32F).

Sub-assembly will not lower past 44 mm (1.75 inch)?

- Interference is present between the output gear and bearing bore.

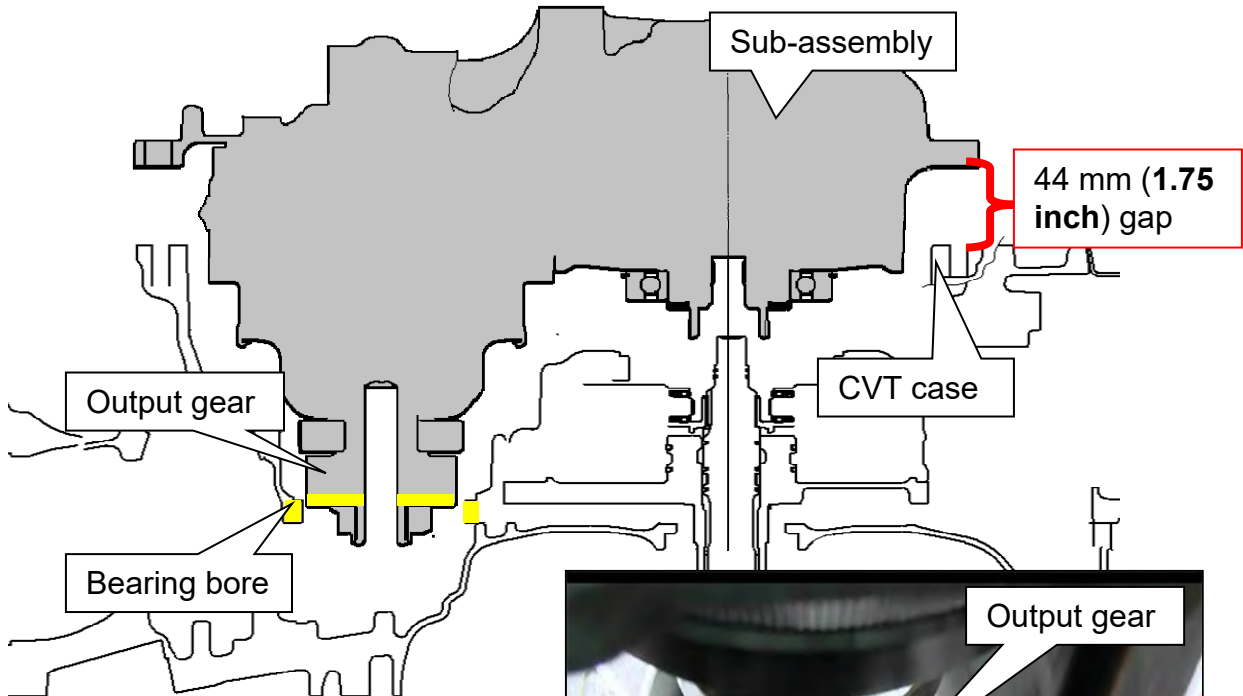

Figure 32F

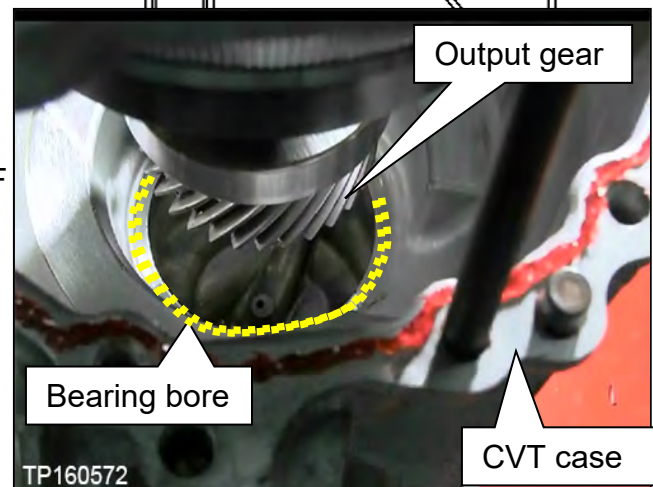



Figure 33F

CAUTION: In the following steps be careful not to contact or contaminate the sealant. If the sealant has been disturbed or contaminated in any way before case assembly, remove the sealant completely and re-start from step 17 on page 42.

27. Align the parking rod with the parking pawl as follows:

IMPORTANT: Perform step 27 while the sub-assembly has a **38 mm (1.5 inch)** gap to the CVT case (Figure 36F).

- a. Rotate the shift select lever clockwise on the side of the CVT to adjust the park rod to the highest position.
- b. Use a magnet, or similar tool, to align the park rod in the CVT case ( in Figure 35F) with the opening in the parking pawl ( in Figure 34F) in the side cover.

NOTE: If the parking rod is not located correctly it will keep the case from lowering.

The following Figures are for reference only.

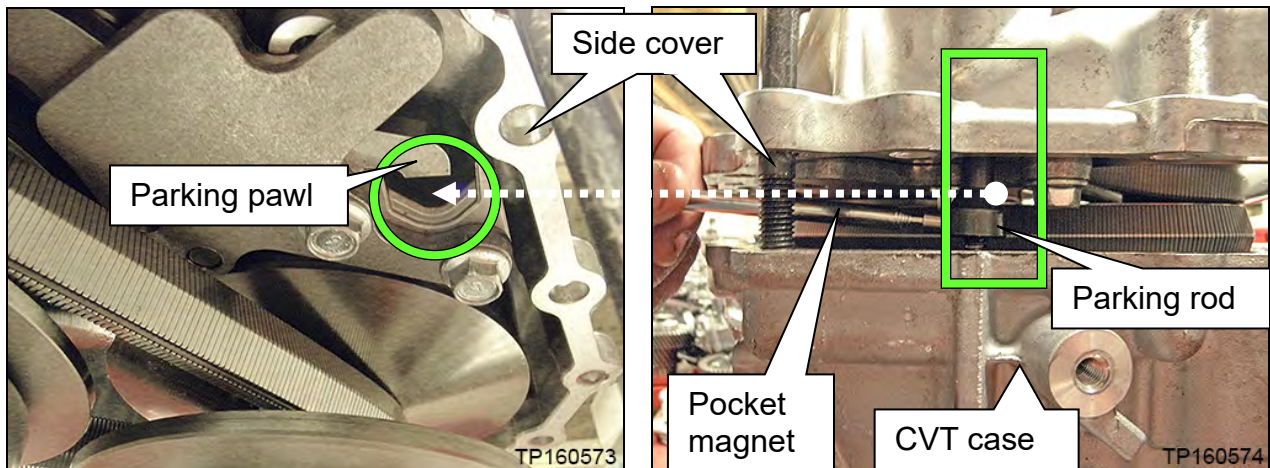

Figure 34F

Figure 35F

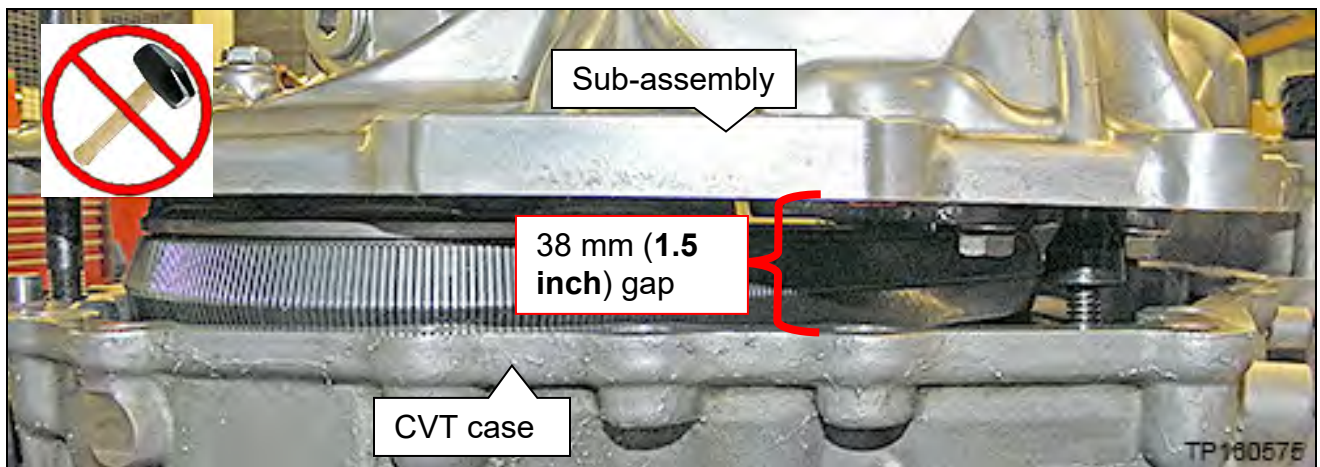

Figure 36F

28. Continue to slowly lower the sub-assembly into the CVT case.

- If the primary and the secondary pulley bearings do not align properly with their bores (Figure 37F) or are at an angle, a **gap of 19 mm (0.75 inch)** may be present.
 - As needed, level the sub-assembly as it is lowered into the CVT case to help the primary and the secondary pulley bearings align in their bores.
 - MINOR LEVELING ADJUSTMENTS with limited weight on the sub-assembly will help the installation. **Vertical force is not needed.**
 - Once the sub-assembly is LEVEL the primary and the secondary pulley bearings will smoothly align while lowering.

Sub-assembly will not lower past 19 mm (0.75 inch)?

- If this occurs Do NOT force sub-assembly into case.
 - a. Raise the sub-assembly slightly.
 - b. Level the sub-assembly (visually check the gap between case and sub-assembly side cover and confirm that it is even all around).
 - c. Gently lower the sub-assembly.
 - d. Gently shake the sub-assembly horizontally, lower, raise and repeat as needed to help align.
 - e. Lower to clear dowel pins to 6 mm (0.25 inch).

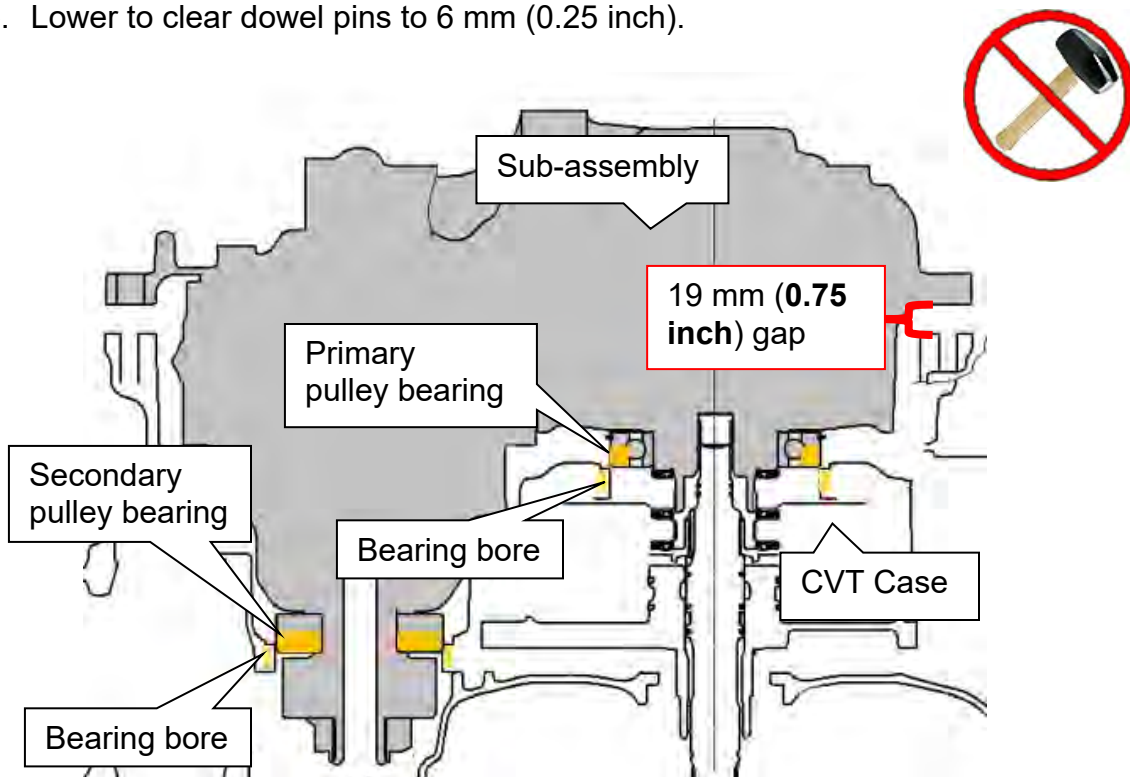

Figure 37F

IMPORTANT: In the following steps the case halves must sit flush against each other without a gap before installing the bolts. The bolts CANNOT be used to draw the cases together. DO NOT APPLY VERTICAL FORCE.

29. Once the dowel pins are cleared, ease the sub-assembly down onto the CVT case until the case halves are flush.

- Confirm the dowel pins are clean and aligned and are not catching on the sub-assembly case cover.

WARNING: Be careful not to get fingers caught between the CVT case and sub-assembly when seating.

Sub-assembly will not lower past 6 mm (0.25 inch)?

If the sub-assembly will not lower past **6 mm (0.25 inch)**, the primary pulley splines are not aligned.

- If this occurs Do NOT force sub-assembly into case.
 - a. Raise the sub-assembly slightly so the weight is not completely on the primary pulley splines.
 - b. Slightly rotate the primary pulley through the bottom of the CVT and then lower the sub-assembly.
 - c. Repeat as needed.

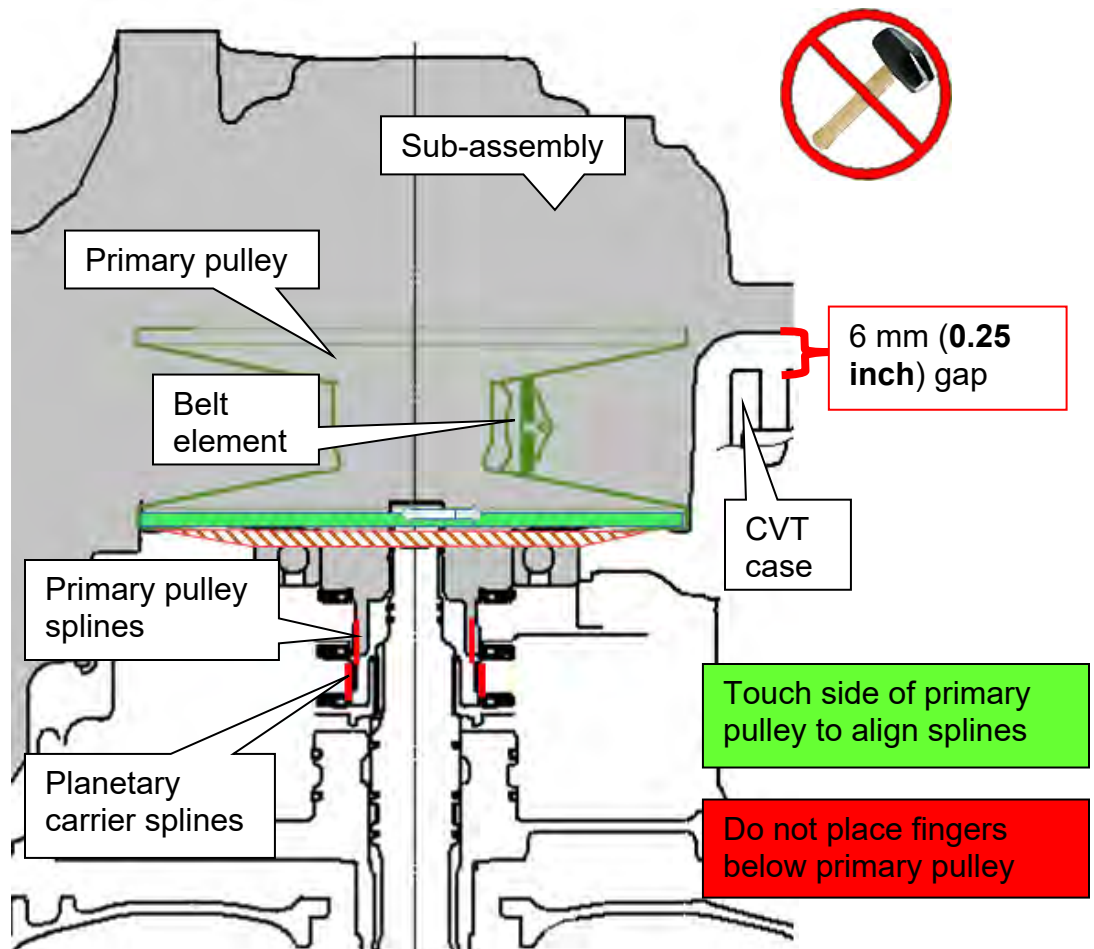

Figure 38F

Rotate the shift select lever

30. Confirm the parking rod operation as follows:

- a. Rotate the shift select lever counter clockwise and confirm that all detents for each of the P-R-N-D-L are felt.
- b. Rotate the lever clockwise to return the rod back to the **P** position.
- c. Are all of the detents felt?

➤ **YES:** Proceed to step 31.

➤ **NO:** If the lever does not rotate or if all detents are not felt:

- 1) Raise the sub-assembly and remove all sealant.
- 2) Restart from step 17 on page 42.

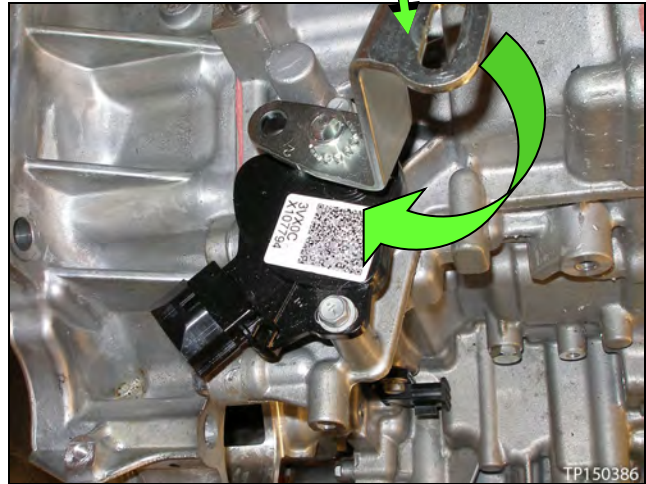

Figure 39F

31. Remove the guide pins.

32. Install the new side cover bolts for sub-assembly to the CVT case (Figure 40F).

- Torque the first eight (8) bolts marked as ● in the sequence numbered in Figure 40F below, and then torque the rest of the bolts in a clockwise manner.
- Bolt torque: 45 N•m (4.6 kg-m, **33 ft-lb**) 19 pieces.

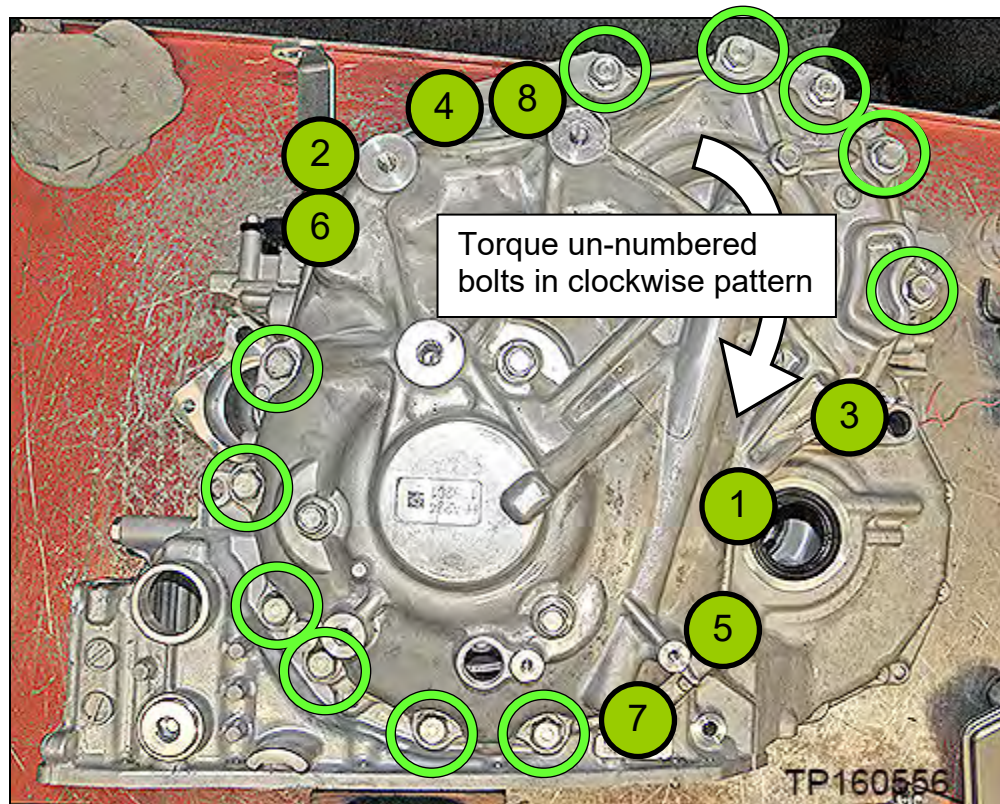

Figure 40F

33. Remove the lifting fixture.

34. For Rogue ONLY, Install six (6) new O-rings, from the Parts Kits Reference Table, to the six (6) new pulley bearing retainer bolts that were removed from the new sub-assembly on page 43, step 21.

- **All other models, proceed to step 36.**

35. Install the six (6) new pulley bearing retainer bolts finger tight.

- Do not use tools to install.

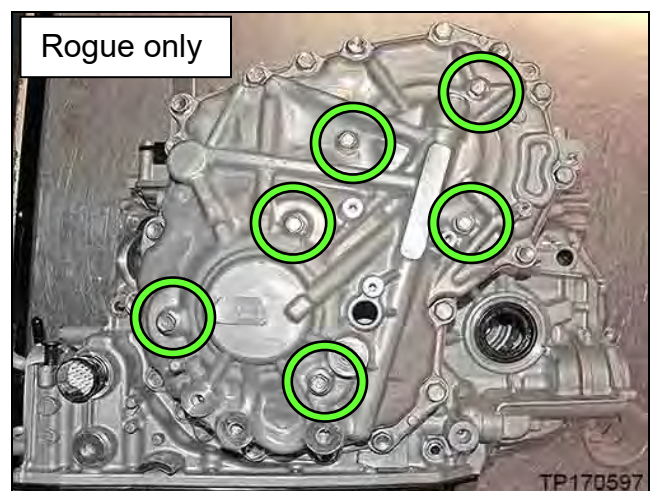

Figure 41F

36. Confirm the rotational smoothness of the primary pulley as follows:

- a. With clean hand, access the primary pulley from the bottom of the CVT.
- b. Rotate the primary pulley by hand and confirm that the characteristic is the same as previously checked at step 4 on page 35, prior to removing the original sub-assembly.
- c. Is the rotational characteristic worse than before the sub-assembly was replaced?
 - **NO:** The rotational characteristic is the same or better; proceed to step 37.
 - **YES:**
 - 1) Remove the sub-assembly from the CVT case.
 - 2) Wipe and clean the sealant completely from both the CVT case rim and side cover rim.
 - 3) Restart sub-assembly installation from Step 17 of “**Replace Side Cover – Pulleys and Belt**” on Page 42.
 - 4) Return to step 36 and recheck rotational characteristic.

37. For Rogue ONLY torque all six (6) bolts.

- **All other models, proceed to step 38.**
- Bolt torque: 28 N•m (2.8 kg-m, **20 ft-lbs**).



Figure 42F

38. Install the CVT case side axle seal (Figure 43F).

- Use Seal Installer J-52281 and Driver Handle J-8092.
- Apply a light coat of CVT fluid to the seal lip surfaces.

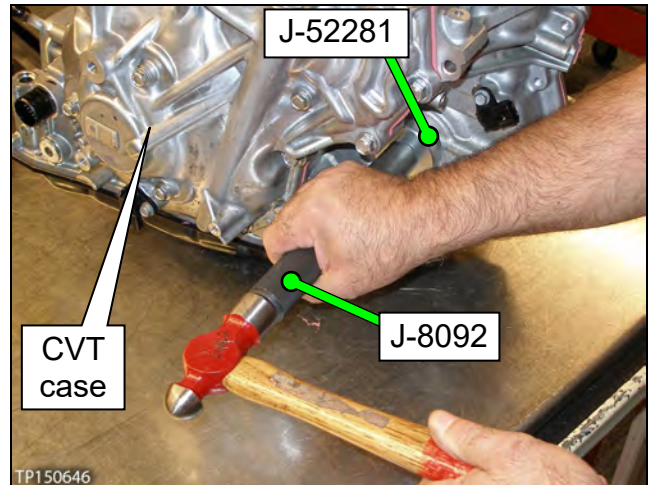

Figure 43F

39. Place the CVT on the work bench with the side cover facing down on the bench.

40. Remove the converter housing which was temporarily installed with three bolts.

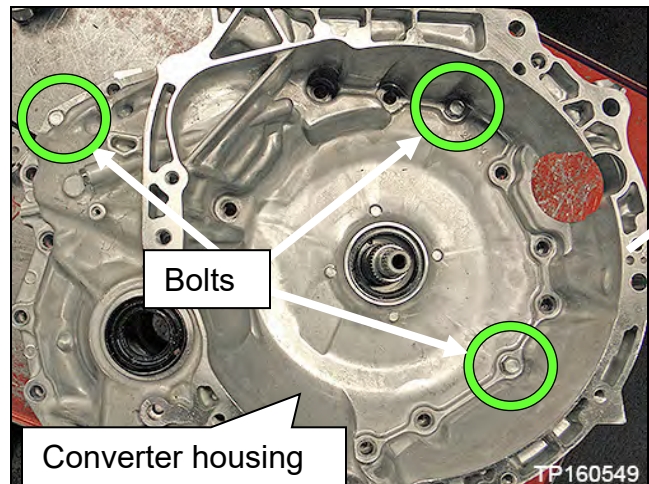

Figure 44F

Clutch Total Endplay Adjustment – Thrust Bearing Selection

IMPORTANT: The clutch total endplay (Figure 1G) must always be adjusted between the clutch drum and the dummy cover when a new sub-assembly is installed and is adjusted with thrust bearing thickness.

There are eight (8) thicknesses of thrust bearing available for total endplay adjustment.

- For additional information, see video # **547: “CVT Belt and Pulley Replacement”** and fast forward to minute marker **13:22**. This video is located under the TECH TRAINING GARAGE VIDEOS tab in Virtual Academy.

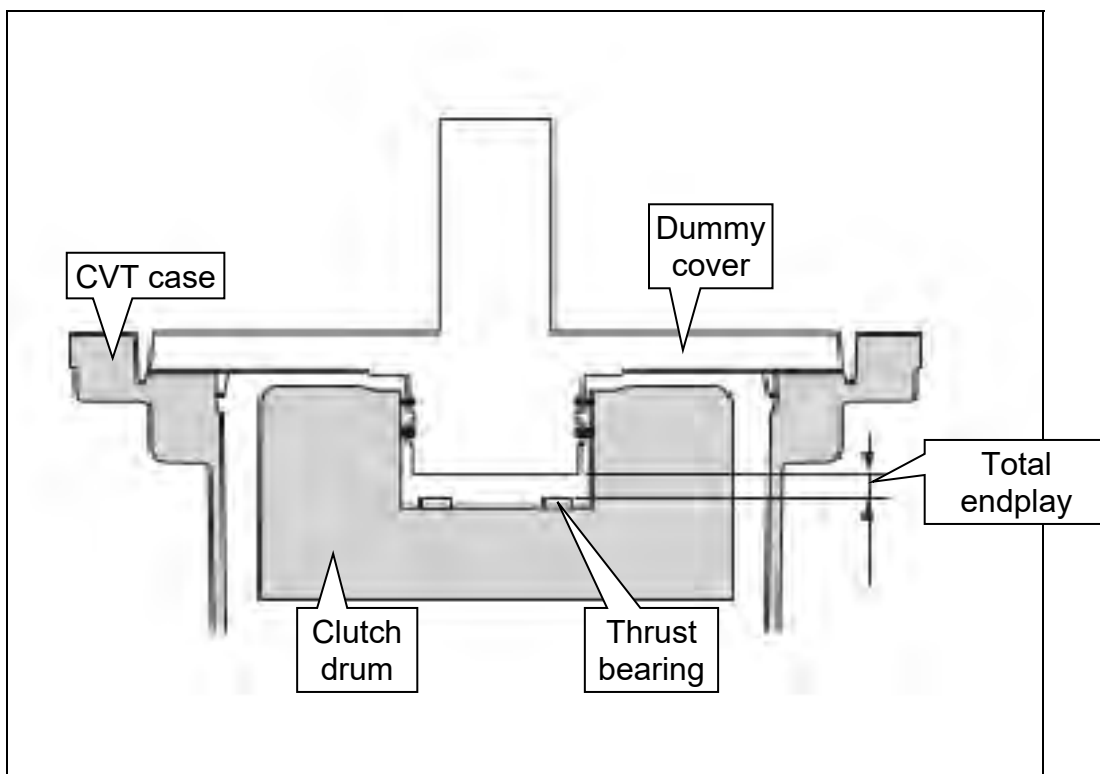

Figure 1G

1. Clean and then zero the Digital Depth Gauge (part #: J-50272).
 - Set Digital Depth Gauge to millimeters.
2. Clean Gauge Block J-50271.
3. Confirm the mating surfaces of the CVT case are clean.

4. Calculate the average (D) clutch assembly bore depth (Figure 2G) as follows:

IMPORTANT: Measurements are required from two opposite ends to obtain the average.

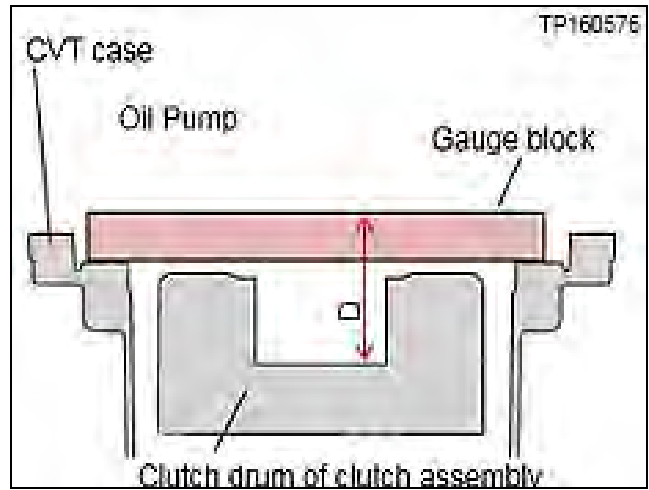

Figure 2G

- a. Position the Gauge Block over the clutch assembly bore on the surface where the dummy cover seats (Figure 3G).

IMPORTANT: This surface is lower than the CVT case to torque converter housing surface.

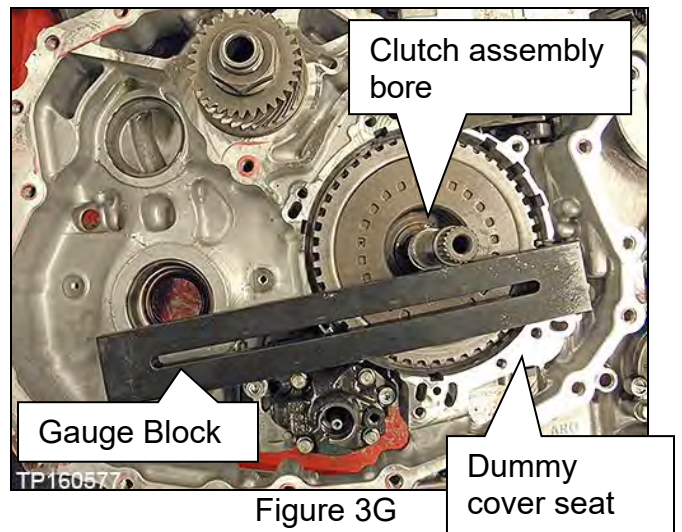

Figure 3G

NOTE: The clutch assembly should sit 2-3 mm lower than the dummy cover seat (Figure 4G).

- b. Confirm the Gauge Block is not sitting on the clutch assembly or against the input shaft.

NOTE: If the clutch assembly is sitting higher than the dummy cover surface, see trouble shooting **The Dummy Cover Will Not Sit Flush** on page 90.

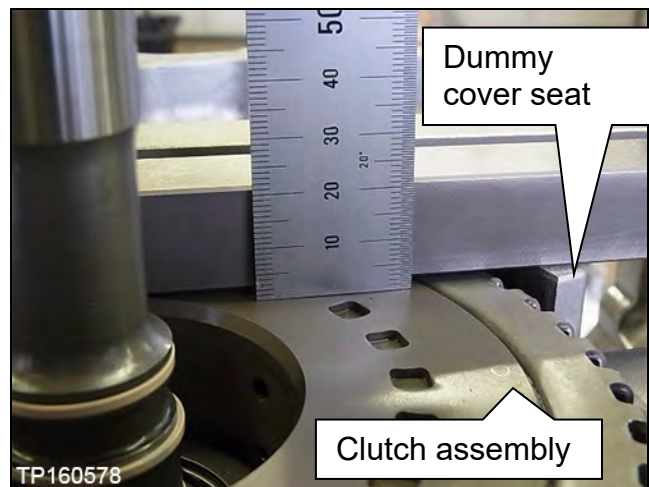

Figure 4G

- c. Position the Depth Gauge on the Gauge Block (Figure 5G).

NOTE: Make sure the Depth Gauge's datum level is flush with the top of the Gauge Block.

- d. Carefully slide the gauge down until it bottoms out on the bottom of the clutch assembly bore. Write this measurement as **D1** (use millimeters).

NOTE: Do not measure from the clutch assembly bore shown in red (Figure 6G).

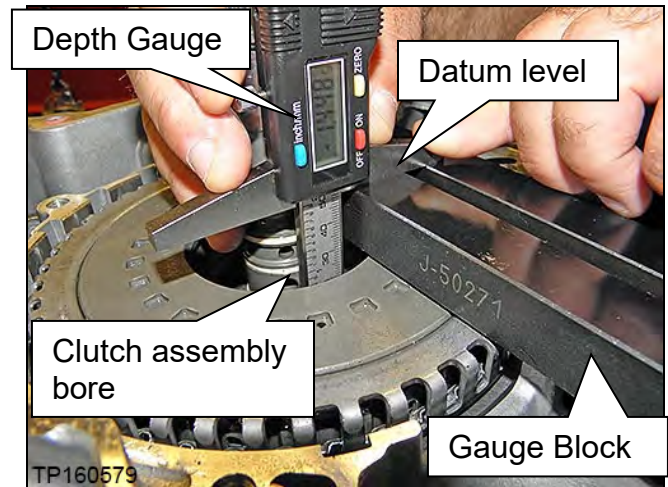

Figure 5G

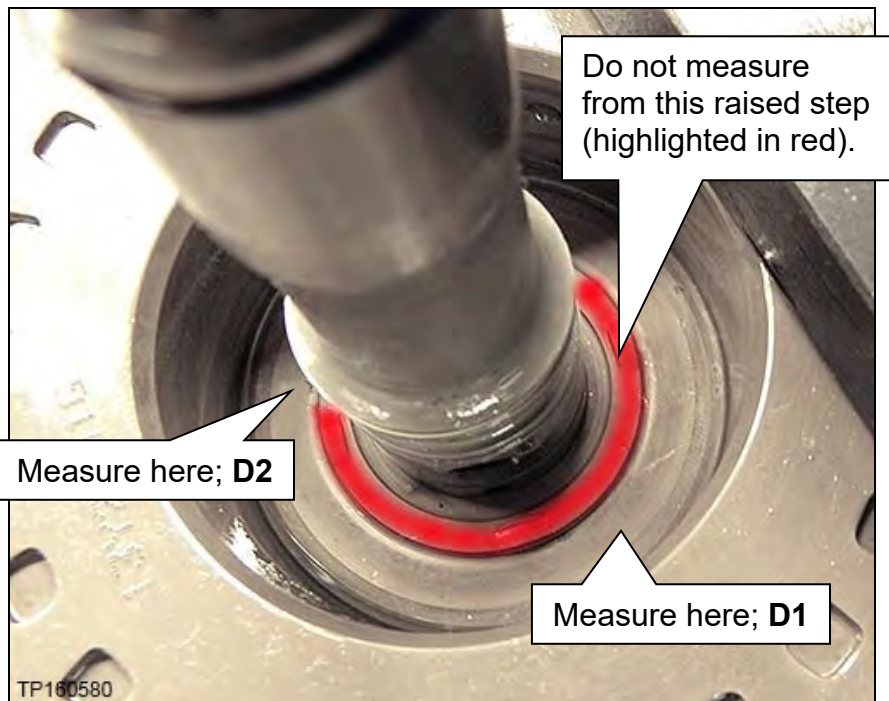

Figure 6G

- e. Measure this same distance on the opposite side (180 degrees) of the clutch assembly bore and write it as **D2**.
- f. Using the formula below, calculate the average and write down the calculated value as **D**.

$$D = \frac{(D1 + D2)}{2}$$

Write the measurement for "D" here _____ mm

5. Measure the average (**H**) dummy cover height (Figure 8G) as follows:
 - a. Clean the dummy cover surfaces that contact the CVT case and thrust bearing (Figure 7G).

CAUTION: Use brake spray (or equivalent) and lint-free towel only. Make sure the brake spray or solvents used are compatible with local regulations.

- b. Place the dummy cover upside down on a work bench, and place the Gauge Block onto the thrust bearing surface (Figure 8G).

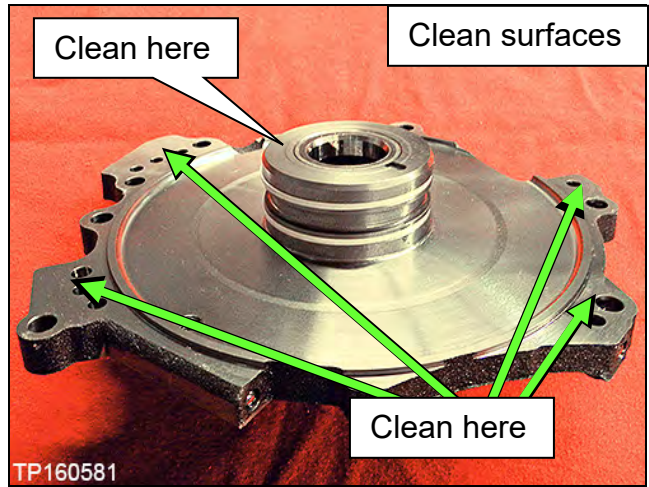

Figure 7G

- c. Position the Depth Gauge on the Gauge Block over an outer end of the dummy cover (Figure 8G).

NOTE: Make sure the Depth Gauge's datum level is flush with the top of the Gauge Block.

- d. Carefully slide the Depth Gauge down until it contacts the dummy cover surface that mates with the CVT case. Write this measurement as **H1** (use millimeters).
 - e. Measure this same distance on the opposite side of the dummy cover and write it as **H2** (Figure 8G).

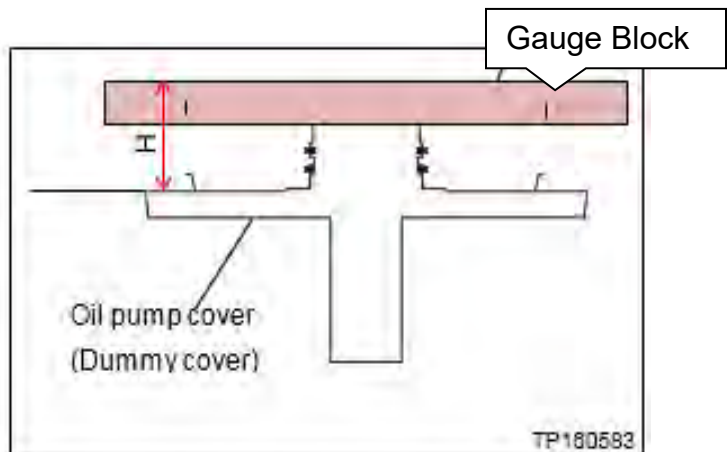
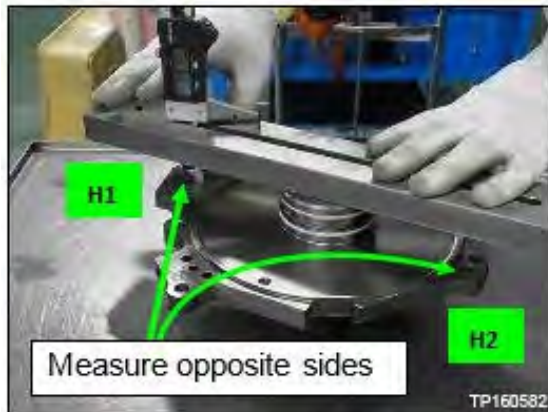

Figure 8G

- f. Using the formula below, calculate the average and then write down the calculated value as **H**.

$$H = \frac{(H1 + H2)}{2}$$

Write the measurement for "H" here _____ mm

6. Choose the thrust bearing to adjust Clutch Total Endplay (**A**) as follows:

- a. Calculate **A** (Total Endplay):

Total Endplay A = D – H (This will be the thrust bearing thickness).

- Fill in the measurements below for "D" and "H" from pages 58 and 59 to calculate for "A".

D measurement _____ mm
 – **H** measurement _____ mm
 = **A** _____ mm

Please print this page and attach it to the repair order.

- b. Choose the appropriate bearing from the table below, based on **A** (eight different thicknesses of thrust bearings are available).

Example: If **A** = 4.3 mm, it falls between the lower and upper clearances for bearing thickness 3.93 mm.

 - Refer to **PARTS INFORMATION** for Thrust Bearing part numbers by thickness.
- c. Measure and confirm that the selected thrust bearing is the correct thickness before installing (Figure 9G).
- d. Circle the thrust bearing part number that was selected in Table A.

Table A

PART #: 31407-	A = D - H CLEARANCE (A)	BEARING THICKNESS
1XZOB	3.87 - 4.07 MM	3.57
1XZOC	4.08 - 4.23 mm	3.75
1XZOD	4.24 - 4.43 mm	3.93
1XZOE	4.44 - 4.58 mm	4.1
1XZ1A	4.59 - 4.78 mm	4.28
1XZ1B	4.79 - 4.94 mm	4.46
1XZ1C	4.95 - 5.09 mm	4.61
1XZ1D	5.10 - 5.29 mm	4.79



Figure 9G

7. Install the thrust bearing flush to the clutch assembly bore as shown in Figure 10G.
 - Install thrust bearing in area shown in green so that it is centered by the four tabs.

CAUTION: The thrust bearing has two sides. See image below for appropriate orientation.

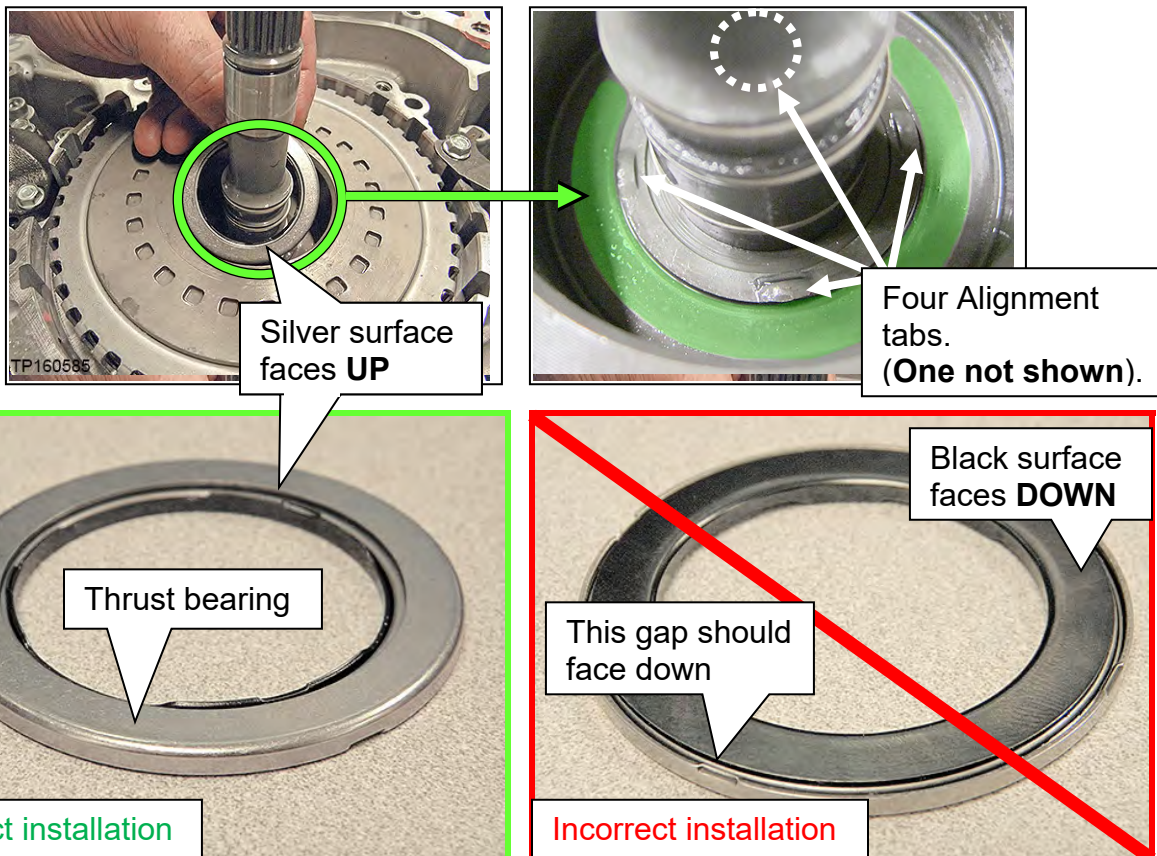

Figure 10G

Clean the Converter Housing Passages

IMPORTANT: Remove as much of the CVT and cleaning fluids as possible, and clean the related parts in the following steps.

1. Remove the baffle plate and lubrication tube as follows:

- a. Remove the three bolts, and then remove the baffle plate from the converter housing (Figure 1H).

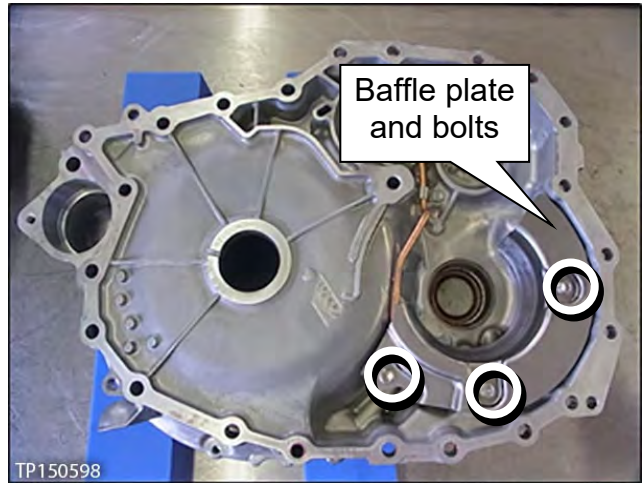

Figure 1H

- b. Remove the bolt and then remove the lubrication tube and its bracket (Figure 2H).

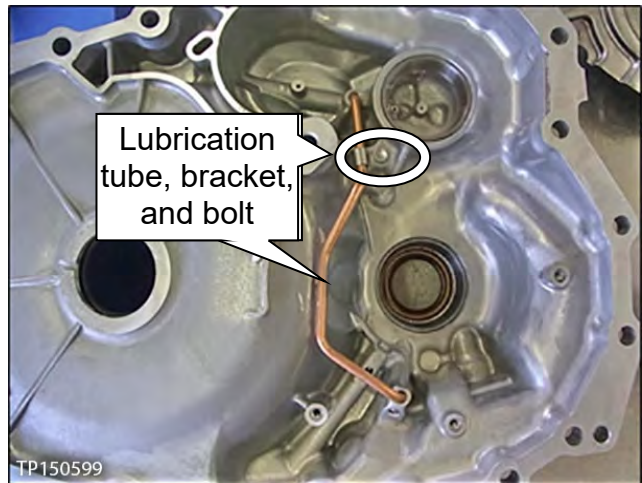
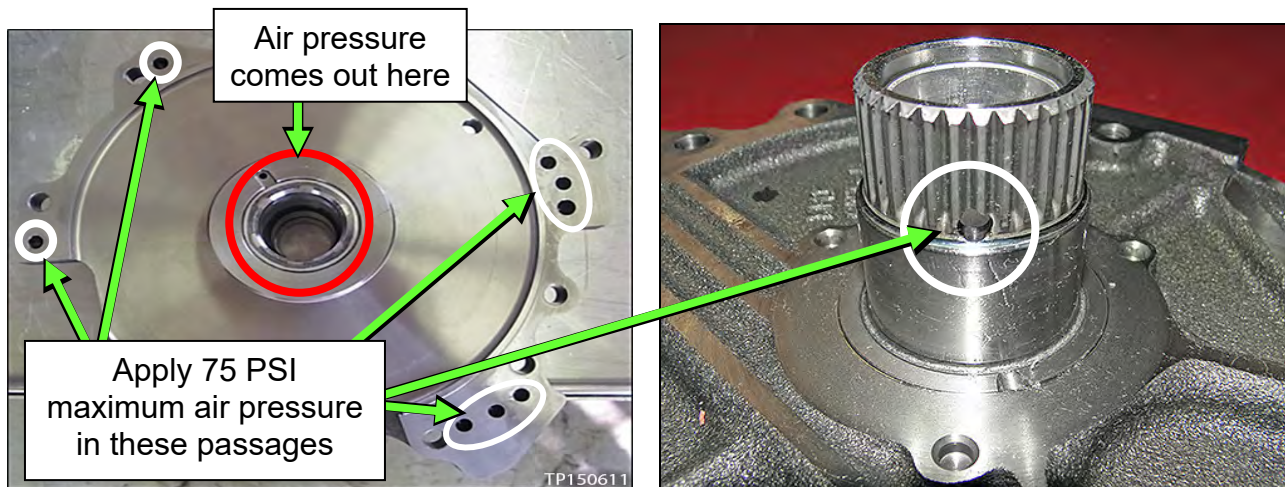
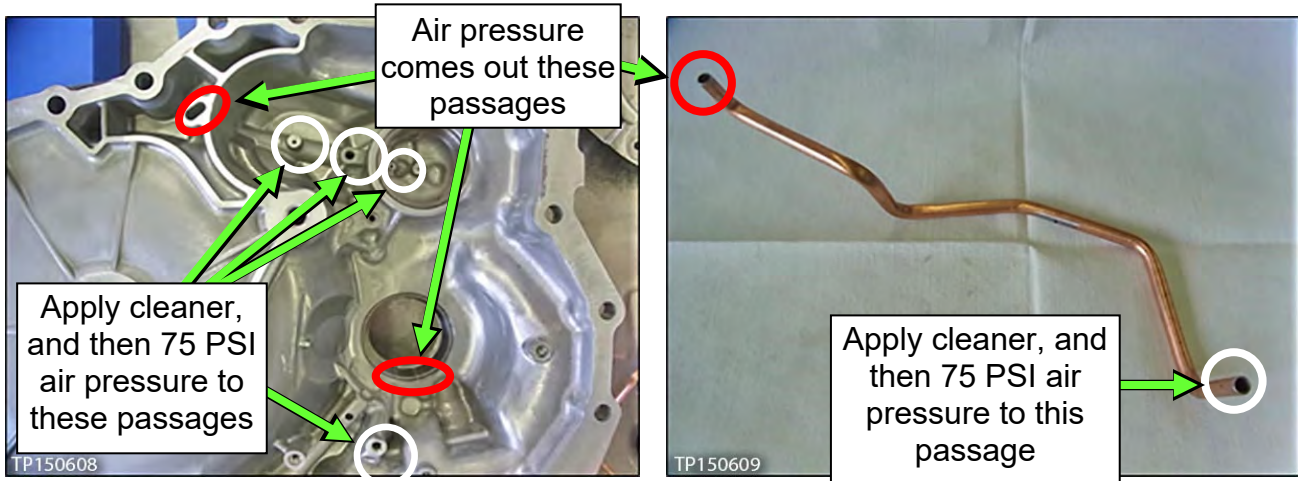

Figure 2H

2. Clean the oil passages of the converter housing, lubrication tube and dummy cover with brake spray (or equivalent) where shown in Figures 3H and 4H below.

NOTE: Do not stand in front of the passages shown while using compressed air.



3. Install the lubrication tube and bracket, and then the baffle plate with three bolts (Figure 5H).

- Bolt torque: 5.9 N•m (0.6kg-m, **52 in-lb.**)

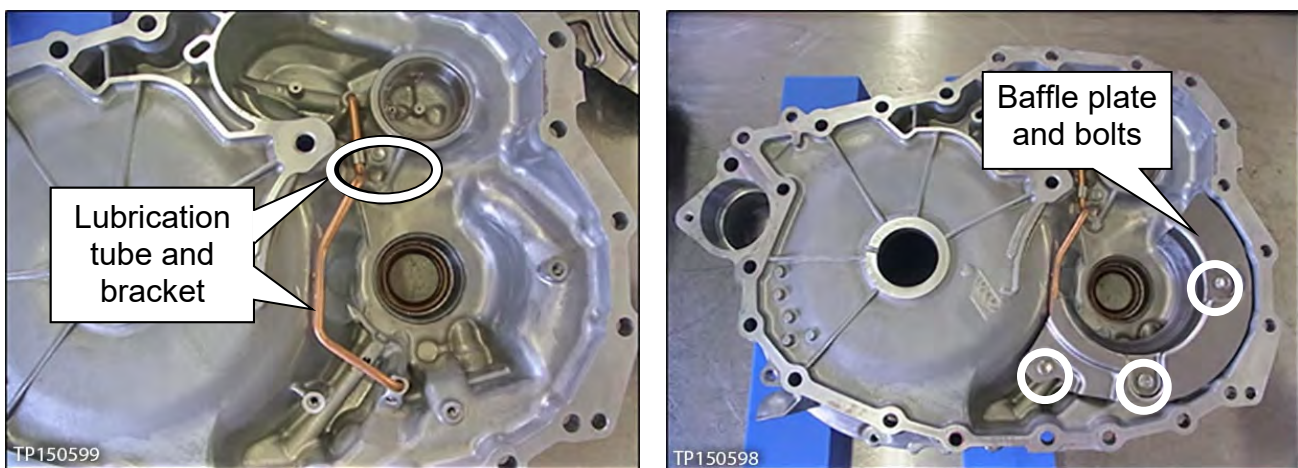

CVT Reassembly

1. Install a new torque converter seal with Seal Installer J-50818 (Figure 11).
 - Place the torque converter housing flat during installation.
 - Apply a light coat of CVT fluid to the seal lip surfaces.
 - The torque converter housing seal will be 0.5 mm (**0.020 inches**) below the bore's surface when the seal installer bottoms out.

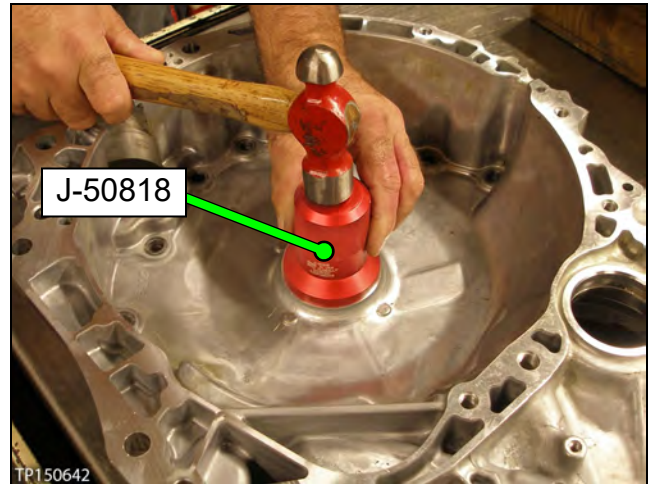

Figure 11

2. Is this vehicle an all-wheel drive (AWD)?

YES: Proceed to step 3.

NO: Install the torque converter housing side axle seal (Figure 21).

- Use Seal Installer J-52282 and Driver Handle J-8092.
- Apply a light coat of CVT fluid to the seal lip surfaces.
- Proceed to step 3.

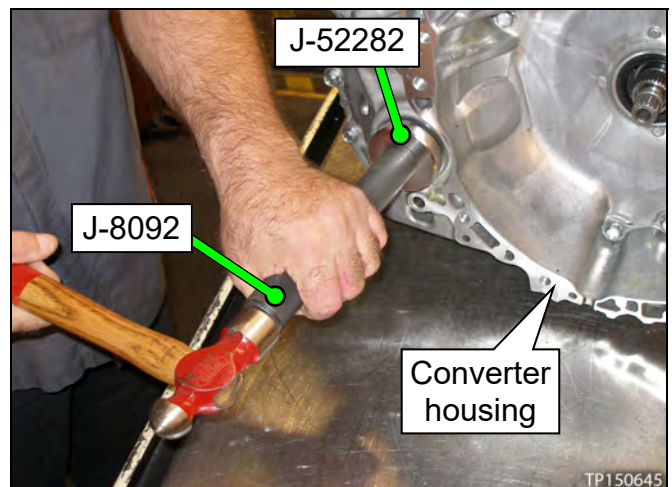

Figure 21

3. Apply petroleum jelly or equivalent to the dummy cover's lathe cut seals (Figure 31) before installing the dummy cover to the CVT case.

IMPORTANT:

- Confirm that the lathe cut seals (white seals) are in their appropriate slots. Carefully reposition seals as necessary.
- **Lathe cut seals must be in correct positions during final assembly to prevent drivability issues.**

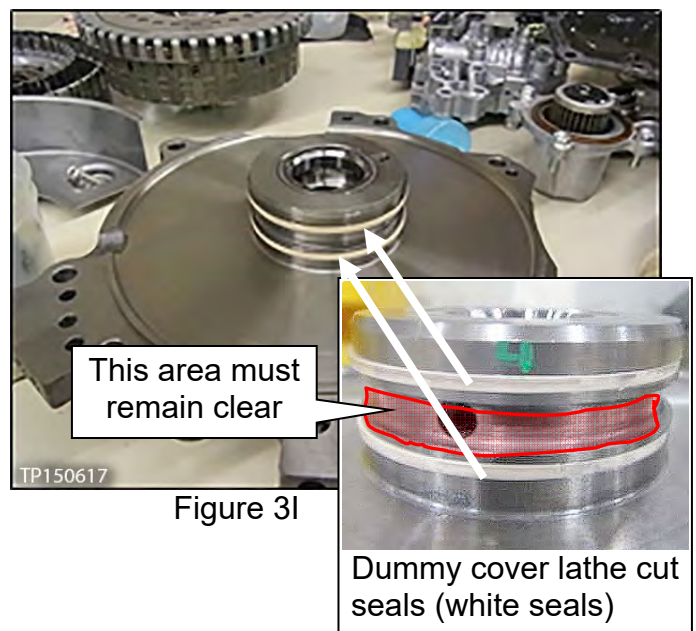

Figure 31

4. Confirm that the input shaft's lathe cut seals are in the correct locations.

IMPORTANT:

- Lathe cut seals (white seals) must be in their appropriate slots. Carefully reposition seals as necessary.
- **Lathe cut seals must be in correct positions during final assembly to prevent drivability issues.**

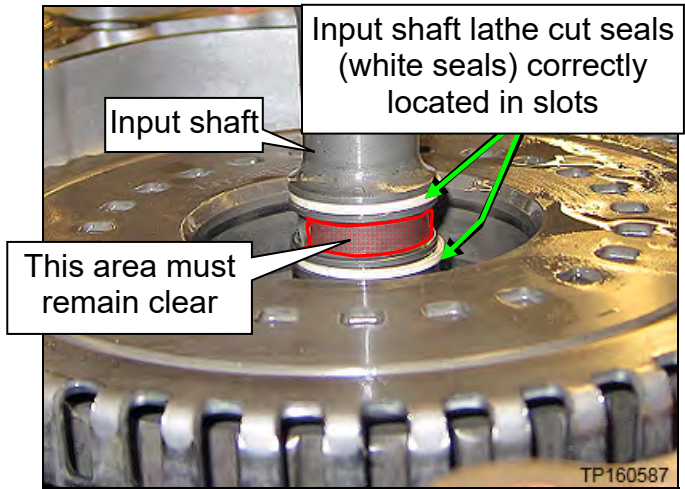

Figure 4I

5. Install the dummy cover first, then baffle plate C, and then the related bolts finger tight (Figure 5I).

IMPORTANT: Visually check that the dummy cover is fully seated on the CVT case. If it is not, refer to **Trouble Shooting** pages 90 – 91.

- Do not force the dummy cover into place.
- Make sure the dummy cover is fully seated before installing the bolts.
- Do not torque these bolts at this time.

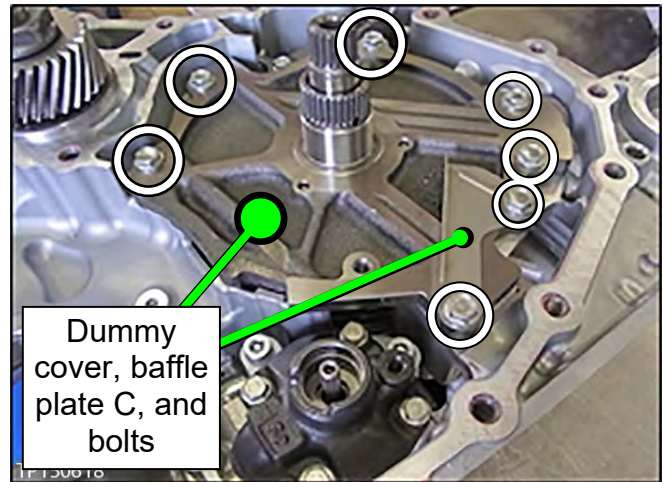

Figure 5I

6. Install baffle plate B and "L" bracket with the related bolts finger tight (Figure 6I).

7. Torque the bolts from step 5 and 6 in the following order:

- a. Baffle plate B bolts: 5.9 N•m (0.6 kg-m, **52.2 in-lb.**)
- b. "L" bracket bolts: 25.5 N-m (2.6 kg-m, 19 ft-lb). Torque **1** and then **2**.
- c. Dummy cover and baffle plate C bolts torque: 19.0 N•m (1.9 kg-m, **14 ft-lb.**)

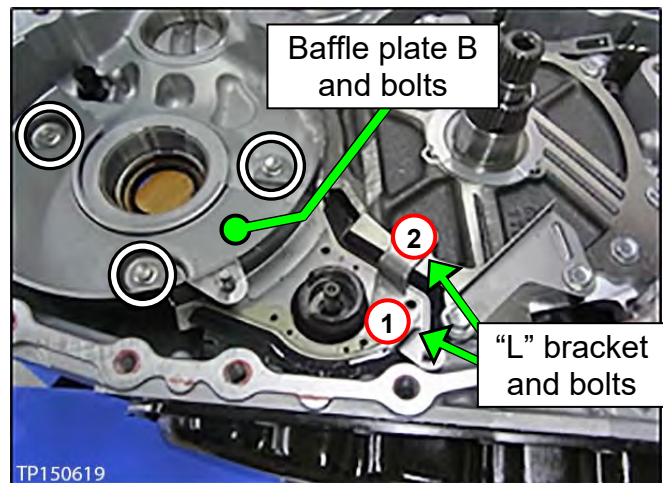

Figure 6I

8. Install the thrust washer onto the dummy cover (Figure 71).
 - Use petroleum jelly or equivalent to hold the thrust washer in place.
 - Make sure the tabs fit into the holes.

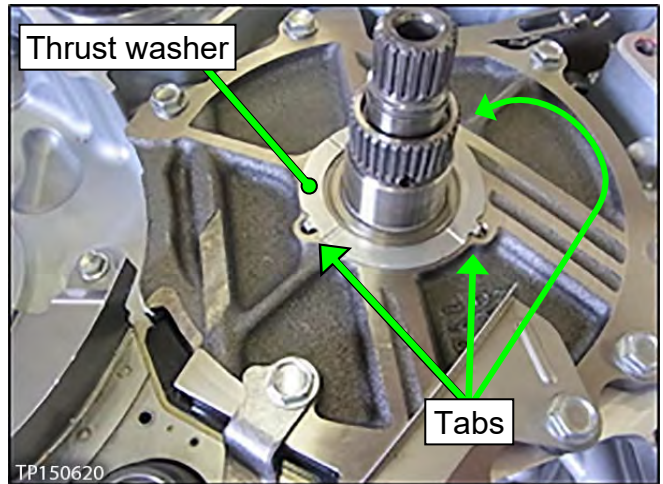

Figure 71

9. Install the drive sprocket, driven sprocket, and chain as an assembly (Figure 8I).
- Make sure the raised edge (wider edge) on the drive sprocket is facing up (Figure 9I).

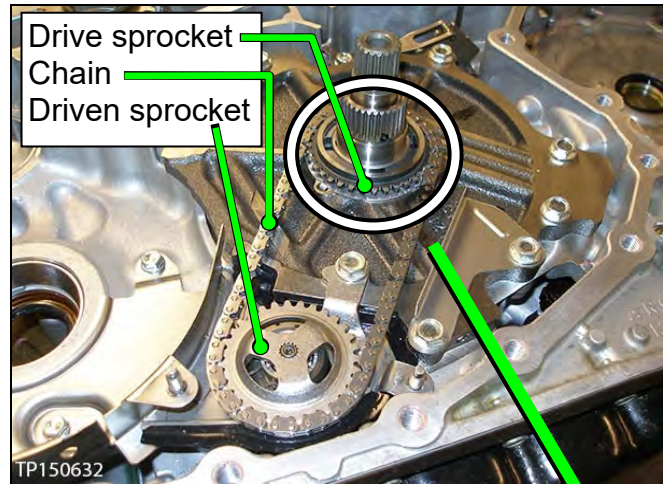

Figure 8I

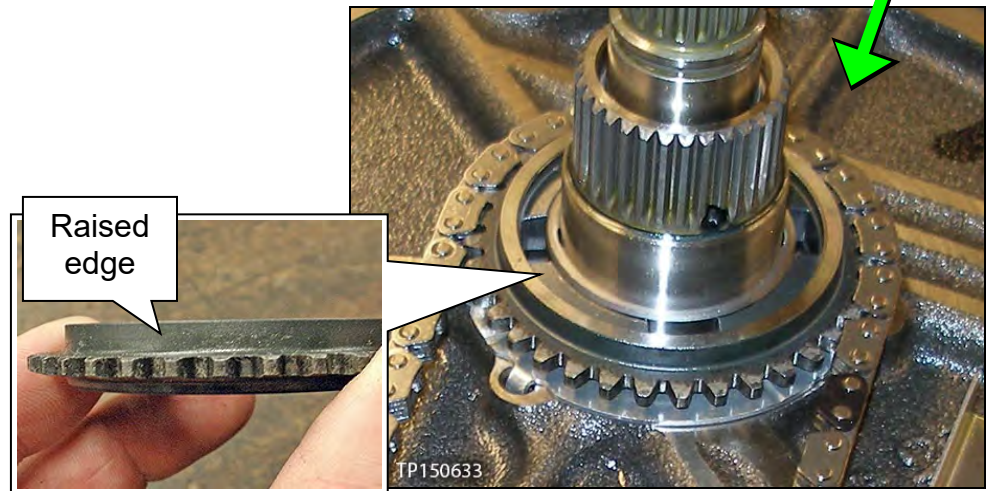

Figure 9I

- Expand the snap ring with a suitable tool, and then push down on the driven sprocket until it bottoms out (Figure 10I).
- Release the snap ring and then pull up on the driven sprocket until the snap ring locks into its groove.

NOTE: A click sound is heard when the snap ring locks in place.

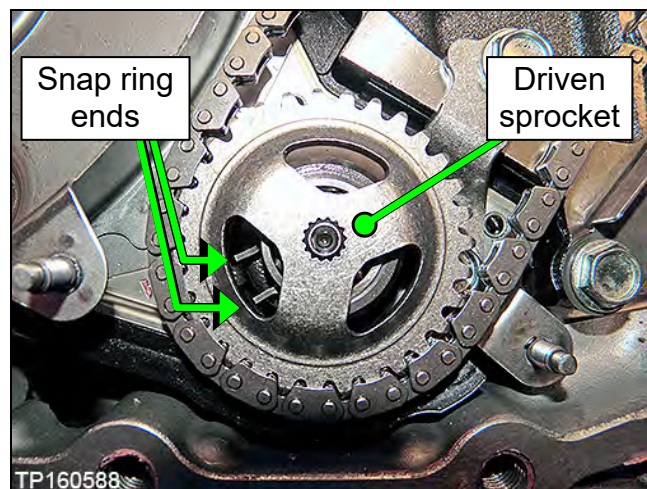

Figure 10I

10. Install baffle plate A with two nuts (Figure 11I).

- Nut torque: 5.9 N•m (0.6 kg-m, **52.2 in-lb.**)

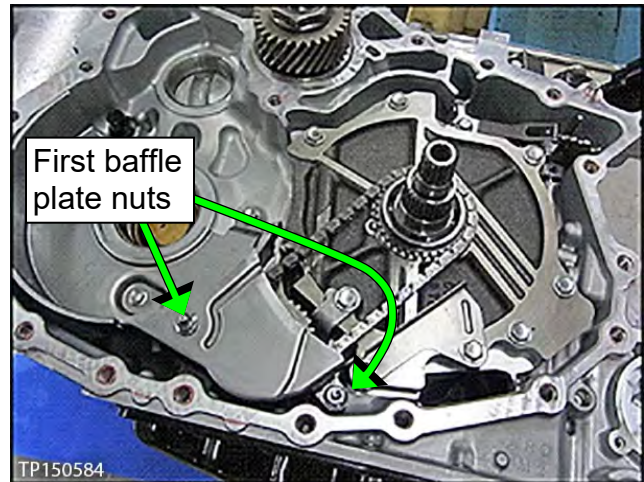

Figure 11I

11. Install a new O-ring on the input shaft (Figure 12I).

- Apply CVT fluid to the O-ring and O-ring groove before installing.

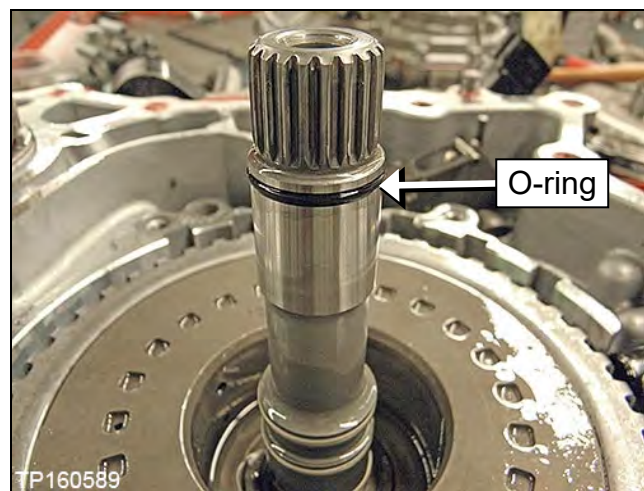

Figure 12I

12. Install the differential assembly and the reduction gear assembly into the CVT case (Figure 13I).

- Thoroughly clean each assembly before installing.
- Oil the bearings and gear teeth with CVT fluid before installing.

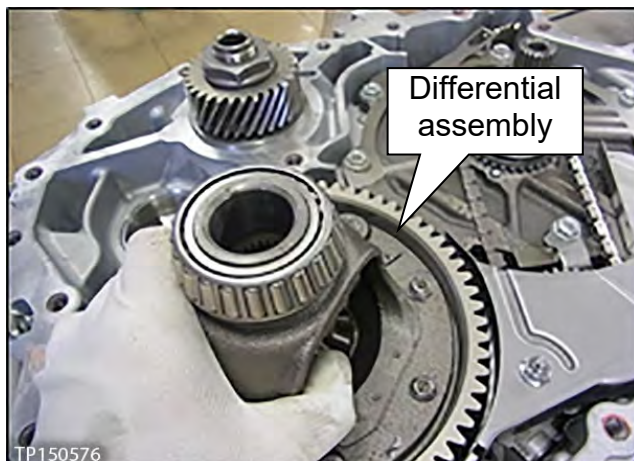

Figure 13I

13. Install the CVT fluid filter and components (Figure 14I).

- Install a new filter with grommet (one part).
- Install a new O-ring.
- Confirm that all components and areas where components fit are thoroughly clean.
- Apply CVT fluid to the grommet seal and O-ring before installing.
- Install the filter cover.
 - Bolt torque 4.2 N•m (0.43 kg-m, **37.2 in-lb.**)

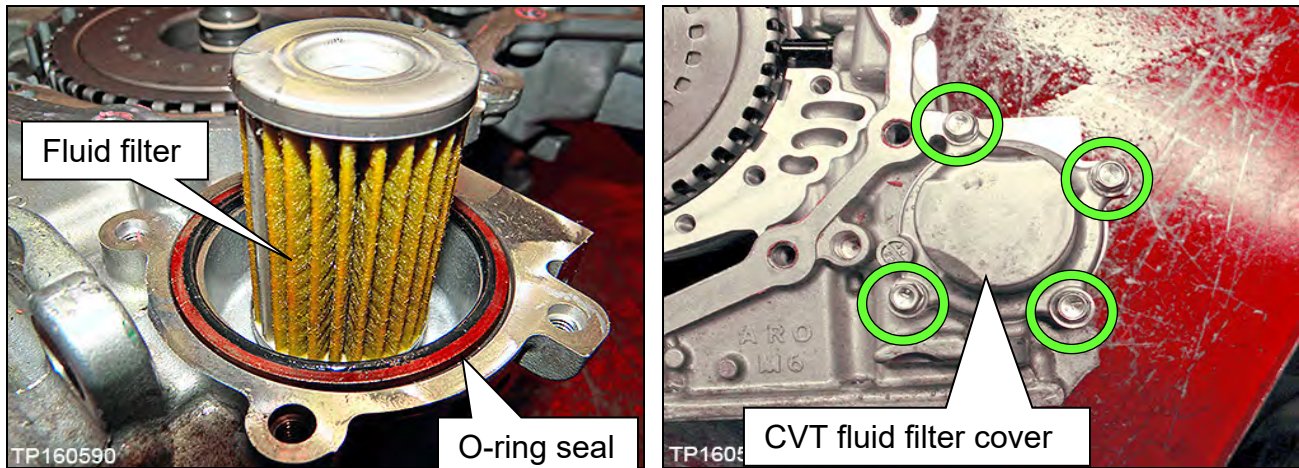

Figure 14I

14. Confirm the pin (Figure 15I) is located in the CVT case prior to installation of the converter housing.

NOTE: Apply petroleum jelly or equivalent to keep it in place if necessary.

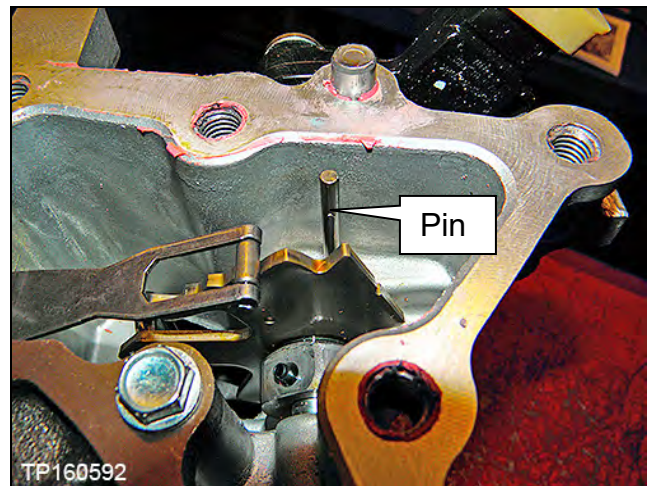

Figure 15I

15. Apply one continuous 2.0 mm (**0.8 inches**) diameter bead (Figure 16l) of pink colored Loctite 5460 Sealant (see the Parts Information section of this bulletin).

- Before sealant application, make sure the mating surfaces are clean from oil, dirt, old sealant, etc. (Figure 16l).

IMPORTANT: Have the converter housing ready for installation prior to applying the sealant.

NOTE:

- Start applying sealant where shown, making sure that the starting point and the ending point are about the middle between the bolt holes.
- Overlap both ends of the bead by 3-5 mm (**0.12-0.20 inches**).
- Make sure to apply sealant around the center bolt hole.

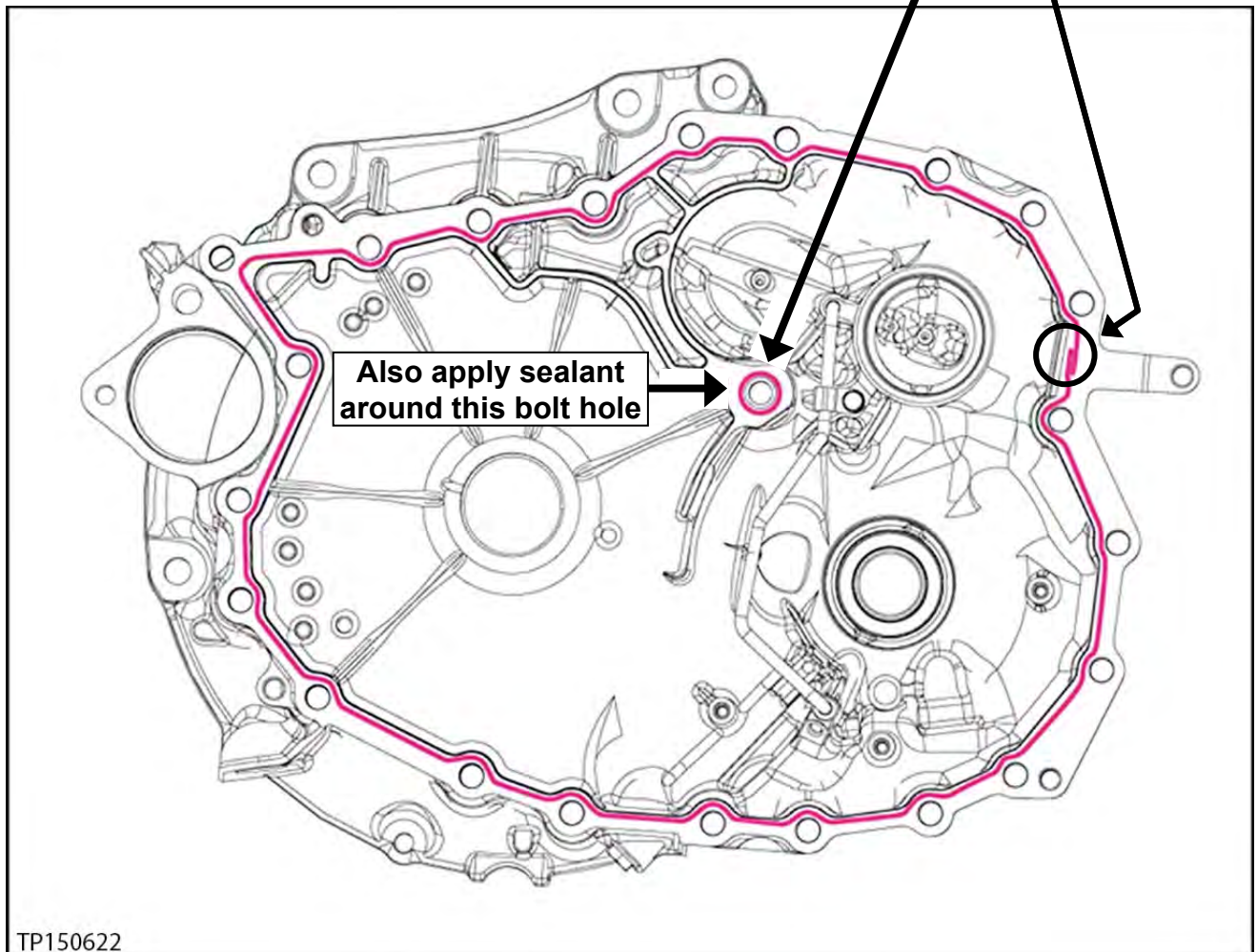



Figure 16l

16. Install the converter housing onto the CVT case (see Figure 171 for torque sequence):

- Install new bolts (23).
 - a. Torque the first six (6) bolts with symbol  in numbered sequence (see below).
 - b. Torque the remaining bolts with symbol  in numbered sequence (see below).

➤ Use a short socket on the bolts indicated by this symbol: 

➤ All bolts are 30 mm (1.2 inches) in length.

➤ Bolts torque: 45.0 N•m (4.6 kg-m, 33.2 ft-lb.)

IMPORTANT: Make sure to torque the bolts in the sequence shown (Figure 171).

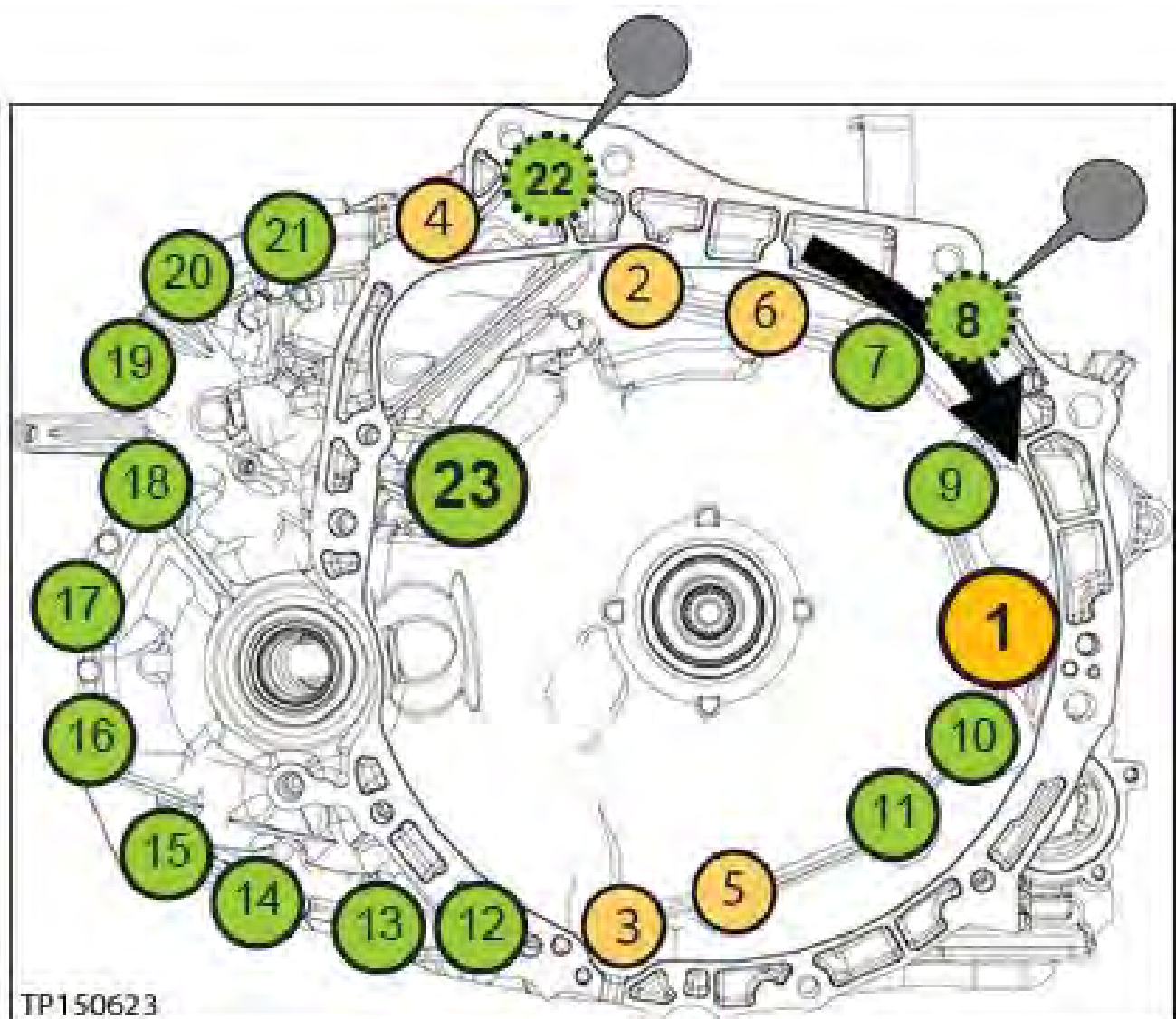

Figure 171

17. Clean off the excess sealant.

Control Valve (Valve Body) Strainer and Pan Installation

IMPORTANT:

- Installation steps in this bulletin may contain different style parts than what were originally installed in the CVT. Pay careful attention, REASSEMBLY MAY NOT BE IDENTICAL TO DISASSEMBLY.
- **Confirm that the QR label, control valve and CD part numbers all match before installing the control valve** (refer to NTB12-103).
- For additional information, see video # 547: “CVT Belt and Pulley Replacement” and fast forward to minute marker 20:09. This video is located under the TECH TRAINING GARAGE VIDEOS tab in Virtual Academy.

CAUTION: Handle the valve body carefully.

NOTE: If an oil strainer bracket was removed, discard it. An oil strainer bracket (Figure 1J) will not be used with the new oil strainer.

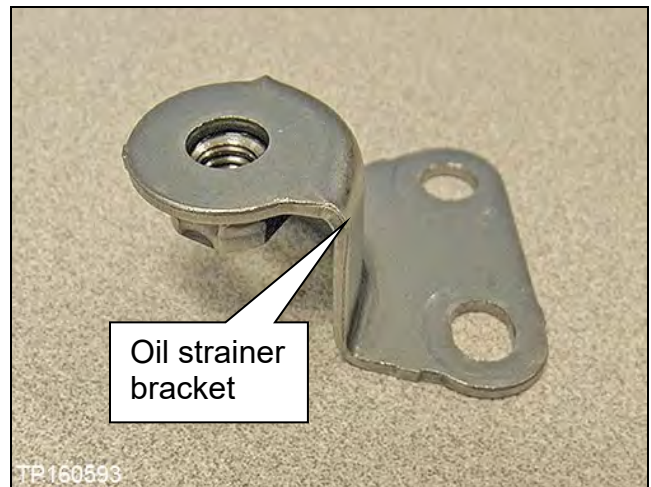

Figure 1J

1. Install a new lip seal (Figure 2J).

- Do NOT reuse the old lip seal.
- Apply a small amount of petroleum jelly or equivalent to the lip seal to keep it in place on the CVT.

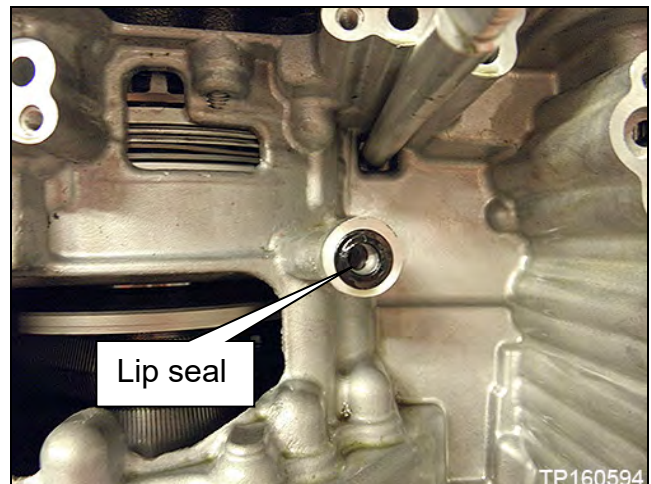

Figure 2J

2. Install the Control Valve with eleven (11) mounting bolts (Figure 3J).

IMPORTANT: Leave four (4) ✘ bolt holes blank at this step.

CAUTION: Make sure the wiring harness does not get pinched (see Figures 4J and 5J for correct routing).

- 54 mm (2.125 inches) long bolt ●; 7 pieces
- 44 mm (1.73 inch) long bolt ●; 2 pieces
- 25 mm long (1 inch) long bolt ●; 2 pieces

CAUTION: The two 25 mm bolts are installed WITHOUT the strainer bracket.

- Bolt torque: 7.9 N•m (0.81 kg-m, 70 in-lb.)

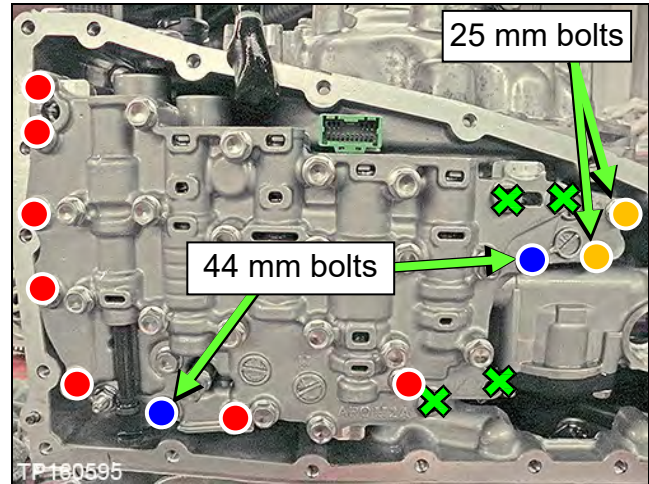

Figure 3J

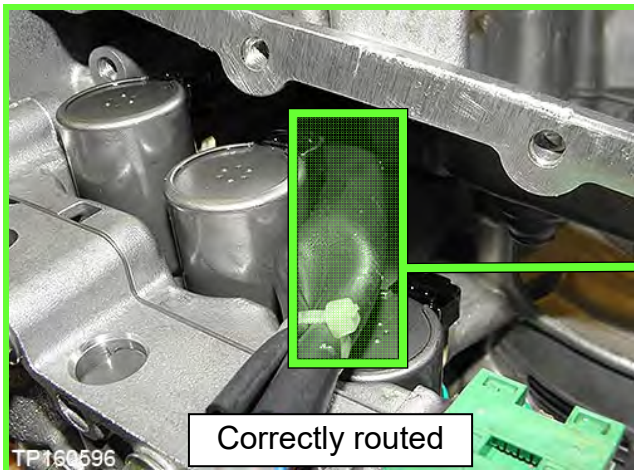

Figure 4J

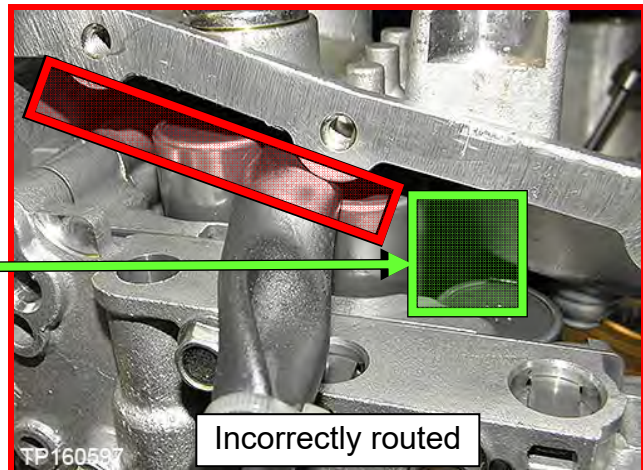

Figure 5J

3. Replace the metal bracket of the fluid temperature sensor as follows:

NOTE: The new bracket will be oriented the same way the old bracket was.

- a. Cut the old plastic zip tie with an appropriate tool to remove the fluid temperature sensor's metal bracket from the terminal harness assembly (Figure 6J and Figure 7J).

CAUTION: Cut the plastic zip tie over the metal bracket to avoid damage to the fluid temperature sensor.

- b. Discard the removed metal bracket and plastic zip tie.
- c. Use the new plastic zip tie from the Parts Information to attach the fluid temperature sensor of the terminal connector harness to the fluid temperature sensor's new metal bracket.

IMPORTANT:

- Locate the plastic zip tie at the center notch of three notches on the fluid temperature sensor (Figure 7J).
 - Tighten the plastic zip tie so that it is oriented as shown in Figure 6J.
- d. Cut off the plastic zip tie excess.

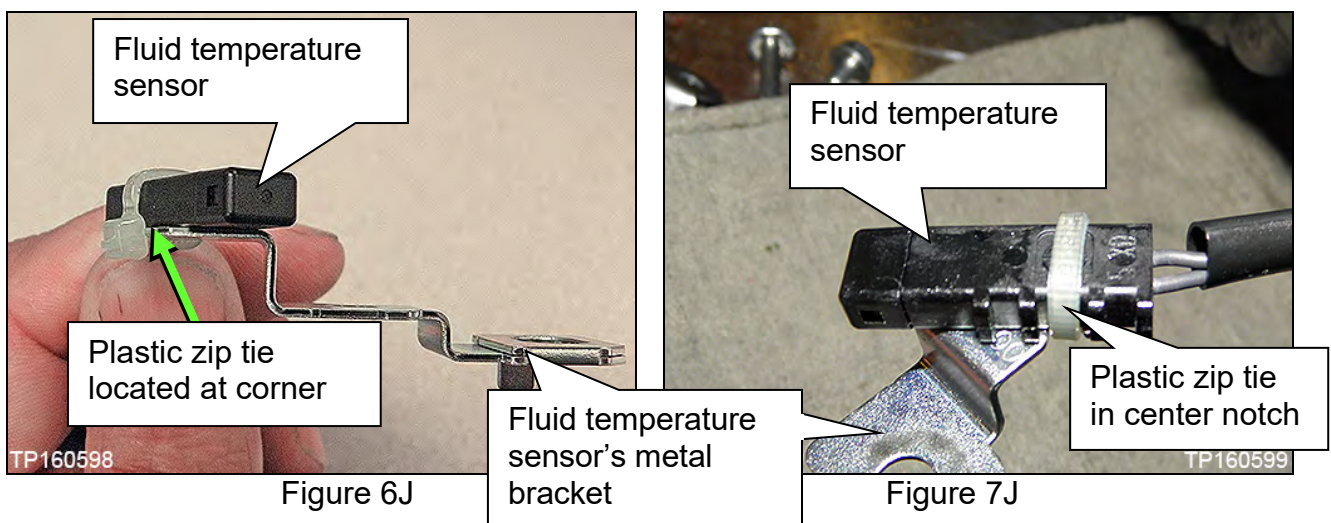

4. Connect the electrical harness connector (Figure 8J).

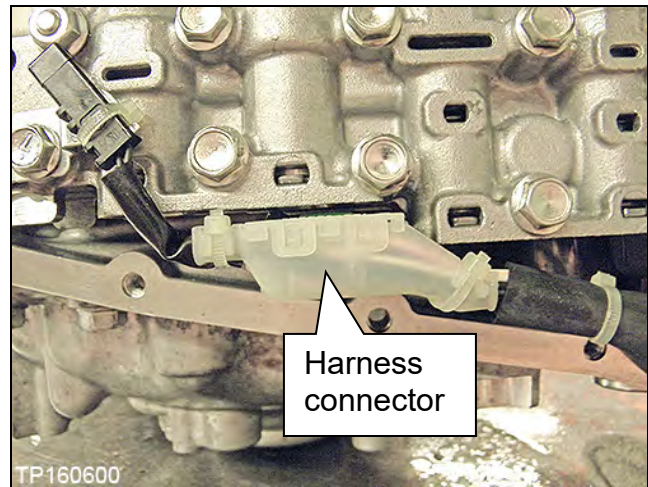

Figure 8J

5. Install the CVT fluid temperature sensor bracket to the valve body with one (1) bolt (Figure 9J).

NOTE: Leave one (1) bolt hole blank as it will be used to secure the oil strainer at a later step.

- 54 mm (2.125 inches) long bolt.
 - Bolt torque: 7.9 N•m (0.81 kg-m, 70 in-lb.)

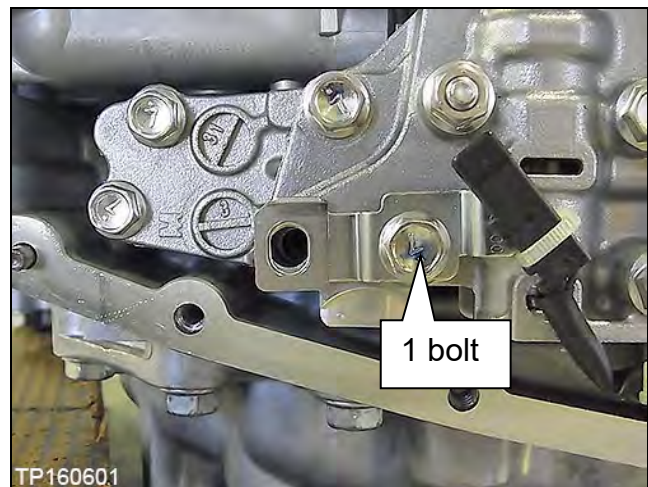



Figure 9J

6. Install the new oil strainer with its new O-ring seal with two (2) bolts (Figure 10J).

NOTE: Replacement strainer maybe a different shape than the original.

- 54 mm (2.125 inches) long bolt ; 2 pieces.
 - Bolt torque: 7.9 N•m (0.81 kg-m, 70 in-lb.)

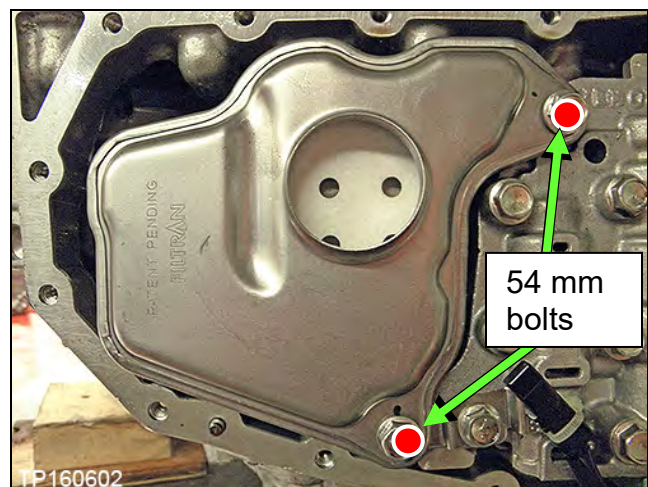

Figure 10J

7. Install the manual plate, lock washer, and nut (Figure 11J).

NOTE: Make sure the manual plate fits into the slot of the manual valve before applying torque to the nut.

- Reuse the existing manual plate, lock washer, and nut.
 - Nut torque: 22.1 N•m (2.3 kg-m, **16 ft-lb.**)

8. Clean the original oil pan and magnets with a suitable cleaner. Visible debris should not be present at re-assembly.

9. Reassemble the original magnets to the pan.

NOTE: Return the magnets to their original locations.

10. Install a new oil pan gasket to the pan.

11. Install the oil pan bolts (see Figure 12J).

- Reuse the existing pan bolts.
 - Oil pan bolts torque: 7.9 N•m (0.81 kg-m, **70 in-lb.**)

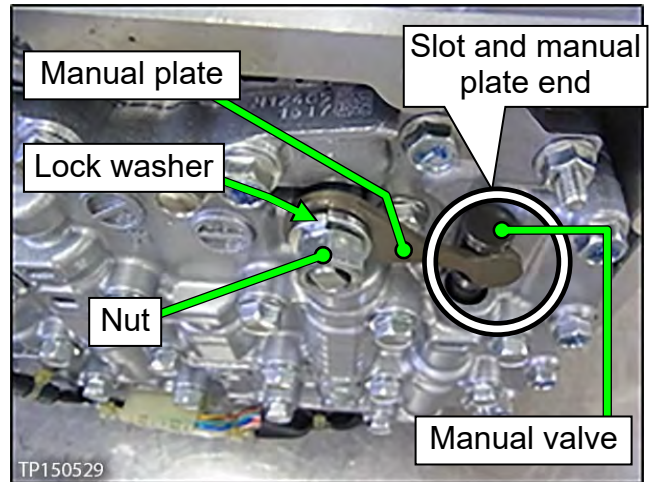

Figure 11J

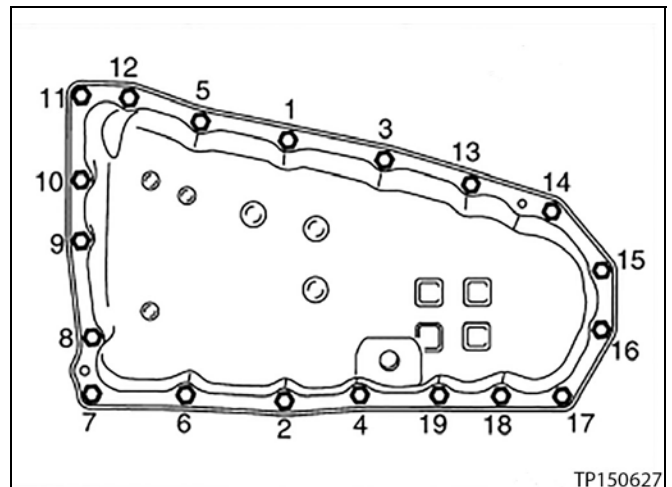

Figure 12J

12. Install a new drain washer to the drain plug on the oil pan.

13. Install the primary speed sensor to the CVT assembly. (Perform only if installing CVT assembly.)

IMPORTANT: Install a new O-ring to the speed sensor before installation. DO NOT reuse the old O-ring.

- Bolt torque: 5.9 N•m (0.6 kg-m, **52 in-lb.**)

14. Install the torque converter to the CVT assembly. (Perform only if installing CVT assembly.)
- Verify the torque converter is installed at the proper depth (see Figure 13J).
 - $\textcircled{A} = 14.4 \text{ mm}$

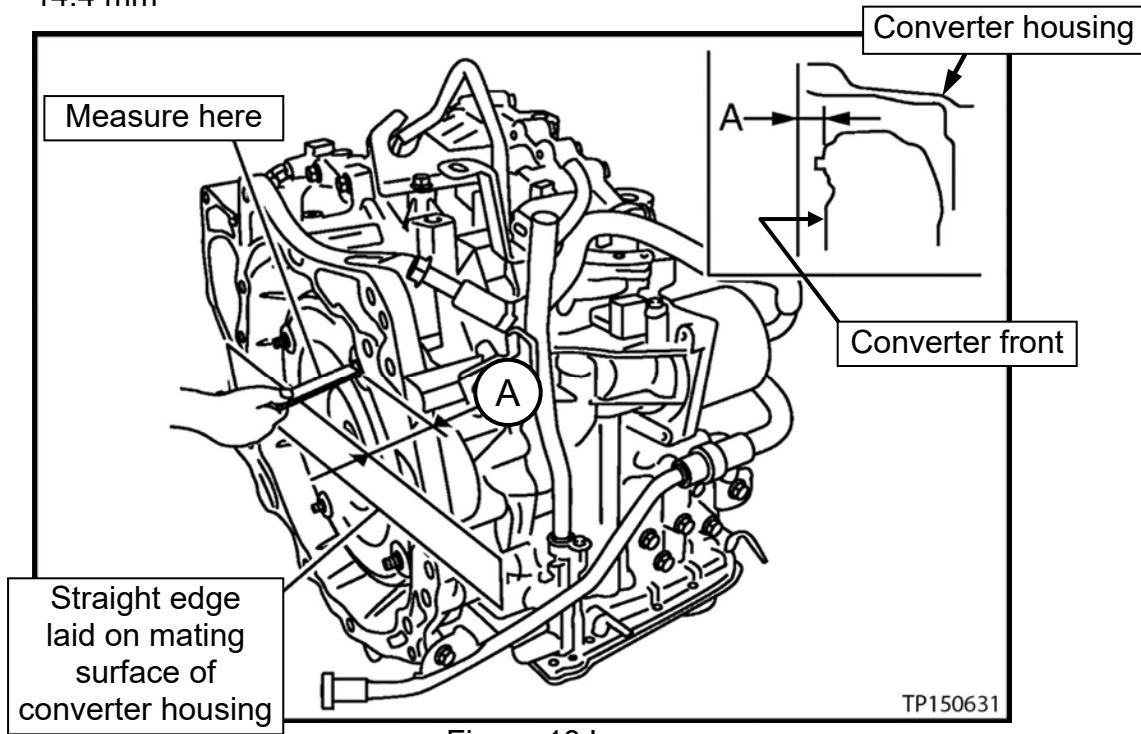

Figure 13J

15. Attach the QR label (Figure 14J) with the new calibration data onto the transmission range switch (inhibitor switch Figure 15J).
- A QR Label and CD-R are included with the new valve body.
 - Confirm that the QR label and the CD-R part numbers are the same (Figure 14J).

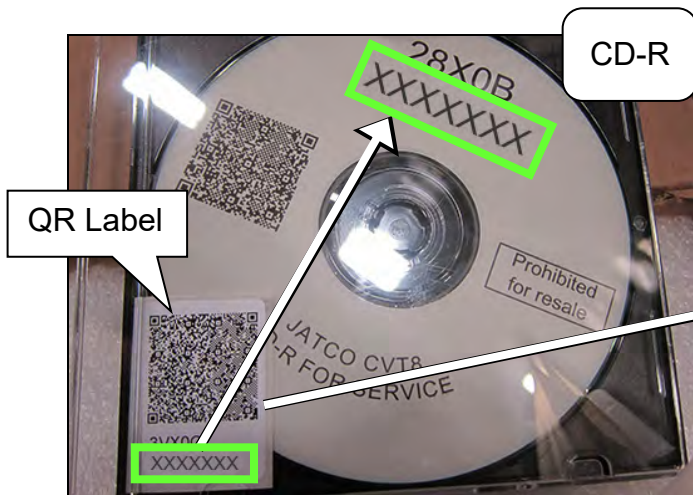

Figure 14J

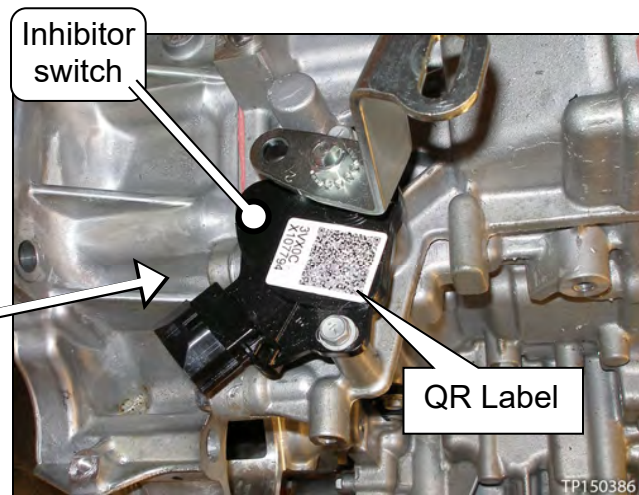

Figure 15J

Install the CVT Assembly

1. Install the CVT assembly into the vehicle.

NOTE: Refer to the ESM, section **TM – Transaxle & Transmission**, for CVT installation.

And then,

- 2WD vehicles skip to step 2 below.
- Vehicles with all-wheel drive, install the transfer case as follows:
 - a. Replace only the external O-ring to the transfer case and then install the transfer case to the CVT.
 - Apply CVT fluid to the O-ring.

NOTE:

- Refer to the ESM, section **DLN – Driveline**, for the transfer assembly installation.
 - Use extreme caution when installing the axle to the transfer assembly to avoid seal damage or deformation.
 - Properly support and guide the axle.
- b. Proceed to step 2.

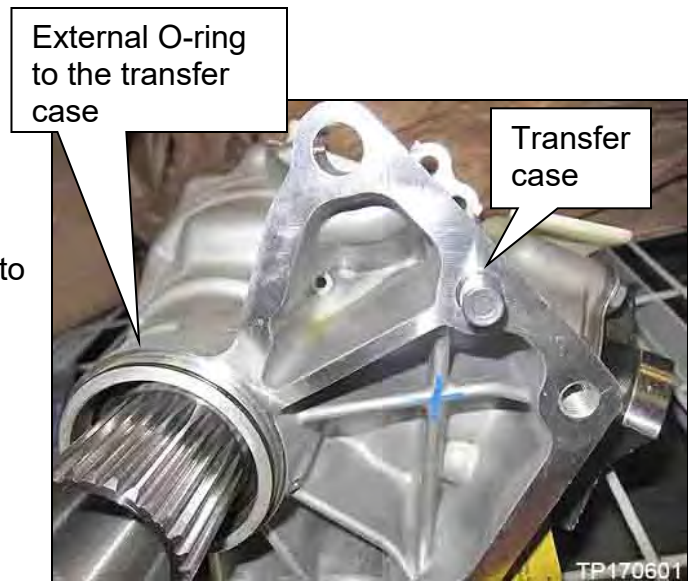

Figure 16J

2. Flush the CVT cooler.

IMPORTANT: A CVT Cooler flush is required. Refer to bulletin NTB15-013 to perform CVT Cooler flush.

3. Connect both battery cables, negative cable last.
4. Reset/reinitialize systems as needed.
 - Refer to the ESM, section **PG – Power Supply & Ground Elements**, for a listing of systems that require reset/initialization after reconnecting the 12V battery.
 - Look in the PG section index for **ADDITIONAL SERVICE WHEN REMOVING BATTERY NEGATIVE TERMINAL**.
 - This list often includes items such as radio, power windows, clock, sunroof, etc.
5. Refer to step 6 on page 80 and confirm if a TCM reprogram is available for the vehicle you are working on.

Is a reprogram available?

- **YES:** Perform **TCM reprogramming** starting on page 78.
- **NO:** Proceed to step 16 on page 85.

TCM Reprogramming

IMPORTANT: Before starting, make sure:

- ASIST on the CONSULT PC has been synchronized (updated) to the current date.
- All CONSULT-III plus (C-III plus) software updates (if any) have been installed.

NOTE:

- Most instructions for reprogramming with C-III plus are displayed on the CONSULT PC screen.
- If you are not familiar with the reprogramming procedure, [click here](#). This will link you to the "CONSULT- III plus (C-III plus) Reprogramming" general procedure.

CAUTION:

- Connect the GR8 to the vehicle battery, set to "power supply" mode. If the vehicle battery voltage drops below 12.0V or rises above 15.5V during reprogramming, the TCM may be damaged.
- Be sure to turn OFF all vehicle electrical loads. If a vehicle electrical load remains ON, the TCM may be damaged.
- Be sure to connect the AC Adapter. If the CONSULT PC battery voltage drops during reprogramming, the process will be interrupted and the TCM may be damaged.
- Turn OFF all external Bluetooth® devices (e.g., cell phones, printers, etc.) within range of the CONSULT PC and the VI. If Bluetooth® signal waves are within range of the CONSULT PC during reprogramming, reprogramming may be interrupted and the TCM may be damaged.

1. Connect the CONSULT PC to the vehicle to begin the reprogramming procedure.
2. Start C-III plus.
3. Wait for the plus VI to be recognized.
 - The serial number will display when the plus VI is recognized.
4. Select **Re/programming, Configuration**.

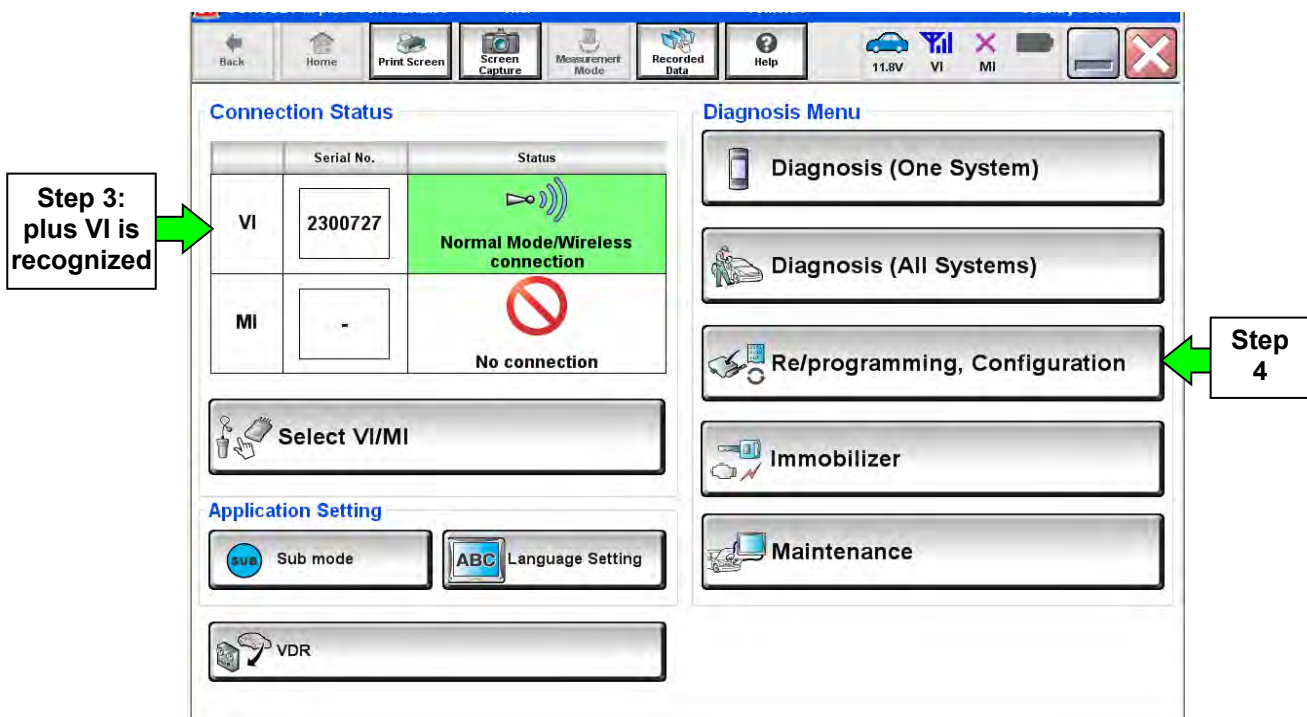

Figure 1K

5. Follow the on-screen instructions and navigate the C-III plus to the screen shown in Figure 2K on the next page.
6. When you get to the screen shown in Figure 2K, confirm reprogramming applies as follows.
 - A. Find the TCM **Part Number** and write it on the repair order.

NOTE: This is the current TCM Part Number (P/N).

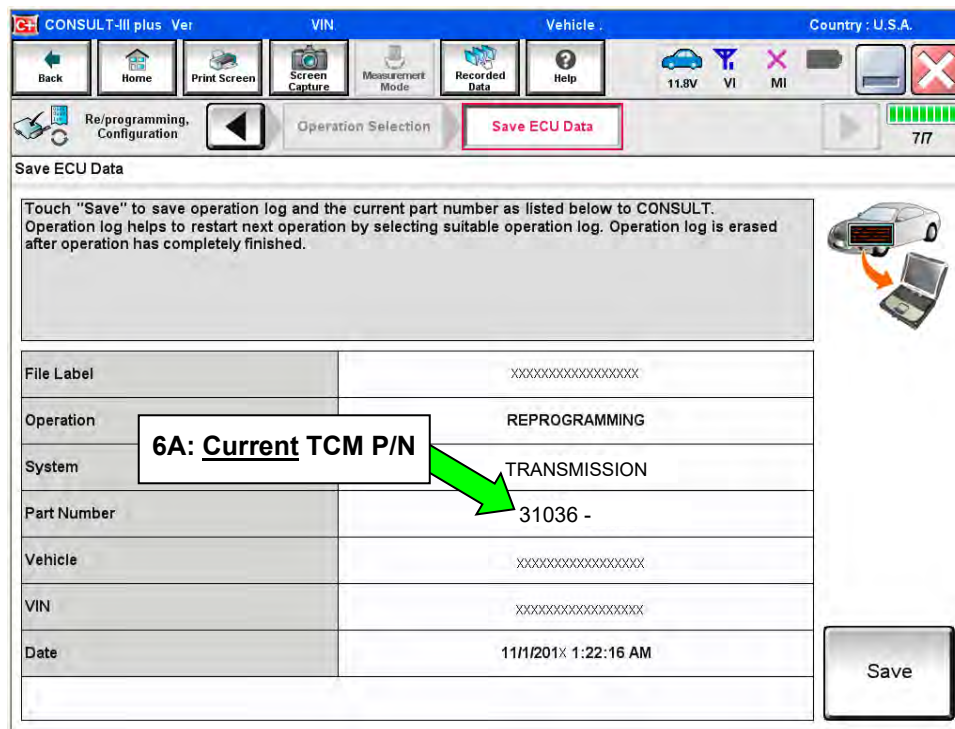

Figure 2K

B. Compare the P/N you wrote down to the numbers in the **Current TCM Part Number** column in **Table B** below.

- If there is a match, continue with the reprogramming procedure.
- If there is not a match, reprogramming is not needed.

Table B

MODEL	MODEL YEAR	CURRENT TCM PART NUMBER BEFORE REPROGRAMMING: 31036 -
Altima (4-cyl engine only)	2013	3TA0A 3TA4A, 3TA4B, 3TA4C 3TA9C 3TY0A, 3TY0B, 3TY0C, 3TY0D, 3TY0E 3TY1A, 3TY1B, 3TY1C, 3TY1D, 3TY1E
	2014-2015	9HM0A, 9HM0C, 9HM0D, 9HM0E 9HM3A, 9HM3B, 9HM3C
	2016	3TE0C, 3TE0D, 3TE2C, 3TE2D 3TH0A, 3TH0B, 3TH2A, 3TH2B
	2017	9HS4A, 9HS6A
Rogue	2014	4BA0A, 4BA0B, 4BA5A, 4BA5B 4BA8A 4BA9A, 4BA9B, 4BA9C, 4BA9D
	2015	5HA0A, 5HA0B, 5HA0C 5HA5A, 5HA9A 9TA0A, 9TA0B, 9TA0C, 9TA0D 9TA5A, 9TA9A
	2016	5HJ0A, 5HJ0B, 5HJ0C, 5HJ0D 5HJ9A, 6FJ0A, 6FJ0B, 6FJ0C, 6FJ0D, 6FJ9A, 6FK0A

7. Follow the on-screen instructions to navigate C-III plus and reprogram the ECM.

NOTE:

- In some cases, more than one new P/N for reprogramming is available.
 - If more than one new P/N is available, the screen in Figure 3K displays.
 - Select and use the reprogramming option that does **not** have the message “Caution! Use ONLY with NTBXX-XXX”.
- If you get this screen and it is blank (no reprogramming listed), it means there is no reprogramming available for this vehicle. Close C-III plus and refer back to ASIST for further diagnosis.

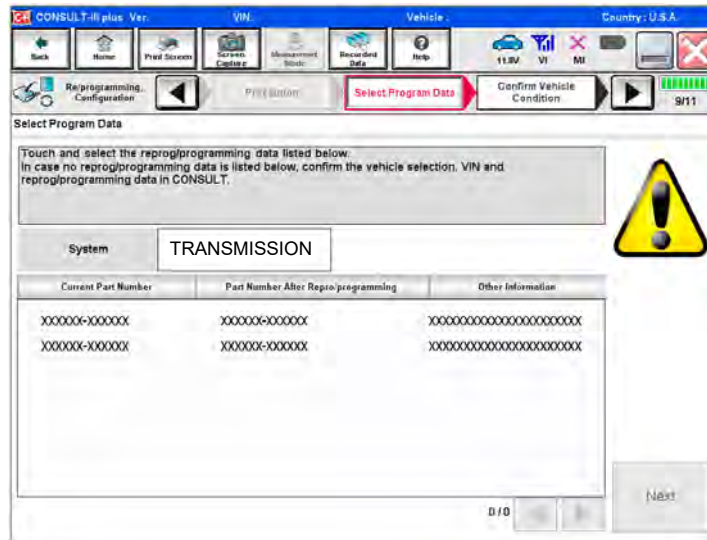

Figure 3K

- Before reprogramming will start, you will be required to enter your User Name and Password.
 - The CONSULT PC must be connected to the Internet (Wi-Fi or cable).
 - If you do not know your User Name and Password, contact your Service Manager.

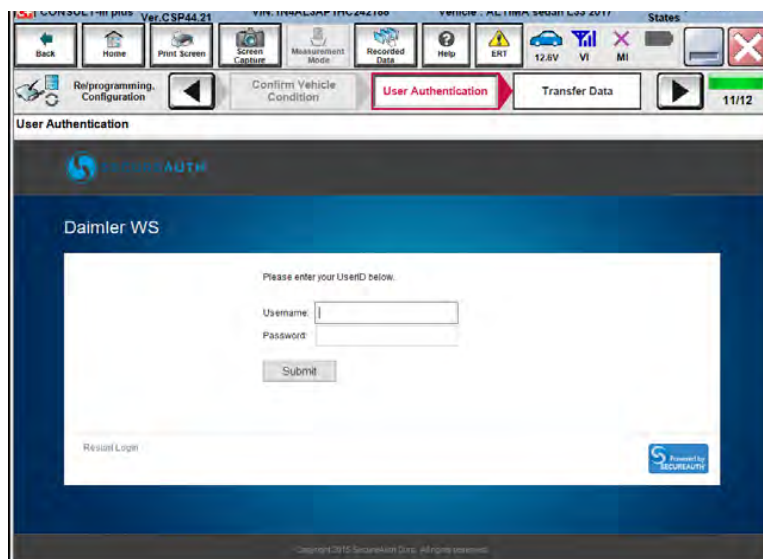

Figure 4K

8. When the screen in Figure 5K displays, reprogramming is complete.

NOTE: If the screen in Figure 5K does not display (indicating that reprogramming did not complete), refer to the information on the next page.

9. Disconnect the battery charger from the vehicle.

10. Select **Next**.

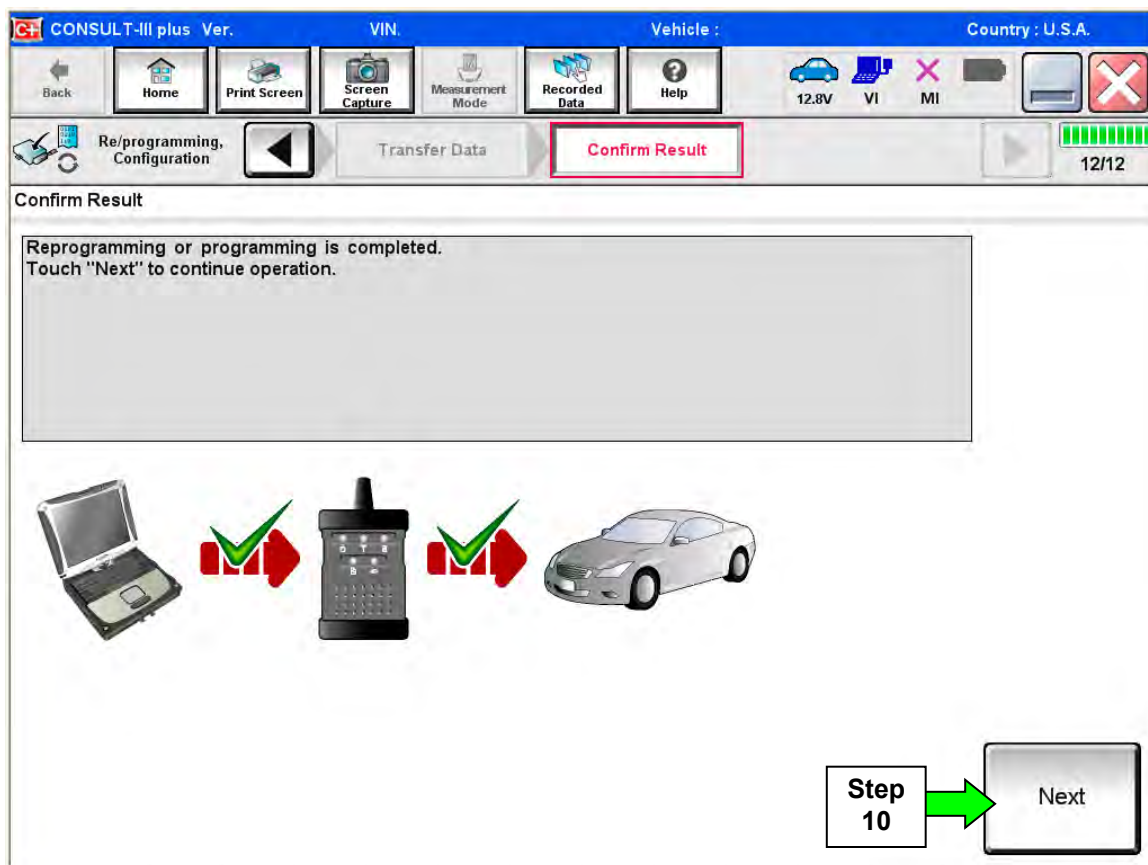

Figure 5K

NOTE:

- In the next step (page 84) you will perform **Erase All DTCs**.
- DTC erase is required before C-III plus will provide the final reprogramming confirmation report.

TCM Recovery:

Do not disconnect plus VI or shut down C-III plus if reprogramming does not complete.

If reprogramming does not complete and the “!?” icon displays as shown in Figure 6K:

- Check battery voltage (12.0–15.5 V).
- Ignition is ON, engine OFF.
- External Bluetooth® devices are OFF.
- All electrical loads are OFF.
- **Select retry and follow the on screen instructions.**
- **“Retry” may not go through on first attempt and can be selected more than once.**

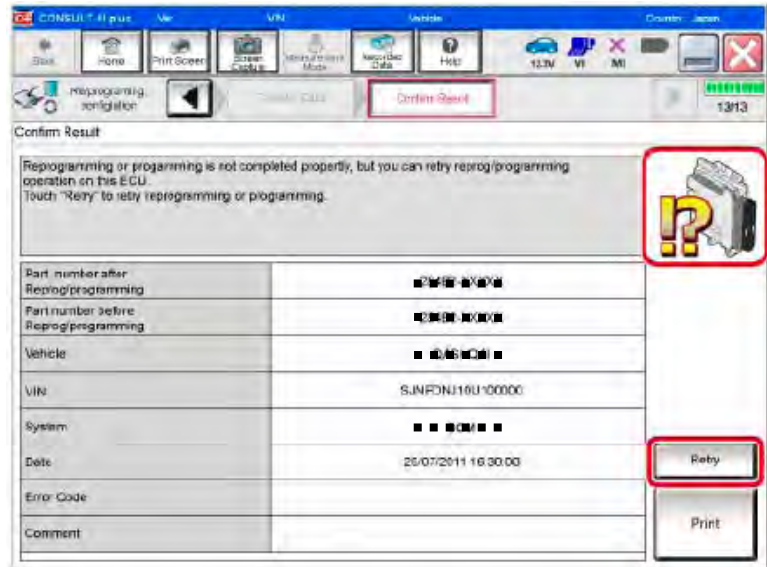

Figure 6K

If reprogramming does not complete and the “X” icon displays as shown in Figure 7K:

- Check battery voltage (12.0 – 15.5 V).
- CONSULT A/C adapter is plugged in.
- Ignition is ON, engine OFF.
- Transmission is in Park.
- All C-III plus / VI cables are securely connected.
- All C-III plus updates are installed.
- **Select Home, and restart the reprogram procedure from the beginning.**

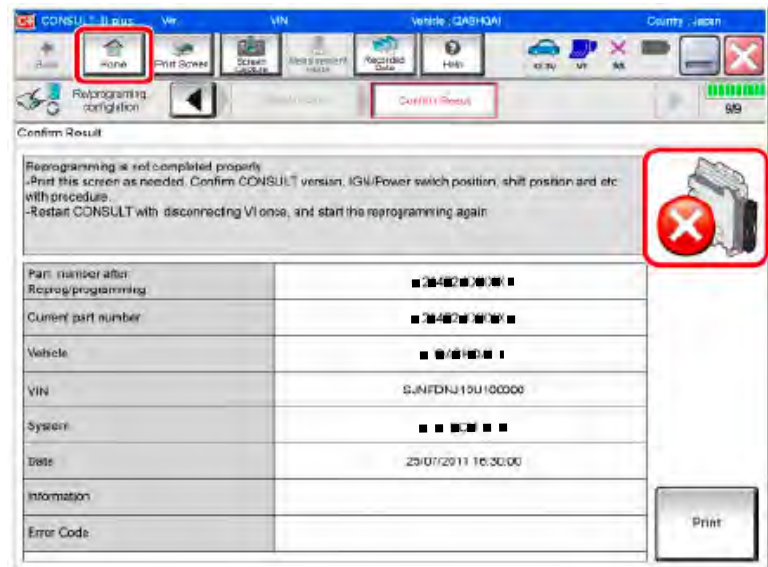

Figure 7K

11. Follow the on-screen instructions to **Erase All DTCs**.
12. When the entire reprogramming process is complete, the screen in Figure 8K will display.
13. Verify the before and after part numbers are different.
14. Print a copy of this screen (Figure 8K) and attach it to the repair order for warranty documentation.
15. Select **Confirm**.

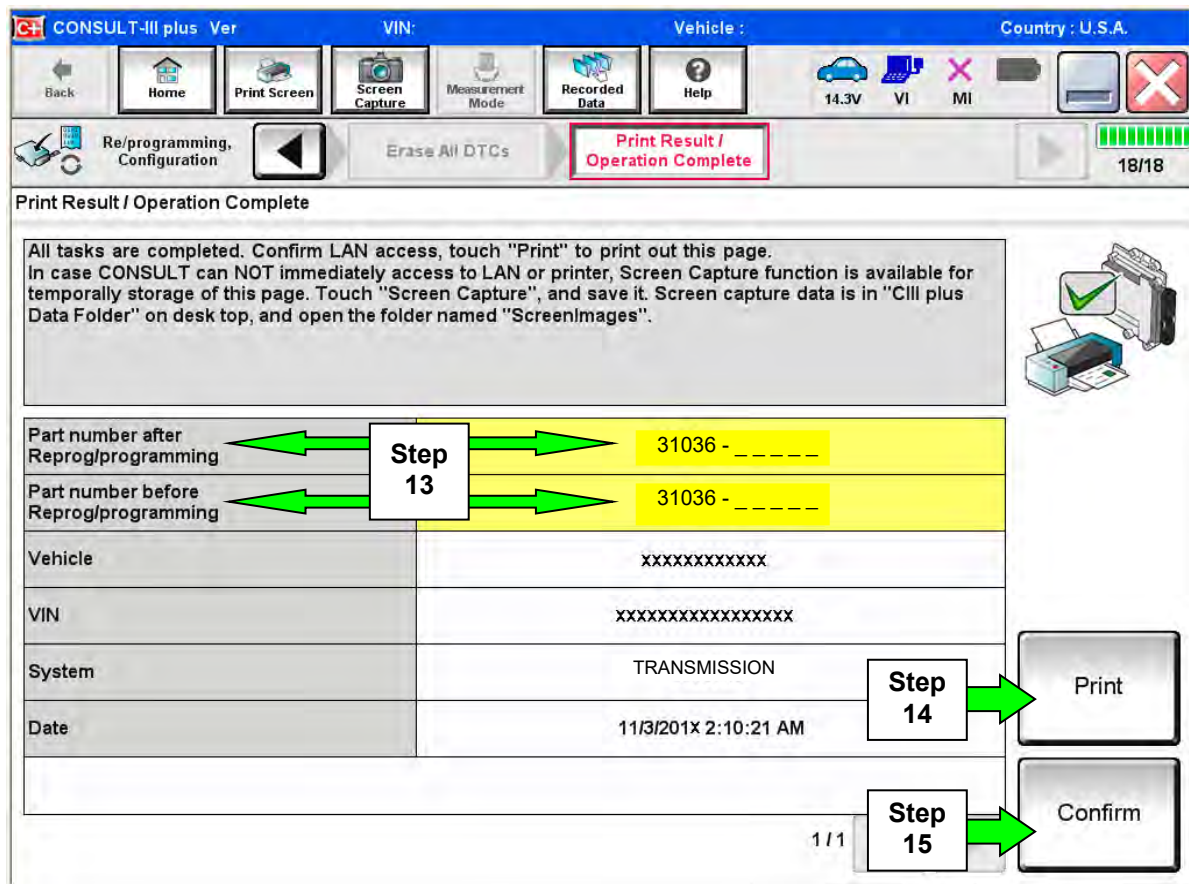

Figure 8K

16. Perform **ADDITIONAL SERVICE WHEN REPLACING CONTROL VALVE.**

- Refer to **TM – Transaxle & Transmission / RE0F10E / BASIC INSPECTION**, and perform **ADDITIONAL SERVICE WHEN REPLACING CONTROL VALVE.**
 - **NOTE:** Use the procedure starting on page 86 for **FWD CLUTCH POINT LEARNING.**
- Use the check-off table below and check off each Additional Service Procedure as they are performed.

IMPORTANT: Check off these additional services as they are completed and attach this to the repair order when finished.

CHECK OFF	ADDITIONAL SERVICE PROCEDURE
	PRINT CURRENT CALIBRATION DATA
	CHECK THE SERIAL NUMBER
	WRITE THE DATA (WRITE IP CHARA)
	PRINT NEW CALIBRATION DATA
	FWD CLUTCH POINT LEARNING (If needed, TCM reprogramming must be done first. Use procedure starting on page 86.)
	PERFORM SELECT LEARNING (DRIVE/REVERSE LEARNING on page 89)
	ERASE CVT FLUID DEGRADATION LEVEL DATA

17. Return C-III plus to the Home screen.

18. Turn OFF C-III plus and the vehicle ignition.

19. Disconnect C-III plus from the vehicle.

20. Test drive the vehicle:

- Make sure the MIL is OFF.
 - This bulletin does not cover any DTC repairs other than those listed on page 2 in the Repair Flow Chart.
 - If the MIL comes ON, go to ASIST for further diagnostic information.
- Verify the CVT operates normally and no abnormal noises are heard during a test drive.

FWD CLUTCH POINT LEARNING (using CONSULT-III plus)

NOTE: If a TCM update is available (see page 80), the TCM MUST be reprogrammed before performing FWD CLUTCH POINT LEARNING.

1. Apply the vehicle's parking brake.
2. Start the engine and warm up to operating temperature (50-100° C [122-212° F]).
3. Connect the CONSULT PC to the vehicle.
4. Start C-III plus.
5. Wait for the plus VI to be recognized.
 - The serial number will display when the plus VI is recognized.
6. Select **Diagnosis (One System)**.

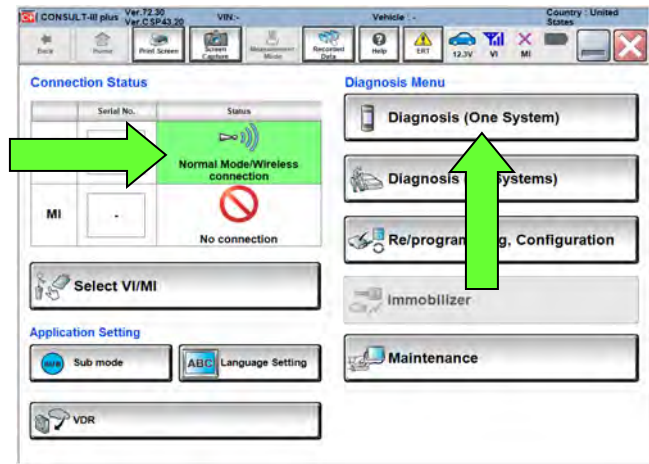

Figure 1L

7. Select **Work Support** under TRANSMISSION.

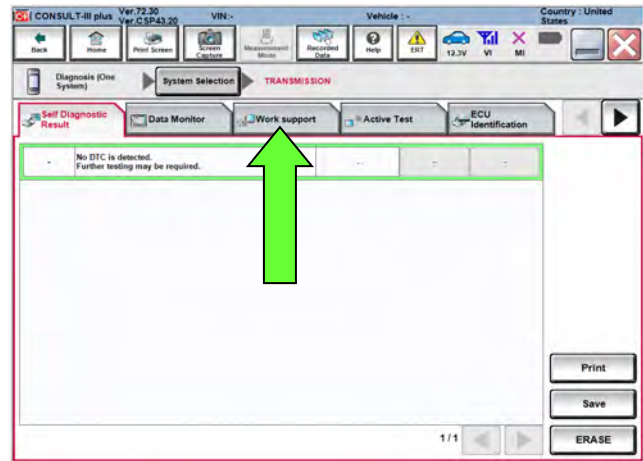

Figure 2L

IMPORTANT: The following **FWD CLUTCH POINT LEARNING** will be performed twice; once in drive (D) and once in reverse (R).

8. Select **FWD CLUTCH POINT LEARNING** and then **Start**.

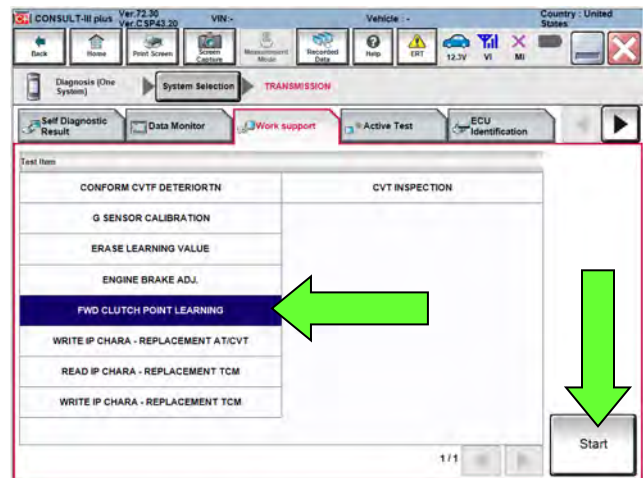

Figure 3L

9. With the engine still running and at idle, depress the brake pedal and shift the CVT into neutral (N).

- Confirm that all of the required conditions indicated in Figure 4L are being met.

10. Select **Start**.

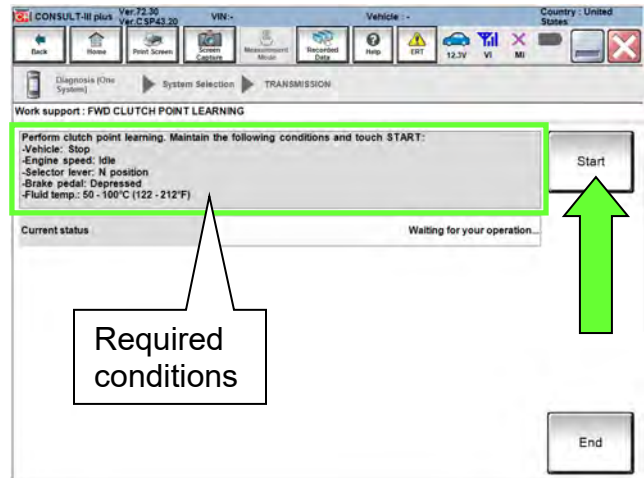

Figure 4L

11. While maintaining all conditions shown in Figure 4L and the “Current status” indicates “EXECUTING”, shift the CVT into **D** and then wait until the Current status indicates “COMPLETED”.

NOTE: This may take up to three (3) minutes to complete.

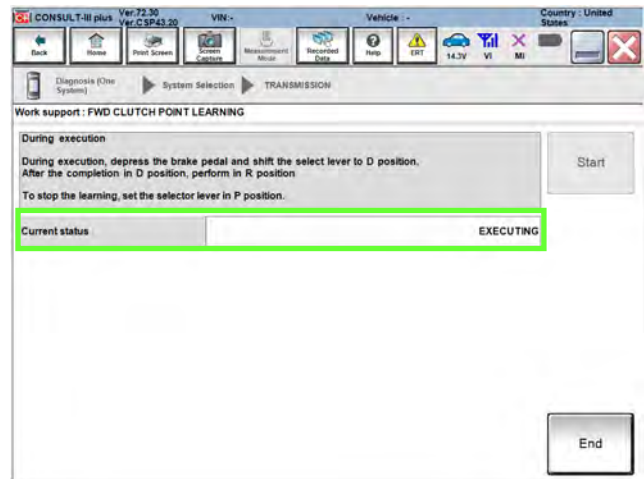

Figure 5L

12. When the screen in Figure 6L is displayed, select **End**.

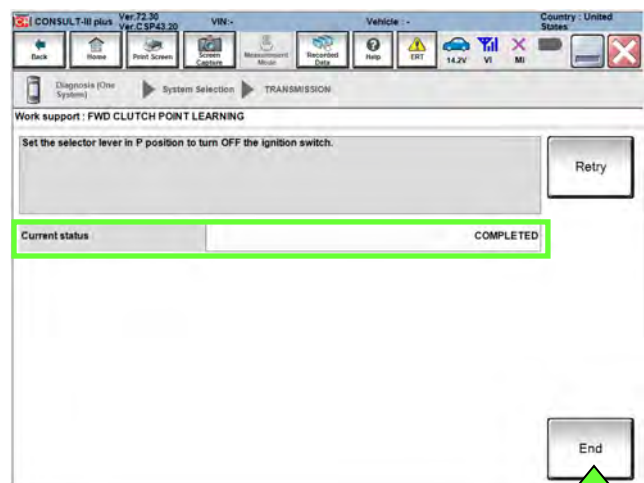

Figure 6L

13. Turn the engine OFF and then back ON.

14. Select **FWD CLUTCH POINT LEARNING** and then **Start**.

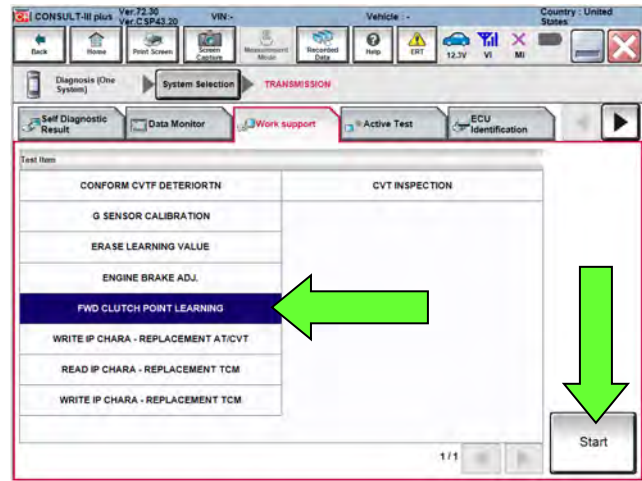

Figure 7L

15. With the engine still running and at idle, depress the brake pedal and shift the CVT into neutral (**N**).

- Confirm that all of the conditions indicated in Figure 8L are being met.

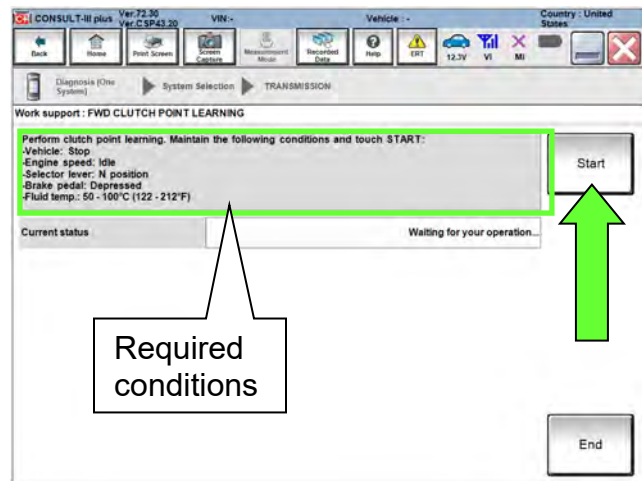

Figure 8L

16. Select **Start**.

17. While maintaining all conditions shown in Figure 8L and the Current status indicates EXECUTING, shift the CVT into **R** and then wait until the Current status indicates COMPLETED.

NOTE: This may take up to 3 minutes to complete.

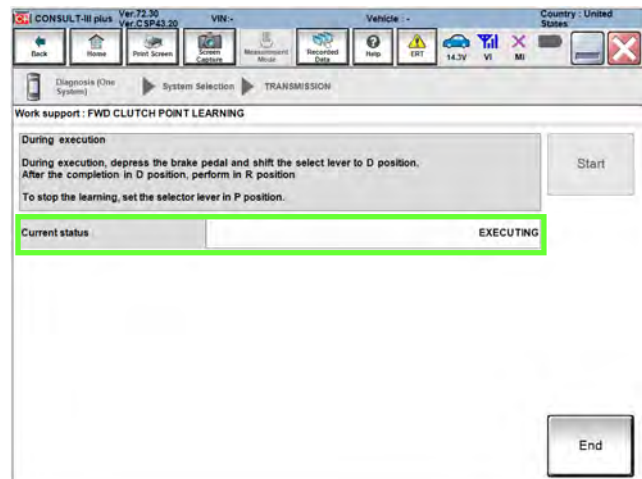

Figure 9L

18. When the screen in Figure 10L is displayed, select **End**.

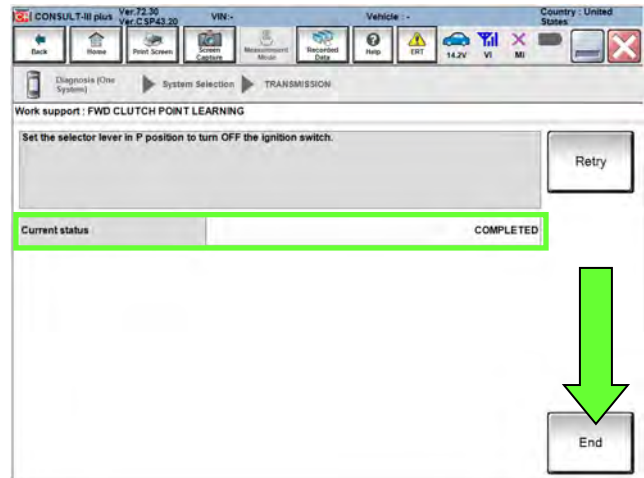

Figure 10L

SELECT LEARNING (DRIVE/REVERSE LEARNING)

Perform Select Learning (Drive / Reverse Learning) as follows:

1. Set the parking brake.
2. Start the engine, and then wait five (5) seconds.
3. Move the shift selector to the **N** position and hold more than two (2) seconds, and then move it to the **D** position and wait for transmission engagement.
4. Repeat step 3 ten times.
5. Move the shift selector to the **N** position and hold for more than 2 seconds, and then move it to the **R** position and wait for transmission engagement.
6. Repeat step 5 ten times.
7. Move the shift selector to the **P** position, and then turn the ignition OFF.

TROUBLE SHOOTING

The Dummy Cover Will Not Sit Flush

If the dummy cover does not sit flush, the clutch pack may not be fully seated.

- Figure 1M shows clutch pack fully seated.
- Clutch pack is not fully seated if it is not below the surface that the dummy cover bolts to.
- Use instructions below to fully seat clutch pack.

NOTE: Always handle the clutch pack by the input shaft.

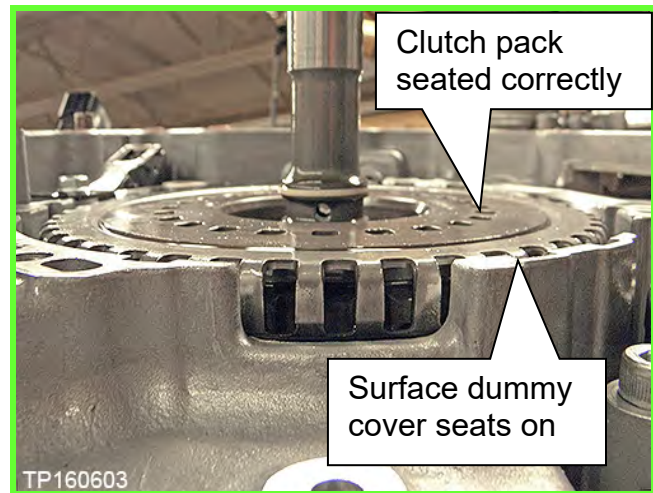

Figure 1M

1. Remove the dummy cover.

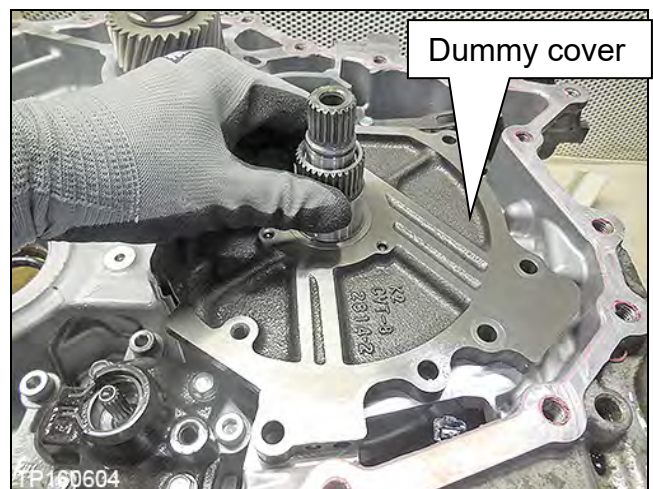

Figure 2M

2. Pull up the clutch pack by the input shaft to remove the entire clutch pack.
 - Make sure the O-ring is not installed at this time, or it could be damaged during reassembly.

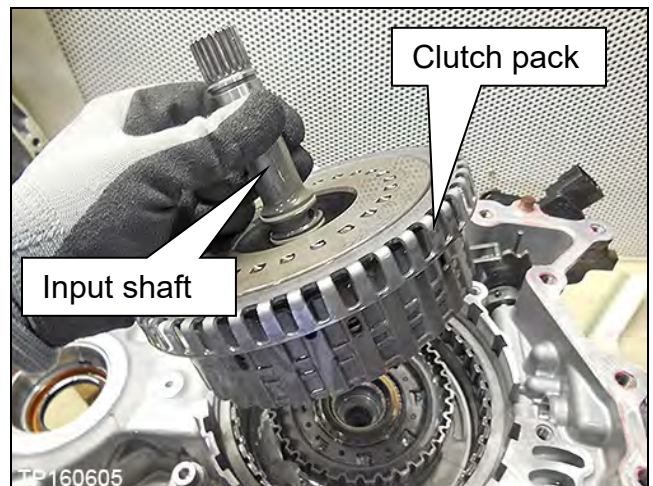

Figure 3M

3. Gently using an appropriate tool align the layers of the clutch pack.
 - Bottom of the clutch pack shown in Figure 4M.

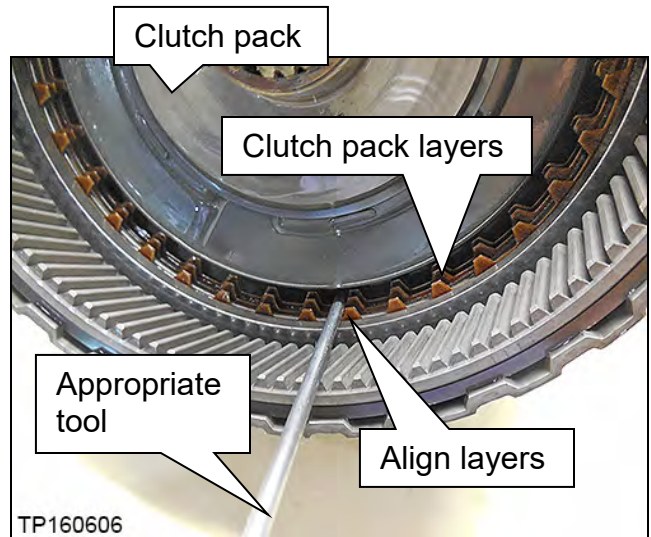

Figure 4M

4. Re-insert the entire clutch pack while holding the input shaft.
5. Gently jiggle the input shaft until the clutch pack seats below case lip.
6. If the clutch pack does not seat, rotate back and forth from the input shaft and jiggle.
7. If the clutch pack still does not seat, repeat from step 2.

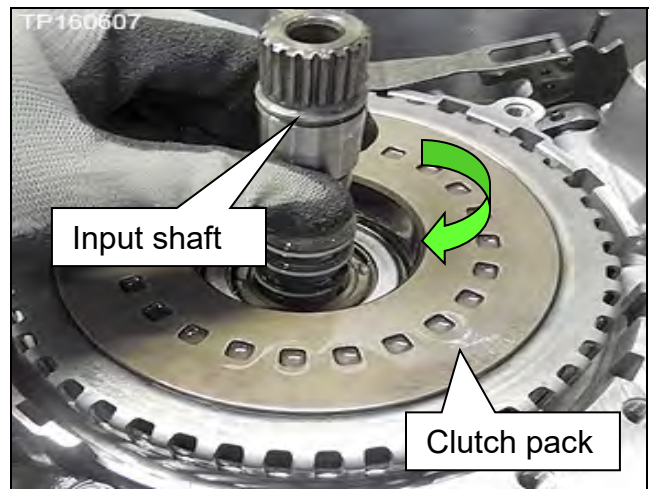

Figure 5M

PARTS INFORMATION

The following part kits are only to be used if the Sub-assembly is being replaced.

DESCRIPTION	PART #	QUANTITY	
BELT-PULLEY KIT	Altima	31214-28X9E	1
	Rogue	31214-28X9B	
CLAMP (Hose Spring Clamp)	16439-7S01E	2	
VALVE ASSY KIT-CONTROL (Valve body)	31705-28X9B	1	
Valve Assy Kit-Control includes:			
VALVE ASSEMBLY-CONTROL (5)		1	
STRAINER ASSY-OIL, AUTO TRANS		1	
BRACKET (Temperature sensor bracket)		1	
BAND (Zip tie for bracket)		1	
GSKT-OIL PAN		1	
SEAL-LIP (Between CVT and control valve)		1	
Seal, O-Ring (fluid filler plug gasket)		1	
SEAL-O RING (Transfer case to CVT AWD only)	33118-4BA0A	1	
WASHER-DRAIN (For drain plug)	11026-JA00A	1	
Loctite 5460 Sealant (1) (3)	999MP-LT5460P	(2)	
Nissan NS-3 CVT Fluid (1) (4)	999MP-CV0NS3	As needed	
Transmission Cooler Cleaner (1)	999MP-AM006P	As needed	

If just a Control Valve is being replaced, use the following parts.

DESCRIPTION	PART #	QUANTITY
VALVE ASSY KIT-CONTROL (Valve body)	31705-28X9B	1
CLAMP (Hose Spring Clamp)	16439-7S01E	2
Valve Assy Kit-Control includes:		
VALVE ASSEMBLY-CONTROL (5)		1
STRAINER ASSY-OIL, AUTO TRANS		1
BRACKET (Temperature sensor bracket)		1
BAND (Zip tie for bracket)		1
GSKT-OIL PAN		1
SEAL-LIP (Between CVT and control valve)		1
Seal, O-Ring (fluid filler plug gasket)		1
WASHER-DRAIN (For drain plug)	11026-JA00A	1
Nissan NS-3 CVT Fluid (1) (4)	999MP-CV0NS3	As needed
Transmission Cooler Cleaner (1)	999MP-AM006P	As needed

- (1) This item can be ordered through the Nissan Maintenance Advantage program: Phone: 877-NIS-NMA1 (877-647-6621) or Website: Order via link on dealer portal www.NNAnet.com and click on the "Maintenance Advantage" link.
- (2) One container of Loctite 5460 Sealant is good for approximately 5 repairs. This sealant is not included in any kit.
- (3) Bill out Loctite 5460 Sealant under **expense code 008**. Do not include the Loctite 5460 Sealant part number on the claim.
- (4) For warranty repairs, Nissan NS-3 CVT Fluid **must** be used. For customer pay repairs, Nissan NS-3 CVT Fluid or an equivalent is recommended.
- (5) Includes QR label, CD-R, and control valve assembly.

CLAIMS INFORMATION

IF Belt Inspection is not Performed and Sub-Assembly is replaced

Submit a Primary Part (PP) type line claim using the following claims coding:

MODEL	OPERATION	PFP	OP CODE	SYM	DIAG	FRT
All	CVT R&R	(1)	JD01AA	ZE	32	(2)
			JD023A			
Altima	Replace CVT Sub-assembly (includes control valve R&I)		JX50AA			3.7
Rogue						3.8
All	Reprogram TCM (when applicable)	JE99AA		(2)		

(1) Reference the Parts Information Table and use the applicable BELT-PULLEY KIT Part Number 31214-**** as the Primary Failed Part.

(2) Reference the current Nissan Warranty Flat Rate Manual and use the indicated Flat Rate Time.

NOTE: FRT allows adequate time to access DTC codes. No other diagnostic procedures subsequently required. Do NOT claim any diagnostic OP Codes with this claim.

EXPENSE CODE

EXPENSE CODE	DESCRIPTION	MAX AMOUNT
008	5460 Sealant	\$12.46

Claims Information continued on the next page.

Claims information continued.

OR

If Belt Inspection is Performed and Sub-Assembly is replaced (belt inspection shows signs of belt slip, NG)

Submit a Primary Part (PP) type line claim using the following claims coding:

MODEL	OPERATION	PFP	OP CODE	SYM	DIAG	FRT
All	CVT R&R	(1)	JD01AA	ZE	32	(2)
			JD023A			
Altima	Inspect CVT Chain, Chain = NG (Includes control valve R&I)		JX36AA			1.1
Rogue						
Altima	Replace CVT Sub-assembly		JX45AA			2.9
Rogue						3.0
All	Reprogram TCM (when applicable)	JE99AA	(2)			

(1) Reference the Parts Information Table and use the applicable BELT-PULLEY KIT Part Number 31214-***** as the Primary Failed Part.

(2) Reference the current Nissan Warranty Flat Rate Manual and use the indicated Flat Rate Time.

NOTE: FRT allows adequate time to access DTC codes. No other diagnostic procedures subsequently required. Do NOT claim any diagnostic OP Codes with this claim.

EXPENSE CODE

EXPENSE CODE	DESCRIPTION	MAX AMOUNT
008	5460 Sealant	\$12.46

OR

If Only Control Valve is replaced:

Submit a Primary Part (PP) type line claim using the following claims coding:

OPERATION	PFP	OP CODE	SYM	DIAG	FRT
Inspect CVT Chain, Chain = OK	(1)	JX37AA	ZE	32	0.3
Replace Valve Body		JD48AA			(2)
Reprogram TCM (When Applicable)		JE99AA			(2)

(1) Reference the Parts Information Table and use the VALVE ASSY KIT-CONTROL part number (31705-*****) as the Primary Failed Part.

(2) Reference the current Nissan Warranty Flat Rate Manual and use the indicated Flat Rate Time.

NOTE: FRT allows adequate time to access DTC codes. No other diagnostic procedures subsequently required. Do NOT claim any diagnostic OP Codes with this claim.

Check-off parts as they are used in the Service Procedure and attach to work order

PARTS KITS REFERENCE TABLE (Parts are listed in order of installation)

CHECK OFF	DESCRIPTION	PART #	QUANTITY	
	PUMP ASSY-OIL Kit 31340-28X8A includes:	PUMP ASSY-OIL	31340-28X0A	1
		SEAL-O RING	31526-28X0C	1 (of 7)
		RING-SNAP	31506-1XF12	1
	SEAL-O RING (O-ring between CVT case and side cover)	31526-28X0A	1	
	PULLEY ASSY - CVT (Belt and pulley "sub-assembly")	Altima	31209-28X9A	1
		Rogue	31209-28X9B	
	Loctite 5460 Sealant	999MP-LT5460P	As needed	
	BOLT	31377-1XD00 (or 31377-1XZ0B)	19 (of 42)	
	Rogue only	SEAL-O RING (For pulley retainer bolts)	31526-28X0C	6 (of 7)
	SEAL-OIL,DIFF (Differential side oil seal; CVT case side)	38342-3VX0A	1	
	BRG ASSY-THRUST NEEDLE (Thrust bearing)	See page 97	1	
	SEAL ASSY-OIL (Torque converter oil seal; converter housing)	31375-1XF00	1	
	SEAL-OIL,DIFF (Differential side oil seal; converter housing side, front wheel drive only)	38342-3VX0B	1	
	SEAL-O RING (For input shaft)	31526-80X01	1	
	Loctite 5460 Sealant	999MP-LT5460P	As needed	
	BOLT	31377-1XD00	23 (of 42)	
	FLTR ASSY-OIL,AUTO TRANS (CVT fluid filter)	31726-28X0A	1	
	SEAL-O RING (For filter cover)	31526-3VX0A	1	
	SEAL-LIP (Between CVT and control valve)	31528-1XZ0A	1	
	BRACKET (Temperature sensor bracket)	31069-3VX0D	1	
	VALVE ASSY-CONT (Valve body)	31705-28X0B	1	
	BAND (Zip tie for bracket)	24224-3VX0A	1	
	STRAINER ASSY-OIL, AUTO TRANS	31728-28X0A	1	
	GSKT-OIL PAN	31397-1XF0D	1	
	WASHER-DRAIN (For drain plug)	11026-JA00A	1	
	Seal O-Ring (Speed Sensor)	31526-1XG0C	1	
	Transmission Cooler Cleaner	999MP-AM006P	As needed	
	CLAMP (Hose Spring Clamp)	16439-7S01E	2	
	SEAL-O RING (CVT filler plug at converter housing)	31526-3VX0B	1	
	Nissan NS-3 CVT Fluid	999MP-CV0NS3	As needed	
	SEAL-O RING (Transfer case to CVT, AWD only)	33118-4BA0A	1	

DESCRIPTION	PART #: 31407-	BEARING THICKNESS	QTY
THRUST BEARING	1XZ0B	3.57	1 of each is included in the Pulley Kit. Select 1 for installation.
	1XZ0C	3.75	
	1XZ0D	3.93	
	1XZ0E	4.1	
	1XZ1A	4.28	
	1XZ1B	4.46	
	1XZ1C	4.61	
	1XZ1D	4.79	

PART KITS VISUAL REFERNECE

- The following Figures show the smaller components of KIT-PULLEY.
- KIT- CONTROL VALVE is not shown.



Figure H shows the assorted seals, O-rings, etc. in "KIT-PULLEY"

Figure I

PUMP ASSY-OIL parts



Figure J

BRG ASSY-THRUST NEEDLE parts

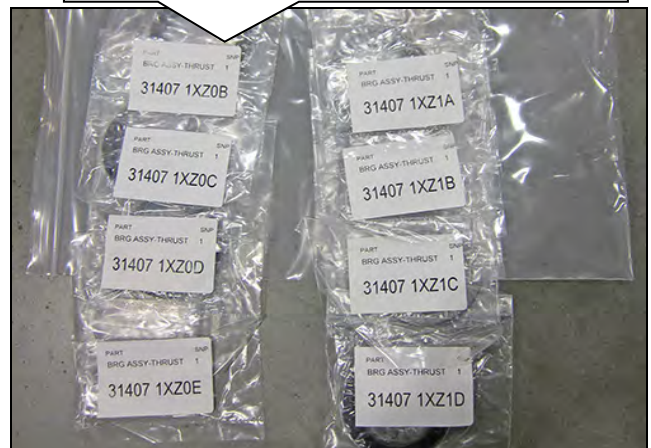

Figure K