

**TECHNICAL INSTRUCTIONS
FOR
LIMITED SERVICE CAMPAIGN FLB
CERTAIN 2010 MODEL YEAR RX 450h
OXYGEN SENSOR REPLACEMENT**

The repair quality of covered vehicles is extremely important to Lexus. All dealership technicians performing this LSC are required to successfully complete the most current version of the E-Learning course "Safety Recall and Service Campaign Essentials". To ensure that all vehicles have the repair performed correctly; technicians performing this LSC repair are required to currently hold at least one of the following certification levels:

- Senior Service Technician
- Senior Diagnostic Specialist
- Master Service Technician
- Master Diagnostic Specialist

I. OPERATION FLOW CHART

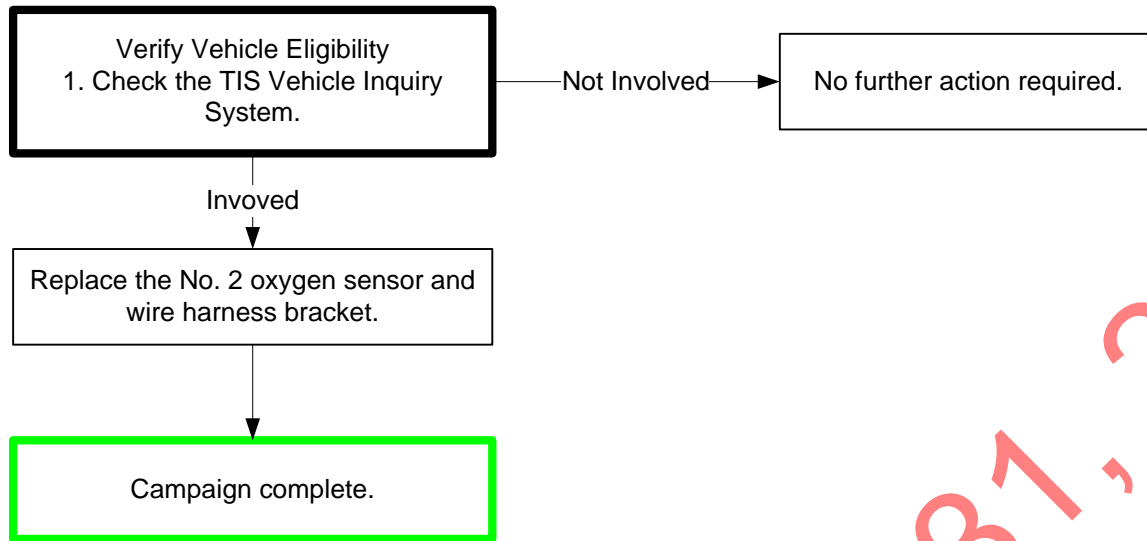

II. IDENTIFICATION OF AFFECTED VEHICLES

NOTE:

- Check the TIS Vehicle Inquiry System to confirm the VIN is involved in this LSC and that the campaign has not already been completed prior to dealer shipment or by another dealer.
- **TMS warranty will not reimburse dealers for repairs conducted on vehicles that are not affected or were completed by another dealer.**

III. PREPARATION

A. TOOLS & EQUIPMENT

- Standard Hand Tools
- Torque Wrench

Part Number	Part Name	Quantity
09617-24011*	Steering Rack Wrench	1

*This tool was provided to the dealer prior to launch of the LSC

B. PARTS

Part Number	Description	Quantity
04004-59148	OXYGEN SENSOR KIT	1

The kit contains the following:

Part Number	Description	Quantity
89465-48430	Oxygen Sensor	1
82715-48N90	Wire Harness Clamp Bracket	1
52161-16010*	Front Bumper Piece	2
90467-07201*	Clip	4

*To attach the engine under cover if the original pieces are damaged

IV. BACKGROUND

The subject vehicles are equipped with an oxygen sensor with an attached wire harness. Due to the oxygen sensor wire harness routing and engine vibration, the harness may become damaged over time. If the wire harness becomes damaged, the Check Engine warning lamp () may illuminate.

Lexus has designed a new oxygen sensor with a different wire harness and bracket to prevent this condition from occurring in the future.

NOTE: The check engine warning lamp can illuminate for other reasons not related to this Limited Service Campaign.

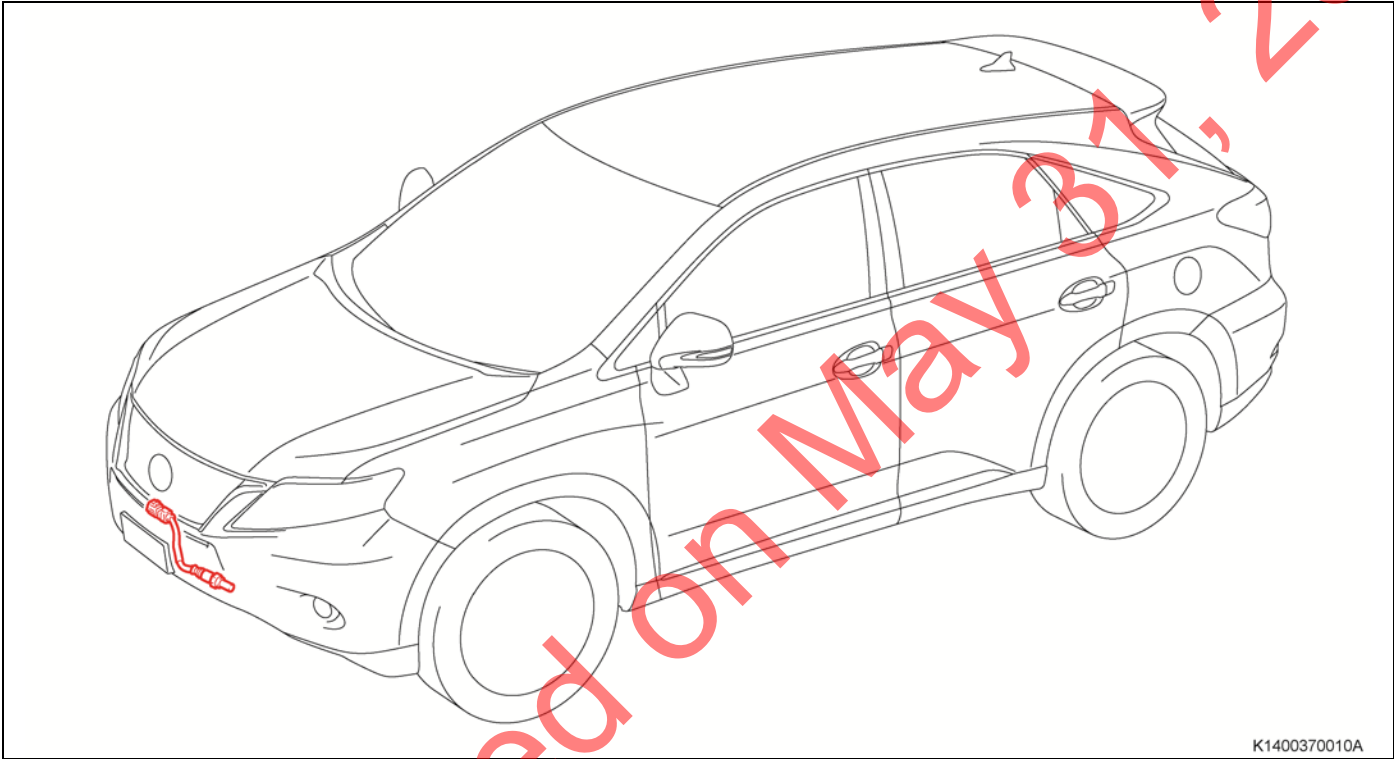

V. COMPONENTS

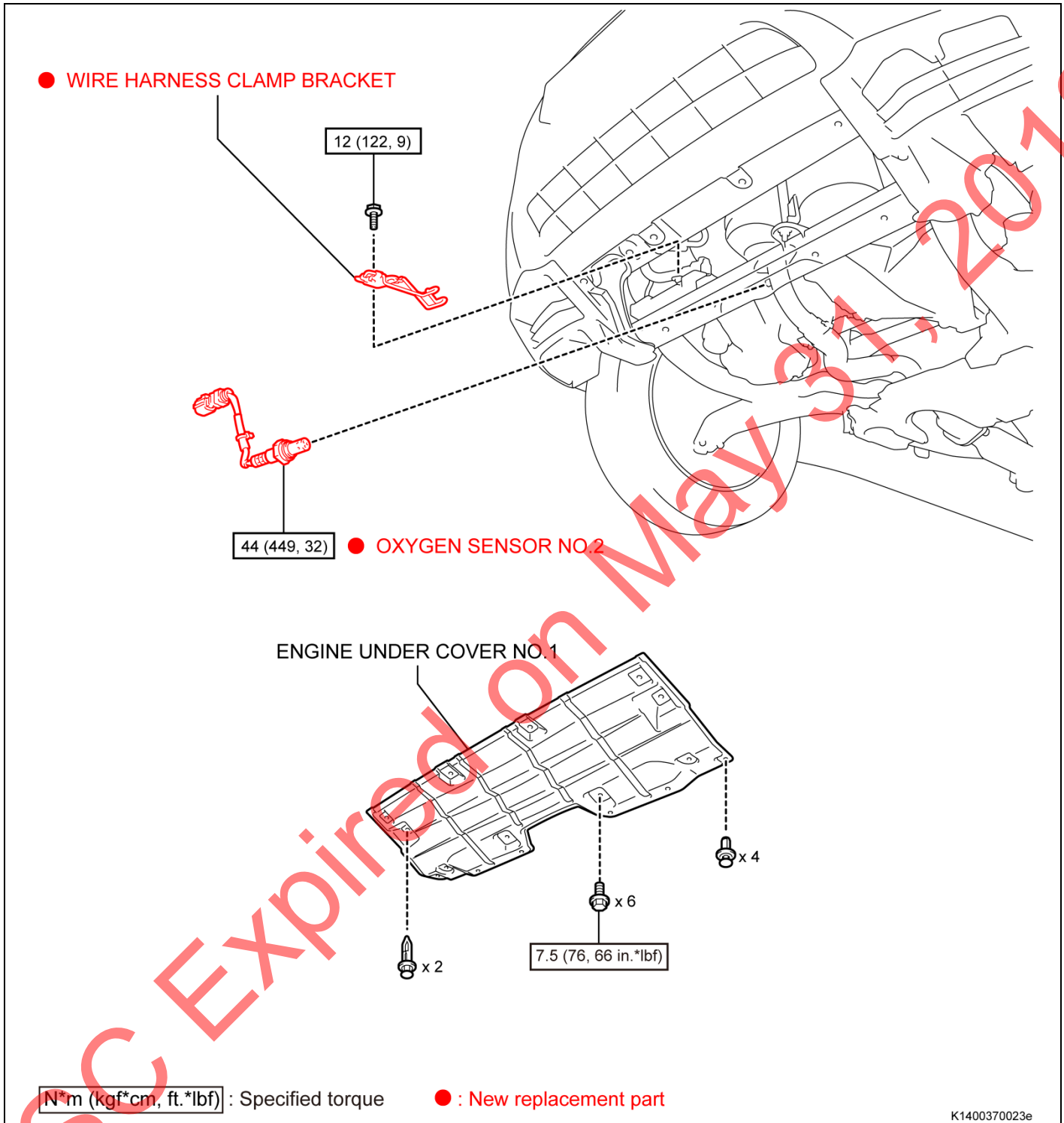

VI. WORK PROCEDURE

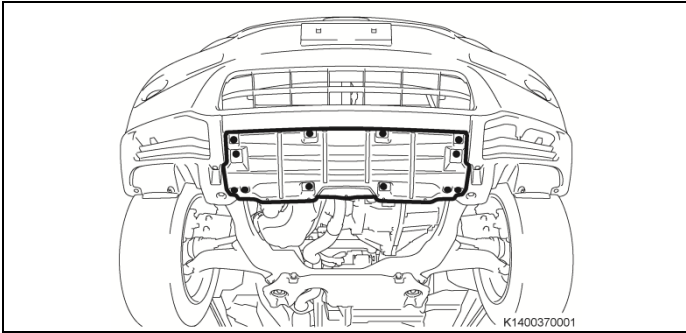

1. REMOVE No. 1 ENGINE UNDER COVER

- a) Remove the 6 bolts.
- b) Remove the 6 clips.
- c) Remove the No. 1 engine cover.

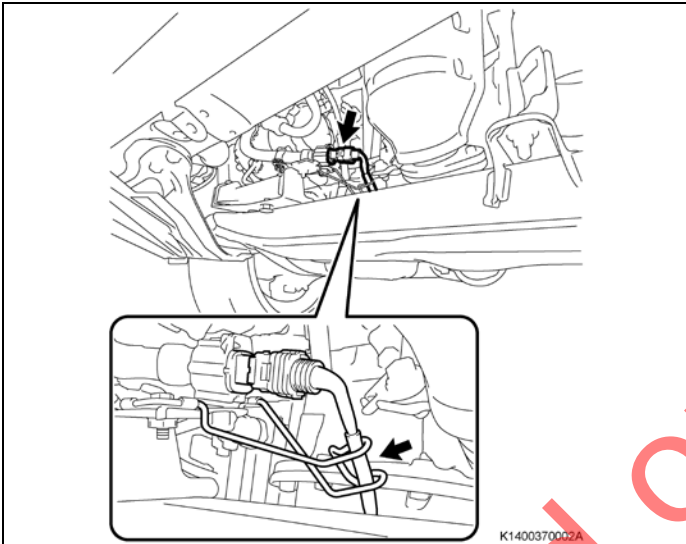

2. REMOVE THE No. 2 OXYGEN SENSOR

- a) Disconnect the harness connector.
- b) Remove the harness from the bracket.

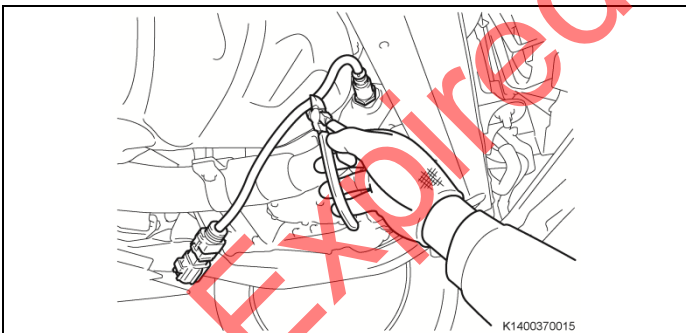

- c) Cut the harness near the sensor.

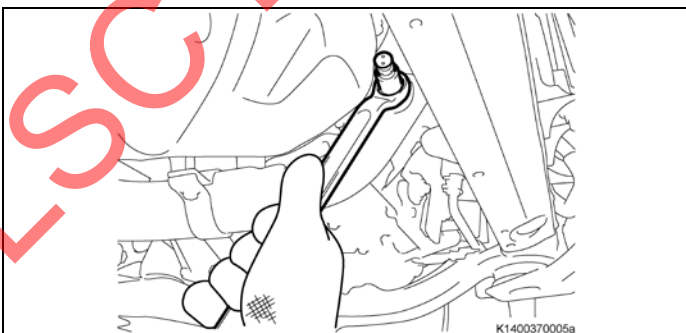

- d) Remove the No. 2 oxygen sensor.

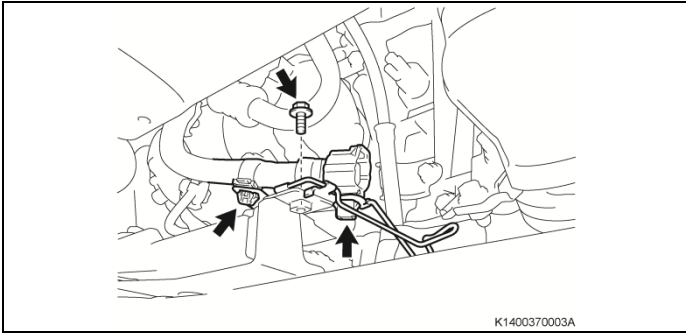

3. REMOVE THE HARNESS BRACKET

- a) Remove the 2 harness clamps from the bracket.
- b) Remove the bolt.

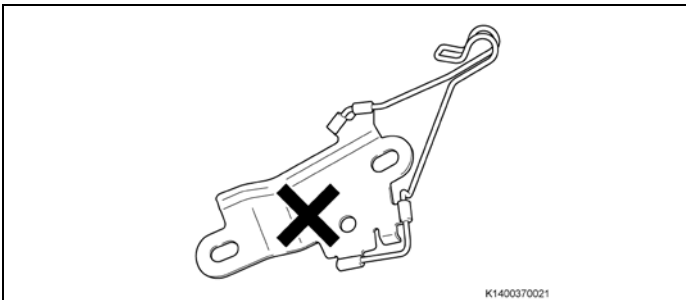

- c) Remove and discard the bracket.

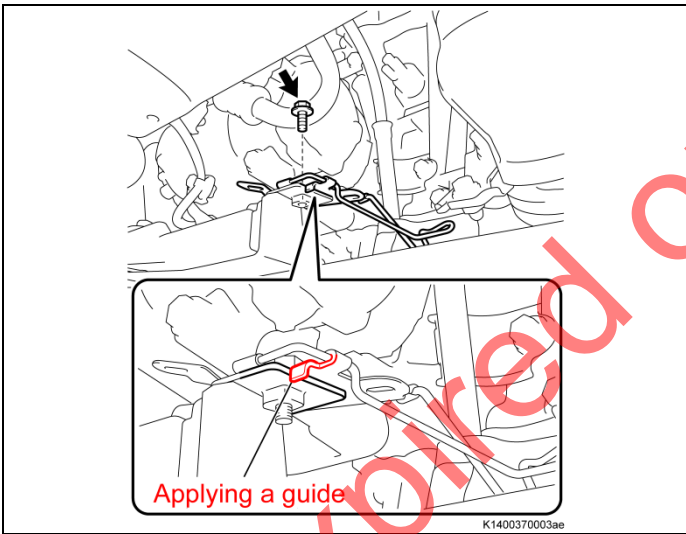

4. INSTALL THE NEW HARNESS BRACKET

- a) Install the new harness bracket and ensure that the guide is engaged into the stay as shown.
- b) Install the bolt.

TORQUE: 12 N*m (122 kgf*cm, 9 ft*lbf)

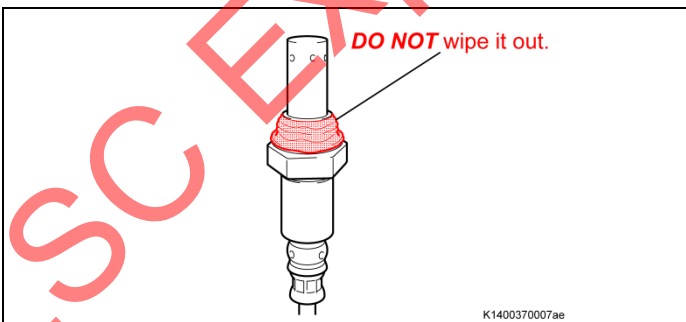

5. INSTALL THE NEW No. 2 OXYGEN SENSOR

STOP *DO NOT* remove the gray anti-seize coating on the threads of the new sensor.

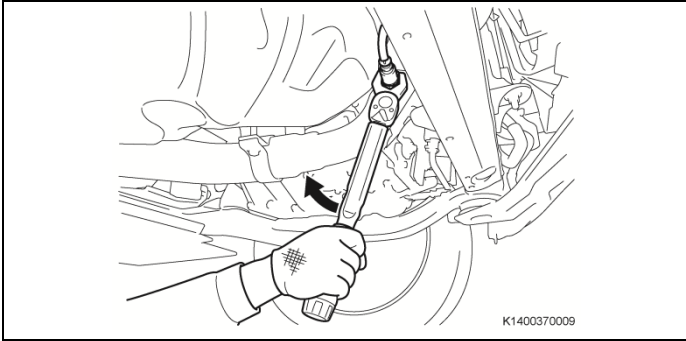

- a) Install the new sensor by hand until it seats.
- b) Tighten the sensor. using the SST.

SST: 09617-24011

TORQUE: 44 N*m (449 kgf*cm, 32 ft*lbf)

NOTE: Adjust torque wrench settings using the formula below if an extension is used.

Torque extension formula

<Formula> $T' = T * L2 / (L1 + L2)$

Connect straightforward

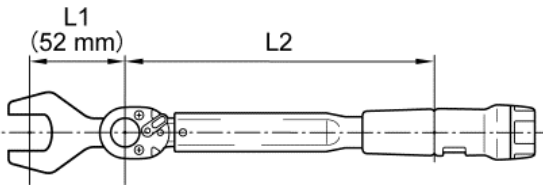

T'	Reading of torque wrench [N*m (kgf*cm, ft.*lbf)]
T	Torque [N*m (kgf*cm, ft.*lbf)] [44N·m (449 kgf*cm, 32 ft.*lbf)]
Extension L1	Length of SST or extension tool (steering rack wrench) [mm (in.)] [52 mm (2.05 in.)]
L2	Length of torque wrench [mm (in.)]

K1400370022e

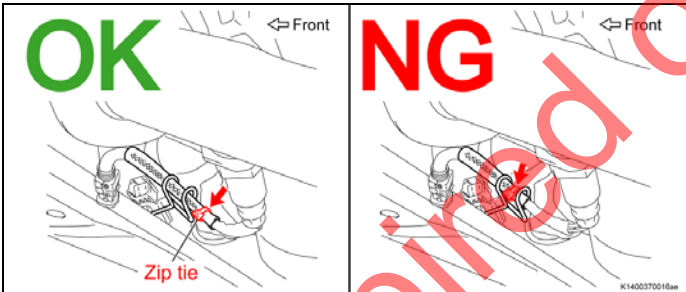

- c) Install the harness into the clamp and position as shown.

NOTE: DO NOT connect the sensor prior to routing the harness to prevent twisting.

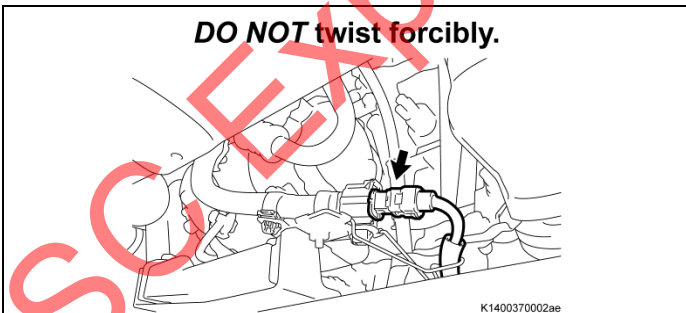

- d) Connect the sensor.

NOTE: Ensure the harness is not twisted or tensioned.

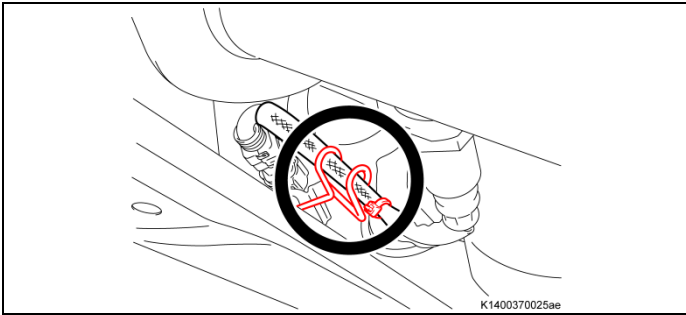

e) Recheck that the harness is still positioned properly.

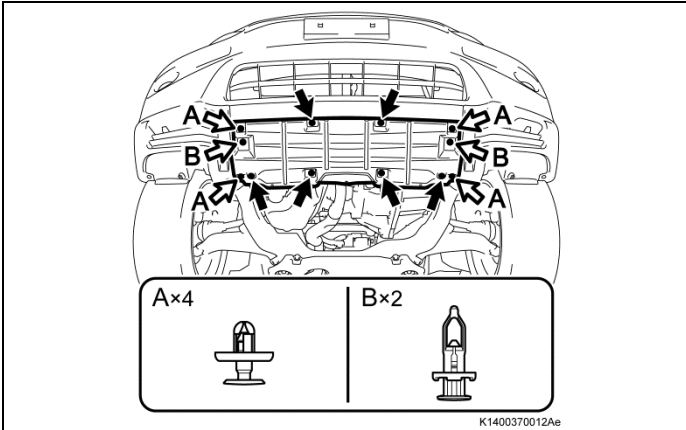

6. REINSTALL THE No. 1 ENGINE COVER

- a) Reinstall the engine cover.
- b) Reinstall the 6 clips.
- c) Reinstall the 6 bolts.

TORQUE: 7.5 N*m (76 kgf*cm, 66 in*lb)

NOTE: New bumpers and clips are provided in the sensor kit if needed.

◀ VERIFY REPAIR QUALITY ▶

If you have any questions regarding this campaign, please contact your area representative.

VII. APPENDIX

A. CAMPAIGN DESIGNATION DECODER

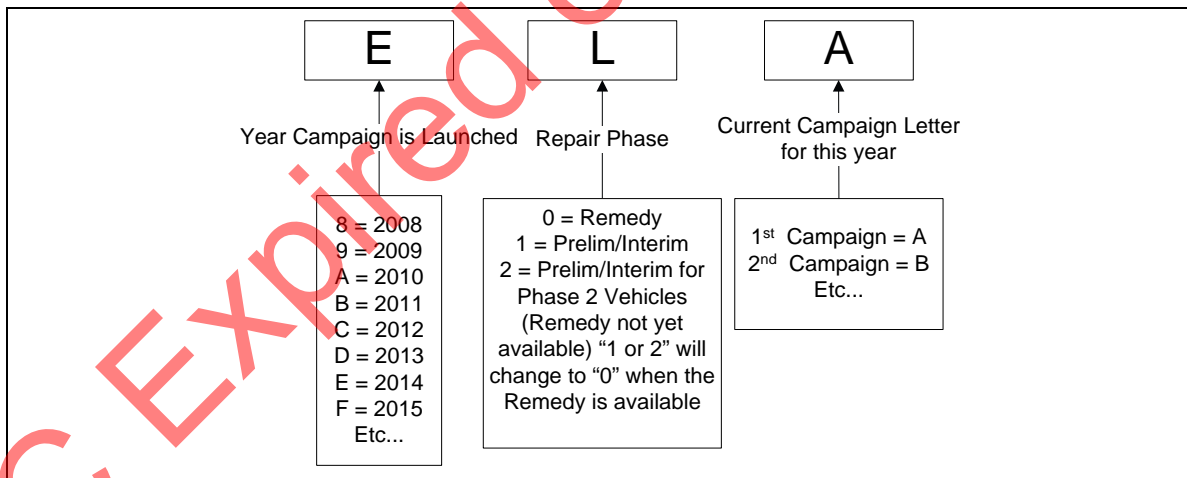

B. CAMPAIGN PARTS DISPOSAL

As required by Federal Regulations, please make sure all campaign parts (original parts) removed from the vehicle are disposed of in a manner in which they will not be reused, **unless requested for parts recovery return.**