

April 16, 2018

Version 1

Clicking from the Power Seat While Using the Height or Tilt Adjustment

AFFECTED VEHICLES

Year	Model	Trim	VIN Range
2014-18	MDX	ALL	ALL
2017-18	MDX Sport Hybrid	ALL	ALL
2015-18	TLX	ALL with 10-way driver's power seat	ALL
		ALL with 8-way passenger's power seat	

SYMPTOM

When adjusting seat height or tilt, the power seat does not move or moves just a small amount and clicks loudly during operation.

POSSIBLE CAUSES

The vertical transmission assembly (VTA) unit has a stripped internal gear.

CORRECTIVE ACTION

Replace the height adjust VTA unit and/or tilt adjust VTA unit.

CLIENT INFORMATION: The information in this bulletin is intended for use only by skilled technicians who have the proper tools, equipment, and training to correctly and safely maintain your vehicle. These procedures should not be attempted by "do-it-yourselfers," and you should not assume this bulletin applies to your vehicle, or that your vehicle has the condition described. To determine whether this information applies, contact an authorized Acura automobile dealer.

TOOL INFORMATION

Part Name	Tool Number	Quantity
Meshing Tool	07AAF-2GAA100	1
U-Joint Removal Tool - See note below before ordering.	OTC7248	1
Adapter G - See note below before ordering.	07XAF-001050B	1

NOTES

- The U-Joint Removal Tool and Adapter G can be substituted with a commercially available 6-inch C-clamp with a 1-inch foot.
- The U-Joint Removal Tool is a required dealer tool. If you need another one, call the Honda Tool and Equipment program at **888-424-6857**.

PARTS INFORMATION

NOTE

The VTA unit is universal. The same unit is used for either tilt or height.

Part Name	Part Number	Quantity
VTA Unit (Tilt or Height) for driver's side with memory seat (Includes grease and 3 nuts)	81603-T2F-A51	1
VTA Unit (Tilt or Height) for passenger's side with non-memory seat (Includes grease and 3 nuts)	81203-TZ3-A31	1

WARRANTY CLAIM INFORMATION

The normal warranty applies.

Warranty information for the driver's seat.

Operation Number	Description	Flat Rate Time	Defect Code	Symptom Code	Template ID	Failed Part Number
7491A5	Replace the height VTA unit.	1.0 hrs	01801	04202	B18014A	81603-T2F-A51
7491A3	Replace the tilt VTA unit.	1.0 hrs	01801	04202	B18014B	81603-T2F-A51
7491D8	Replace both VTA units.	1.1 hrs	01801	04202	B18014C	81603-T2F-A51

Warranty information for the passenger's seat.

7491A6	Replace the height VTA unit.	1.0 hrs	01801	04202	B18014D	81203-TZ3-A31
7491A4	Replace the tilt VTA unit.	1.0 hrs	01801	04202	B18014E	81203-TZ3-A31
7491D9	Replace both VTA units.	1.1 hrs	01801	04202	B18014F	81203-TZ3-A31

Skill Level: Repair Technician

INSPECTION

NOTES

- Before replacing a VTA unit, check which VTA unit is causing the noise and replace only the affected unit.
- In most cases, only one VTA unit is damaged. It is rare to replace both.

Height Adjust VTA

Adjust the seat height. If you hear a loud clicking or ratcheting from the seat height VTA unit and the height adjustment does not move very much, go to REPAIR PROCEDURE A (HEIGHT ADJUST VTA REPLACEMENT).

Tilt Adjust VTA

Adjust the seat tilt. If you hear a loud clicking or ratcheting from the seat tilt VTA unit and the tilt adjustment does not move very much, go to REPAIR PROCEDURE B (TILT ADJUST VTA REPLACEMENT).

SETTING UP THE MESHING TOOL

1. Make sure the set screws are installed on the meshing tool. If they are not installed, install them without passing through the inner cutout of the tool.

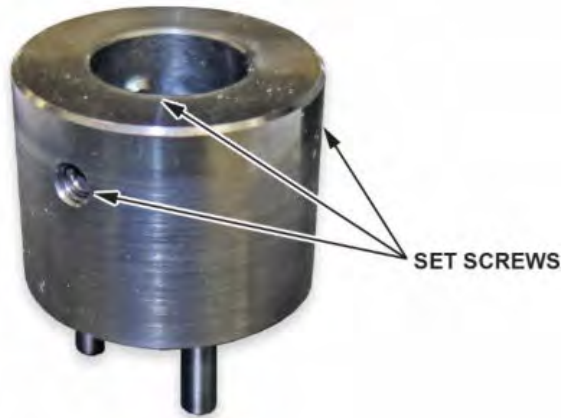

2. Install the meshing tool onto the U-Joint Removal Tool (T/N OTC7248) or universal 6-inch C-clamp. Hand tighten the set screws with a hex tool.

NOTE

If you are using a 6-inch C-clamp, the foot of the C-Clamp must be 1-inch in diameter for the meshing tool to fit correctly.

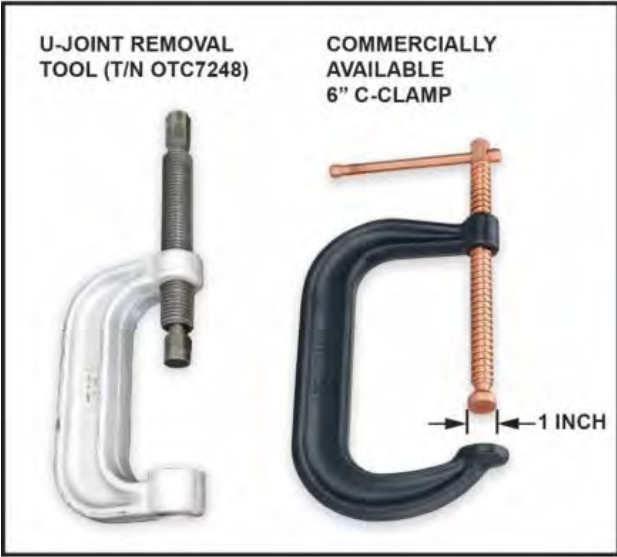

3. If you are using the U-Joint Removal Tool (T/N OTC7248), install Adaptor G (T/N 07XAF-001050B).



REPAIR PROCEDURE A (HEIGHT ADJUST VTA UNIT REPLACEMENT)

⚠ CAUTION

Be careful; there are many sharp edges. Wear protective gloves. Always wear protective eyewear when using a hammer or impact tools.

1. Turn the ignition switch to the ON position and check if the SRS indicator comes on for about 6 seconds, then turns off.
 - If the indicator comes on, then turns off after about 6 seconds, go to step 2.
 - If the indicator does not come on, or if it stays on, check the SRS DTC and record it.
2. Adjust the seat to the highest position possible, then lower by about 1/2 inch.
3. Disconnect the battery negative cable and wait at least 3 minutes before continuing.
4. Remove the affected seat and seat cushion cover/pad. Refer to the service information for the model and model year you are working on.

NOTES

- Do not remove the cushion cover from the foam pad. Remove both parts as an assembly.
- For reference during assembly, take a photo of the harness routing and clip location layout as shown.
- MDX Ventilated Driver's Seat is shown. It may differ slightly from the seat you are repairing.

Bottom of seat:



Top of seat:



5. Remove the seat ventilator from seat bottom (if equipped).

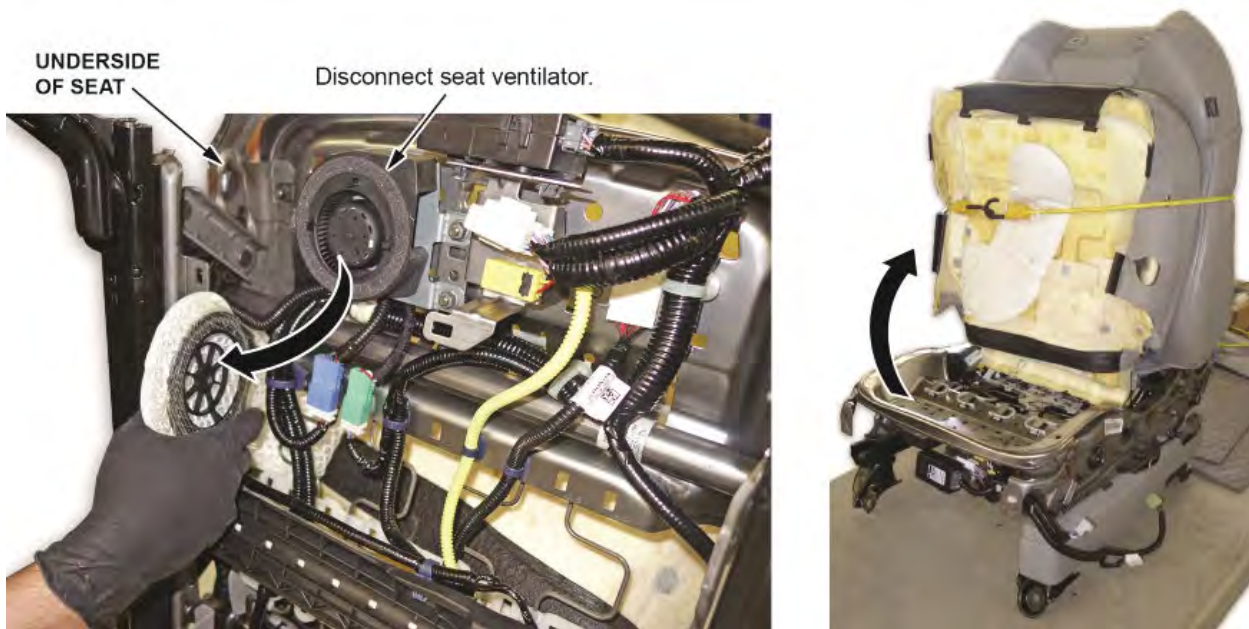

6. Remove any harnesses or harness clips that will prevent removal of the cushion pan.
7. Remove the four 10 mm bolts from the front cushion pan.



- Lift the cushion pan, and hold it up with a bungee cord or set the seat on its back on a clean surface to keep the cushion pan out of the way.
- Disconnect the VTA unit connector.



- Remove the VTA unit nuts, then remove the VTA unit.

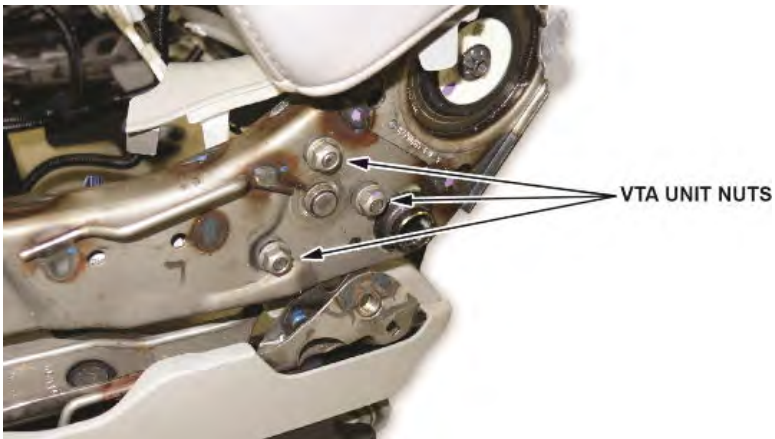

NOTES

- If the seat frame is too low and you cannot access the VTA unit nut, use an open end wrench.
- If it is difficult to remove the VTA unit after removing the nuts, hit the center shaft of the VTA unit with a punch tool and hammer to remove it.



11. Raise the seat as much as possible by pulling the seat frame as shown. This allows easier meshing of the gear teeth when installing the new VTA motor.

NOTE

The photo below shows how the seat should look after it is raised.

Grasp the seat frame.



Pull upward while holding the base down.

⚠ CAUTION

Place a hammer handle (or similar tool) between the upper and lower sections of the seat frame to prevent the rear of the frame from collapsing and pinching fingers. Remove the blocking hammer **ONLY** when you have installed and aligned the new VTA motor.



Prop open the gap between the upper and lower frame sections.

12. Wipe off any excess grease from the seat frame gear teeth with a paper towel or clean rag.

SEAT FRAME GEAR
Wipe this area.



13. Apply the provided grease to the new VTA unit motor splines.

NOTE

Only 1/8th of the grease packet is needed. Do not use the whole packet.

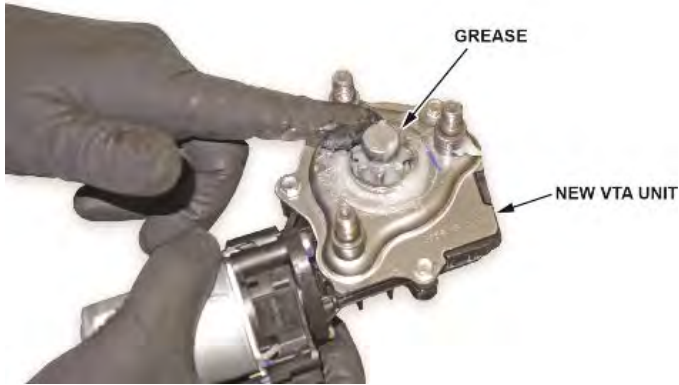

14. Mount the new VTA unit onto the seat frame.



15. While applying pressure to keep the VTA unit against the seat frame, use a rubber mallet or plastic hammer to hit the frame downwards. This will allow the VTA unit splines to align and engage with the frame gear.

Press the VTA unit against the frame.



Hit the frame downward.



16. Make sure the VTA unit splines and seat frame gear are properly engaged. The VTA unit center shaft should be protruding from the frame.

NOTES

- You may need to adjust or remove the blocking hammer handle if it is preventing proper gear engagement.
- Use caution as the seat will **NOT** be fully supported and may collapse or pinch fingers until the new VTA unit is secured to the seat frame.

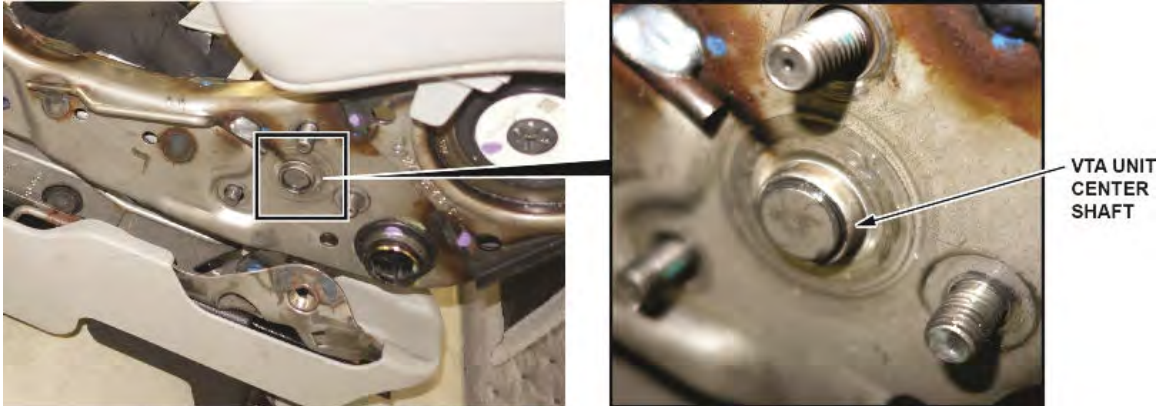

17. Place the meshing tool as shown. Center the tool on the pinion shaft protruding from the VTA unit.

NOTICE

- **DO NOT** over tighten the C-clamp.
- **DO NOT** attempt to install the VTA unit without using the meshing tool. Seating the VTA unit by tightening the nuts will damage the VTA unit.



Place the tool on the pinion shaft of the VTA unit.

18. Gradually tighten the C-clamp until the VTA unit shaft is protruding out of the frame. Once the VTA unit shaft is protruding, go to the next step.

NOTICE

- **DO NOT** over tighten the C-clamp.
- **DO NOT** attempt to install the VTA unit without using the meshing tool. Seating the VTA unit by tightening the nuts will damage the VTA unit.

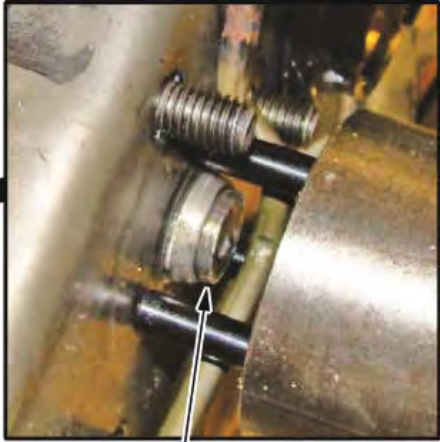

Tighten the tool until the VTA unit shaft protrudes.

19. With the C-clamp still in place, install the new VTA unit nuts and snug them with a wrench.



20. Remove the C-clamp, and torque the nuts to **25 N•m (18 lb-ft)**.



VTA UNIT NUTS
25 N•m (18 lb-ft)

21. Make sure the VTA unit is supporting the seat's weight, then remove the blocking hammer or tool.
22. Connect the VTA unit connector.
23. Lower the seat cushion pan, and install the bolts. Torque the bolts to **6.7 N•m (5 lb-ft)**.

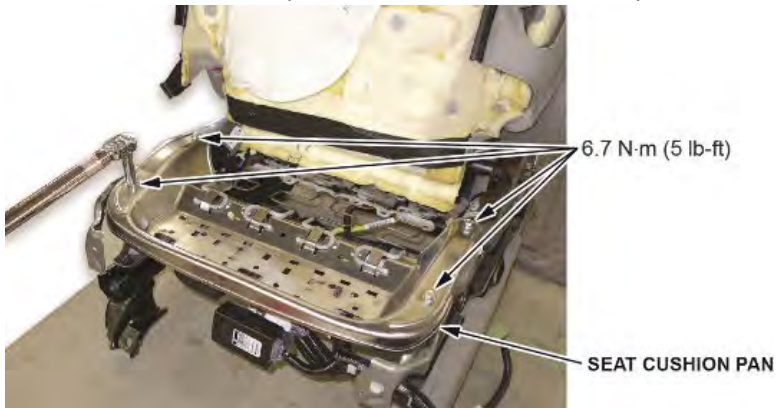

24. Route and install the harnesses and the harness clips.

NOTE

Make sure the routing is correct by looking at the photo you took before disassembly.

25. Install all other removed parts in the reverse order of removal, and install the seat.
26. Reconnect the battery.
27. If you are repairing a driver's seat, clear the driving position memory as outlined in the service information.
28. Make sure the height and tilt functions on the seat work properly and the noise is gone.
29. Turn the ignition switch to the ON position and check if the SRS indicator comes on for about 6 seconds, then turns off.
 - If the indicator comes on, then turns off after about 6 seconds, the procedure is complete.
 - If the SRS indicator did not perform correctly at the beginning of the procedure, check to see if the same problem exists. If there are additional problems, make sure all of the reassembly steps were completed.

REPAIR PROCEDURE B (TILT ADJUST VTA UNIT REPLACEMENT)

⚠ CAUTION

Be careful; there are many sharp edges. Wear protective gloves. Always wear protective eyewear when using a hammer or impact tools.

1. Turn the ignition switch to the ON position and check if the SRS indicator comes on for about 6 seconds, then turns off.
 - If the indicator comes on, then turns off after about 6 seconds, go to step 2.
 - If the indicator does not come on, or if it stays on, check the SRS DTC and record it.
2. Adjust the seat to the highest position possible.
3. Disconnect the battery negative cable and wait at least 3 minutes before continuing.
4. Remove the affected seat and seat cushion cover/pad. Refer to the service information for the model and model year you are working on.

NOTES

- Do not remove the cushion cover from the foam pad. Remove both parts as an assembly.
- For reference during assembly, take a photo of the harness routing and clip location layout as shown.
- MDX Ventilated Driver's Seat is shown. It may differ slightly from the seat you are repairing.

Bottom of seat:



Top of seat:



5. Remove the seat ventilator from the seat bottom (if equipped).

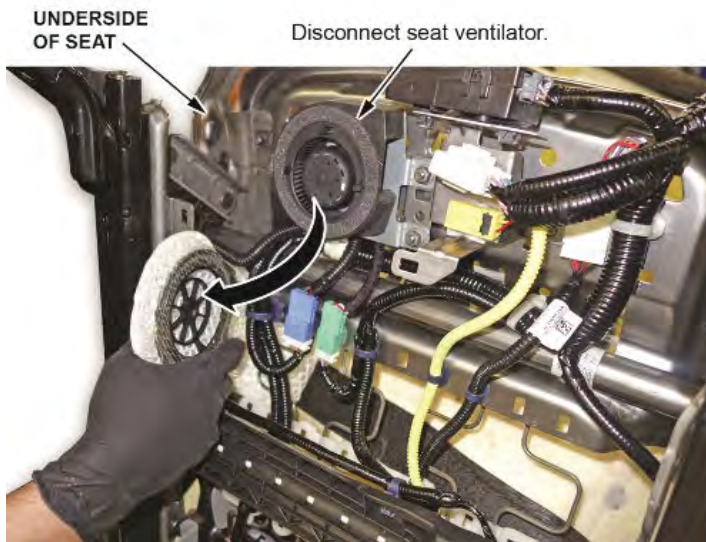

6. Remove any harnesses or harness clips that will prevent the removal of the cushion pan.
7. Remove the four 10 mm bolts from the front cushion pan.

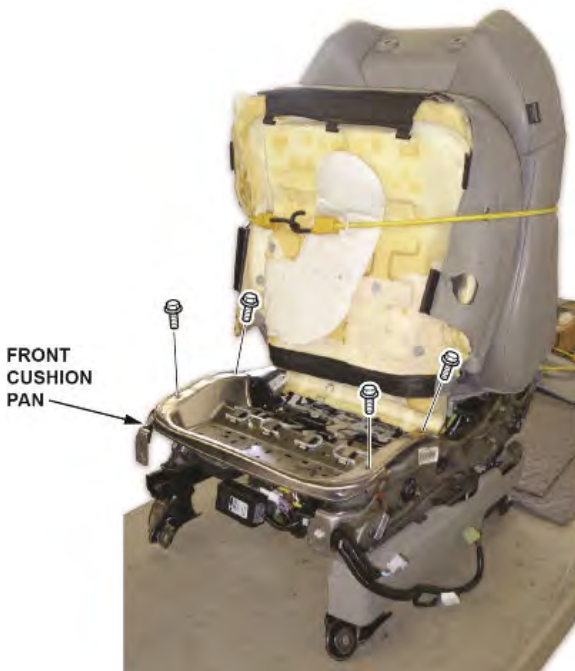

8. Lift the cushion pan, and hold it up with a bungee cord or set the seat on its back on a clean surface to keep the cushion pan out of the way.

9. Disconnect the VTA unit connector.

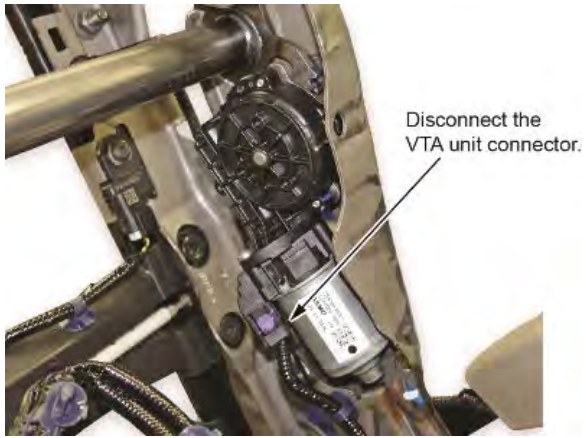

10. Remove the VTA unit nuts.

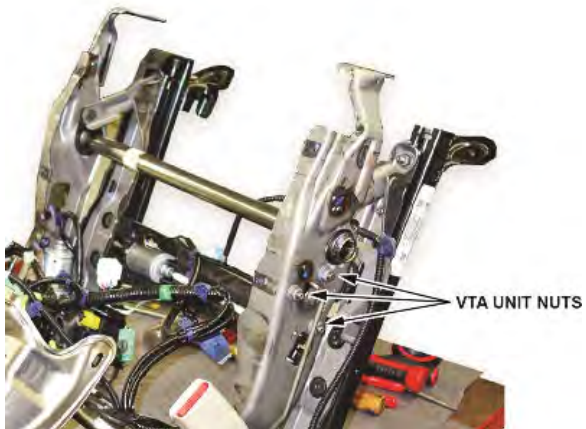

11. Remove the metal screw clip on top of the VTA unit with a clip removal tool.

NOTE

Make sure you do not damage or lose the metal screw clip.

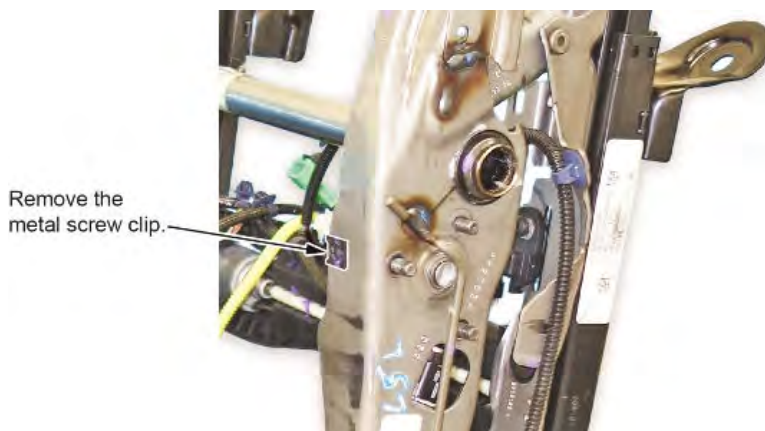

12. Remove the VTA unit.

NOTE

If it is difficult to remove the VTA unit after removing the nuts, hit the center shaft of the VTA unit with a punch tool and hammer to remove it.

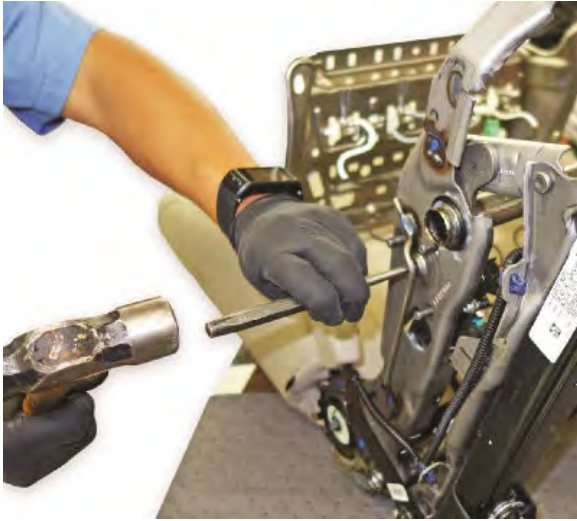

13. Raise the seat as much as possible by grabbing the seat frame as shown. This allows easier meshing of the gear teeth when installing the new VTA motor.

CAUTION

Place a hammer handle (or similar tool) between the upper and lower sections of the seat frame to prevent the rear of the frame from collapsing and pinching fingers. Remove the blocking hammer **ONLY** when you have installed and aligned the new VTA motor.



Prop open the gap between the upper and lower frame sections.

14. Wipe off any excess grease from the seat frame gear teeth with a paper towel or clean rag.

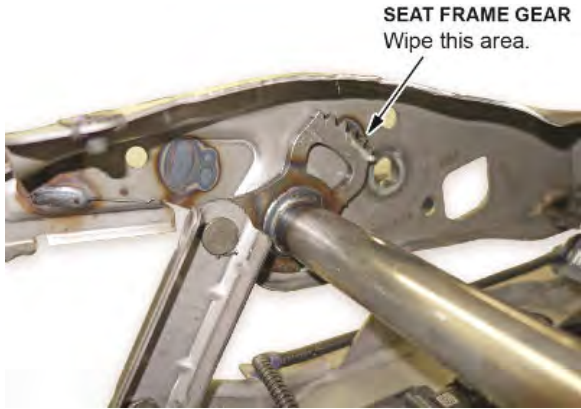

15. Apply the grease provided in the kit to the new VTA unit splines.

NOTE

Only 1/8th of the grease packet is needed. Do not use the whole packet.



16. Mount the new VTA unit to the seat frame.



17. While applying pressure to keep the VTA unit against the seat frame, use a rubber mallet or plastic hammer to hit the frame downwards. This will allow the VTA unit splines to align and engage with the frame gear.

Press the VTA unit against the frame.



Hit the frame downward.

18. Make sure the VTA unit splines and seat frame gear are properly engaged. The VTA unit center shaft should be protruding from the frame.

NOTES

- You may need to adjust or remove the blocking hammer handle if it is preventing proper gear engagement.
- Use caution as the seat will **NOT** be fully supported and may collapse or pinch fingers until the new VTA unit is secured to the seat frame.

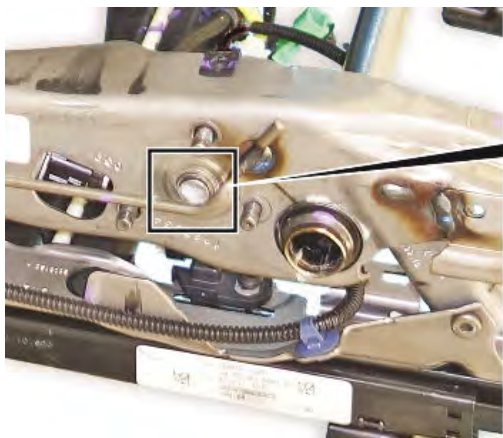

VTA UNIT
CENTER SHAFT

19. Place the meshing tool as shown. Center the tool on the pinion shaft protruding from the VTA unit.

NOTICE

- **DO NOT** over-tighten the C-clamp.
- **DO NOT** attempt to install the VTA unit without using the meshing tool. Seating the VTA unit by tightening the nuts will damage the VTA unit.



Place the tool on the pinion shaft of the VTA unit.



20. Gradually tighten the C-clamp until the VTA unit shaft is protruding from the frame. Once the VTA unit shaft is protruding, go to the next step.

NOTICE

- **DO NOT** over-tighten the C-clamp.
- **DO NOT** attempt to install the VTA unit without using the meshing tool. Seating the VTA unit by tightening the nuts will damage the VTA unit.

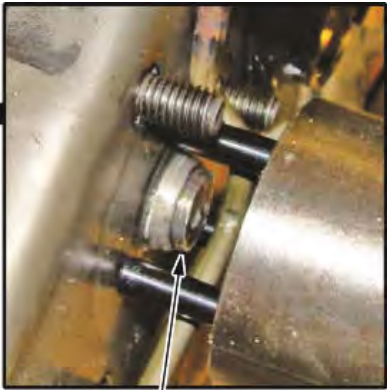
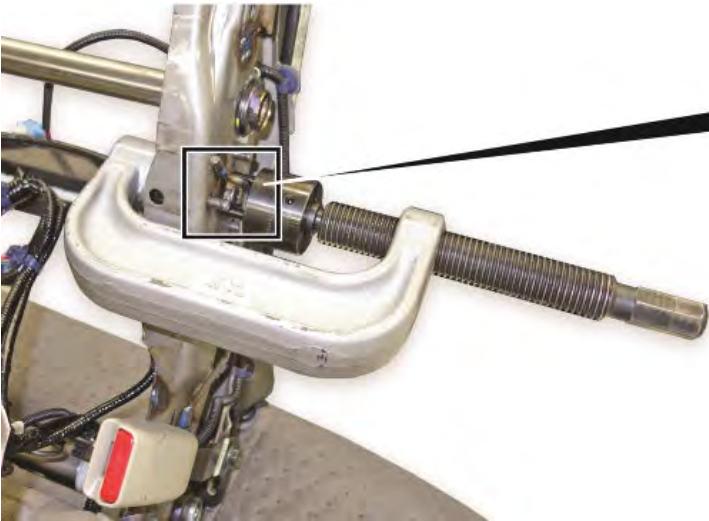

Tighten the tool until the VTA unit shaft protrudes.

21. With the C-clamp still in place, install the new VTA unit nuts and snug them with a wrench.

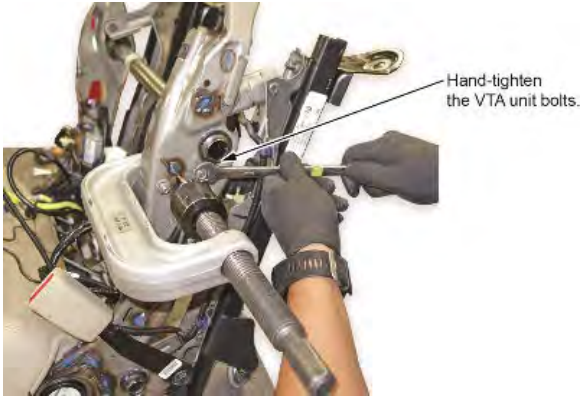

22. Remove the C-clamp, and torque the nuts to **25 N•m (18 lb-ft)**.

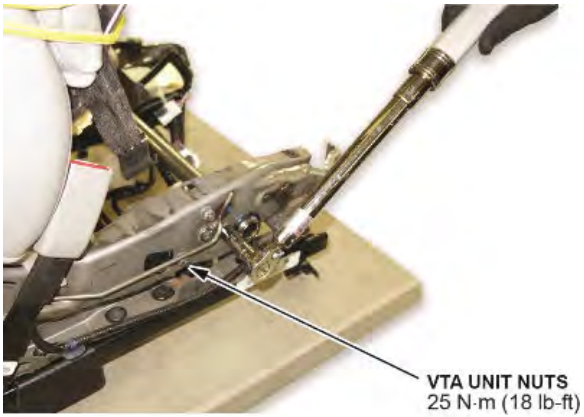

23. Install the metal screw clip.



24. Make sure the VTA unit is supporting the seat's weight, then remove the blocking hammer or tool.

25. Connect the VTA unit connector.

26. Lower the seat cushion pan, and install the bolts. Torque the bolts to **6.7 N•m (5 lb-ft)**.

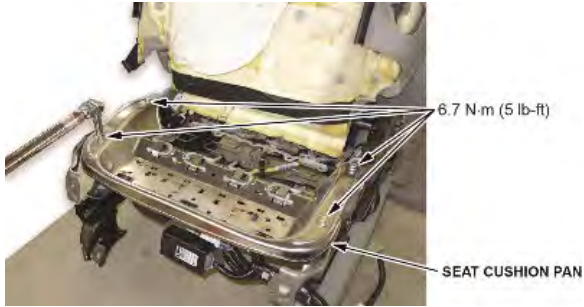

27. Route and install the harnesses and the harness clips.

NOTE

Make sure the routing is correct by looking at the photo you took before disassembly.

28. Install all other removed parts in the reverse order of removal, and install the seat.

29. Reconnect the battery.

30. If you are repairing a driver's seat, clear the driving position memory as outlined in the service information.

31. Make sure the height and tilt functions on the seat work properly and the noise is gone.

32. Turn the ignition switch to the ON position and check if the SRS indicator comes on for about 6 seconds, then turns off.

- If the indicator comes on, then turns off after about 6 seconds, the procedure is complete.
- If the SRS indicator did not perform correctly at the beginning of the procedure, check to see if the same problem exists. If there are additional problems, make sure all of the reassembly steps were completed.

END