

Engine Control Module (ECM) and  
Aftertreatment Control Module (ACM),  
Reprogramming  
VN, VAH, VHD

## **FSB 284-067, Engine Control Module (ECM) and Aftertreatment Control Module (ACM), Reprogramming**

(March 2018)

### **Information**

Software updates with enhancements are available for the engine control module (ECM) and aftertreatment control module (ACM) for VOLVO D11, D13 and D16 engines on OBD2017 and OBD2018 vehicles built from January 1, 2017 to March 01, 2018.

Follow the reprogramming procedure in the following order as outlined in this document:

- ECM reprogramming
- ACM reprogramming

The software updates address the following Diagnostic Trouble Codes (DTCs):

- P0420 – Catalyst System Efficiency Below Threshold
- P02FA – Diesel Intake Air Flow Position Sensor Minimum / Maximum
- P24DA – Particulate Matter Sensor Exhaust Sample Error Bank 1
- P009E – Fuel Pressure Relief Control Performance / Stuck Off
- P0471 – Engine Exhaust Back Pressure Circuit Range/Performance
- P1031 – Particulate Matter Sensor Clogged Tip

Check the current main software for ECM and ACM to determine the action required as shown in the table below.

<b>Action Required</b>		
<b>ECM</b>	<b>Main Software</b>	<b>Action Required</b>
D11 / D13	Equal or Less Than 23242993	Update to Latest Software
D16	Equal or Less Than 22898389	Update to Latest Software
<b>ACM</b>	<b>Main Software</b>	<b>Action Required</b>
D11 / D13 / D16	Equal or Less Than 22939083 (D11) 22953199 (D13) 22825019 (D16)	Update to Latest Software

## Required Tools

Premium Tech Tool (PTT) version 2.06.35 or higher

VOCOM Diagnostic Connector 88890304

Communication Interface 88890300

**Note:** Using other interfaces may affect programming speed.

**Note:** Check Premium Tech Tool version by clicking on Help tab and then click on "About Tech Tool".

## Software Update Procedure

You must read and understand the precautions and guidelines in Service Information, group 20, "General Safety Practices, Engines" before performing this procedure. If you are not properly trained and certified in this procedure, ask your supervisor for training before you perform it.



### DANGER

Do not attempt to repair or service this vehicle without having sufficient training, the correct service literature and the proper tools. Failure to follow this could make the vehicle unsafe and lead to serious personal injury or death.

- 1 Park the vehicle on a level surface.
- 2 Apply the parking brake.
- 3 Place the transmission in neutral or park.
- 4 Install the wheel chocks.

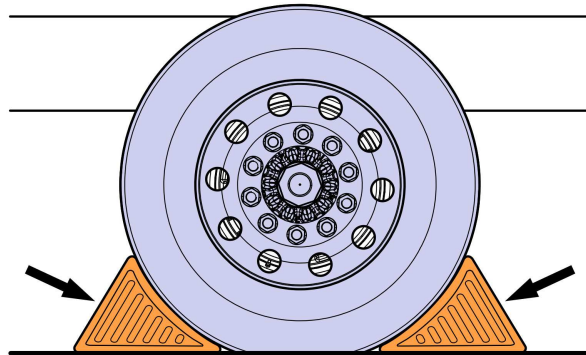

W7086748

- 5 Connect Premium Tech Tool (PTT) to the vehicle diagnostics connector using the 16 pin OBD cable 88890304 and Communication Interface 88890300. Connect the PC to a functional LAN or modem connection and a 120 Volt AC source.

- 6 Turn the ignition switch “**ON**”.
- 7 Log in to PTT and Identify Vehicle is displayed.
- 8 Once the vehicle has been identified, enter the Work Order Number information, then click Start Work.

Work Order Number

Enter a work order number or select a recently used work order number in the list.

Enter work order number:

Select a recently used work order:

Work Order No	User ID	Date
---------------	---------	------

Enter Notes:

Start Work Cancel

W2115477

- 9 From the Main Menu select Program and **then** Program Electronic Control Unit 1700-08-03-39. Then click Start.

Tech Tool

Tech Tool Links Help

Product Product History Diagnose Test Calibrate **Program** Impact

**Program**

Select an operation and click Start

- 1700-08-03-39 Program Electronic Control Unit**
- 1700-22-03-03 Parameter, programming
- 1700-22-03-28 Accessory Kit
- 1700-22-03-12 Replace Electronic Control Unit
- 1700-22-03-13 Program with Stored Software
- 1700-08-03-40 Handle Component
- 2841-22-03-04 Create Engine Label
- 3810-22-03-10 Change Language

W2115478

10 Select **Engine Control Module (EMS)**.

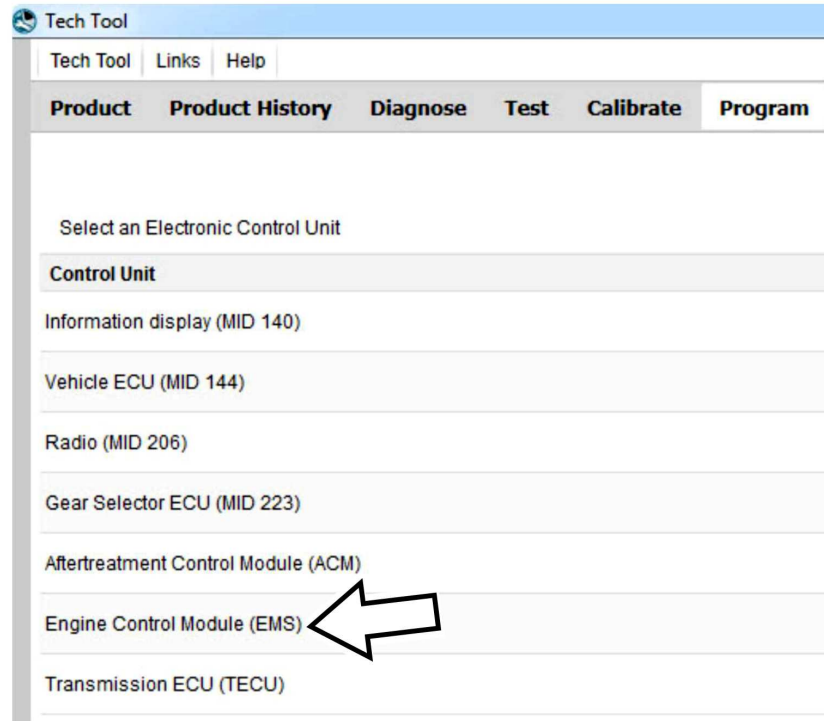

W2115479





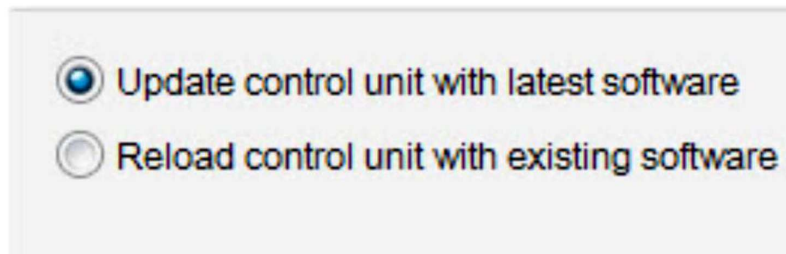





11 Select Program to update the **ECM** with the latest software.

## Programming options



W2115480

12 Certain conditions must be met to continue with programming: battery voltage above 10v, parking brake applied, and ignition key in ON position with engine not running. When all conditions have been met, click Continue to proceed with programming.

1	 > 10 V	12.7 V	
2	  		
3	  = 0 rpm	 0 rpm	

---

**1700-08-03-39 Program control unit - Update software**

---

Automatically checked conditions

- 1 Battery voltage above 10 V
- 2 Parking brake applied
- 3 Ignition key in **ON** position. Engine not running

W2115481

13 Select "I accept" to agree to the terms and press continue to proceed.

**Note:** In the United States and Canada, the programing is NOT chargeable. An invoice will not be generated.

**1700-08-03-39 Program control unit - Update software**

---

The following control units will be programmed

**Engine Control Module (EMS)**

Chargeable programming

The software you are about to program is chargeable. If programming is performed using the software, an invoice will be generated.

Programming will be charged once even if multiple retries are needed.

The software has commercial part number

**85136079** : Engine Control Module

The number can be used for price lookup in your local system and will be specified on the invoice.

I accept 

Select I accept to agree to the terms Press Continue to proceed

W2115482

- 14 When programming is complete, click Exit to return to Main Menu to program the ACM.
- 15 When all programming is complete, clear any diagnostic trouble codes (DTC) and Finish Work.
- 16 Remove the wheel chocks.

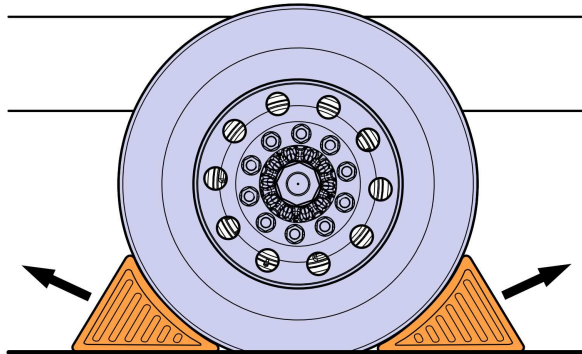

W7086759

**Reimbursement**

<p><b>This repair may be eligible for reimbursement if a product failure was experienced within time and mileage limits of the applicable Warranty coverage. Reimbursement is obtained via the normal claim handling process.</b></p>	<p><b>UCHP Reimbursement</b></p>
<p><b>Claim Type (used only when uploading from the Dealer Bus. Sys.)</b></p>	<p>W</p>
<p><b>Labor Code</b></p>	<p style="background-color: #cccccc;"></p>
<p>Primary Labor Code (Engine Control Module (ECM) and Aftertreatment Control Module (ACM), Reprogramming)</p>	<p>2841-22-09-19              0.4 hrs.</p>
<p><b>Causal Part</b></p>	<p>3092091</p>

VOLVO Trucks North America reserves the right to make any changes in design or to make additions to or upon its products without incurring any obligations to install the same on vehicles previously built.