



Special Tools Bulletin

TITLE:

Newsletter 73: Mandatory Tools

NO: 219	ISSUE DATE: 2017-02-23	CAR MARKET: United States and Canada	Page 1 of 4
	STATUS DATE: 2017-02-23		

“Right first time in Time”

Bosch Automotive Service Solutions
28635 Mound Road
Warren, MI 48092
Visit volvodealersolutions.com
Call 1-800-345-3399

All tools have been classified as required, and will be allocated to all U.S. and Canadian Volvo retailers by Bosch Corporation. U.S. retailers will be billed by Volvo Cars of North America, LLC.

Overview of contents:

Kit Number 33300297

<u>Art No.</u>	<u>Description</u>	<u>Standard</u>
9997622	Puller	C1
33300048	Clip Tool	C1
33300050	VOE Adapter Updating Kit	C1
9513096	Test Adapter version B	C1-Electric
9513097	Test Adapter version B	C1-Electric
9997569	Claw	C2
9513106	Connector Kit	C2-Electric
9997618	Vacuum Tool Kit	C2-Electric

Service Personnel: Read and initial	SERVICE MANAGER	PARTS MANAGER	WORKSHOP FOREMAN	SERVICE TECHNICIANS									



9997622 Puller

Used for mounting the steering joint. Working together with Hydraulic Pump 9512566 and Hydraulic Cylinder 9512923.

Tool standard	C1
Tool group	64
Tool bulletin	395
Model	XC90 (13-16), XC90 (16-), S90 (17-), S90L (17-) V90 (17-)
Tool board	64

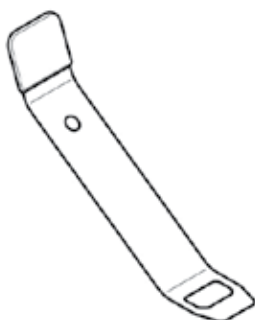

33300048 Clip Tool

Replaces Clip Tool 9997620. Used to release the clip during disassembly of the outer waist seals.

Tool standard	C1
Tool group	83.0
Tool bulletin	393
Model	XC90 (16-), S90 (17-), V90 (17-)
Tool board	80

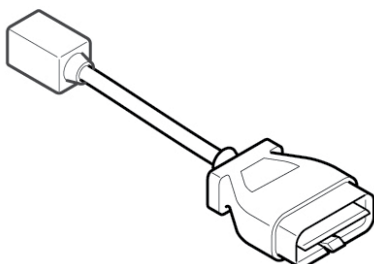

33300050 VOE Adapter Updating Kit

Replaces VOE Adapter 9513062. Consists of 2 pcs 9513108 VOE Adapter.

Adapter for onboard diagnostics and vehicle readout (OBD).

Tool standard	C1
Tool group	39
Tool bulletin	396
Model	XC90, S90, V90
Tool board	39

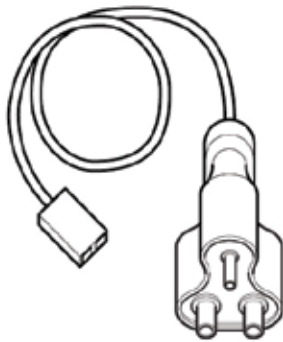

9513096 Test Adapter, Version: B

Used when Isolation testing the high voltage system. Used together with Isolation Tester 9513038. UL approved US plug. (Only for US/JP.)

Tool standard	C1-Electric
Tool group	39
Tool bulletin	396
Model	XC90 Hybrid
Tool board	Service table

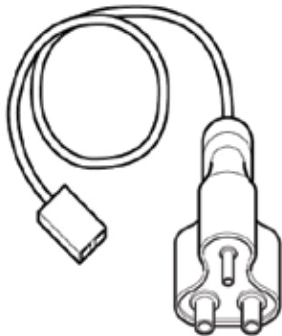

9513097 Test Adapter, Version: B

Used when resistance testing the high voltage system. Used together with Isolation Tester 9513038. UL approved US plug. (Only for US/JP.)

Tool standard	C1-Electric
Tool group	39
Tool bulletin	396
Model	XC90 Hybrid
Tool board	Service table

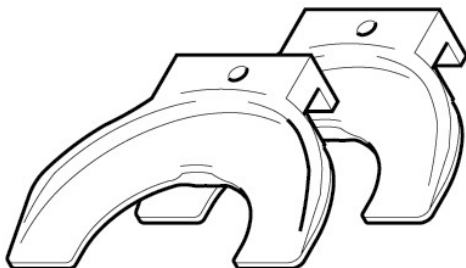

9997569 Claw

Used for removal and installation of springs. Working with Hydraulic Pump 9512566 and Hydraulic Compressor 9512911.

Tool standard	C2
Tool group	76
Tool bulletin	395
Model	XC60 (17-), XC90 (16-), S90 (17-), S90L (17-), V90 (17-), V90CC (17-)
Tool board	70

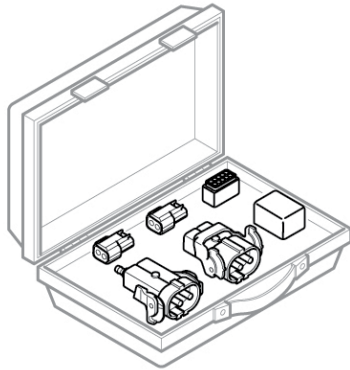

9513106 Connector Kit

Sealing Contacts for control of density in the high-voltage battery casing. Used with Vacuum Tool Kit 9997618.

Tool standard	C2-Electric
Tool group	39
Tool bulletin	396
Model	XC90 Hybrid
Tool board	39

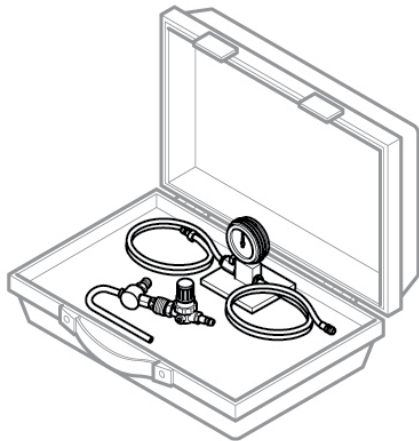

9997618 Vacuum Tool Kit

Used at density testing of high-voltage battery. Working together with Contact Kit 9513106.

Tool standard	C2-Electric
Tool group	31
Tool bulletin	395
Model	XC90 Hybrid
Tool board	30