



Audi

Emissions Recall

Code: 23V5

REVISION

Subject	3.0L TDI Engine – Emissions System Modification – Customer Only (Retail Sold) TDI Vehicles <u>USA ONLY</u>
Release Date	November 16, 2017
Revision Summary	Updated work procedure and added link to repair video.
Affected Vehicles	<p>U.S.A.: 2013-2015 MY Audi Q7 3.0L TDI Generation 2.1</p> <p><i>Check Campaigns/Actions screen in Elsa on the day of repair to verify that a VIN qualifies for repair under this action. Elsa is the <u>only</u> valid campaign inquiry & verification source.</i></p> <ul style="list-style-type: none"> ✓ Campaign status must show “open.” ✓ If Elsa shows other open action(s), inform your customer so that the work can also be completed at the same time the vehicle is in the workshop for this campaign.
Problem Description	3.0L TDI vehicles were equipped with undisclosed Auxiliary Emission Control Devices which are not permitted by emissions regulations.
Corrective Action	Install updated engine control module (ECM) software, transmission control module (TCM) software and hardware to bring affected vehicles into regulatory compliance.
Code Visibility	On or about November 6, 2017, affected vehicles were listed on the Inventory Vehicle Open Campaign Action report under My Dealership Reports. A list was not posted for dealers who did not have any affected vehicles. The campaign code showed open on affected vehicles in Elsa and affected vehicles are identified with this campaign code in the VIN Lookup tool at www.audiusa.com .
Owner Notification	Owner notification took place on November 6, 2017.
Emissions Campaigns Requirements (CALIFORNIA ONLY)	The California Air Resources Board and the Department of Motor Vehicles (DMV) require emissions-related campaigns to be completed prior to vehicle registration renewal. When campaign work is done you must provide the owner with a signed “Vehicle Emission Recall – Proof of Correction” certificate (RC EMISCAVWAW). Order certificates online via the Compliance Label Ordering portal at www.accessaudi.com .
Loaner/Rental Vehicle – REQUIRED!	<p>Customers are eligible to receive a loaner vehicle. Please refer to the warranty extension bulletin AWA 17-13 for claiming instructions.</p> <p>To remain compliant with the Settlement Agreement, Service Consultants <i>must</i> complete a Loaner/Rental label and it <i>must</i> be signed by the customer. This documents each customer’s decision to accept or decline the offer for a loaner or rental vehicle while the Approved Emissions Modification was being performed on their vehicle.</p>

I hereby acknowledge that I was offered a Loaner or Rental vehicle to use while the TDI Emissions Recall is performed on my vehicle.
I elected
to: Accept Decline 

Customer Name (Print):
Customer
Signature:
Date:

Affix the completed label to the Repair Order and follow the new photo documentation requirements for this label in the IN-FORM tool.

Additional Information

Please alert everyone in your dealership about this action, including Sales, Service, Parts and Accounting personnel. Contact Warranty if you have any questions.

Fill out and affix the appropriate TDI Recall Proof of Completion label and the appropriate Supplemental Vehicle Emissions Control Information Label after work is complete. ***Additional shipments will be released based on the volume of completed repairs claimed through SAGA. The parts will not be available for order through the website at this time.***

Claim Entry Instructions

After campaign has been completed, enter claim as soon as possible to help prevent work from being duplicated elsewhere. Attach the Elsa screen print showing action open on the day of repair to the repair order.

If customer refused campaign work:

- ✓ U.S. dealers: Submit the request through Audi Warranty Online under the Campaigns/Update option.

Service Number	23V5
Damage Code	0099
Parts Vendor Code	002
Claim Type	Sold vehicle: 7 10
Causal Indicator	Mark 3.0L Gen 2.1 Kit as causal*
Vehicle Wash/Loaner	Do not claim vehicle wash/loaner under this action
Criteria I.D.	01

MY 2013/2014:
 Install 3.0L Gen 2.1 Kit, install Glow Plug with Combustion Chamber Pressure Sensor, Top off AdBlue tank, and *install a supplemental Vehicle Emissions Control Information label and TDI Emissions Modification Proof of Completion Label.

Labor operation: 2674 19 99 155 T.U.

Quantity	Part Number	Description
1.00	4L0298099 X	3.0L Gen 2.1 Kit*
1.00	059905061H	Glow Plug with Combustion Chamber Pressure Sensor
Up to 14.00	G 052910A2	AdBlue (one bottle = 0.5 gallon/ 1.89 Liter)

--AND--

Connect battery charger.

Labor operation: 2706 89 50 10 T.U.

--AND--

Connect vehicle diagnostic tester, perform software update for control unit.

Labor operation: 2360 22 99 Time stated on diagnostic protocol (Maximum 60 T.U.)

--AND--

Follow IN-FORM tool app.

Labor operation: 0183 00 99 20 T.U.

***Labels are sent free of charge. They cannot be charged to this campaign.**

Continue to next page

Criteria I.D.	02									
	<p>MY 2015: Install 3.0L Gen 2.1 Kit, top off AdBlue tank, and *install a supplemental Vehicle Emissions Control Information label and TDI Emissions Modification Label.</p> <p>Labor operation: 2674 20 99 135 T.U.</p> <table border="1"> <thead> <tr> <th>Quantity</th> <th>Part Number</th> <th>Description</th> </tr> </thead> <tbody> <tr> <td>1.00</td> <td>4L0298099 X</td> <td>3.0L Gen 2.1 Kit</td> </tr> <tr> <td>Up to 14.00</td> <td>G 052910A2</td> <td>AdBlue (one bottle = 0.5 gallon/ 1.89 Liter)</td> </tr> </tbody> </table> <p>--AND-- Connect battery charger. Labor operation: 2706 89 50 10 T.U.</p> <p>--AND-- Connect vehicle diagnostic tester, perform software update for control unit. Labor operation: 2360 22 99 Time stated on diagnostic protocol (Maximum 60 T.U.)</p> <p>--AND-- Follow IN-FORM tool app. Labor operation: 0183 00 99 20 T.U.</p> <p><i>*Labels are sent free of charge. They cannot be charged to this campaign.</i></p>	Quantity	Part Number	Description	1.00	4L0298099 X	3.0L Gen 2.1 Kit	Up to 14.00	G 052910A2	AdBlue (one bottle = 0.5 gallon/ 1.89 Liter)
Quantity	Part Number	Description								
1.00	4L0298099 X	3.0L Gen 2.1 Kit								
Up to 14.00	G 052910A2	AdBlue (one bottle = 0.5 gallon/ 1.89 Liter)								

At this time, affected new and used vehicles in dealer inventory are not included in this emissions modification release.

NOTE
 Damages resulting from improper repair or failure to follow these work instructions are the dealer's responsibility and are not eligible for reimbursement under this action.

Required Parts

Criteria	Quantity	Part Description	Part Number
01, 02	1	3.0L Gen 2.1 Kit	4L0298099 X
01	1	Glow Plug with Combustion Chamber Pressure Sensor	059905061H
01, 02	up to 23.0L	AdBlue	G 052910A2

Required Labels





Quantity	Part Description	Part Number	Vehicle
1	TDI Proof of Completion Label	4L0 010 023 B	MY 2013 and 2014 Q7
--OR--			
1	TDI Proof of Completion Label	4L0 010 023 A	MY 2015 Q7
--AND--			
1	VECI Label	059 010 533 BH	MY 2013 Q7
--OR--			
1	VECI Label	059 010 533 BJ	MY 2014 Q7
--OR--			
1	VECI Label	059 010 533 BK	MY 2015 Q7

IMPORTANT!
Maintaining Your TDI Campaign Label Supply

- SAGA claims count! Warranty Administrators should enter TDI claims promptly to ensure labels can be allocated to support future repairs.**
- TDI Labels are allocated daily, free of charge, based on the count of TDI claims entered in SAGA.**
- TDI labels cannot be ordered through the Compliance Label Ordering Portal. If you have questions, please email labelrequest@audi.com.**

The repair information in this document is intended for use only by skilled technicians who have the proper tools, equipment and training to correctly and safely maintain your vehicle. These procedures are not intended to be attempted by "do-it-yourselfers," and you should not assume this document applies to your vehicle, or that your vehicle has the condition described. To determine whether this information applies, contact an authorized Volkswagen dealer. ©2017 Audi of America, Inc. All Rights Reserved.

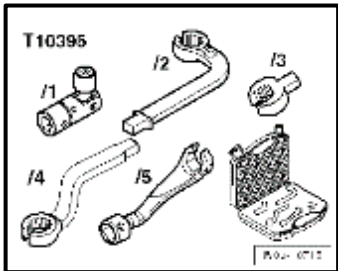
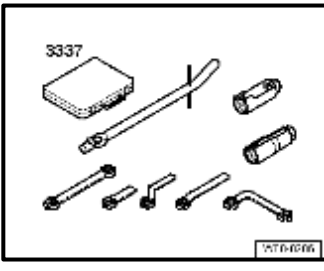
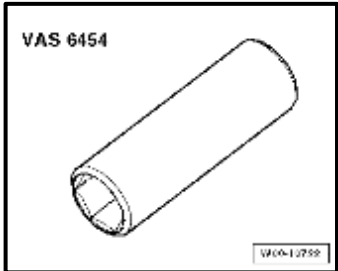
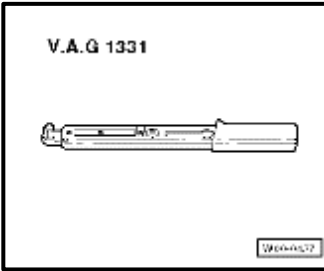
Required Tools

 <p>VAS 6154</p>	<p>VAS6150D - Diagnostic Tester (or equivalent) VAS6154 - Vehicle Communication Interface (or equivalent)</p>		<p>GRX3000VAS – Battery Tester/Charger (or equivalent)</p>
 <p>T10395</p>	<p>Diesel Engine Tool Set - 17mm -T10395A- (or equivalent)</p>	 <p>3337</p>	<p>Ring Wrench 7-Piece Set -3337- (or equivalent)</p>
 <p>VAS 6454</p>	<p>Glow Plug Socket – VAS6454 (or equivalent)</p>	 <p>V.A.G 1331</p>	<p>Torque Wrench 1331 5-50Nm -VAG 1331 (or equivalent)</p>
 <p>V.A.G 1332</p>	<p>Torque Wrench 1332 40-200Nm -VAG 1332 (or equivalent)</p>	 <p>VAS 6122</p>	<p>Engine Bung Set -VAS6122- (or equivalent)</p>



- Service Modification Validation Web App
- tdi-inform.track360.com

TIP

This web application is compatible with desktops, laptops, Apple and Android mobile devices running the most current versions of FireFox, Chrome, Safari, or Explorer as well as iOS 9+ on iPads and iPhones.

NOTE

RISK of Non-payment!

Not using the IN-FORM tool to document and validate the modification will stop the processing of payment for your dealership even if the modification has been completed. Look for the image below to indicate labor operations, parts, or labeling that requires IN-FORM tool image documentation.



Emissions Modification Instruction

Section A - Check for Previous Repair

Applicable criteria ID(s)	Campaign/Action Status
01 ← 2	Open ← 1

EXAMPLE

- Enter the VIN in Elsa and proceed to the "Campaign/Action" screen.

TIP

On the date of repair, print this screen and keep a copy with the repair order.

- Confirm the Campaign/Action is open <arrow 1>. If the status is closed, no further work is required.
- Note the Applicable Criteria ID <arrow 2> for use in determining the correct work to be done and corresponding parts associated.
- Check for other Open campaign actions <arrow>.
- Other Open campaign actions must be completed prior to releasing the vehicle to the customer.

Vehicle data
VIN: 3VW1T1AJ3R0004800

Serial Number	Campaign/Action	Start	Designation	Repair date	Criteria	Completion/Action Status
1	2332	2012-07-19	S-SERV_ACT - Diesel Fuel Only Information	2012-07-21	02	Closed
2	2339	2011-10-04	A-REGALL - Diesel Fuel Injection Lines		01, 02	Open
3	2306	2015-04-07	S-SERV_ACT - ECU Software Update		01	Open

Example

Proceed to Section B

The repair information in this document is intended for use only by skilled technicians who have the proper tools, equipment and training to correctly and safely maintain your vehicle. These procedures are not intended to be attempted by "do-it-yourselfers," and you should not assume this document applies to your vehicle, or that your vehicle has the condition described. To determine whether this information applies, contact an authorized Volkswagen dealer. ©2017 Audi of America, Inc. All Rights Reserved.

Section B – Check for Service Initiation

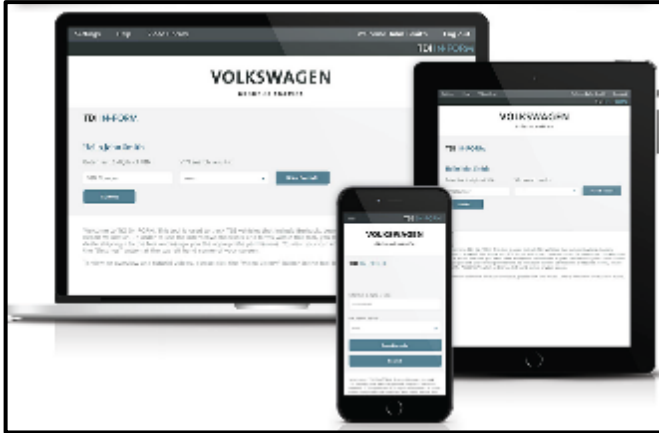

NOTE

RISK of Non-payment!

Not using the IN-FORM tool to document and validate the modification will stop the processing of payment for your dealership even if the modification has been completed. Look for the image below to indicate labor operations, parts, or labeling that requires IN-FORM tool image documentation.



NOTE

RISK of Non-payment!

Ensure that the “check mark” <arrow> is present prior to beginning any repair.

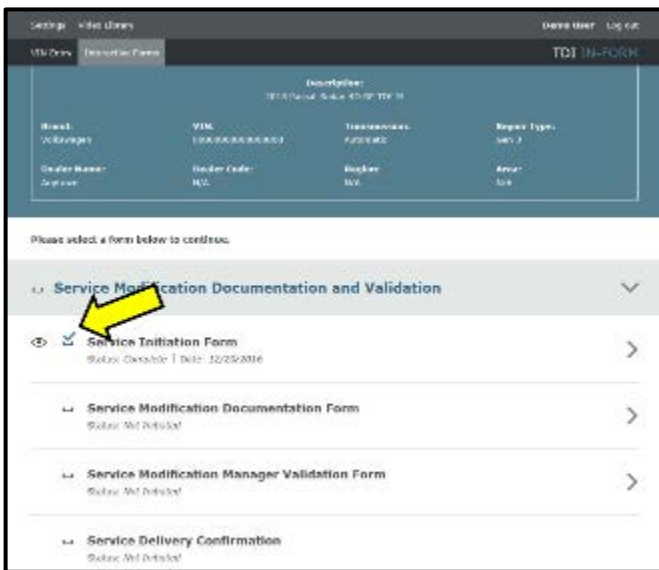

- Check the Service Initiation Form for the presence of the “check mark” <arrow>.
 - If “check mark” <arrow> is NOT present, DO NOT proceed with any repair.
 - If “check mark” <arrow> is present, initiate Service Modification Documentation Form and continue work.

DO NOT proceed with any work unless you can initiate the Service Modification Documentation Form.

Proceed to Section C

Section C – Check for Pre-existing MIL ON conditions and Vehicle Modifications

- Perform a visual inspection of the intake, exhaust, and emissions systems.
 - If the visual inspection of the intake, exhaust, or emissions equipment reveals damage or concerns, **STOP**, create an ATA ticket and contact the Audi Technical Assistance.
 - If the visual inspection of the intake, exhaust, or emissions equipment reveals no damage or concerns, continue the work procedure.
- Check for vehicle modifications from original equipment.
 - If vehicle modifications from original equipment related to emissions components are found, **STOP**, create an ATA ticket and contact the Audi Technical Assistance.
 - If vehicle modifications from original equipment related to emissions components are not found, continue the work procedure.
- Check for illumination of the MIL <arrow>.
 - If MIL is illuminated, **STOP**, create an ATA ticket and contact the Audi Technical Assistance.
 - If MIL is not illuminated, continue the work procedure.



i TIP

ATA cases regarding MIL ON conditions require a GFF diagnostic log to be uploaded at the time of first contact.

! NOTE

RISK of Non-payment!

The purpose for this step is to document vehicle condition prior to initiation of this action and does not authorize the repair of any pre-existing conditions.

Proceed to Section D

Section D – Install Hardware

⚠ WARNING

Risk of injury. Refer to “Warning and Safety Precautions”, found in **Appendix A** at the end of this document.

! NOTE

- If the vehicle is equipped with air suspension, vehicle lift mode must be activated before raising vehicle with vehicle jack or hoist so that the air suspension automatic control procedures do not create difficulties.
- Vehicle lift mode is automatically switched off at a speed above 6 mph.



- Fill the AdBlue tank to maximum fill line.
 - AdBlue filler is located behind the fuel door.

Part Number	Description	Quantity
G 052 910 A2	AdBlue	Up to 23.0L



If equipped with air suspension:

- Turn on the ignition.
- Press “CAR” function button <A>. “adaptive air suspension” main menu appears.
- Press “SETUP” function button. “adaptive air suspension” menu appears.
- Rotate control knob to “Vehicle Lifting Mode” and select “ON”.
- Raise the vehicle on hoist to desired level.

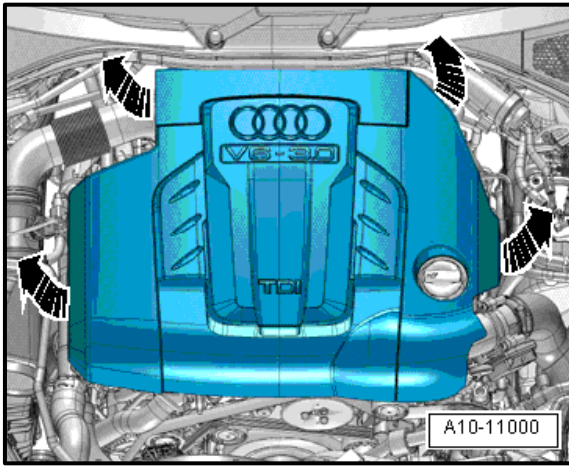

For Criteria 01 ONLY: Install Glow Plug with Combustion Chamber Pressure Sensor (MY 2013-2014)

- Carefully remove the engine cover from the 4 bolts <arrows> one after the other. Do not remove the engine cover on one side or in a jerking manner.

- Disconnect the glow plug connector <1> from Cylinder 2 Glow Plug with Combustion Chamber Pressure Sensor -G678- <2>.
- Clean the glow plug duct in the cylinder head (contaminants must not fall into the cylinder).

NOTE

Examples for cleaning:

- Extract large contaminants with a vacuum cleaner.
- Spray a brake cleaner or another suitable cleaner into the glow plug shaft, let it work and then use compressed air to remove it.
- Then clean the glow plug duct with a rag dampened with oil.

- Loosen the Cylinder 2 Glow Plug with Combustion Chamber Pressure Sensor -G678- <2> using Glow Plug Socket - VAS6454.
- Carefully remove the Cylinder 2 Glow Plug with Combustion Chamber Pressure Sensor -G678- by hand or with a hose without bending it.
- Carefully install the new the Cylinder 2 Glow Plug with Combustion Chamber Pressure Sensor -G678- <2> by hand or with a hose without bending it.

Part Number	Description	Quantity
059 905 061 H	Glow Plug with Combustion Chamber Pressure Sensor	1

- Using Glow Plug Socket - VAS6454, tighten to 12 Nm.
- Reconnect the glow plug connector <1> from Cylinder 2 Glow Plug with Combustion Chamber Pressure Sensor -G678- <2> and make sure it is secure.

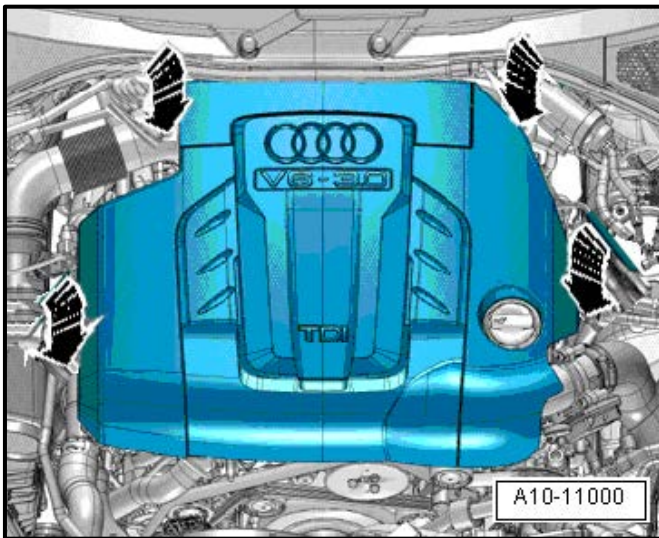

NOTE

- In order to prevent damage, do not hit the engine cover with your fist or tool.
 - Be sure not to place the engine cover on the oil filler tube.
-
- Reinstall the engine cover by first pushing the cover with both hands into the rubber grommets in the rear and then into the rubber grommets in the front.

All models, continue to the next step.

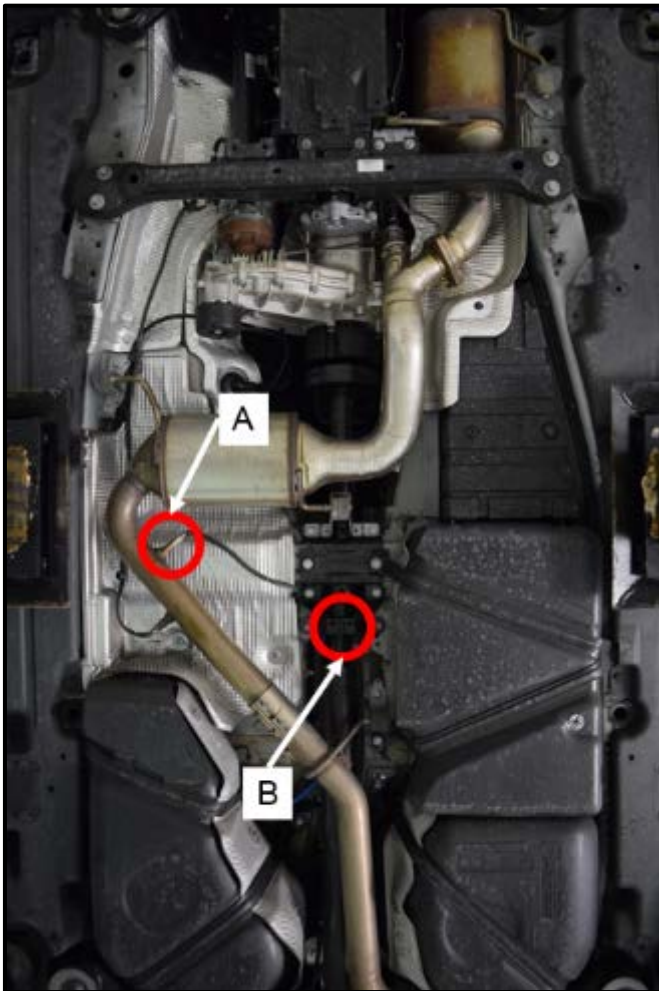
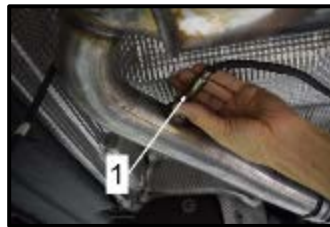

Figure <A>

Remove the NOx #2 sensor <1> from the catalyst pipe.



Figure

Cover the NOx #2 Sensor with a plastic bag (or equivalent) and secure it out of the way with a tie strap (or equivalent) attached through either one of two holes in the rear driveshaft mid-bearing bracket .



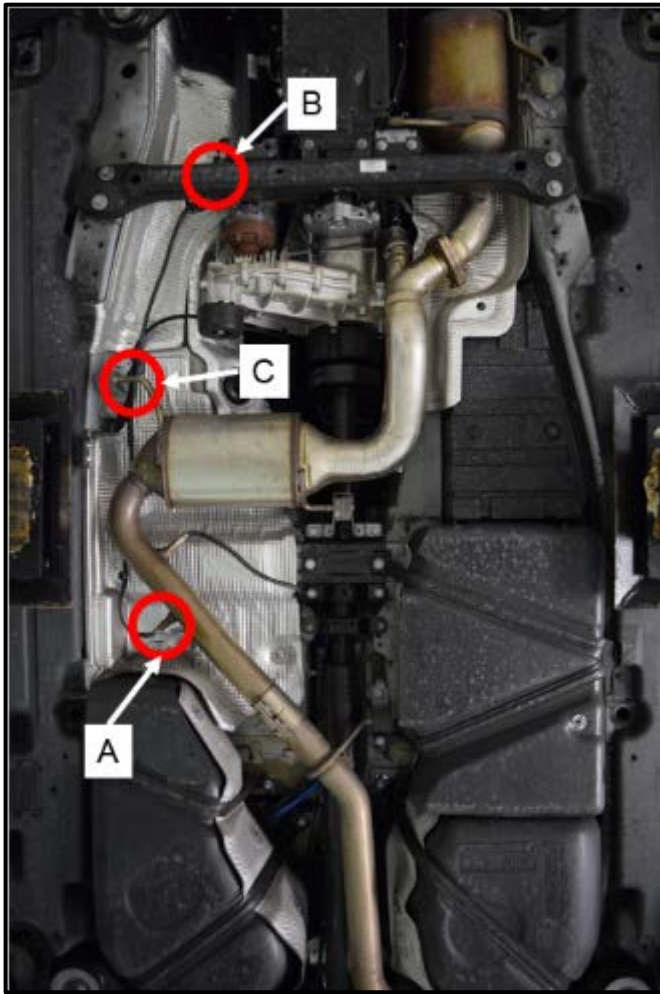

Figure <A>

Remove the PM Sensor <1> from the SCR Catalyst pipe.



Figure

Disconnect the electrical connection at the PM Sensor Module <2>.

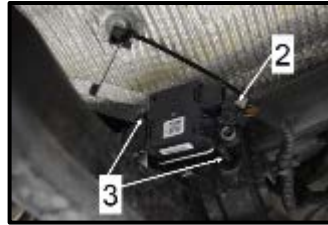

Remove the two nuts <3> securing the PM Sensor Module to the bracket.

Figure <C>

Remove the PM Sensor wiring harness from the securing clips and tie straps, and then remove the sensor, module, and harness from the vehicle as an assembly. Route the wiring harness up and over the exhaust bracket <C>.



- Loosen the screw <A> and remove the clamp from the Reducing Agent Injector -N474-.
- Leave the electrical connector and the Reducing Agent Injector AdBlue feed line connected at this time. This will reduce the possibility of contaminating the electrical connection with AdBlue.
- Secure the Reducing Agent Injector out of the way with a tie strap (or equivalent).

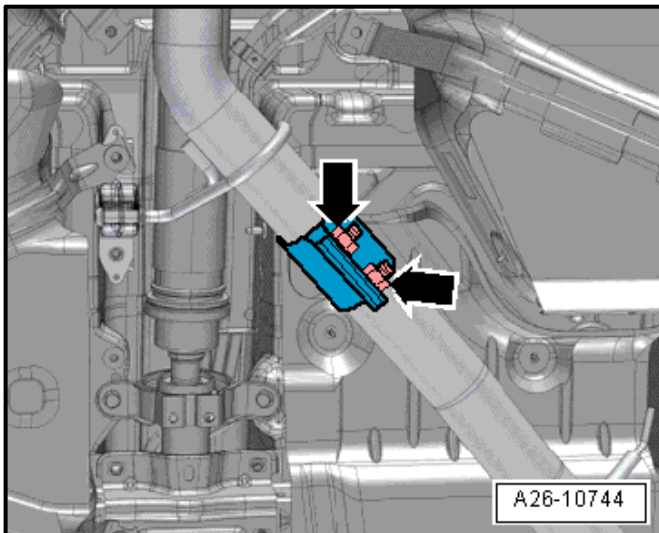

- Loosen the two nuts on the Dual Clamp <arrows> so the clamp can slide back and forth on the exhaust pipe.
- Leave the clamp in the installed position at this time. This will assist in holding the SCR Catalyst in place while removing the brackets in the next step.

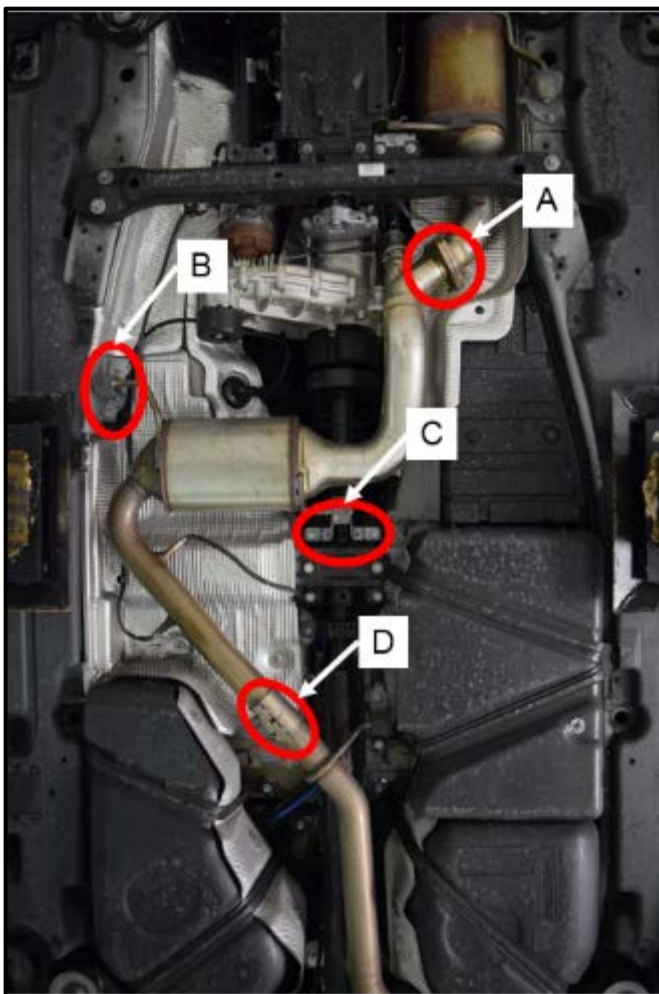

- With the assistance of a second technician, remove the three nuts <A> from the exhaust studs securing the SCR Catalyst to the Diesel Particulate Filter (DPF).
- Remove the bolts from SCR Catalyst brackets at locations <B and C> with assistance from second technician to support the SCR Catalyst while the brackets are removed.
- Slide the Dual Clamp <D> towards the rear of the vehicle, and with the assistance of a second technician, remove the SCR Catalyst from the vehicle.
- Remove the Dual Clamp <D> from the exhaust pipe and discard.

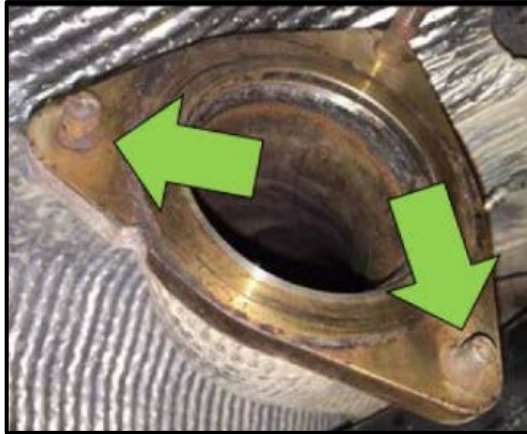

OTC 5057 Clevis Pin Press



Scan this QR Code or copy/paste the link below into your internet browser to see a short video explaining this procedure:

<https://audi-external.kzoplatform.com:443/swf/player/356>



NOTE



Due to corrosion, one or more of the mounting studs may break <arrows> when removing the SCR catalytic converter from the Diesel Particulate Filter (DPF) flange.

DO NOT use a hammer and punch, heat, torch, air hammer, or other method to remove the studs from the DPF flange.

Consequential damage to Exhaust Gas Temperature Sensors, Diesel Particulate Filter, AdBlue Injector Feed Line, or any other ancillary components **WILL NOT BE COVERED** under this action due to damage from heat, impact, or vibration.

- If stud replacement is necessary, **IT IS REQUIRED** to use a press tool such as the OTC 5057 clevis pin press (or equivalent), or other available screw or hydraulic type clevis/stud press tool to remove all necessary studs from the rear DPF flange.
 - It is advised if one stud breaks that all three studs are pressed out and replaced with the bolts/nuts included in the parts kit.
 - Lubricate the OTC 5057 clevis/stud press tool threads and the press pin contact tip with hot bolt paste or anti-sieze lubricant before each use.
 - For best results, cut any studs that do not break off as close to the flange as possible. Pressing a full length stud increases the chance of bending the stud, which may complicate the removal process.
 - Use a cap from the VAS 6122 Engine Bung Set (or equivalent) to cover the hole in the DPF to eliminate the chance of contaminating of the DPF substrate with metallic particles when cutting the studs.
- Install the replacement bolts and corresponding nuts into the rear DPF flange.

Part Number	Description	Quantity
N 01024713	Replacement Exhaust Bolt	3
N 91130802	Shouldered Hex Nut	3

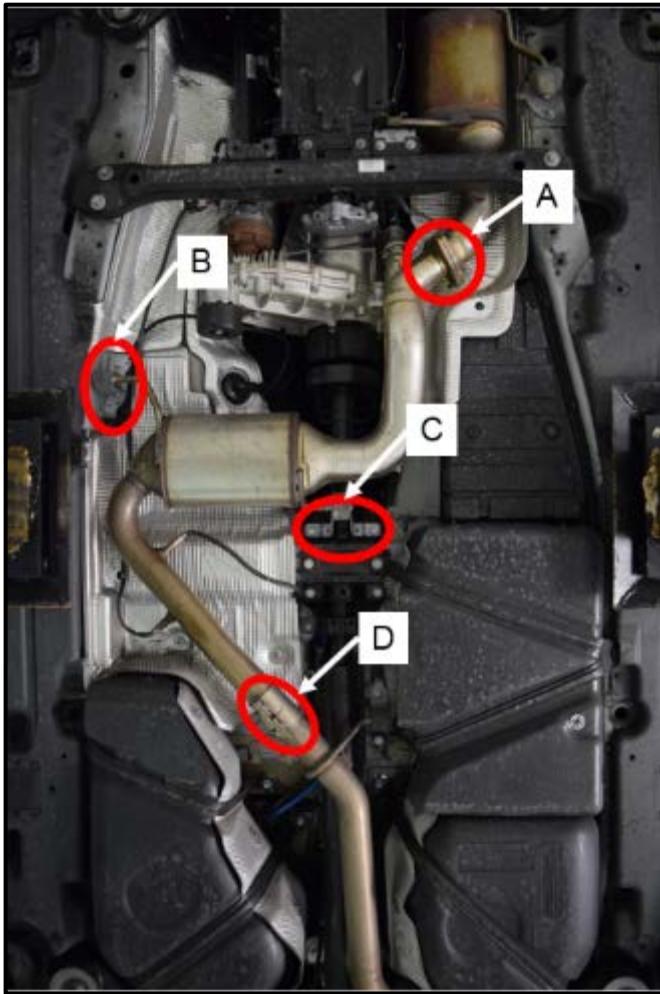

NOTE

Coat the threads on the nuts and exhaust studs/bolts <A> with hot bolt paste prior to installation. Refer to the Parts Catalog.

- Install the new exhaust Dual Clamp onto the exhaust pipe at location <D> and slide the clamp to the rear of the vehicle, but do not tighten.
- With the assistance of a second technician, install the new SCR Catalyst with a new gasket between the SCR Catalyst and DPF <A>. Fit the SCR Catalyst onto the DPF flange studs/bolts and install new nuts and tighten to 23 Nm.
- Slide the Dual Clamp into the installed position on the SCR Catalyst, but do not tighten. This will assist in holding the SCR Catalyst in place while the exhaust system is properly tensioned.
- Install the bolts for the SCR Catalyst brackets <B and C> and tighten by hand.

Part Number	Description	Quantity
7P0 254 400 BX	Exhaust Pipe With Catalyst And Adapters	1
1K0 253 141 J	Dual Clamp	1
7L5 253 115 C	Gasket	1
N 911 308 02	Shouldered Hex Nut	3

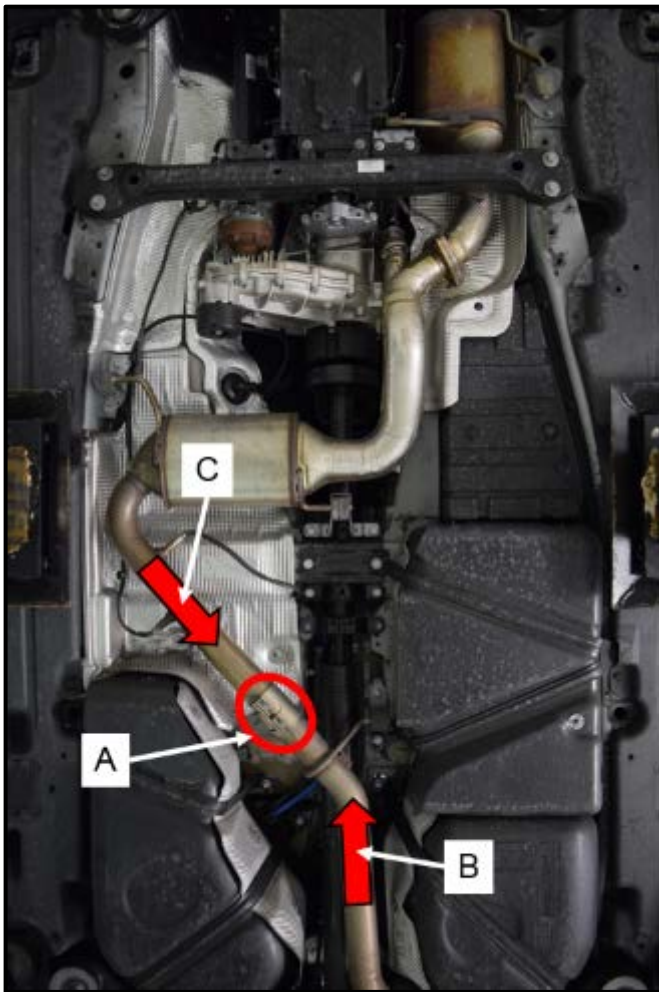

- Tighten the Dual Clamp <A> until there is a slight dragging resistance on both the SCR Catalyst pipe <arrow C> and the rear resonator/muffler pipe <arrow B>, but do not tighten so much that the pipes cannot slide in and out of the Dual Clamp <A>.
- Pretension the rear resonator/muffler hanging straps by pulling the rear resonator/muffler pipe towards the front of the vehicle <arrow B> and pulling the SCR Catalyst pipe towards the rear of the vehicle <arrow C>.

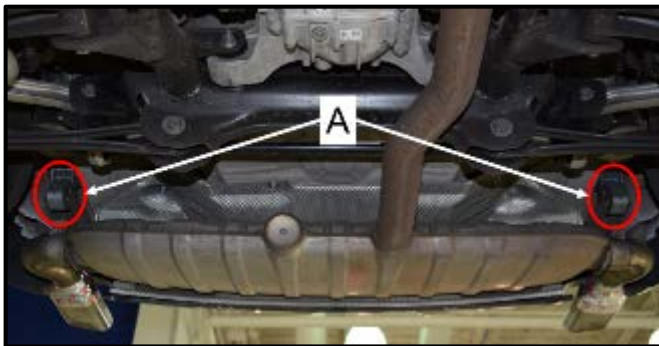

<A> = Rear Resonator Hanging Straps

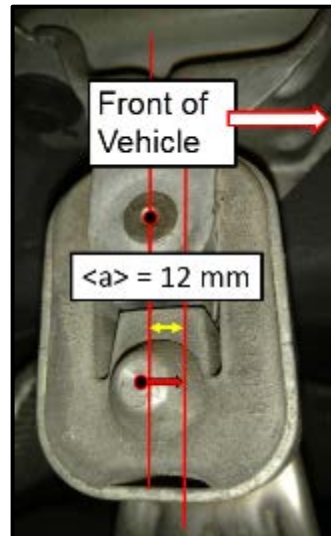

In order to reduce harmonic vibration, the rear muffler/resonator straps <A> require 12 mm of forward tension, as shown in the sub-photo. Pull forward on the rear muffler/resonator pipe and insert the pipe deeper into the Dual Clamp until this dimension is achieved.

- Once the desired dimension of <a> = 12 mm is achieved, tighten the Dual Clamp nuts to 23 Nm.

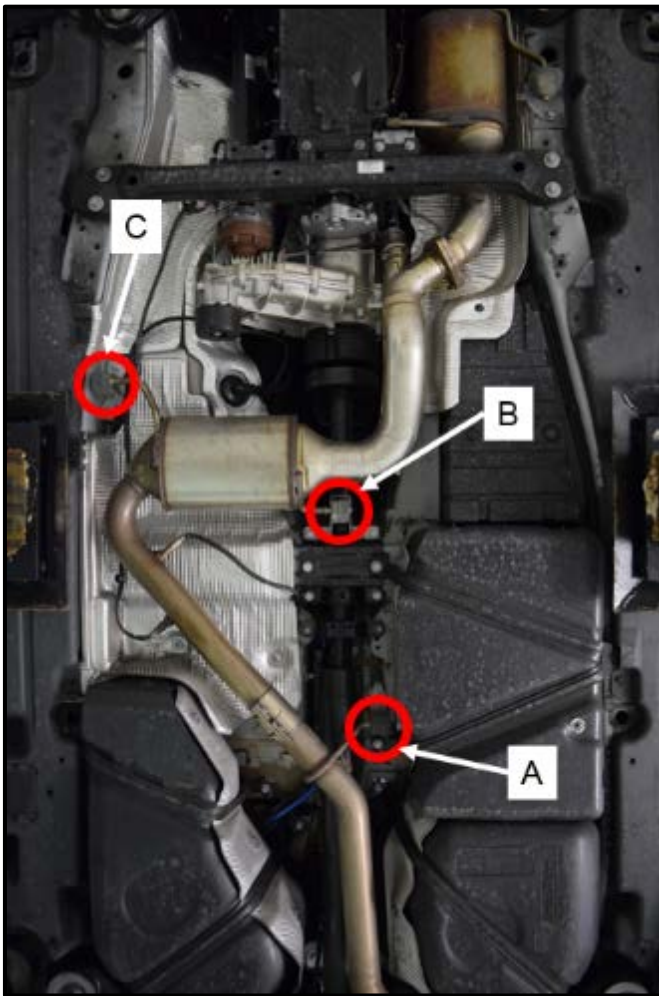
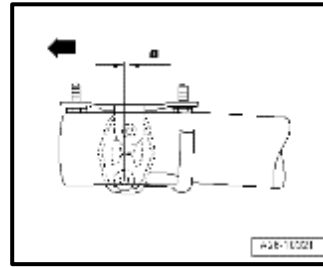

Figure <A>



Front Muffler/Resonator hanging strap: $\langle a \rangle = 4 \text{ mm}$

If necessary, loosen the bolts at the forward resonator pipe hanging strap <A> and adjust the bracket until $\langle a \rangle = 4 \text{ mm}$ of forward tension.

- Tighten the two hanging strap bolts to 23 Nm.

Figures <B and C>



Left and Right SCR hanging straps: $\langle a \rangle = 0.00 \text{ mm}$, install without tension.

If necessary, loosen the bolts at the left and right SCR Cat hanging straps <B and C> and adjust the brackets until $\langle a \rangle = 0.00 \text{ mm}$. The SCR Catalyst hanging straps are installed tension free.

- Tighten the two hanging strap bracket bolts to 60 Nm.
- Tighten the two hanging strap bracket bolts <C> to 23 Nm.

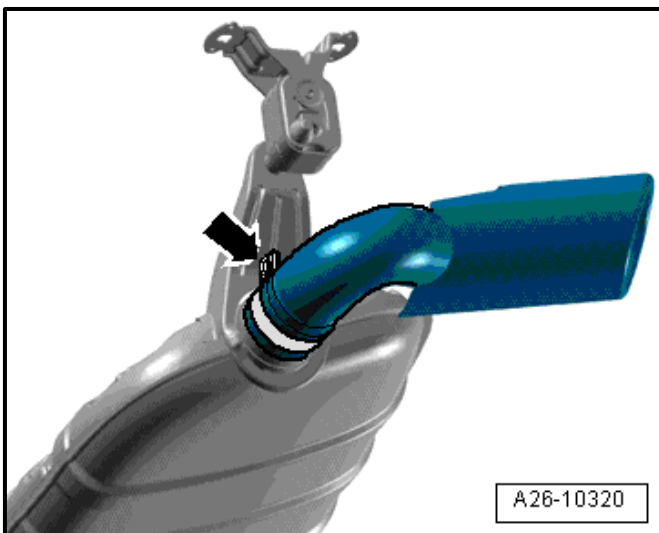

- If necessary, align the tail pipes by first loosening the screw-type clamp <arrow> on the tailpipes.

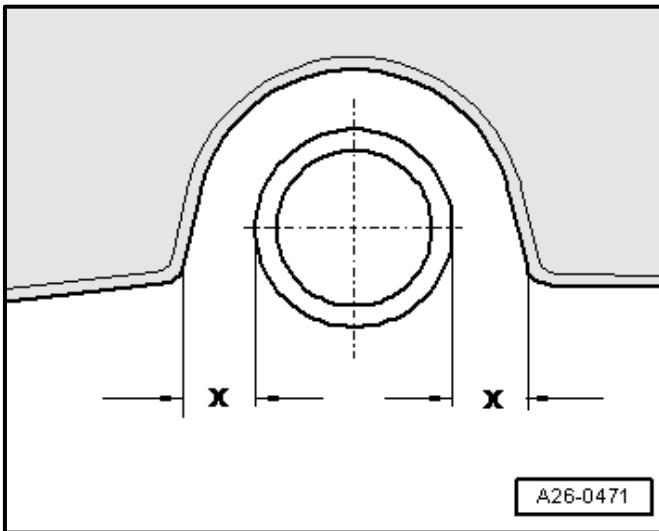

A26-0471

- Align tail pipe to the rear muffler and center the tail pipes into the bumper cover.
- Check distance of left and right tail pipes to bumper.
 - Dimension -x- left = dimension -x- right

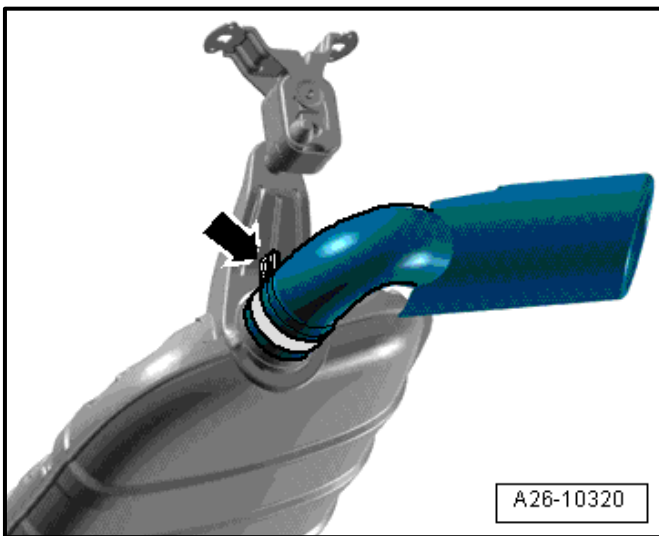

A26-10320

- Once the tail pipe is properly aligned to the bumper cover, tighten the screw-type clamps <arrow> to 60 Nm.

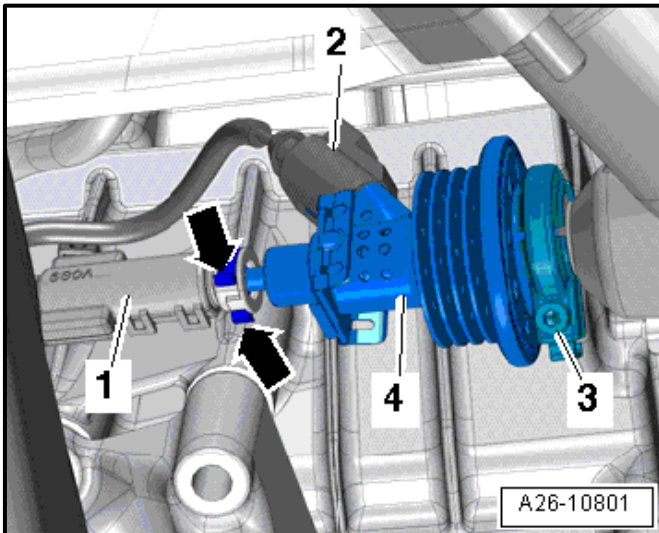

A26-10801

NOTE

- Lay a cloth below the Reducing Agent Injector to catch any escaping AdBlue reducing agent.
- Make certain the electrical connector is installed into the new Reducing Agent Injector -N474- before disconnecting the AdBlue reducing agent feed hose. This will reduce the possibility of contaminating the electrical connection with AdBlue.

Part Number	Description	Quantity
4H0 131 113 A	Injector For Reduction Agent	1

- Disconnect the electrical connector <2> from the existing Reducing Agent Injector -N474- <4>.
- Connect the connector <2> to the new Reducing Agent Injector -N474- <4> and set it aside.

- Make certain the electrical connector is installed into the new Reducing Agent Injector before disconnecting the AdBlue reducing agent feed hose. This will reduce the possibility of contaminating the electrical connection with AdBlue.
- Remove the AdBlue reducing agent feed hose <1> by pressing the release clasps <arrows> and remove the reducing agent hose <1>.
- Connect the AdBlue reducing agent hose <1> to the new Reducing Agent Injector -N474- <4>.
- Install the new Reducing Agent Injector -N474- into the SCR Catalyst pipe ensuring that the tabs on the Injector <arrows> fit into the corresponding mounts in the SCR catalytic converter.

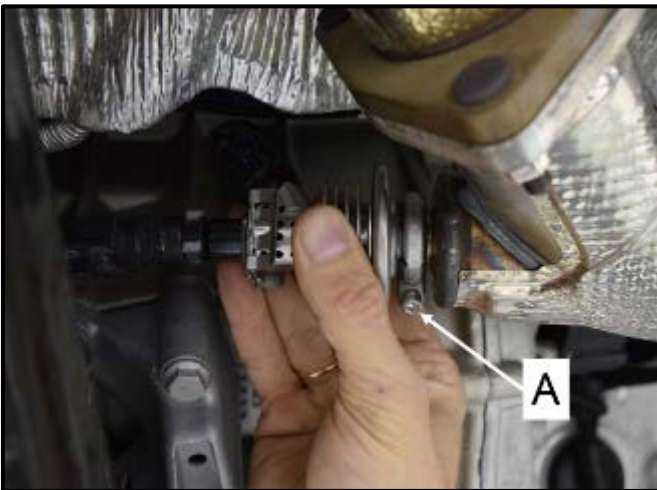

i TIP

The gasket comes pre-installed on the new Injector. Verify the new gasket is present and seated properly before installation.

- Install a new retaining clamp <A> and tighten the bolt to 5 Nm.

Part Number	Description	Quantity
3C0 253 725	Retaining Clamp	1

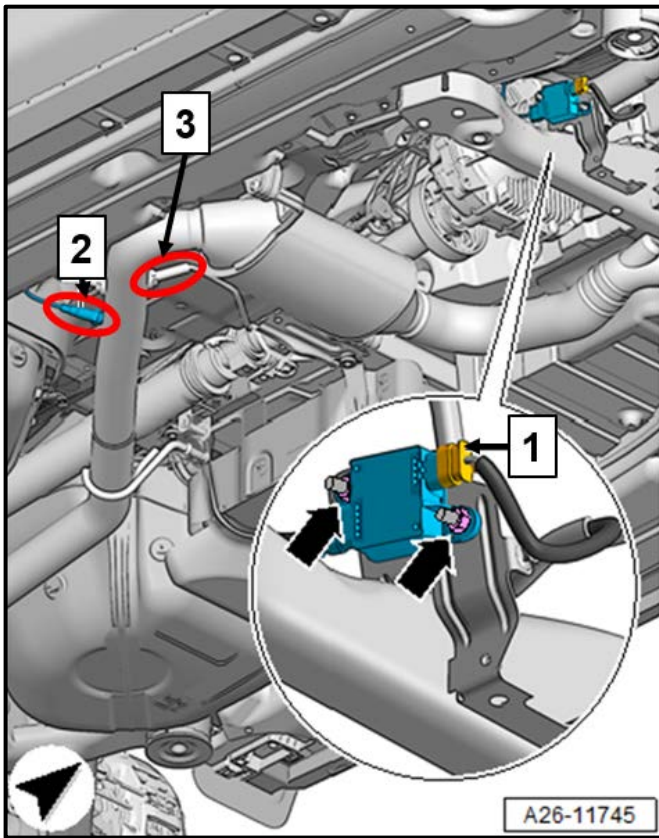

NOTE

- Coat new PM Sensor and the existing NOx #2 Sensor threads with hot bolt paste. Paste must not get on to slits of sensor body. Refer to the Parts Catalog.
- The sensor wires must always be attached at the same location as removed when installing. Do not let the sensor wires come in contact with the exhaust pipe.

- Install the new PM Sensor -G784- <2> and tighten to 50 Nm.
- Remove the plastic bag (or equivalent) from the NOx #2 sensor <3>, install and tighten to 50 Nm.

Part Number	Description	Quantity
059 906 261	PM Sensor	1

- Recover all retention clips from the removed PM Sensor and NOx #2 Sensor harnesses and install them into the appropriate locations on the chassis. A new tie strap may be required for some of the retention clips (shop supply).
- Install the PM Sensor control module -G784- and the nuts <arrows>. Tighten to 6 Nm.
- Reconnect the PM Sensor connector <1>.
- Capture a single photo showing both the new SCR Catalyst and the new PM Sensor and upload the photo to the TDI IN-FORM Tool.
- See the example photo for proper orientation and preferred photo angle. This photo can be captured in the air during the repair, or on the ground after the repair as shown.





- Switch off Vehicle Lift Mode by turning on the ignition.
- Press “CAR” function button <A>. “adaptive air suspension” main menu appears.
- Press “SETUP” function button. “adaptive air suspension” menu appears.
- Rotate control knob to “Vehicle lift mode” and select “OFF” in order to switch off vehicle lift mode.

Proceed to Section E

Section E – Software Update Procedure

NOTE

Prior to launching the VAS Diagnostic Tester and starting an update, ensure the following conditions are met;

- ✓ **The ODIS software is completely up to date.**
 - Refer to the “Alerts” section on ServiceNet home page for the current ODIS version.
- ✓ **The battery charger is connected to the vehicle battery and remains connected for the duration of the software update.**
 - Battery voltage must remain above 12.5 volts for the duration of the software update. Failure to do so may cause the update to fail, which could result in damage to the control module. Control modules damaged by insufficient voltage will not be covered.
- ✓ **The screen saver and power saving settings are off.**
 - Failure to do so may result in the tester entering power save mode during the software update, which could result in damage to the control module.
- ✓ **The VAS Diagnostic Tester is plugged in using the supplied power adapters.**
 - Under no circumstances should the tester be used on battery power alone during the software update. Failure to do so may result in the tester powering off during the update, which could result in damage to the control module.
- ✓ **If using the Bluetooth VAS 5054A transmitter head, it is connected to the tester with a USB cable.**

NOTE

Using Bluetooth for this action is PROHIBITED!

Damage caused to electronic components (e.g. ECM, TCM, etc.) during the SVM flash process is not covered.

- Performing a software update using a Bluetooth connection increases the risk of losing connection during the update, which could result in damage to the control module. It also greatly increases the time required to perform the update. Requests for additional time or parts will be denied if the GFF log shows the update was performed using Bluetooth.
- ✓ **The Bluetooth function of the scan tool is physically switched off <see pictures below>.**

The repair information in this document is intended for use only by skilled technicians who have the proper tools, equipment and training to correctly and safely maintain your vehicle. These procedures are not intended to be attempted by “do-it-yourselfers,” and you should not assume this document applies to your vehicle, or that your vehicle has the condition described. To determine whether this information applies, contact an authorized Volkswagen dealer. ©2017 Audi of America, Inc. All Rights Reserved.



VAS 6150 & VAS 6150A
(Front panel behind handle)

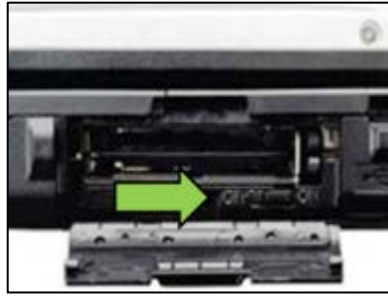

VAS 6150B
(Right side behind WIRELESS door)



VAS 6150C
(Left side behind SC/EX door)

WARNING

Radiator Fan(s) may cycle ON high speed during the Update Process! There is a serious risk that personal injury may result if contact is made with spinning fan blades. Keep hands and all objects away from Radiator Fan(s) during Update Process!

TIP

To Update-Programming using SVM, review and follow instructions in Technical Bulletin 2014603: *Software Version Management (SVM) Operating Instructions*.

The SVM Process must be completed in its entirety so the database receives the update confirmation response. A warranty claim may not be reimbursed if there is no confirmation response to support the claim.

Things to check before starting Software Version Management (SVM):

✓ Check and confirm that you have a LAN connection <arrow>.

✓ Within the Connection Tab, verify that the Connection type(s) display "Internet" <as shown>.

✓ Start a connections test <arrow> and verify that all connections pass.

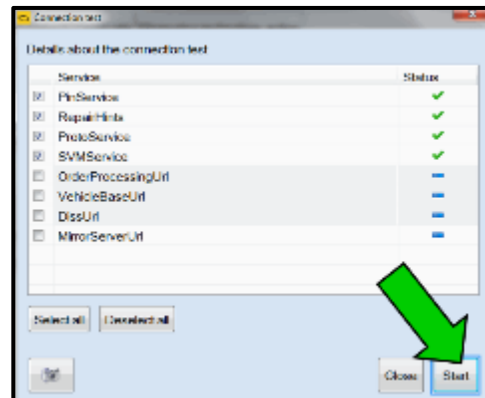
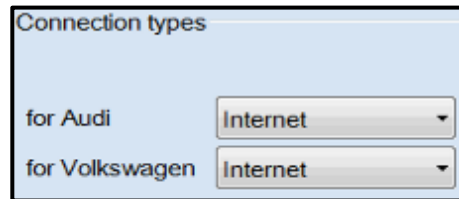



- Open the hood.
- Open the battery cover.
- Attach the GRX3000VAS Tester/Charger (or equivalent) to the vehicle battery jump point and ground jump point.
- Switch the ignition on.
- Apply the parking brake.
- Switch the headlights off.
- Connect the VAS6150X Diagnostic Tester (or equivalent) to the vehicle.
- Start the ODIS program.



NOTE



All TDI flashes **MUST** be completed during a single, standalone ODIS Diagnostic Session. You **MUST** fully complete this campaign and send all GFF Paperless logs before beginning any other campaigns or operations. You **MUST** also conclude any other campaigns or operations that have been started and end the corresponding diagnostic session and send all GFF Paperless logs before beginning this operation. Failure to independently separate the ODIS diagnostic session for this campaign will cause problems updating the FAZIT server in Germany and will delay if not negate the payment of the emissions modification.

IMPORTANT!

If there are any ODIS “Hot-Fix” patches installed, they **MUST** be removed from the scan tool before beginning this operation. ODIS “Hot-Fix” patches may affect the flash process.



- At this time, refer to the “Alerts” section of ServiceNet to verify that the most recent version of ODIS Software is loaded to the VAS6150X Diagnostic Tester (or equivalent). Failure to flash the vehicle using the most recent version of ODIS Diagnostic Software will cause faults in certain features of the flash operation.
- Failure to validate the ODIS Diagnostic version before flashing the vehicle may result in flash failure, and may delay if not negate the payment of the emissions modification.



- Confirm that scan tool is communicating with the diagnostic head by USB <Green Arrow>.
 - If the Bluetooth symbol is shown <Red Arrow> then disconnect the diagnostic head from the vehicle and reconnect the USB cable to the diagnostic head and then reattach to the vehicle.
- Upon ODIS startup, verify the "Diagnosis" operating mode is selected <as shown>.



NOTE

KESY Vehicles!

It is **REQUIRED** to insert the key into the reader coil <arrow>, or place the key in the closest proximity possible to the reader coil throughout the flash process.



NOTE

Before, during, and after the flash process and control module interrogation phases, any number of instrument cluster warning indicators (glow plug, check engine, brake, ABS, etc) may illuminate, flash, or otherwise turn on and off. It is also possible that other interior or exterior components such as radio/infotainment system, lamps, etc. may turn on and off. This is a normal condition during this process. The illumination of instrument cluster lamps (etc) will cease once the ODIS session has ended and the ODIS diagnostic tool is disconnected from the data port.

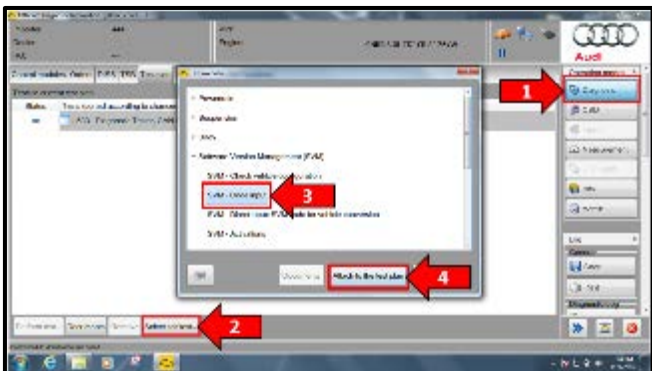

- Upon ODIS startup, select "Diagnosis" <arrow 1>.
- Under the "Test Plan" tab, select "Self Test" <arrow 2>.
- Select "Software Version Management", then select "SVM Code input" <arrow 3>.
- Select "Attach to the test plan" <arrow 4>.

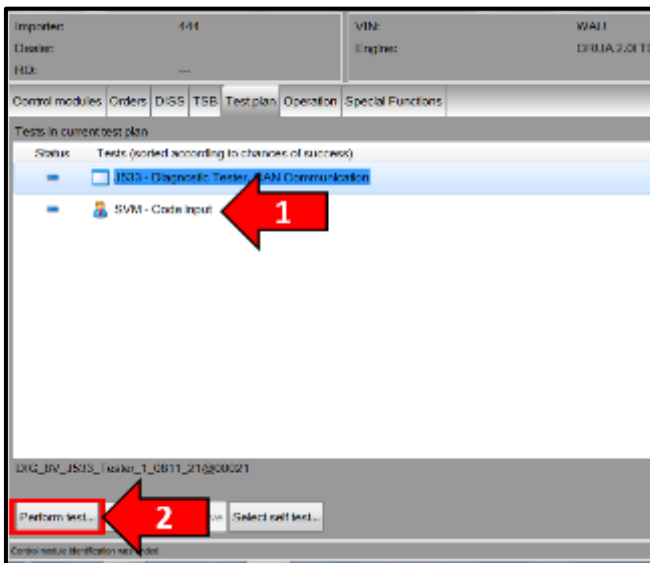

NOTE

RISK of Scan Tool Damage!

- Do not leave the scan tool on the windshield during the flash process, as it is possible that the windshield wipers may cycle.
- From the Test plan screen, Select “SVM Code input” test plan <arrow 1>, then select “Perform test” <arrow 2>.
- Follow the on-screen prompts.

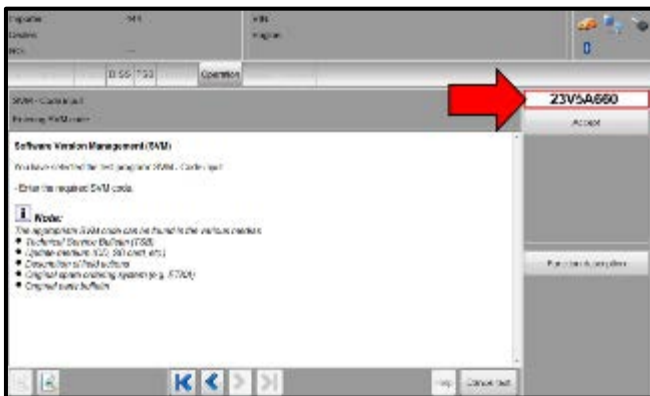

- Enter the corrective action code (SVM code) <arrow> as listed below.

SVM code
23V5A660

- Select “Accept”, and follow the on-screen prompts to complete the flash.

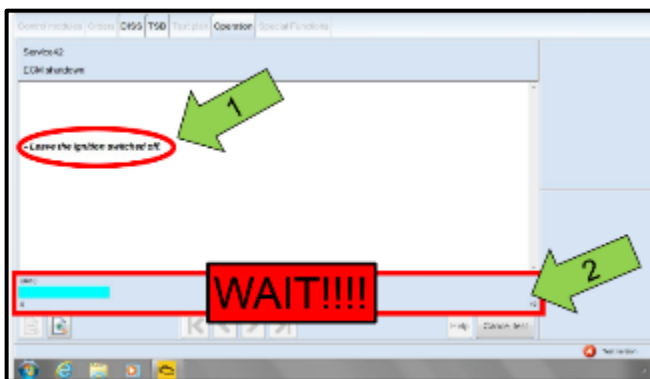

NOTE

- It is **IMPERATIVE** that **ALL** of the ignition cycle on/off delay requests are fulfilled in their entirety during this flash process <arrow 1>.
- Failing to wait for the ignition on/off timing cycle to complete (progress bar and countdown timer <arrow 2>) before cycling the ignition on/off **MAY** damage a control module.
- Damage to control modules as a result of failing to wait the specified time displayed by the progress bar and countdown timer <arrow 2> are **NOT** covered under this action.

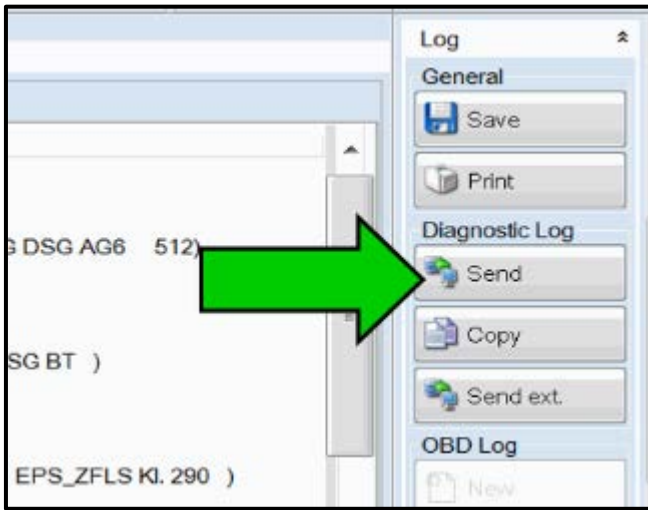

- At the end of the diagnostic session, Select “Send” <arrow> and follow the prompt for sending the log on-line.

NOTE

RISK of Non-payment!

Diagnosis logs must be sent on-line after the flash process to be considered for reimbursement.

TIP

Technicians may find it helpful to also store the log on a USB stick for back-up.

Proceed to Section F.

Section F – Supplemental Vehicle Emissions Control Information Label

AUDI AG		
VEHICLE EMISSION CONTROL INFORMATION		
CONFORMS WITH CONSENT DECREE EMISSIONS COMPLIANT RECALL: 2013 MY		
U.S.EPA: T2B5	LDT4	OBD: CA II FUEL: DIESEL
CALIFORNIA: ULEVII	LDT	OBD: CA II FUEL: DIESEL
NO ADJUSTMENTS NEEDED. DFI/TC/2CAC/OC/PTOX/SCRC/HO2S/NOXS(2)/EGR/PMS		
GROUP: DADXT03.03UG		
EVAP: N/A		059 010 533 BH

Install Supplemental Vehicle Emissions Control Information Label

TIP

- The surface where the label is to be installed must be clean, dry, and free from oil residue prior to installing the label.
- Label must NOT cover any existing label(s).
- Label must be installed in location shown.
- Photo documentation of label installed is required.

AUDI AG		
VEHICLE EMISSION CONTROL INFORMATION		
CONFORMS WITH CONSENT DECREE EMISSIONS COMPLIANT RECALL: 2014 MY		
U.S.EPA: T2B5	LDT4	OBD: CA II FUEL: DIESEL
CALIFORNIA: ULEVII	LDT	OBD: CA II FUEL: DIESEL
NO ADJUSTMENTS NEEDED. DFI/TC/2CAC/OC/DPF/SCRC/HO2S/NOXS(2)/EGR/PMS		
GROUP: EADXT03.03UG		
EVAP: N/A		059 010 533 BJ



AUDI AG		
VEHICLE EMISSION CONTROL INFORMATION		
CONFORMS WITH CONSENT DECREE EMISSIONS COMPLIANT RECALL: 2015 MY		
U.S.EPA: T2B5	LDT4	OBD: CA II FUEL: DIESEL
CALIFORNIA: ULEVII	LDT	OBD: CA II FUEL: DIESEL
NO ADJUSTMENTS NEEDED. DFI/TC/2CAC/OC/DPF/SCRC/WR-HO2S/NOXS(2)/EGR/EGRC/PMS		
GROUP: FVGAT03.0NU3		
EVAP: N/A		059 010 533 BK



- Open the hood.
- Clean the surface where the label is to be installed <circle>.
- Install the Supplemental Vehicle Emissions Control Information (VECI) label according to the chart below on the underside of the hood or onto the core support. The Supplemental Vehicle Emissions Control Information (VECI) label and TDI Recall Proof of Completion label should be placed next to each other so that a single photograph can capture both labels.

Vehicle	Label part number
MY 2013	059 010 533 BH
MY 2014	059 010 533 BJ
MY 2015	059 010 533 BK

 NOTE
<p><i>DO NOT Cover <u>ANY</u> existing labels!</i></p>



Proceed to Section G

Section G – TDI Recall Proof of Completion Label

TDI RECALL PROOF OF COMPLETION
 THE EMISSIONS RECALL REPAIRS INDICATED BELOW WERE COMPLETED ON THIS VEHICLE:

3.0L GEN 2.1 SUV – 2013 - 2014 MODEL YEAR – Q7

RECALL CODE: []

DEALER CODE: []

REPAIR DATE: []

DO NOT REMOVE
4L010023 B

W0000001

SOFTWARE UPDATE
 SCR CATALYST
 TURBINE MIXER AND DEF DOSING VALVE
 PM SENSOR
 CYLINDER PRESSURE SENSOR

TDI RECALL PROOF OF COMPLETION
 THE EMISSIONS RECALL REPAIRS INDICATED BELOW WERE COMPLETED ON THIS VEHICLE:

3.0L GEN 2.1 SUV – 2015 MODEL YEAR – Q7

RECALL CODE: []

DEALER CODE: []

REPAIR DATE: []

DO NOT REMOVE
4L010023 A

W0000001

SOFTWARE UPDATE
 SCR CATALYST
 TURBINE MIXER AND DEF DOSING VALVE
 PM SENSOR



Install TDI Recall Proof of Completion label

TIP

- The surface where the label is to be installed must be clean, dry, and free from oil residue prior to installing the label.
- Label must NOT cover any existing label(s).
- Photo documentation of label installed is required.

- Clean the surface next to the Vehicle Emission Control Information Label where the TDI Recall Proof of Completion label is to be installed.
- Fill out completely the Recall Code, Dealer Code, and Repair Date.
- Affix the TDI Recall Proof of Completion label and verify that the correct part number is being installed according to chart below onto the underside of the hood or onto the core support. The TDI Recall Proof of Completion label and Supplemental Vehicle Emissions Control Information (VECI) label should be placed next to each other so that a single photograph can capture both labels.

Vehicle	Label part number
MY 2013 - 2014	4L0 010 023 B
MY 2015	4L0 010 023 A

NOTE

DO NOT Cover ANY existing labels!

- Apply clear overlay (provided)
- Close the hood



Proceed to Section H

Section H – Service Modification Documentation Requirements

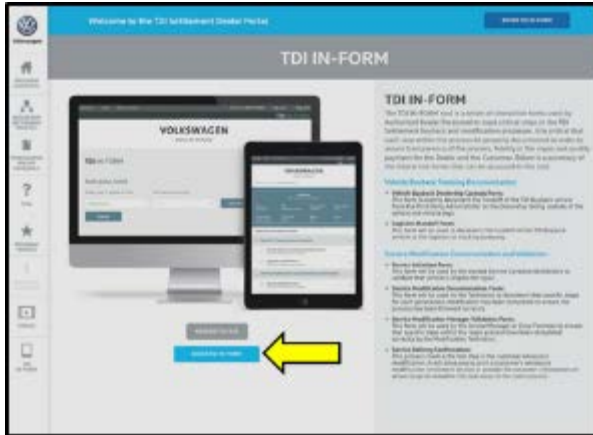

Job Roles Summary:

- *Service Consultant – Initiates validation tool.*
- *Service Technician – Completes service modification requirements.*
- *Manager – Validates the modification was properly completed.*
- *Dealer Representative/Cashier – Prints receipt, fuel economy label and delivers to customer.*
- *Warranty Administrator – Enters claim into the SAGA system.*

TIP

To access the interactive forms go to the TDI Settlement Program microsite on vwhub.com. Then Select the “TDI IN-FORM” Button from the lower left side of the microsite navigation.

- Enter the “TDI IN-FORM” tool <arrow>
- Enter the VIN for the vehicle that requires documentation.

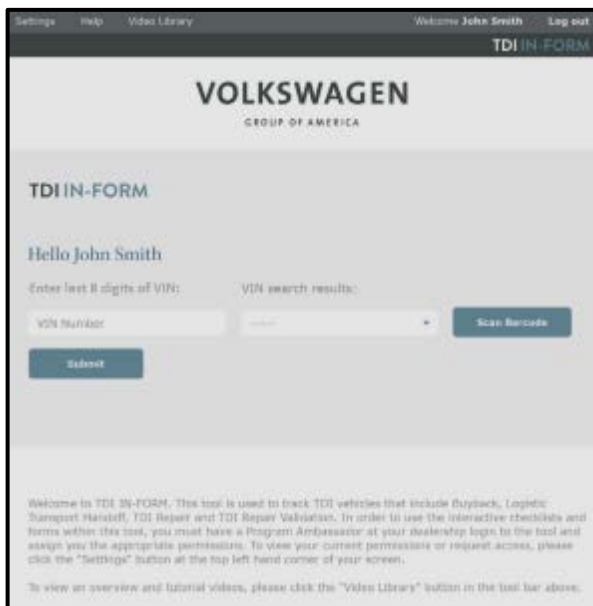

TIP

The VIN can be manually typed in or using an iPad or iPhone running iOS 9+, the camera can be used to scan the VIN Barcode.
Please note ambient lighting, camera quality, etc. may impact the effectiveness of the VIN scanning feature.

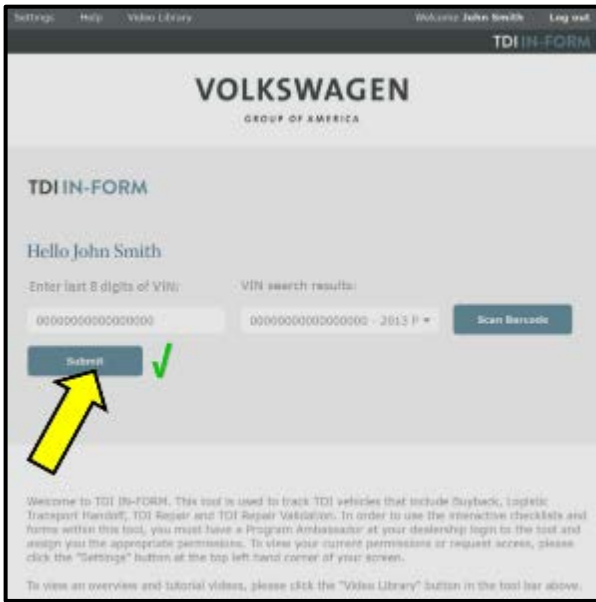

TIP

After the VIN has been entered, the system will automatically validate that it is a TDI VIN. This will be indicated by a green check mark that will appear next to the VIN.

- Validate the VIN is correct for the vehicle, then click the "Submit" button <arrow>.

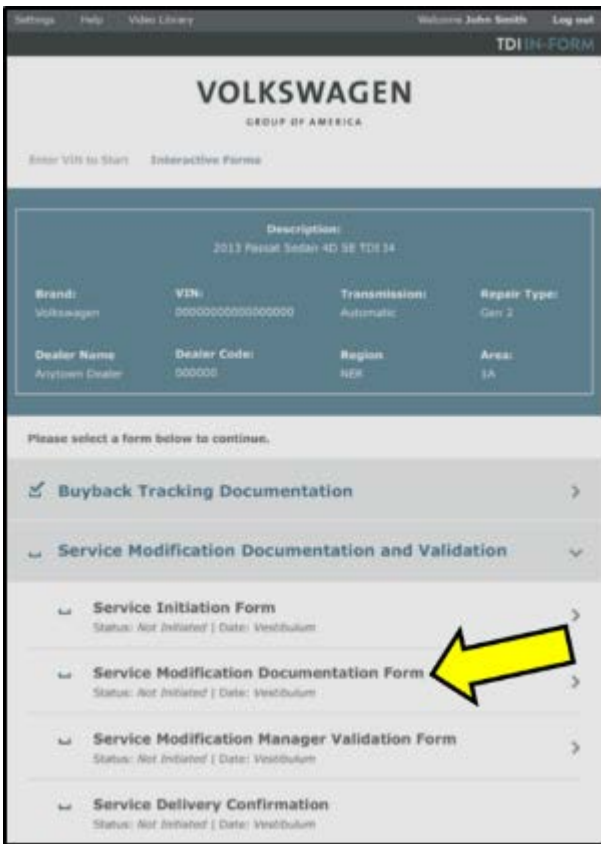

- Select "Service Modification Documentation Form" <arrow>.
- Follow the on-screen prompts completely.

NOTE

RISK of Non-payment!

Not using the IN-FORM tool to document and validate the modification will stop the processing of payment for your dealership even if the modification has been completed.

TIP

Upon completion of the Service Modification Documentation Form, the Manager must validate the repair in the IN-FORM tool.

Proceed to Section I

Section I – Campaign Stamp

I certify that this campaign
has been performed in strict
accordance with the applicable
Audi repair procedure.

SAGA Code: _____

Technician: _____

Date: _____

Item#: AUD4927ENG

OR

Je certifie que cette
campagne de rappel a été
exécutée suivant les strictes
directives de réparation
d'Audi

Code de SAGA: _____

Technicien: _____

Date: _____

Item # AUD4927FRE

- Once the campaign has been completed, the technician should stamp the repair order.
- Stamps are available for ordering through the Compliance Label Ordering Portal (item# AUD4927ENG or AUD4927FRE).

Proceed to Section J

Section J – Parts Return



Parts Return/Disposal

SCR Catalyst:

- The SCR Catalyst must be tagged with a blue zip tie <as shown> and returned in order to be considered for core charge reimbursement.

All other parts:

- Properly store (retain), destroy or dispose of removed parts in accordance with all state and local requirements, unless otherwise indicated and/or requested through the Warranty Parts Portal (WPP).

All Work Complete

Proceed to Section K for California Only

Section K – California Only Requirements

CALIFORNIA ONLY Requirements for Emissions Campaigns Having Customer Notification

The California Air Resources Board and the Department of Motor Vehicles (DMV) require emissions-related campaigns to be completed prior to vehicle registration renewal. **When campaign work is done you must provide the owner with a signed “Vehicle Emission Recall – Proof of Correction” certificate (RC EMIS_CAL VW).** Certificates can be ordered at no cost online via the Compliance Label Ordering portal at www.accessaudi.com.

TIP

Ensure owners are aware of the importance of retaining the completed certificate for their records. It should be mailed to the California DMV only upon request.

Appendix A – Warnings and Safety Precautions

WARNING

Note the following when working on the whole exhaust system:

- Danger of eye injury, wear protective eyewear
- Wear gloves (for example rubber gloves, not cloth gloves) and protective eyewear to prevent any harmful contact with the skin and eyes - risk of injury.
- Do not remove the exhaust gas temperature sensor - risk of injury.

WARNING

The reducing agent can cause skin irritation.

- To prevent large amounts of reducing agent from leaking out when opening the metering line, wait for the recirculation process to be completed.
- Avoid contact with skin and eyes! Wear protective gloves!
- If reducing agent should get on your skin, wash it off immediately with soap and water.
- If reducing agent gets in your eye, rinse the eye for several minutes with water.
- Never inhale or swallow the reducing agent!
- Should you swallow any reducing agent, rinse your mouth, drink plenty of water and contact a doctor immediately.

Appendix B – 3.0L Gen 2.1 Parts Kit

Kit	Part Number	Part Description	Quantity	Diagram Location
4L0 298 099 X Gen 2.1 Kit	7P0 254 400 BX	Exhaust Pipe With Catalyst And Adapters	1	1
	7L5 253 115 C	Gasket	1	5
	1K0 253 141 J	Dual Clamp	1	2
	N 91130802	Shouldered Hex Nut	3	4
	N 01024713	Replacement Stud/Bolt	3	6
	4H0 131 113 A	Injector For Reduction Agent	1	7
	3C0 253 725	Retaining Clamp	1	9
	059 906 261	PM Sensor	1	3 / 11

