

Toyota Safety Sense Front Camera Optical Axis Learning Information

Service Category Vehicle Interior

Section Pre-Collision Safety

Market USA

Toyota Supports
 ASE Certification 

Applicability

YEAR(S)	MODEL(S)	ADDITIONAL INFORMATION
2016 - 2017	Avalon, Avalon HV, Land Cruiser, Prius, Prius C, RAV4, RAV4 HV	
2017	Corolla, Highlander, Highlander HV, Prius Prime, Yaris	

Introduction

This Service Bulletin includes precautions and key points for the front camera for Toyota Safety Sense C and Toyota Safety Sense P adjustment procedures.

Situations in which front camera optical axis learning is necessary:

- The front camera has been replaced.
- The windshield glass has been replaced or removed and installed.
- When the following DTCs are output:
 - Toyota Safety Sense C:
 - C1AA8: Front Camera Module Incorrect Axial Gap.
 - C1AA9: Front Camera Module Beam Axis NOT Adjusting.
 - Toyota Safety Sense P:
 - C1AA9: Front Camera Module Beam Axis NOT Adjusting.

Contents

SUBJECT	PAGE
Adjustment Procedure	2
Purpose of Front Camera Optical Axis Learning	3
Characteristics of the Front Camera	4
Hints for Performing Optical Axis Learning	7
How to Prevent a Background Object From Being Recognized as a Target	13

Toyota Safety Sense Front Camera Optical Axis Learning Information

Warranty Information

OP CODE	DESCRIPTION	TIME	OFF	T1	T2
N/A	Not Applicable to Warranty	–	–	–	–

Adjustment Procedure

Refer to the Technical Information System (TIS) applicable model and model year Repair Manual for the adjustment procedure:

- 2016 – 2017 Avalon:
Engine/Hybrid System – Cruise Control – “Cruise Control: Front Camera: [Adjustment](#)”
- 2016 – 2017 Avalon HV:
Engine/Hybrid System – Cruise Control – “Cruise Control: Front Camera: [Adjustment](#)”
- 2017 Corolla:
Engine/Hybrid System – Cruise Control – “Cruise Control: Front Camera: [Adjustment \(Sequential Recognition\)](#)”
- 2017 Highlander:
Engine/Hybrid System – Cruise Control – “Cruise Control: Front Camera: [Adjustment \(Sequential Recognition\)](#)”
- 2017 Highlander HV:
Engine/Hybrid System – Cruise Control – “Cruise Control: Front Camera: [Adjustment \(Sequential Recognition\)](#)”
- 2016 – 2017 Land Cruiser:
Engine/Hybrid System – Cruise Control – “Cruise Control: Front Camera: [Adjustment](#)”
- 2016 – 2017 Prius:
Engine/Hybrid System – Cruise Control – “Cruise Control: Front Camera: [Adjustment \(Sequential Recognition\)](#)”
- 2016 – 2017 Prius C:
Vehicle Interior – Pre-Collision Safety – “Pre-Collision: Front Sensor: [Adjustment](#)”
- 2017 Prius Prime:
Engine/Hybrid System – Cruise Control – “Cruise Control: Front Camera: [Adjustment \(Sequential Recognition\)](#)”
- 2016 – 2017 RAV4:
Engine/Hybrid System – Cruise Control – “Cruise Control: Front Camera: [Adjustment](#)”
- 2016 – 2017 RAV4 HV:
Engine/Hybrid System – Cruise Control – “2AR-FXE Cruise Control: Front Camera: [Adjustment](#)”
- 2017 Yaris:
Vehicle Interior – Pre-Collision Safety – “Pre-Collision: Front Sensor: [Adjustment](#)”

Toyota Safety Sense Front Camera Optical Axis Learning Information

Purpose of Front Camera Optical Axis Learning

If the installation position or orientation of the front camera is changed due to it being replaced with a NEW one or the windshield glass sub-assembly being replaced or removed and installed, it is necessary to perform front camera optical axis learning for the front camera to learn the driving direction of the vehicle and its horizontal axis in order for each driving support system (Pre-Collision System [PCS], Lane Departure Alert [LDA], Automatic High Beams [AHB], etc.) to operate correctly.

Figure 1. NEW Camera BEFORE Adjustment

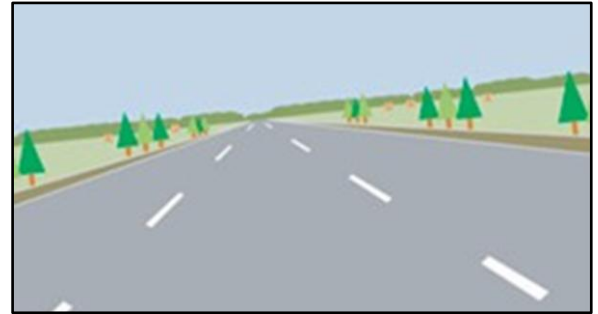
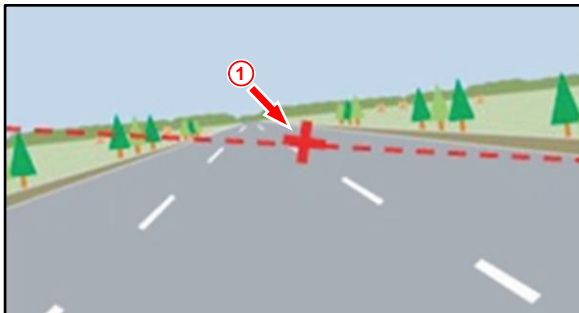
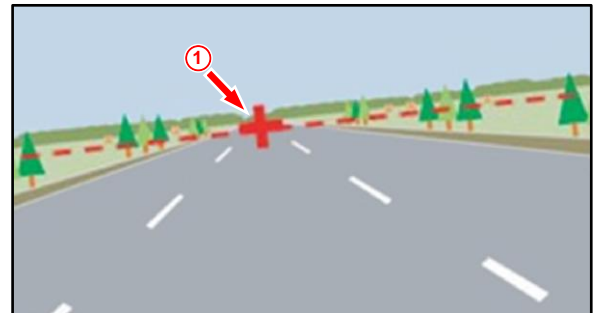

Figure 2. Front Camera Reused AFTER Replacement or Removal/Installation of Windshield Glass Sub-Assembly BEFORE Adjustment



1	Previously Learned Optical Axis
----------	---------------------------------

Figure 3. AFTER Adjustment



1	Learned Optical Axis
----------	----------------------

Figure 4. AFTER Adjustment

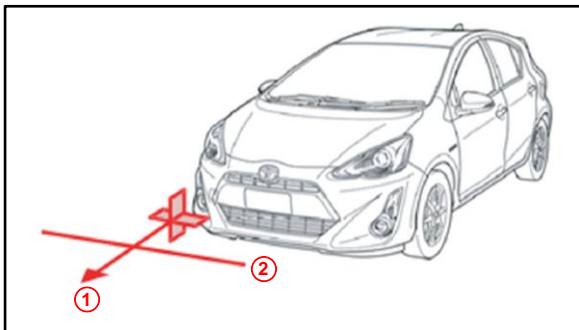

1	Driving Direction
2	Horizontal Plane

Toyota Safety Sense Front Camera Optical Axis Learning Information

Characteristics of the Front Camera

1. How the front camera recognizes a target:

The front camera operates through recognition of differences in contrast. A high contrast checkered flag pattern target is used when performing learning.

Figure 5.

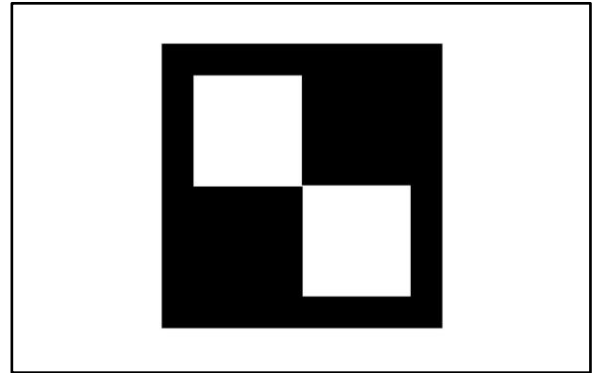

2. How differences in contrast are recognized by the front camera:

- What the front camera recognizes as high contrast is NOT limited to what appears as black and white to the human eye.
- Depending on how light strikes the target used for learning, the white part of the target may look dark to the front camera and the contrast will be detected as low.
- If there are overhead lights, windows, reflective objects, or high contrast objects behind the target, the contrast will be detected as high.

Figure 6. Image Seen by Human Eye



Figure 7. Image Processed by Camera

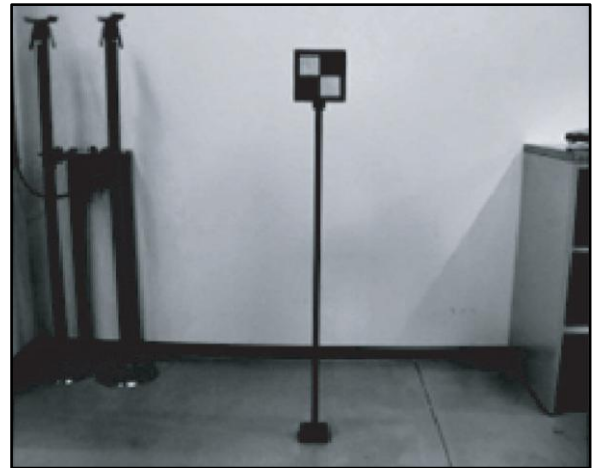

Toyota Safety Sense Front Camera Optical Axis Learning Information

Characteristics of the Front Camera (Continued)

Figure 8.

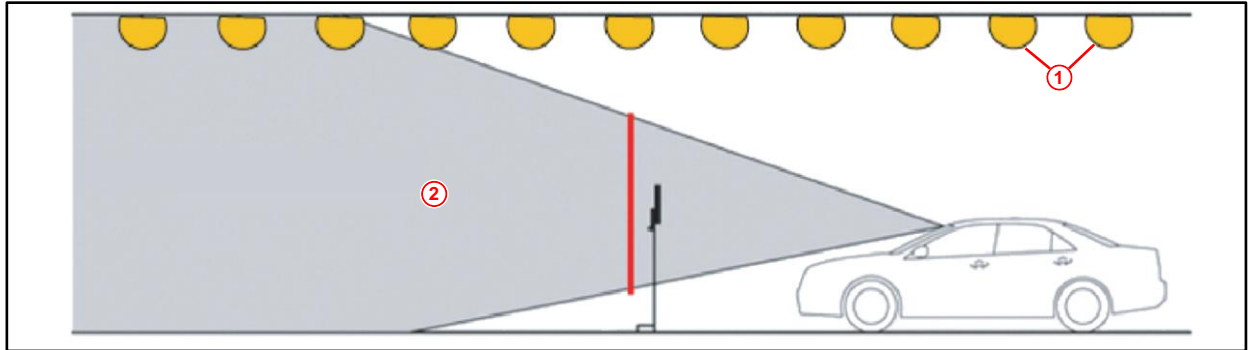

1	Overhead Lights
----------	------------------------

2	Front Camera Detection Area
----------	------------------------------------

Figure 9. Image Seen by Human Eye



Figure 10. Contrast is Low Due to Insufficient Light Striking the Target



Figure 11. Image Seen by Human Eye



Figure 12. In the Image Processed by the Camera, the Difference in Contrast Between the Target and Objects in the Background is High

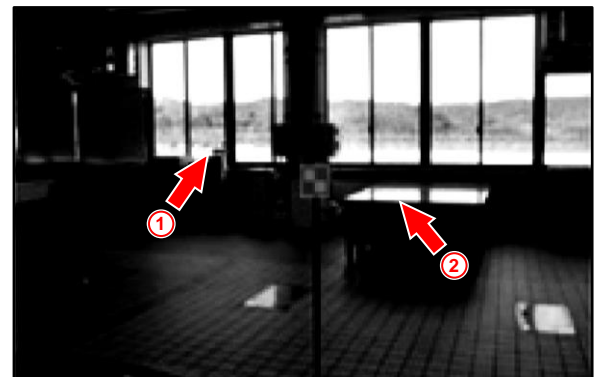

1	Window and Window Frames
2	Reflective Objects Near the Windows

Toyota Safety Sense Front Camera Optical Axis Learning Information

Characteristics of the Front Camera (Continued)

Figure 13. Image Seen by Human Eye



Figure 14. In the Image Processed by the Camera, the Difference in Contrast Between the Target and Objects in the Background is High

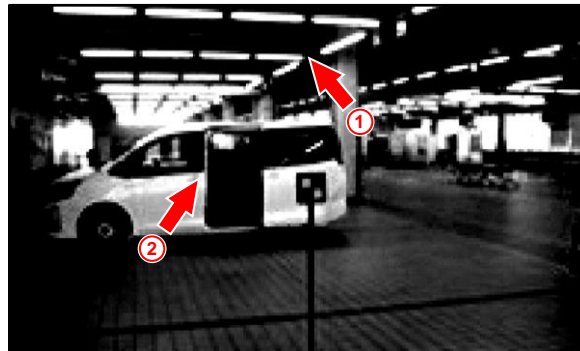

1	Overhead Lights
2	White Vehicle Body and Interior Shadow

Toyota Safety Sense Front Camera Optical Axis Learning Information

Hints for Performing Optical Axis Learning

1. Condition required to detect targets appropriately:
The target is placed in an area where the black and white parts of the target can be detected by the camera as being in high contrast.
2. Conditions under which the target cannot be detected:

- A. Light shining from behind the target (backlit).

As the target will appear dark to the camera if the target is backlit, the contrast of the black and white parts of the target will decrease and the target may NOT be recognized.

Figure 15.

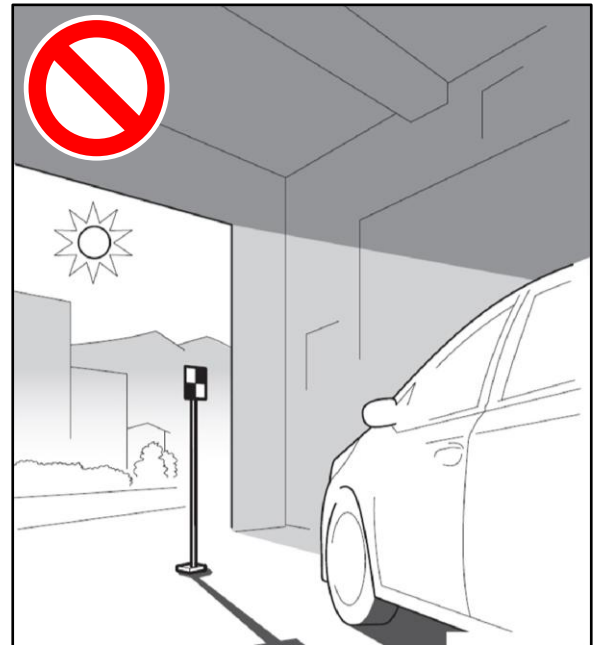

- B. Target partially illuminated by light from windows.

If the surface of the target is unevenly illuminated, the contrast of the black and white parts of the target will decrease and the target may NOT be recognized.

Figure 16.

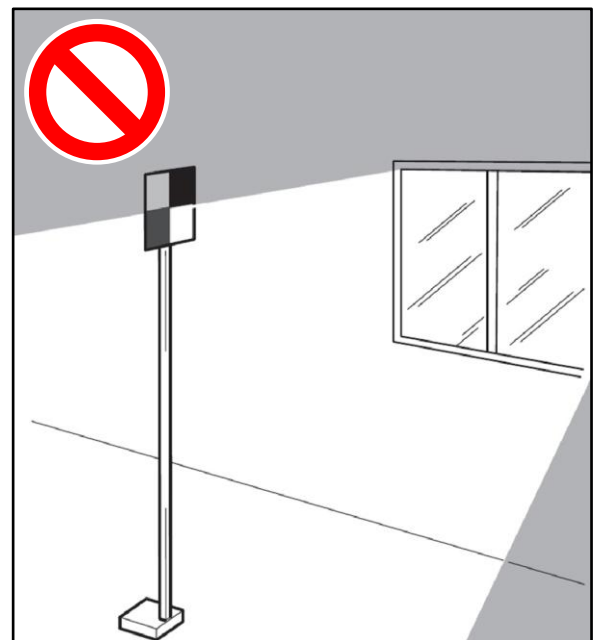

Toyota Safety Sense Front Camera Optical Axis Learning Information

Hints for Performing Optical Axis Learning (Continued)

- C. Entire target is NOT illuminated.
If the target is placed in an area that is dark, the contrast between the target and the background will decrease and the target may NOT be recognized.

Figure 17.

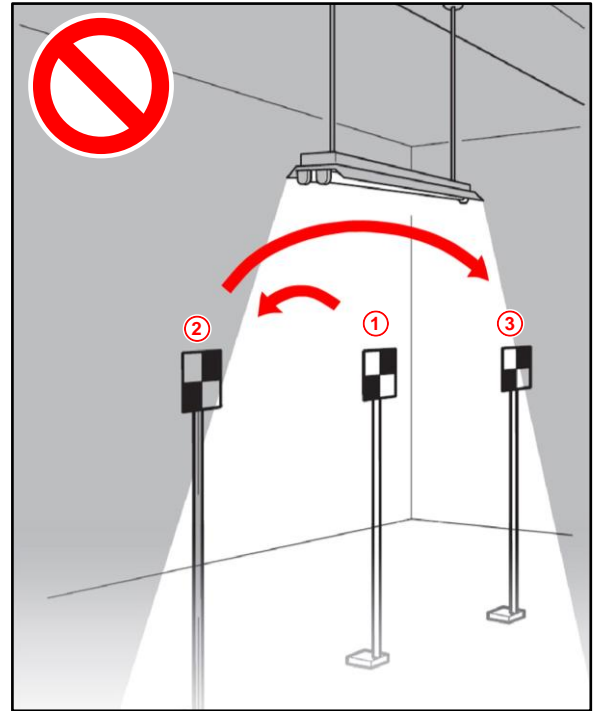

1	Target Properly Illuminated
2	Target NOT Illuminated
3	Target Surface Partially Illuminated

Figure 18.



Toyota Safety Sense Front Camera Optical Axis Learning Information

Hints for Performing Optical Axis Learning (Continued)

D. Reflective object on target surface.

If an object, such as clear adhesive tape, is attached to the target surface or if the target is laminated, the target surface will reflect light. As the reflected light will appear white to the camera, the target may NOT be recognized.

Figure 19.

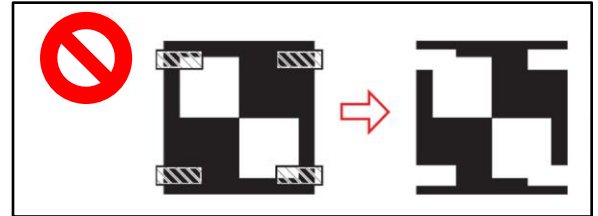
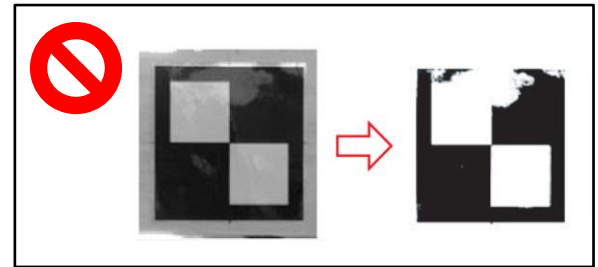

Figure 20.



E. Border of black and white parts of the target are blurry or distorted.

If the borders of the black and white parts of the target appear blurry to the camera, the detected contrast will be low and the target may NOT be recognized. Also, if the borders are distorted, the target may NOT be recognized.

Figure 21.

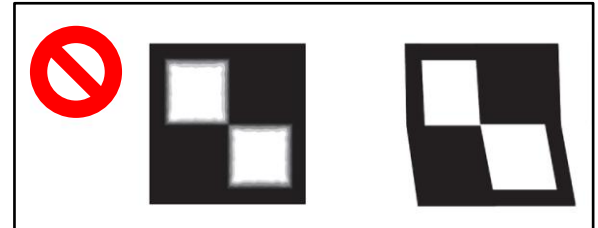

Toyota Safety Sense Front Camera Optical Axis Learning Information

Hints for Performing Optical Axis Learning (Continued)

3. Condition required to complete optical axis learning:
 The front camera MUST detect 3 targets in a line.

4. Conditions under which optical axis learning cannot be completed:
 Target misrecognition due to high contrast object in background.
 - If there are lights or reflective or shiny objects in front of the vehicle, they may appear white to the camera and be recognized as a target, as their contrast will be higher than the actual target.
 - If something other than the printed target is recognized as a target, the learned target position will be incorrect. In this case, optical axis learning will NOT be completed as the detected targets will have NOT been aligned.

Figure 22.

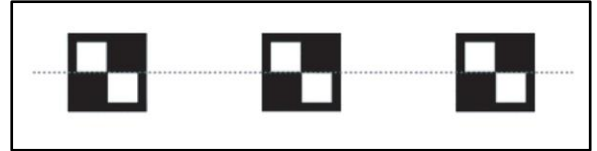
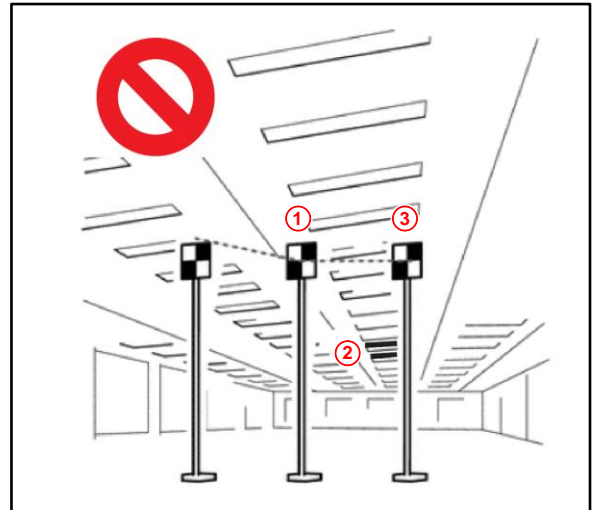

Figure 23.



1	Normal Target Recognized
2	Something Other Than Target Recognized
3	Normal Target Recognized

Toyota Safety Sense Front Camera Optical Axis Learning Information

Hints for Performing Optical Axis Learning (Continued)

5. Examples of areas where optical axis learning would fail:

A. Targets cannot be recognized.

Figure 24. White Areas NOT Visible



Figure 25. Black Area Blends With Background



B. Object in the background is misrecognized as a target.

Figure 26. Objects Misrecognized as Targets



Figure 27. Target Blends With Vehicle, Object Recognized as Target

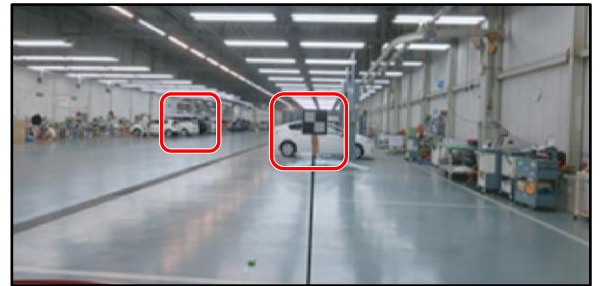

Figure 28. Objects Recognized as Targets



Figure 29. Objects Recognized as Targets



Toyota Safety Sense Front Camera Optical Axis Learning Information

Hints for Performing Optical Axis Learning (Continued)

C. Targets NOT recognized as being aligned.

Figure 30. Shadow on Target



Figure 31. High Contrast Background



Toyota Safety Sense Front Camera Optical Axis Learning Information

How to Prevent a Background Object From Being Recognized as a Target

90% of reported optical axis learning failures were due to an object in the background being misrecognized as a target, resulting in the 3 targets NOT being recognized as aligned. Refer to the following countermeasures to prevent this:

1. Block the area behind the target.

By blocking objects behind the target which may be misrecognized as a target, the front camera can more easily recognize the target and complete optical axis learning. In order to do so, block the area behind the target from the view of the camera.

Figure 32.

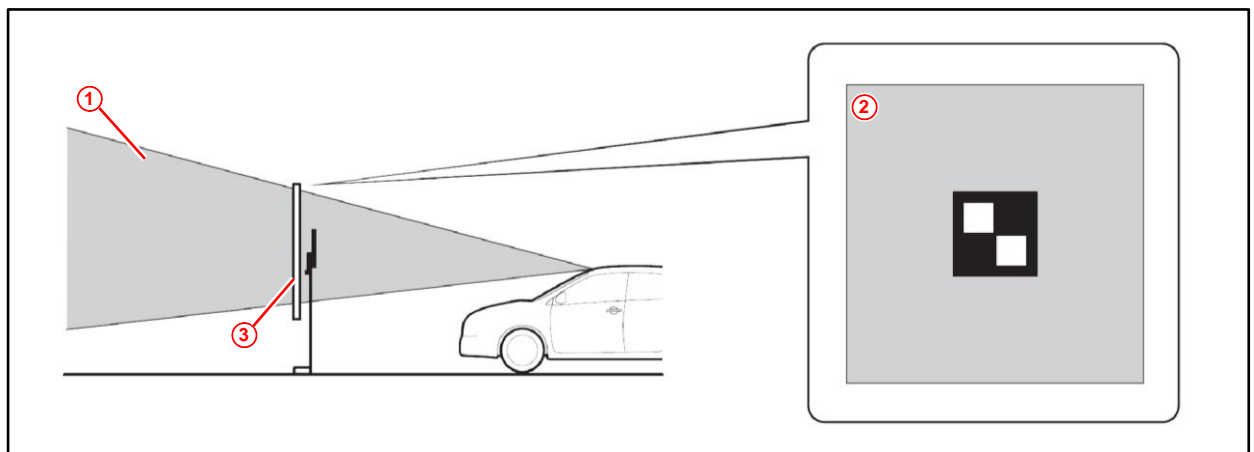

1	Front Camera Detection Area
3	Block This Area

2	Area to be Blocked
---	--------------------

2. Use a plain light colored object to block the area behind the target.

Make sure the object is free of wrinkles, fold lines and is non-reflective. A board or piece of cardboard or cloth would be an appropriate object. Target recognition is easier to perform if the object is made of a light colored material.

NOTE

Wrinkles or fold lines in the object may create shadows, leading to differences in contrast in the image processed by the front camera. If an object with pattern is used, depending on the color, the differences in contrast of the pattern may be misrecognized as a target.

Toyota Safety Sense Front Camera Optical Axis Learning Information

How to Prevent a Background Object From Being Recognized as a Target (Continued)

Areas to be blocked are as listed in the following table:

Prepare a blocking object with the following amount of blank space in order to prevent a hand or masking tape (which is used to hold the blocking object) from entering the detection area of the front camera. As the distance between the target and blocking object increases, the area necessary to be blocked increases.

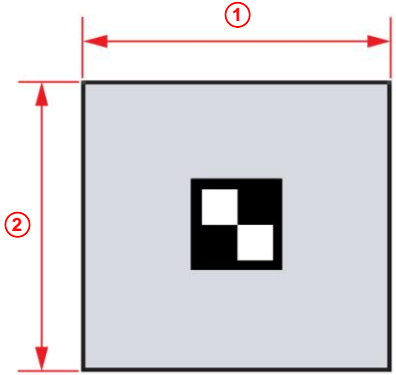
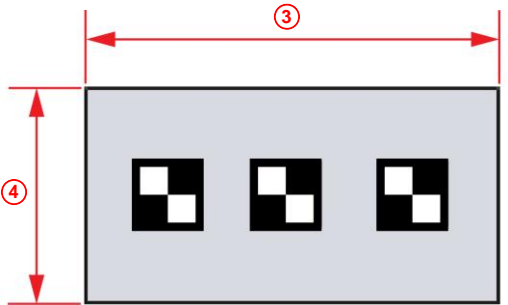
RECOGNITION METHOD	SYSTEM TYPE	AREA TO BE BLOCKED*
Sequential Recognition	Toyota Safety Sense C Toyota Safety Sense P	
One Time Recognition	Toyota Safety Sense C	

* Area necessary to block if the blocking object is placed immediately behind the target.

1	840 mm (33.07 in.) or More
2	840 mm (33.07 in.) or More

3	1160 mm (45.67 in.) or More
4	560 mm (22.05 in.) or More

Toyota Safety Sense Front Camera Optical Axis Learning Information

How to Prevent a Background Object From Being Recognized as a Target (Continued)

3. Precautions for blocking the background:

- When blocking the background of the target, have someone hold the blocking object or attach it to a whiteboard, etc.
- Make sure the object is held so that there are no wrinkles or fold lines, and that hands and ANY kind of tape are outside of the front camera detection area.

Figure 33.

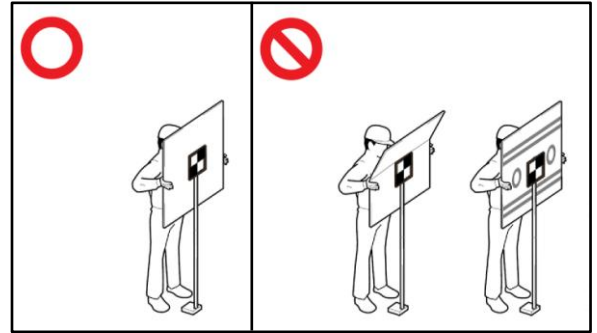

Figure 34.

