



# Special Tools Bulletin

TITLE:

**Newsletter 64: Mandatory Tools**

NO: 211	ISSUE DATE: 2015-05-04	CAR MARKET: United States and Canada	Page 1 of 13
	STATUS DATE: 2017-10-09		

**“Right first time in Time”**

**Bosch Automotive Service Solutions**  
28635 Mound Road  
Warren, MI 48092  
Visit [volvodealersolutions.com](http://volvodealersolutions.com)  
Call 1-800-345-3399

All tools have been classified as required, and will be allocated to all U.S. and Canadian Volvo retailers by Bosch Corporation. U.S. retailers will be billed by Volvo Cars of North America, LLC.

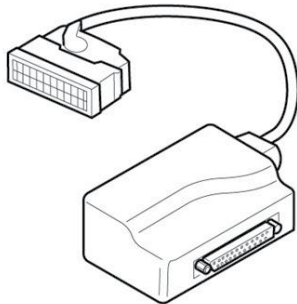

## 9513061 VDDM+BDM Adapter

Break Out Box Adapter for fault tracing the Brake Control Module and the Vehicle Dynamics Domain Master.

<b>Tool standard</b>	C2
<b>Tool group</b>	39
<b>Tool bulletin</b>	383
<b>Model</b>	XC90 (16-)
<b>Tool board</b>	Electrical cabinet
<b>Price</b>	

Service Personnel: Read and initial	SERVICE MANAGER	PARTS MANAGER	WORKSHOP FOREMAN	SERVICE TECHNICIANS													

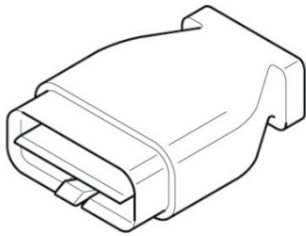

## 9513062 VOE Adapter

Break Out Box Adapter for onboard diagnostic (OBD).

**NOTE: Superseded to 9513108, see Newsletter 73.**

**NOTE: 9513062 should no longer be used.**

<b>Tool standard</b>	C1
<b>Tool group</b>	39
<b>Tool bulletin</b>	383
<b>Model</b>	XC90 (16-)
<b>Tool board</b>	Electrical cabinet
<b>Price</b>	

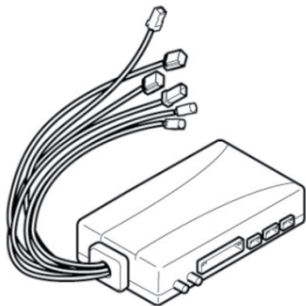

## 9513063 VCM Adapter

Break Out Box Adapter for fault tracing Vehicle Connectivity Module.

<b>Tool standard</b>	C2
<b>Tool group</b>	39
<b>Tool bulletin</b>	383
<b>Model</b>	XC90 (16-)
<b>Tool board</b>	Electrical cabinet
<b>Price</b>	

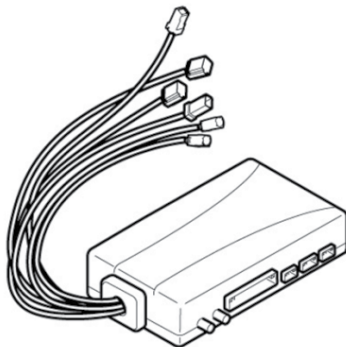

## 9513064 CEM Adapter

Break Out Box Adapter for fault tracing in the CEM system “Central Electric Module”.

<b>Tool standard</b>	C1
<b>Tool group</b>	39
<b>Tool bulletin</b>	383
<b>Model</b>	XC90 (16-)
<b>Tool board</b>	Electrical cabinet
<b>Price</b>	

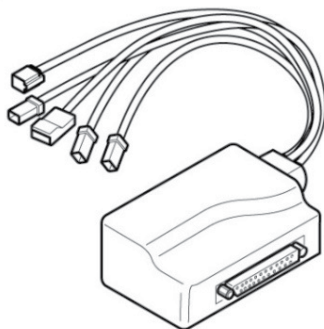

## 9513065 SWM SAS Adapter

Break Out Box Adapter for fault tracing on Steering Wheel Module and Steering Angle Sensor.

<b>Tool standard</b>	C2
<b>Tool group</b>	39
<b>Tool bulletin</b>	383
<b>Model</b>	XC90 (16-)
<b>Tool board</b>	Electrical cabinet
<b>Price</b>	

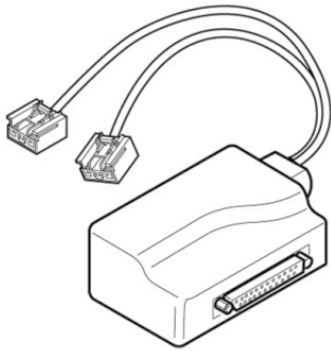

## 9513066 DDM-PDM/RPDDM Adapter

Break Out Box Adapter for fault tracing Driver Door Module, Passenger Door Module, and Rear Passenger Drive Door Module.

<b>Tool standard</b>	C2
<b>Tool group</b>	39
<b>Tool bulletin</b>	383
<b>Model</b>	XC90 (16-)
<b>Tool board</b>	Electrical cabinet
<b>Price</b>	

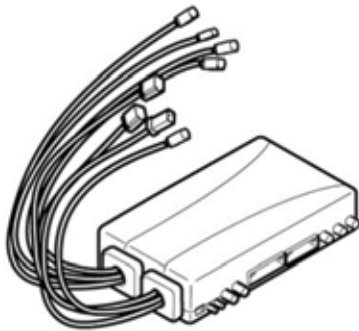

## 9513067 IHU Adapter

Break Out Box Adapter for fault tracing Infotainment Head Unit.

<b>Tool standard</b>	C2
<b>Tool group</b>	39
<b>Tool bulletin</b>	383
<b>Model</b>	XC90 (16-)
<b>Tool board</b>	Electrical cabinet
<b>Price</b>	

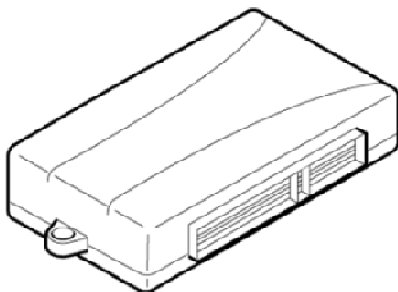

## 9513068 SRS Adapter

For troubleshooting the SRS system “Supplemental Restraint System”.

<b>Tool standard</b>	C1
<b>Tool group</b>	39
<b>Tool bulletin</b>	383
<b>Model</b>	XC90 (16-)
<b>Tool board</b>	Electrical cabinet
<b>Price</b>	

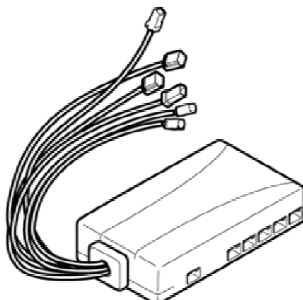

## 9513069 WAM Adapter

WAM Adapter for fault tracing on Wide Angle Vision Module.

<b>Tool standard</b>	C2
<b>Tool group</b>	39
<b>Tool bulletin</b>	383
<b>Model</b>	XC90 (16-)
<b>Tool board</b>	Electrical cabinet
<b>Price</b>	

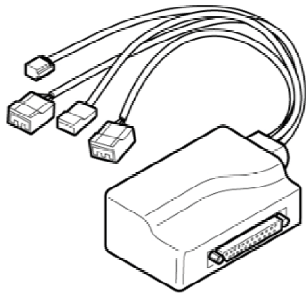

## 9513070 AUD Adapter

Break Out Box Adapter for fault tracing Audio Module.

<b>Tool standard</b>	C2
<b>Tool group</b>	39
<b>Tool bulletin</b>	383
<b>Model</b>	XC90 (16-)
<b>Tool board</b>	Electrical cabinet
<b>Price</b>	

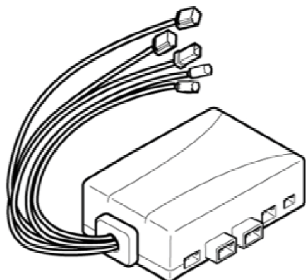

## 9513071 TVM Adapter

Break Out Box Adapter for fault tracing Television Module.

<b>Tool standard</b>	C2
<b>Tool group</b>	39
<b>Tool bulletin</b>	383
<b>Model</b>	XC90 (16-)
<b>Tool board</b>	Electrical cabinet
<b>Price</b>	

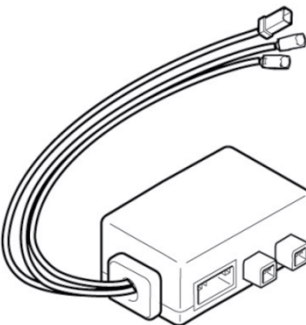

## 9513072 DIM Adapter

Break Out Box Adapter for fault tracing Driver Information Module.

<b>Tool standard</b>	C2
<b>Tool group</b>	39
<b>Tool bulletin</b>	383
<b>Model</b>	XC90 (16-)
<b>Tool board</b>	Electrical cabinet
<b>Price</b>	



## 9513073 ASDM SODLR RML/RMR Adapter

Break Out Box Adapter for fault tracing Active Safety Domain Master, Side Obstacle Detection Left/Right, Restraint Module Left and Restraint Module Right.

<b>Tool standard</b>	C1
<b>Tool group</b>	39
<b>Tool bulletin</b>	383
<b>Model</b>	XC90 (16-)
<b>Tool board</b>	Electrical cabinet
<b>Price</b>	

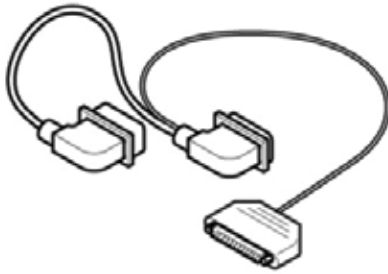

## 9513074 BECM Adapter

Break Out Box Adapter for fault tracing Battery Electronic Control Module.

<b>Tool standard</b>	C1
<b>Tool group</b>	39
<b>Model</b>	XC90 (16-)
<b>Tool board</b>	Electrical cabinet
<b>Price</b>	

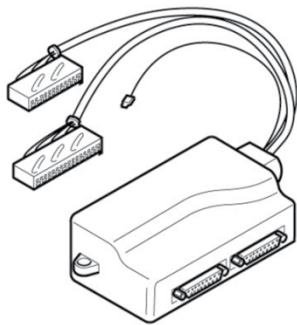

## 9513075 SUM Adapter

Break Out Box Adapter for fault tracing Suspension Module.

<b>Tool standard</b>	C2
<b>Tool group</b>	39
<b>Tool bulletin</b>	383
<b>Model</b>	XC90 (16-)
<b>Tool board</b>	Electrical cabinet
<b>Price</b>	

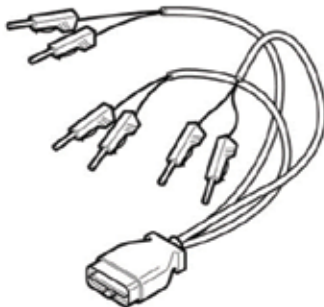

## 9513076 OBD Adapter

Break Out Box Adapter for fault tracing CAN, Flexray.

<b>Tool standard</b>	C1
<b>Tool group</b>	39
<b>Tool bulletin</b>	383
<b>Model</b>	XC90 (16-)
<b>Tool board</b>	Electrical cabinet
<b>Price</b>	

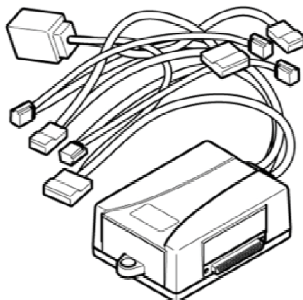

## 9513077 POT + TRM Adapter

Break Out Box Adapter for fault tracing on Power Operated Tailgate and Trailer Module.

<b>Tool standard</b>	C2
<b>Tool group</b>	39
<b>Tool bulletin</b>	383
<b>Model</b>	XC90 (16-)
<b>Tool board</b>	Electrical cabinet
<b>Price</b>	

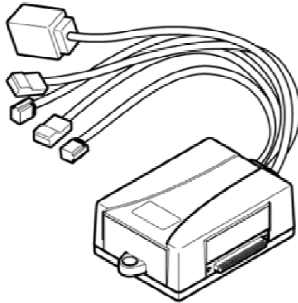

## 9513080 CCM Adapter

Break out box Adapter for fault tracing the Climate Control Module.

<b>Tool standard</b>	C2
<b>Tool group</b>	39
<b>Tool bulletin</b>	383
<b>Model</b>	XC90 (16-)
<b>Tool board</b>	Electrical cabinet
<b>Price</b>	

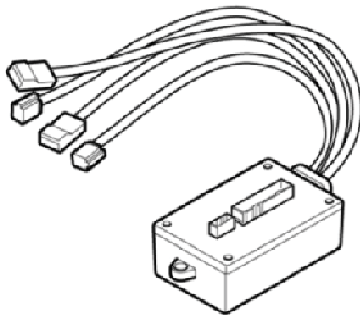

## 9513081 SPM Adapter

Break Out Box Adapter for fault tracing Software Plug-in Module.

<b>Tool standard</b>	C2
<b>Tool group</b>	39
<b>Tool bulletin</b>	383
<b>Model</b>	XC90 (16-)
<b>Tool board</b>	Electrical cabinet
<b>Price</b>	

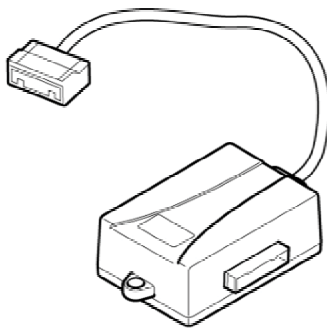

## 9513086 TACM Adapter

Break Out Box Adapter for fault tracing Transmission Actuator Control Module.

<b>Tool standard</b>	C2
<b>Tool group</b>	39
<b>Tool bulletin</b>	383
<b>Model</b>	XC90 (16-)
<b>Tool board</b>	Electrical cabinet
<b>Price</b>	

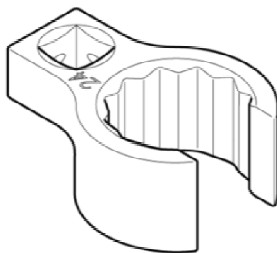

## 9814207 Crow Foot

The tool is used to disassemble and assemble the AC pressure sensor.

<b>Tool standard</b>	C1
<b>Tool group</b>	87
<b>Tool bulletin</b>	382
<b>Model</b>	XC90 (16-)
<b>Tool board</b>	87
<b>Price</b>	

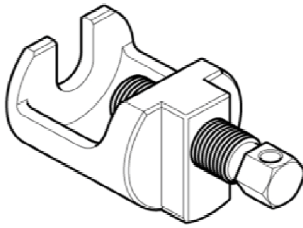

## 9997515 Puller

Puller used for removing wiper arm.

<b>Tool standard</b>	C1
<b>Tool group</b>	36
<b>Tool bulletin</b>	382
<b>Model</b>	XC90 (16-)
<b>Tool board</b>	36
<b>Price</b>	

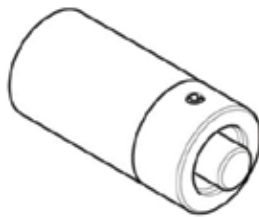

## 9997518 Adapter

Use puller rod from M10 to M8.

<b>Tool standard</b>	C1
<b>Tool group</b>	87
<b>Tool bulletin</b>	382
<b>Model</b>	XC90 (16-)
<b>Tool board</b>	87
<b>Price</b>	

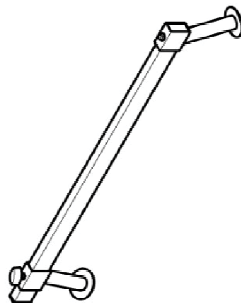

## 9997523 Engine Support Bar

This tool used to lift the engine during the service.  
New lifting clamp is needed for the XC90 platform.

<b>Tool standard</b>	C1
<b>Tool group</b>	21
<b>Tool bulletin</b>	382
<b>Model</b>	XC90 (16-)
<b>Tool board</b>	21
<b>Price</b>	

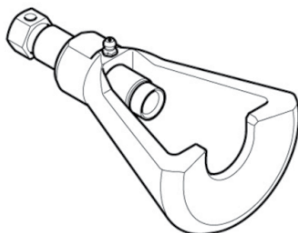

## 9997524 Extractor

This tool used to removing outer steering joint.

<b>Tool standard</b>	C2
<b>Tool group</b>	64
<b>Tool bulletin</b>	382
<b>Model</b>	XC90 (16-)
<b>Tool board</b>	64
<b>Price</b>	



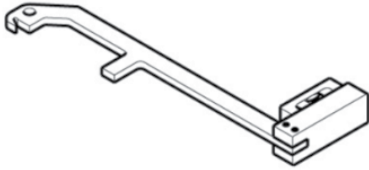

## 9997529 Positioner

The tool used to position the PAC (Parking Assistance Camera) during calibration.

<b>Tool standard</b>	C1
<b>Tool group</b>	36
<b>Tool bulletin</b>	382
<b>Model</b>	XC90 (16-)
<b>Tool board</b>	36
<b>Price</b>	

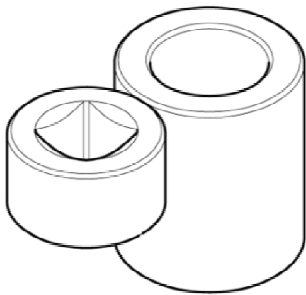

## 9997531 Sleeve

The tool use for removing the rear shock absorber upper storage.

<b>Tool standard</b>	C1
<b>Tool group</b>	76
<b>Tool bulletin</b>	382
<b>Model</b>	XC90 (16-)
<b>Tool board</b>	76
<b>Price</b>	

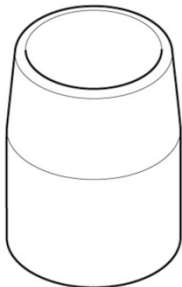

## 9997532 Sleeve

Used to protect the sealing ring from damage during mounting sealing ring.

<b>Tool standard</b>	C1
<b>Tool group</b>	21
<b>Tool bulletin</b>	382
<b>Model</b>	XC90 (16-)
<b>Tool board</b>	21
<b>Price</b>	

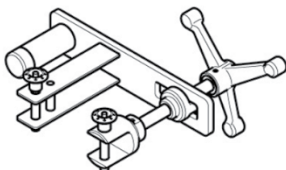

## 9997533 Support

Engine Support hold the engine from below during work.

<b>Tool standard</b>	C2
<b>Tool group</b>	21
<b>Tool bulletin</b>	382
<b>Model</b>	XC90 (16-)
<b>Tool board</b>	21
<b>Price</b>	



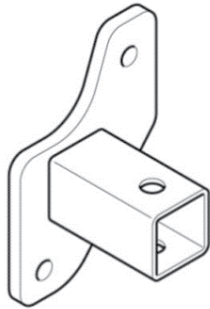

## 9997534 Attachment

Attached to the engine support, working together with Support 9997533.

<b>Tool standard</b>	C1
<b>Tool group</b>	21
<b>Tool bulletin</b>	382
<b>Model</b>	XC90 (16-)
<b>Tool board</b>	21
<b>Price</b>	

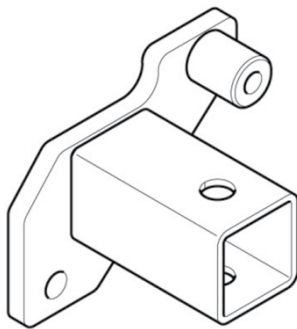

## 9997535 Attachment

Attached to the engine support, used together with Support 9997533.

<b>Tool standard</b>	C1
<b>Tool group</b>	21
<b>Tool bulletin</b>	382
<b>Model</b>	XC90 (16-)
<b>Tool board</b>	21
<b>Price</b>	

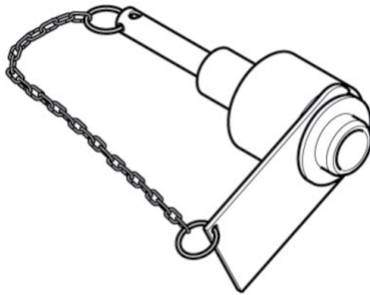

## 9997536 Guide Pin

Adjustment tool for correct sub frame position.

<b>Tool standard</b>	C1
<b>Tool group</b>	21
<b>Tool bulletin</b>	382
<b>Model</b>	XC90 (16-)
<b>Tool board</b>	21
<b>Price</b>	

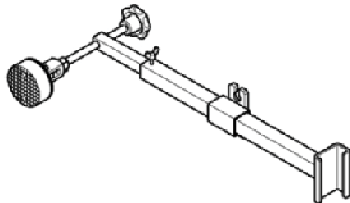

## 9997537 Support Bar

The tool is use to support the engine, working together with Support 9997533.

<b>Tool standard</b>	C1
<b>Tool group</b>	21
<b>Tool bulletin</b>	382
<b>Model</b>	XC90 (16-)
<b>Tool board</b>	21
<b>Price</b>	

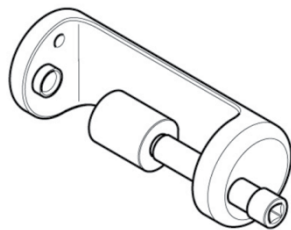

## 9997538 Extractor

This tool use to dismount rear link arm bushings.

<b>Tool standard</b>	C1
<b>Tool group</b>	61
<b>Tool bulletin</b>	382
<b>Model</b>	XC90 (16-)
<b>Tool board</b>	61
<b>Price</b>	

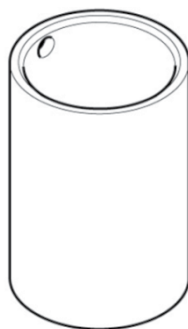

## 9997539 Counterhold

The tool used to dismount bushings rear linkarm.

<b>Tool standard</b>	C1
<b>Tool group</b>	65
<b>Tool bulletin</b>	382
<b>Model</b>	XC90 (16-)
<b>Tool board</b>	65
<b>Price</b>	



## 9997540 Drift

Drift use for mounting bushings rear linkarm.

<b>Tool standard</b>	C1
<b>Tool group</b>	65
<b>Tool bulletin</b>	382
<b>Model</b>	XC90 (16-)
<b>Tool board</b>	65
<b>Price</b>	



## 9997541 Drift

Drift use for mounting bushing rear linkarm.

<b>Tool standard</b>	C1
<b>Tool group</b>	65
<b>Tool bulletin</b>	382
<b>Model</b>	XC90 (16-)
<b>Tool board</b>	65
<b>Price</b>	

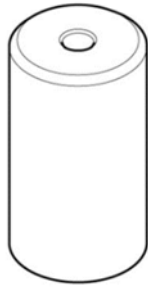

## 9997542 Counterhold

Counterholduse for demounting bushing rear linkarm.

**Tool standard** C1  
**Tool group** 65  
**Tool bulletin** 382  
**Model** XC90 (16-)  
**Tool board** 65  
**Price**



## 9997543 Drift

Drift use for mounting bushing rear linkarm.

**Tool standard** C1  
**Tool group** 65  
**Tool bulletin** 382  
**Model** XC90 (16-)  
**Tool board** 65  
**Price**

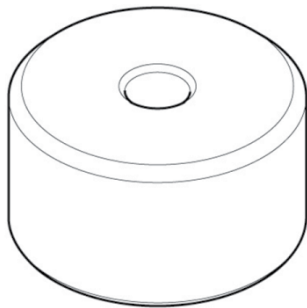

## 9997544 Drift

Drift use for mounting bushing rear linkarm.

**Tool standard** C1  
**Tool group** 65  
**Tool bulletin** 382  
**Model** XC90 (16-)  
**Tool board** 65  
**Price**



## 9997545 Counterhold

Counterhold use for demounting bushings rear linkarm.

**Tool standard** C1  
**Tool group** 65  
**Tool bulletin** 382  
**Model** XC90 (16-)  
**Tool board** 65  
**Price**

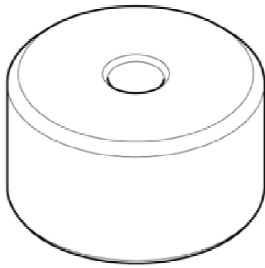

## 9997546 Drift

This tool use for mounting bushings rear linkarm.

<b>Tool standard</b>	C1
<b>Tool group</b>	65
<b>Tool bulletin</b>	382
<b>Model</b>	XC90 (16-)
<b>Tool board</b>	65
<b>Price</b>	

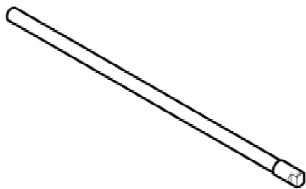

## 9997550 Pulling Rod M14/M16

Use to dismount and mount of bushings.

<b>Tool standard</b>	C1
<b>Tool group</b>	65
<b>Tool bulletin</b>	382
<b>Model</b>	XC90 (16-)
<b>Tool board</b>	65
<b>Price</b>	

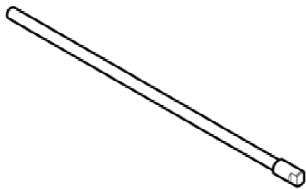

## 9997551 Pulling Rod M12/M16

Use to dismount and mount of bushings.

<b>Tool standard</b>	C1
<b>Tool group</b>	65
<b>Tool bulletin</b>	382
<b>Model</b>	XC90 (16-)
<b>Tool board</b>	65
<b>Price</b>	



## 9997552 Counterhold

Counterhold use for demounting bushings rear linkarm.

<b>Tool standard</b>	C1
<b>Tool group</b>	21
<b>Tool bulletin</b>	382
<b>Model</b>	XC90 (16-)
<b>Tool board</b>	21
<b>Price</b>	

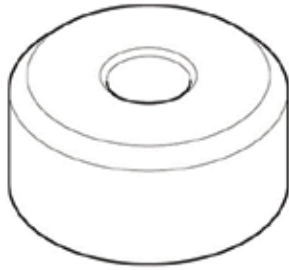

## 9997553 Drift

This tool use for mounting bushings rear linkarm.

<b>Tool standard</b>	C1
<b>Tool group</b>	21
<b>Tool bulletin</b>	382
<b>Model</b>	XC90 (16-)
<b>Tool board</b>	21
<b>Price</b>	

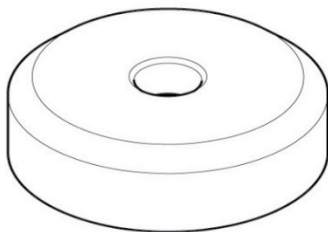

## 9997554 Drift

This tool used to press out the old bushing and push in the new one.

<b>Tool standard</b>	C1
<b>Tool group</b>	21
<b>Tool bulletin</b>	382
<b>Model</b>	XC90 (16-)
<b>Tool board</b>	21
<b>Price</b>	

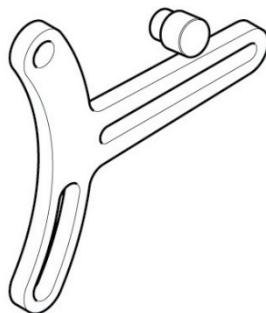

## 9989885 Update Kit

NOTE: The mounting tool marked 9997555 has been modified to be used on the XC90 (16-), S90 (17-), S90L, V90 (17-) and V90 Cross Country vehicles. This tool is now referenced as 9989885. Complete measuring kit is 9995418.

<b>Tool standard</b>	C1
<b>Tool group</b>	51
<b>Tool bulletin</b>	382
<b>Model</b>	XC90 (16-)
<b>Tool board</b>	51
<b>Price</b>	

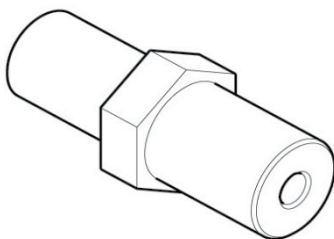

## 9997549 Adapter

Adapter for M14 to M16 use turn of 10 tons or pull-cylinder.

<b>Tool standard</b>	C1
<b>Tool group</b>	65
<b>Tool bulletin</b>	382
<b>Model</b>	XC90 (16-)
<b>Tool board</b>	65
<b>Price</b>	