

Driveline Vibration Under Deceleration Around 10 - 30 MPH

Service Category Drivetrain

Section Drive Shaft/Propeller Shaft

Market USA

Toyota Supports
 ASE Certification 

Applicability

YEAR(S)	MODEL(S)	ADDITIONAL INFORMATION
2016 - 2017	Tacoma	VDS(s): CZ5AN, GZ5AN, SZ5AN Engine(s): 2GR Drive Type(s): 4WD Transmission(s): 6AT

REVISION NOTICE

September 1, 2017 Rev1:

- **Applicability has been updated to include 2017 model year Tacoma vehicles.**
- **The Introduction, Production Change Information, and Repair Procedure sections have been updated.**

Any previous printed versions of this bulletin should be discarded.

Introduction

Some 2016 – 2017 model year Tacoma vehicles equipped with an automatic transmission may exhibit a vibration felt in the seat, floorboard, and/or steering wheel between 10 – 30 mph caused by a driveline vibration under deceleration. Follow the steps in this bulletin to address this condition.

NOTE

This Service Bulletin ONLY applies to 4WD models equipped with 6AT. Do NOT use the spring part number found in the Service Bulletin for any manual transmission vehicles or PreRunner models. This could lead to NEW, non-existing issues. If the vehicle has an aftermarket suspension/body lift or leveling kit installed, this bulletin does NOT apply.

Driveline Vibration Under Deceleration Around 10 - 30 MPH

Production Change Information

- This bulletin applies to ALL 2016 – 2017 model year Tacoma vehicles NOT equipped with the TRD Off-Road package option.
- This Bulletin also applies to 2016 model year Tacoma vehicles equipped with the TRD Off-Road package option produced BEFORE the Production Change Effective VINs.

CAB TYPE	PRODUCTION CHANGE EFFECTIVE VIN
Double	5TFGZ5AN#GX040536
	3TMGZ5AN#GM039554
	5TFCZ5AN#GX040121
	3TMCZ5AN#GM039538
Access	5TFSZ5AN#GX017523

NOTE

ALL TRD Off-Road package vehicles produced AFTER the effective VIN change use the same springs in production as the countermeasure part numbers listed in this Service Bulletin. Do NOT follow this Service Bulletin for TRD Off-Road equipped vehicles produced AFTER production change effective VIN's provided in the Production Change Information Table.

Warranty Information

OP CODE	DESCRIPTION	TIME	OFF	T1	T2
SU1605	Measure Joint Angle and R & R Leaf Springs	1.7	48210-04700 48210-04810 48210-04710 48220-04340 48220-04450 48220-04350	9B	57
SU1605A	Install Steering Wheel Damper	0.6	45713-35050 45713-60030		

APPLICABLE WARRANTY

- This repair is covered under the Toyota Basic Warranty. This warranty is in effect for 36 months or 36,000 miles, whichever occurs first, from the vehicle's in-service date.
- Warranty application is limited to occurrence of the specified condition described in this bulletin.

Driveline Vibration Under Deceleration Around 10 - 30 MPH

Parts Information

CAB TYPE	PART NUMBER		PART NAME	QTY
	PREVIOUS	NEW		
Double	48210-04700 48210-04810 48210-04710	48210-04840	Spring Assy, RR RH	1
	48220-04340 48220-04450 48220-04350	48220-04480	Spring Assy, RR LH	1
	48210-04700 48210-04810 48210-04710	48210-04830	Spring Assy, RR RH	1
Access	48220-04340 48220-04450 48220-04350	48220-04470	Spring Assy, RR LH	1
	45713-35040		Damper, Steering Shake	1

Required Tools & Equipment

REQUIRED TOOLS & MATERIAL	PART NUMBER	QTY
Digital Angle Gauge	01815-00102	1

NOTE

Additional SSTs may be ordered by calling 1-800-933-8335.

Repair Procedure

- Some level of driveline vibration is normal in ALL vehicles. However, if the vehicle exhibits a vibration under the following conditions, continue to step 2.
 - Coast down or during braking
 - Speeds between 10 – 30 mph

NOTE

The following method can be used to confirm if this bulletin applies to the vehicle:

- Remove the rear driveshaft.
- Shift into 4WD HI.
- Test drive the vehicle.

If there is a vibration outside of the conditions above, this bulletin does NOT apply. Continue diagnosis using the applicable Repair Manual.

Driveline Vibration Under Deceleration Around 10 - 30 MPH

Repair Procedure (Continued)

2. Remove the steering wheel pad.

CAUTION

Wait at **LEAST 90 seconds AFTER** disconnecting the cable from the negative (-) battery terminal to disable the SRS system.

Refer to the Technical Information System (TIS), applicable model and model year Repair Manual:

- 2016 – 2017 Tacoma:
Vehicle Interior – Supplemental Restraint Systems – “Supplemental Restraint Systems: Steering Pad: [Removal](#)”

3. Remove the steering wheel switch wire harness retainer bracket (ONLY for vehicles with steering wheel mounted switches).

Figure 1.

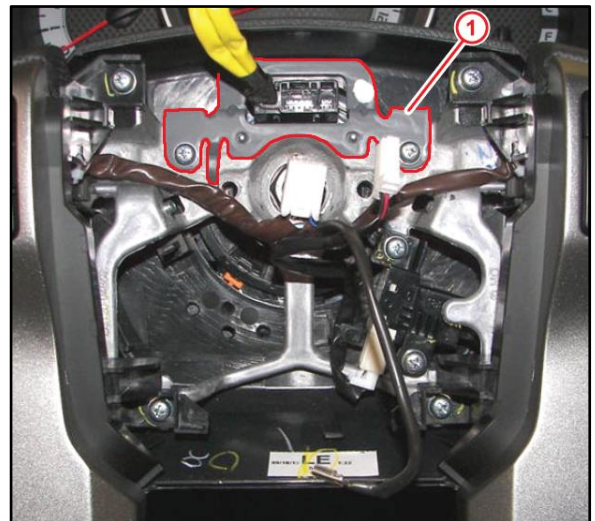

1	Steering Wheel Switch Wire Harness Retainer Bracket
----------	--

Driveline Vibration Under Deceleration Around 10 - 30 MPH

Repair Procedure (Continued)

4. Install the steering wheel damper with two NEW screws in the locations shown.
Torque: 2.35 N*m (24 kgf*cm, 20.8 in*lb)

NOTICE
When disconnecting ANY airbag connector, take care not to damage the airbag wire harness.

NOTE
Secure the steering wheel switch wires to the steering wheel damper bracket hooks as shown.

Figure 2.

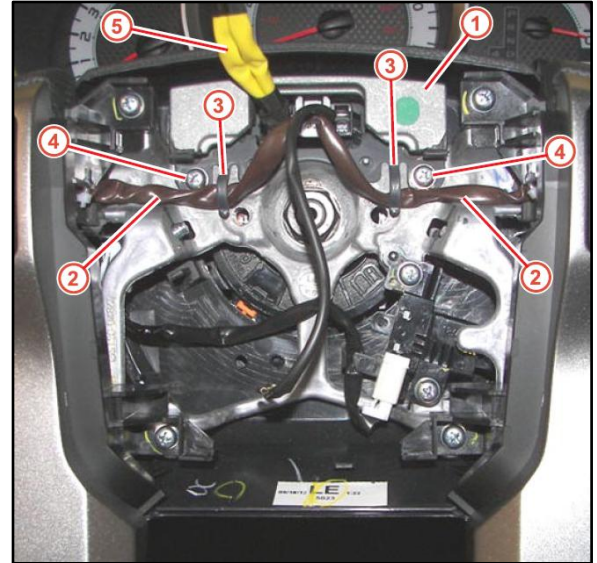

1	Damper
2	Steering Wheel Switch Wire Harness
3	Damper Bracket Wire Retainer Hooks
4	Screw
5	Driver Side Airbag Wire Harness

5. Install the steering wheel pad.
Refer to TIS, applicable model and model year Repair Manual:
 - 2016 – 2017 Tacoma:
Vehicle Interior – Supplemental Restraint Systems – “Supplemental Restraint Systems: Steering Pad: [Installation](#)”
6. Raise the vehicle using a drive-on hoist or wheel alignment rack.

NOTE
Suspension of vehicle **MUST** be at ride height.

Driveline Vibration Under Deceleration Around 10 - 30 MPH

Repair Procedure (Continued)

7. Verify which flange type the vehicle is equipped with:

- Large flange (Figure 3) – Continue to step 8.
- Small flange (Figure 4) – Go to step 9.

Figure 3.

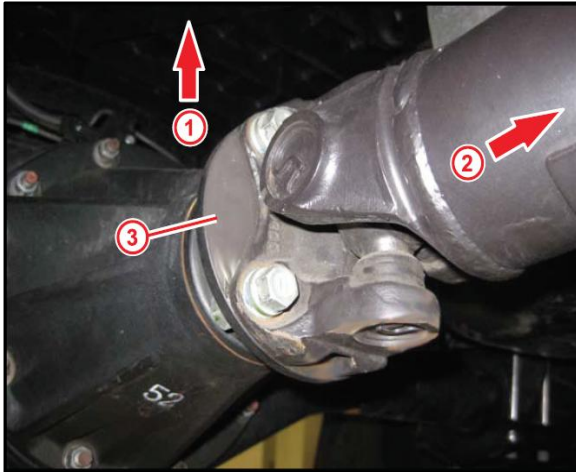

1	Up
2	Front
3	Pinion Flange

Figure 4.

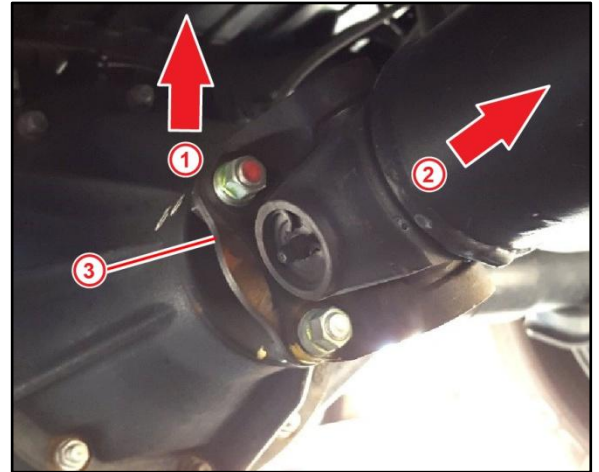

1	Up
2	Front
3	Pinion Flange

Driveline Vibration Under Deceleration Around 10 - 30 MPH

Repair Procedure (Continued)

8. Measure the Pinion Flange Angle (F/A) – Large Flange Type.

NOTE

Be sure to wipe off the area before taking pinion flange measurement.

- A. Place the protractor against the flange surface.

- (1) Ensure the protractor is firmly against the flange to obtain an accurate Pinion Flange Angle as shown in Figure 5.

Figure 5.



Figure 6.

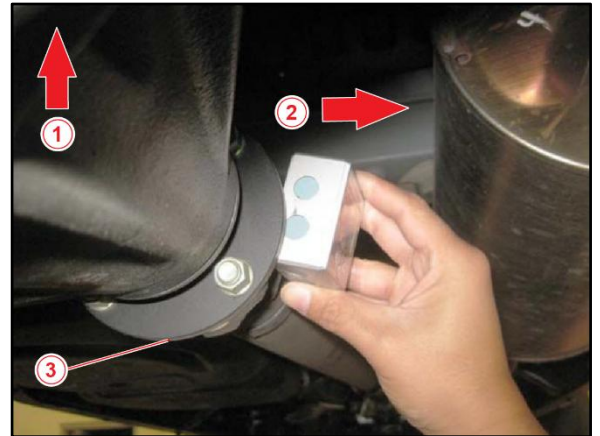

1	Up
2	Passenger Side of Vehicle
3	Pinion Flange

- (2) Record the Pinion Flange Angle (F/A).

Figure 7.



Driveline Vibration Under Deceleration Around 10 - 30 MPH

Repair Procedure (Continued)

9. Measure the Pinion Flange Angle (F/A) – **Small Flange Type.**

A. Remove the propeller shaft.

Refer to TIS, applicable model and model year Repair Manual:

- 2016 – 2017 Tacoma:

Engine/Hybrid System – Propeller Shaft – “Propeller Shaft: Propeller Shaft Assembly (for 4WD) – [Removal](#)”

B. Place the protractor against the flange surface.

Ensure the protractor is firmly against the flange to obtain an accurate Pinion Flange Angle as shown.

Figure 8.

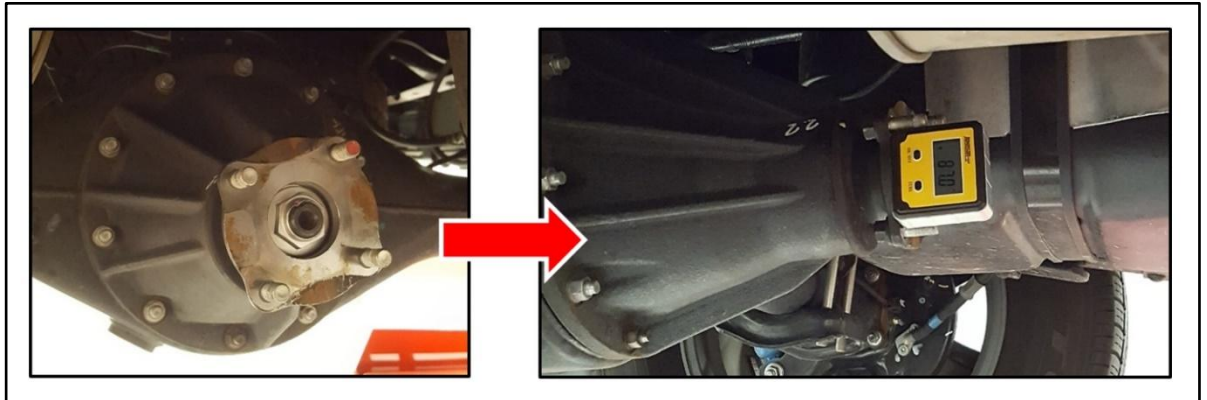

Driveline Vibration Under Deceleration Around 10 - 30 MPH

Repair Procedure (Continued)

10. Measure propeller shaft to Pinion Joint Angle (J/A).

NOTE

ALL measurements MUST be taken from the passenger side of vehicle facing the driver side. Refer to Figure 9 to ensure that the angles measured have the correct positive (+) or negative (-) values assigned.

- Arrow pointing up indicates a positive (+) angle. In the example on the left, the angle measured is a positive 1.15 (+1.15).
- Arrow pointing down indicates a negative (-) angle. In the example on the right, the angle measured is a negative 0.95 (-0.95).

Figure 9.

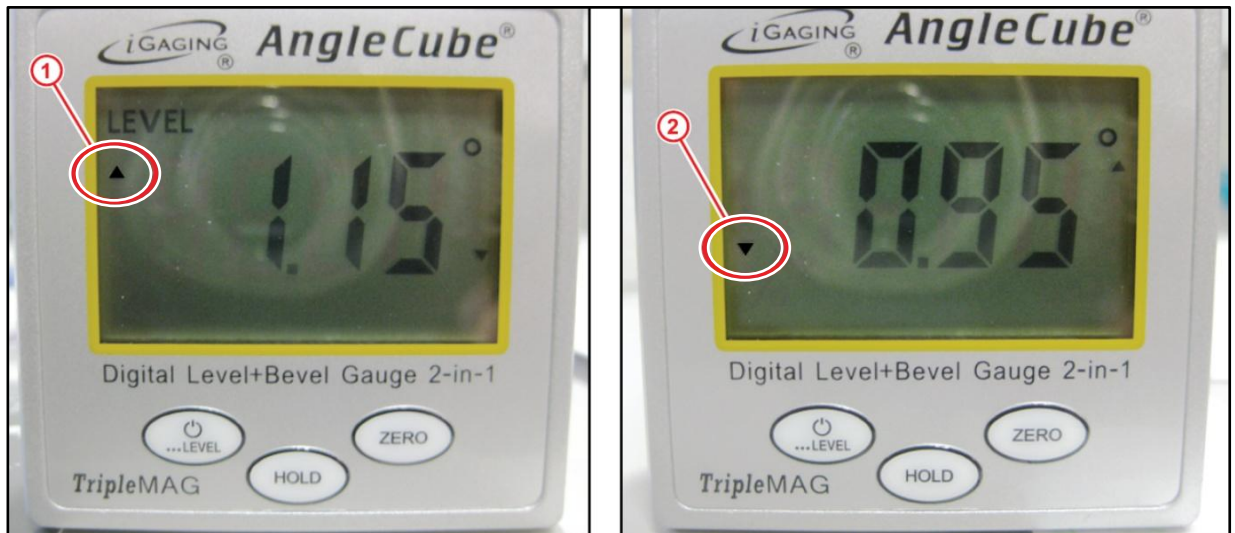

1	Up Arrow (Positive)
---	---------------------

2	Down Arrow (Negative)
---	-----------------------

11. Measure the Propeller Shaft Angle (P/A).
 - A. Rotate pinion flange (as shown in Figure 10) to the correct position (as shown in Figure 11).

Figure 10.

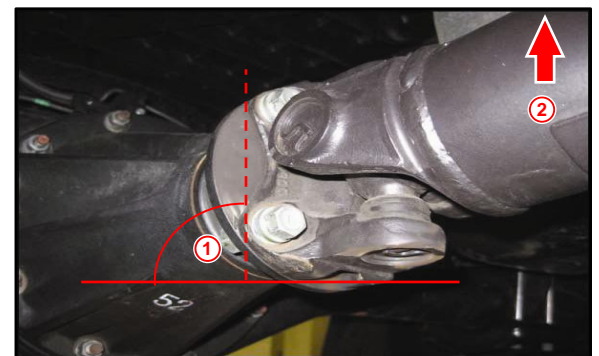

1	90°
2	Up

Driveline Vibration Under Deceleration Around 10 - 30 MPH

Repair Procedure (Continued)

- B. Use the protractor and measure the angle of the rear section of the two-piece propeller shaft. Ensure the protractor is placed along the centerline of the propeller shaft as shown in Figure 11.

Figure 11. CORRECT Placement of Protractor



Figure 12. INCORRECT Placement of Protractor



Figure 13.

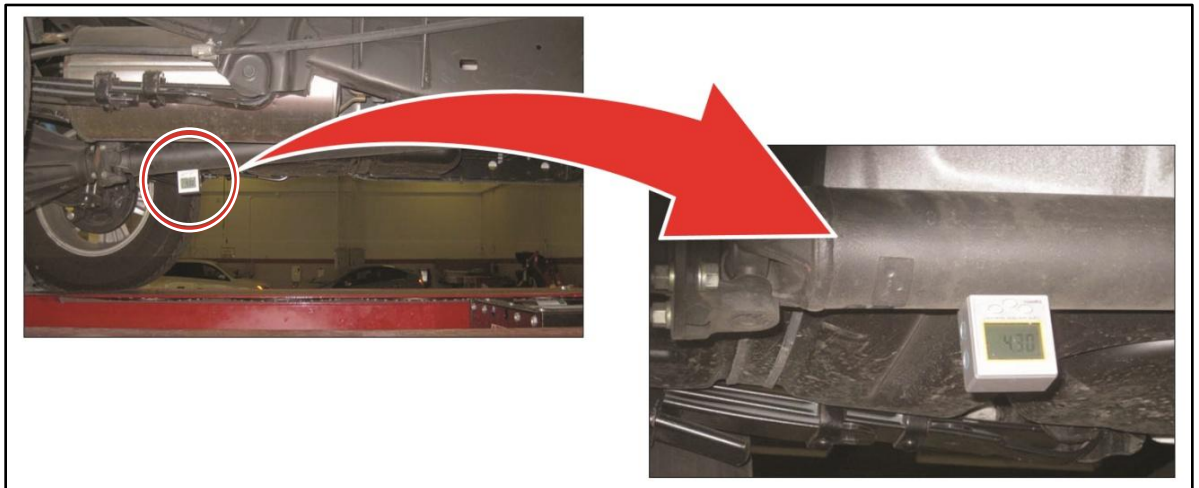

- C. Record the Propeller Shaft Angle (P/A).

Table 1. Joint Angle Worksheet (Pinion Flange Angle Minus Propeller Shaft Angle = Joint Angle)

PINION FLANGE ANGLE	-	PROPELLER SHAFT ANGLE	=	JOINT ANGLE
F/A	-	P/A	=	J/A
	-		=	

NOTE

Joint Angle (J/A) can be a negative (-) value.

Driveline Vibration Under Deceleration Around 10 - 30 MPH

Repair Procedure (Continued)

12. Verify if the vehicle is equipped with standard or firm ride suspension. Look up the factory option codes (accessories) in vehicle history on TIS.

Does the vehicle have option codes **CW, OF, OC, PT, or PY**?

- **YES** — The vehicle has firm ride suspension.
- **NO** — The vehicle has standard suspension.

13. Verify the vehicle's model code (**Katashiki**).

The model code can be found on the Vehicle Identification Label in the driver door jamb as shown.

Figure 14.

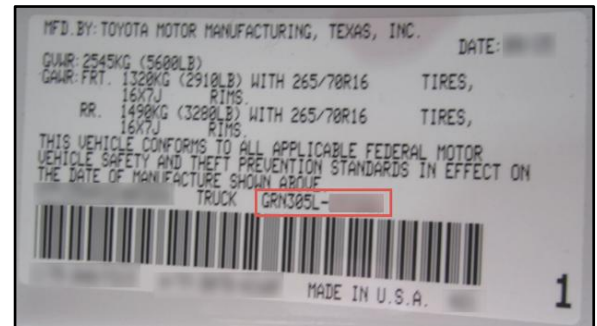

14. After the joint angle, the spring type, and the model code have been verified, refer to the table below to determine if the joint angle is in specification:

- **YES** — This bulletin does NOT apply. Continue diagnosis using the applicable Repair Manual.
- **NO** — Continue to step 15.

Table 2.

MODEL CODE	CAB TYPE	GRADE	TYPE	JOINT ANGLE RANGE SPECIFICATION
GRN305L-PRTLHA	Double	Limited	Firm	+1.41° to +3.41°
			Standard	+1.38° to +3.38°
GRN305L-PRTSHA	Double	Any	Firm	+1.41° to +3.41°
			Standard	+1.38° to +3.38°
GRN305L-CRTSHA	Access	NOT Off-Road Package	Firm	+1.7° to +3.7°
		Off Road Package	Standard	-0.6° to +1.4°
		NOT Off-Road Package		+1.67° to +3.67°

Driveline Vibration Under Deceleration Around 10 - 30 MPH

Repair Procedure (Continued)

15. Replace the leaf spring using the part information in the following table:

Table 3.

MODEL CODE	CAB TYPE	GRADE	LH PART NUMBER	RH PART NUMBER
GRN305L-PRTLHA	Double	Limited	48220-04480	48210-04840
GRN305L-PRTSHA		Any		
GRN305L-CRTSHA	Access	NOT Off-Road Package	48220-04470	48210-04830
		Off-Road Package		
		NOT Off-Road Package		

NOTE

When tightening the U-bolt nuts, be sure to set to the following torque:
 Torque: 60 N*m (610 kgf*cm, 44 ft*lbf)

Refer to TIS, applicable model and model year Repair Manual:

- 2016 – 2017 Tacoma:
Suspension – Rear Suspension – “Suspension: Rear Leaf Spring: [Removal / Installation](#)”

Figure 15.

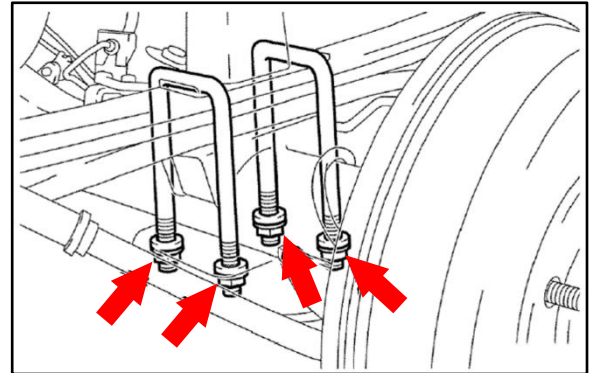

NOTE

Fasteners for shocks and leaf spring bushings should be tightened. Then, torque for these joints should be set while the vehicle is on the ground.

16. Test drive the vehicle between 15 – 25 mph and confirm the level of vibration has improved under deceleration or acceleration.