



SERVICE BULLETIN

Classification: RS17-021a	Reference: NTB17-033a	Date: August 10, 2017
------------------------------	--------------------------	--------------------------

2016 MAXIMA; OCCUPANT CLASSIFICATION SYSTEM RETROFIT

This bulletin has been amended. The CLAIMS INFORMATION section has been revised. No other changes have been made. Please discard all previous versions of this bulletin.

APPLIED VEHICLE: 2016 Maxima (A36)

SERVICE INFORMATION

The information in this bulletin is provided for customers who have concerns with their vehicle's Occupant Classification System (OCS) operation after all campaigns have been completed.

Follow the steps in this bulletin to determine if this OCS retrofit procedure is applicable to the vehicle you are working on.

DETERMINE IF OCS RETROFIT APPLIES

1. Check Service COMM to confirm if the OCS reprogramming campaign has been completed (R1609 / NTB16-052).

Completed:

- Write on the repair order the date it was completed and by which dealer.
- Go to step 2.

Not Completed:

- Complete campaign R1609 / NTB16-052.
- No further action needed. OCS retrofit does NOT apply.

Nissan Bulletins are intended for use by qualified technicians, not 'do-it-yourselfers'. Qualified technicians are properly trained individuals who have the equipment, tools, safety instruction, and know-how to do a job properly and safely. **NOTE:** If you believe that a described condition may apply to a particular vehicle, DO NOT assume that it does. See your Nissan dealer to determine if this applies to your vehicle.

2. Verify and document the customer's concern (have the customer demonstrate the concern).
3. Using CONSULT-III plus, check for Air bag or OCS related DTCs.

No Air bag or OCS DTCs: go to step 4.

Air bag or OCS DTCs stored:

- Refer to the Electronic Service Manual (ESM), section **SRC – SRS Air bag Control System**, for diagnostic and repair information.
 - OCS retrofit does NOT apply.
4. If all of the following are confirmed:
 - Campaign R1609 / NTB16-052 has been completed.
 - Customer concern has been confirmed and documented.
 - No air bag or OCS DTCs are stored.

Then

5. Replace the front passenger seat frame and seat belt buckle (mounted to the seat).
 - Go to **SERVICE PROCEDURE** on page 3.
 - See **PARTS INFORMATION**.
6. Perform Zero Point Reset, using CONSULT-III plus.
 - Refer to page 12.

SERVICE PROCEDURE

Front Passenger Seat: Removal

WARNING: This procedure involves working under the front passenger seat. The metal seat frame has sharp edges.

CAUTION: Handle interior trim carefully to avoid damage. Work with clean hands and clean tools to avoid dirt and stains. Use protective covers as needed.

IMPORTANT: Follow all cautions, warnings, and notes in the Electronic Service Manual (ESM) when working on or near a Supplemental Restraint System (SRS), such as an air bag or OCS components.

1. Turn the ignition ON, engine OFF.
2. Write down the radio settings.

Presets	1	2	3	4	5	6
AM						
FM 1						
FM 2						
SAT 1						
SAT 2						
SAT 3						
Bass	Treble		Balance	Fade	Spd Sen. Vol.	

3. Record (write down) any other customer settings that will be lost when the battery is disconnected.
 - Refer to the Electronic Service Manual (ESM) section **PG-Power Supply, Ground, & Circuit Elements**, for a listing of systems that may lose settings or memory when disconnecting the 12V battery.
 - Look in the **PG** section index for **ADDITIONAL SERVICE WHEN REMOVING BATTERY NEGATIVE TERMINAL**.
 - This list often includes items such as audio, HVAC, power windows, clock, etc.

4. Turn the ignition OFF.
5. Carefully remove the front passenger seat.
 - Refer to the ESM, section **SE-Seat**, for front passenger seat removal.
 - The power seat may need forward/backward movement to access the mounting bolts. Follow the ESM for battery connection/disconnection.
 - Each time the battery is disconnected, wait at least three (3) minutes before continuing.
6. Set the seat in a clean working area.

Seat Frame Assembly and Seat Belt Buckle: Replacement

1. Replace the seat frame assembly and seat belt buckle.
 - See **PARTS INFORMATION**.
 - Refer to the ESM, section **SE-Seat** and **SB-Seat Belt**, for front passenger seat frame assembly and seat belt buckle replacement.

NOTE: The side air bag electrical harness is not fastened on the new seat frame assembly. It is part of the new seat frame assembly, but must be fastened before installing the seat.

- Side air bag electrical harness routing: Go to pages 6 and 7.

WARNING: The side air bag electrical harness **must** be routed and fastened as shown on pages 6 and 7.

- Transfer the existing seat cushion assembly to the new seat frame assembly in reverse order of removal.
 - Heated seats: Make sure to route the seat cushion heater unit electrical harness as shown on pages 8, 9, and 10.
- For seat belt buckle installation: Go to page 11.

Front Passenger Seat: Installation

1. Install the front passenger seat in reverse order of removal.
 - Refer to the ESM, section **SE-Seat**, for front passenger seat installation.
 - The power seat may need forward/backward movement to access the mounting bolts. Follow the ESM for battery connection/disconnection.
 - Each time the battery is disconnected, wait at least three (3) minutes before continuing.
 - Install a new clip for the body harness (on page 6, see **1** in Figure 2).
 - See **PARTS INFORMATION** for the clip's part number.

- Seat mounting bolts torque:
49 N•m (5.0 kg-m, **36 ft lbs**)
- Torque the bolts in the sequence shown in Figure 1.

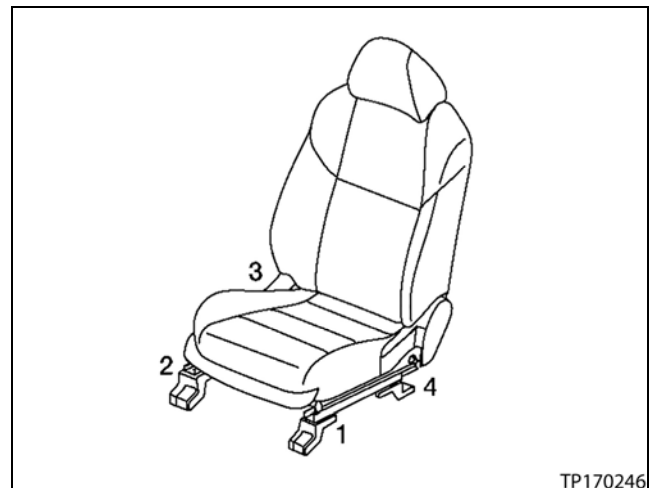

Figure 1

2. If the battery cables were not connected as part of the seat installation, reconnect them now, positive cable first.
3. Reset/reinitialize systems as needed.
 - Refer to the ESM, section **PG-Power, Supply & Ground Elements**, for a listing of systems that require reset/initialization after reconnecting the 12V battery.
 - Look in the **PG** section index for **ADDITIONAL SERVICE WHEN REMOVING BATTERY NEGATIVE TERMINAL**.
 - This list often includes items such as audio, power windows, clock, etc.
4. Perform Zero Point Reset using CONSULT-III plus.
 - Go to page 12.

All Front Passenger Seats: Side Air Bag Electrical Harness Routing

- Climate controlled seat shown. Heated and non-heated seats similar.

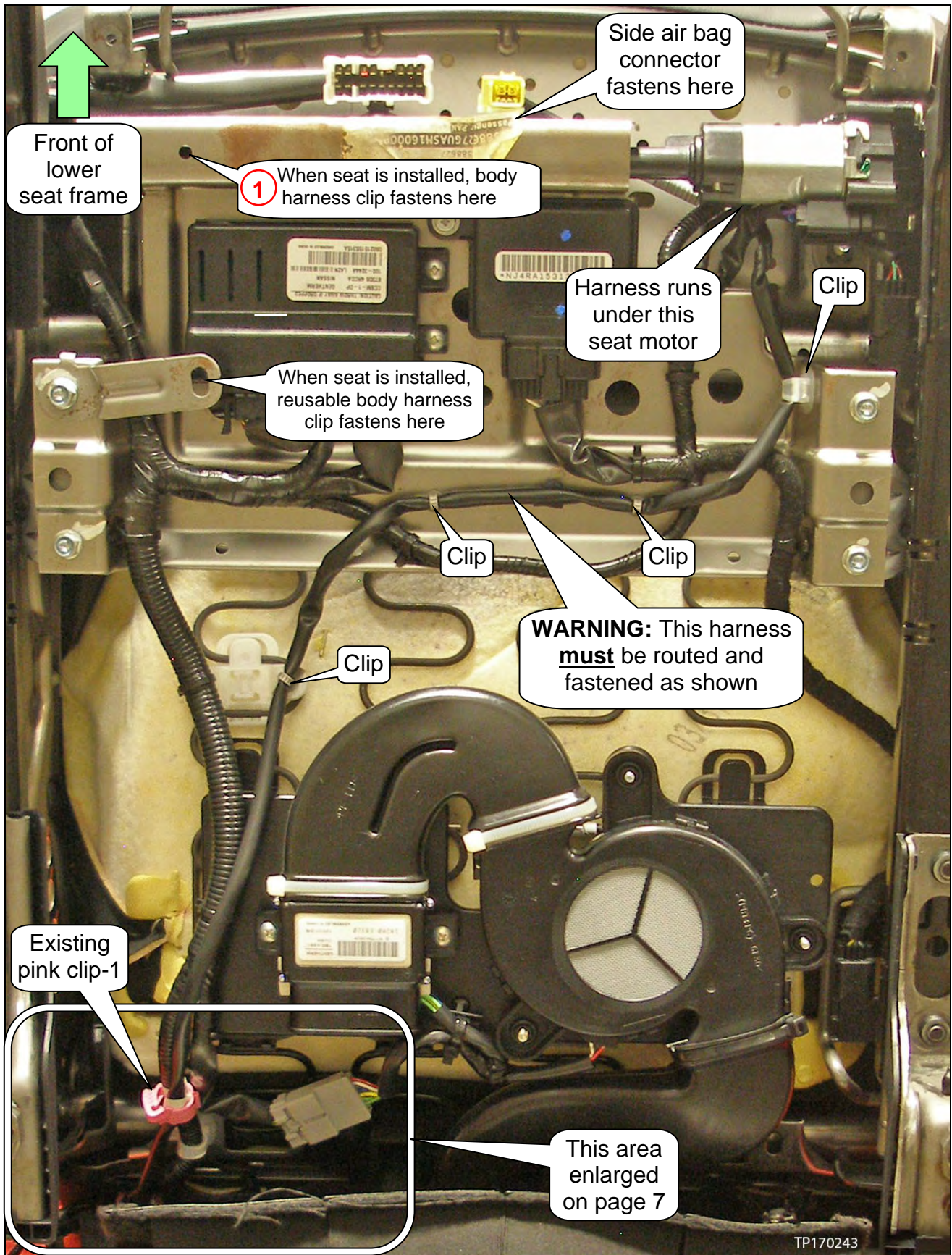

Figure 2

All Front Passenger Seat Frames: Side Air Bag Electrical Harness Routing (continued)

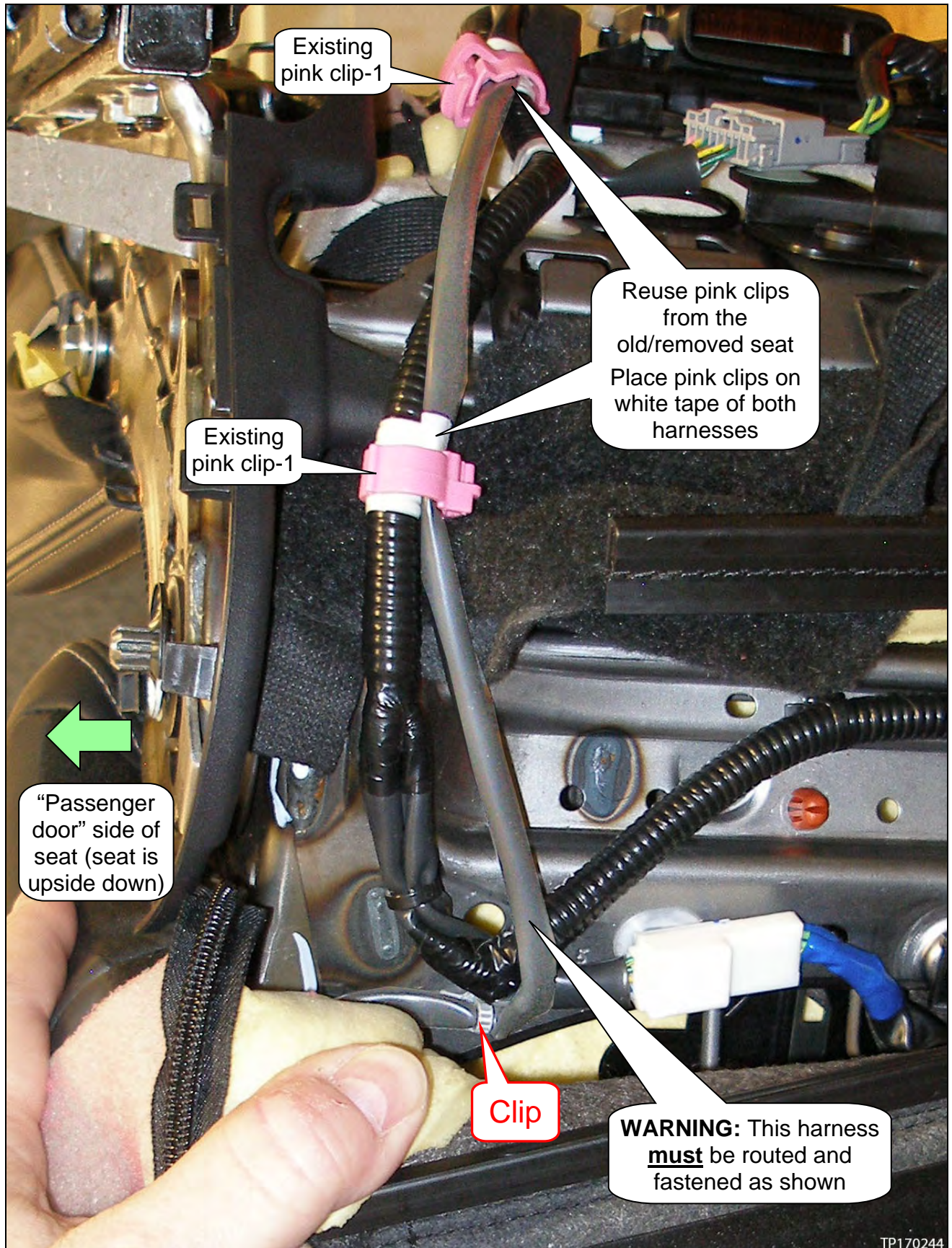

Figure 3

Heated Seats Only

Seat Cushion Heater Electrical Connector: Removal

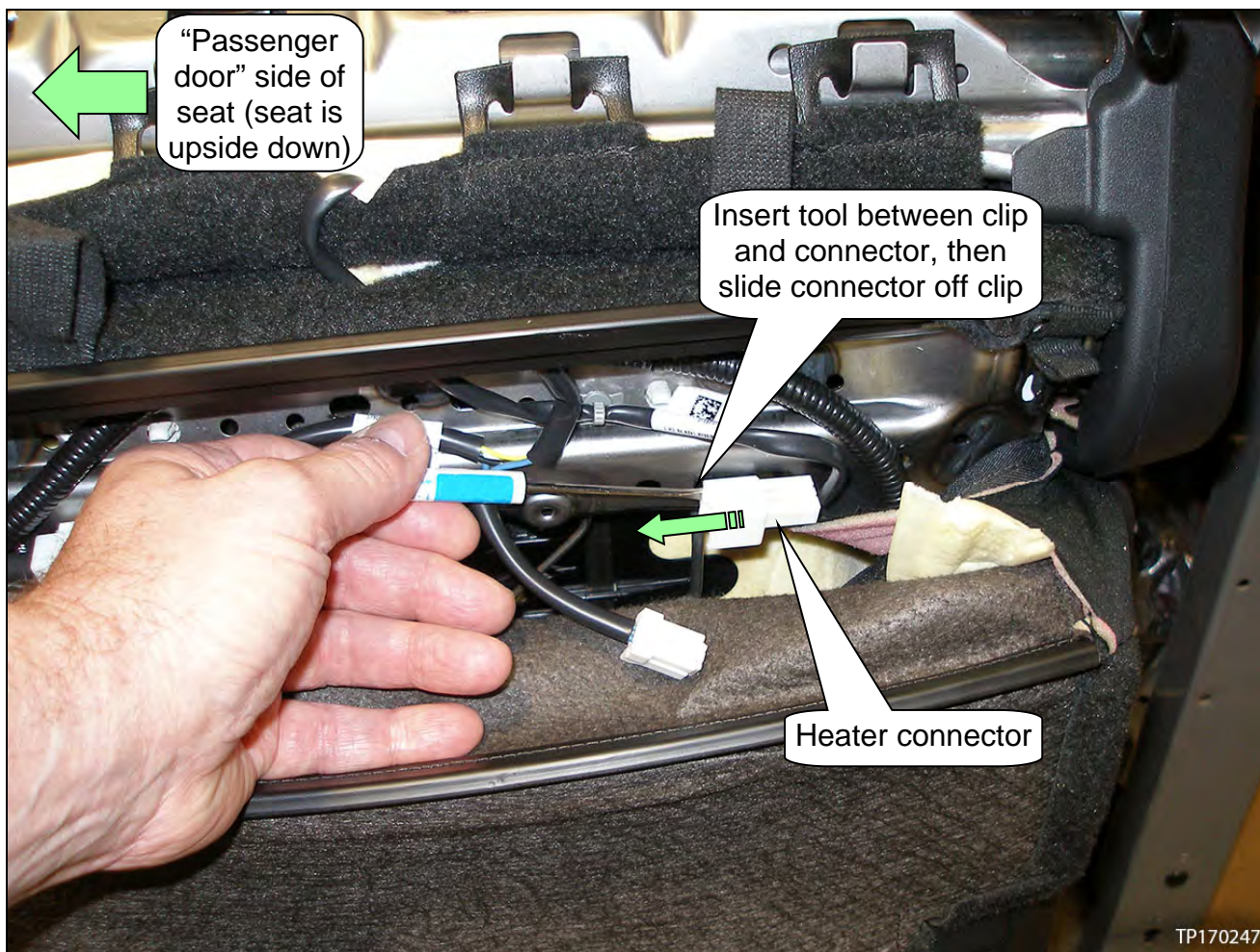

Figure 4

Heated seats only (continued)

Seat Cushion Heater Electrical Harness: Routing

- Route the seat cushion heater's electrical harness as shown in Figure 5 below.

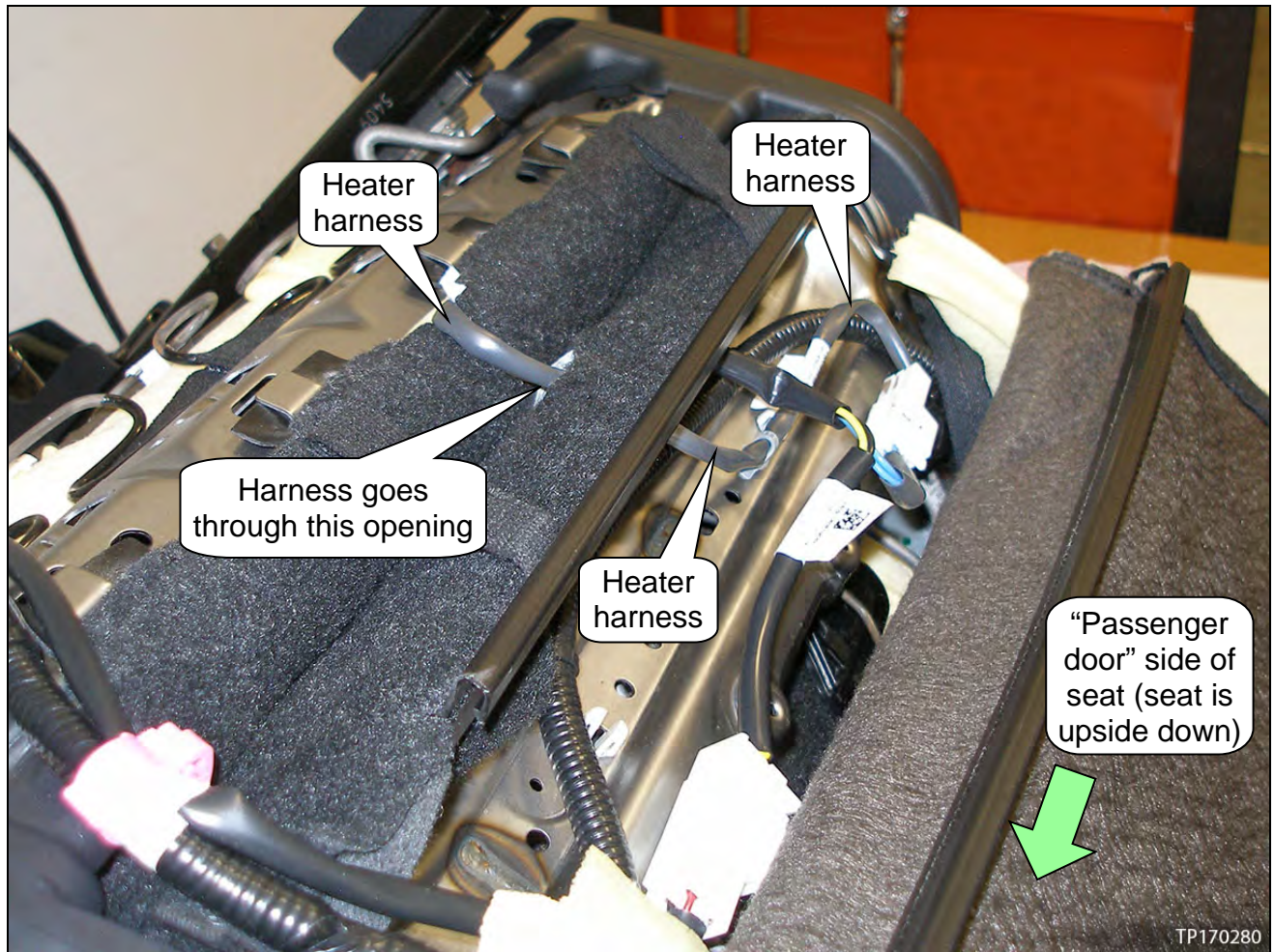

Figure 5

Heated seats only (continued)

Seat Cushion Heater Electrical Connector and Clip: Installation

- Use a new clip for the seat cushion heater's electrical connector on the new seat frame assembly (see Figure 6 below).
 - For the connector clip, refer to **PARTS INFORMATION**.

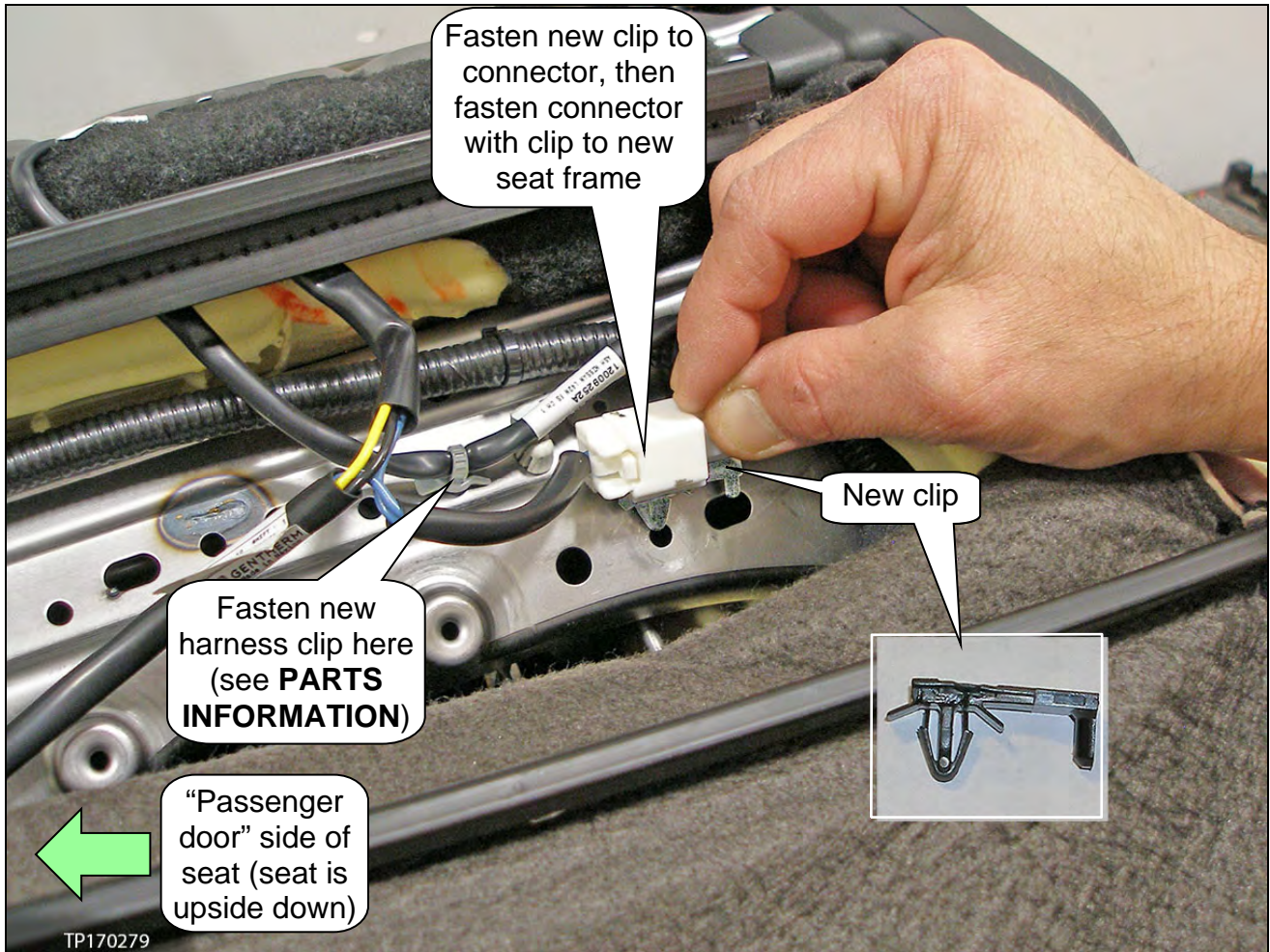

Figure 6

All Seats: Seat Belt Buckle Nut and Seat Mounting Bolts



Figure 7

Zero Point Reset

1. Prepare the vehicle for OCS Zero Point Reset as follows:
 - **Level the vehicle.**
 - **No objects on the passenger seat or in the storage bin.**
 - **No occupants in the vehicle – including the servicing technician.**
 - The CONSULT PC is outside of the vehicle on a suitable support.
 - Do not set the CONSULT PC on the vehicle.
 - Do not touch the vehicle during Zero Point Reset.
 - Minimize vibrations of the vehicle.
2. Connect the plus VI to the vehicle.
3. Open / start CONSULT-III plus (C-III plus).
4. Turn the ignition ON, with engine OFF (engine not running/not in ready mode).
5. Wait for the plus VI to be recognized.
 - The Serial No. will display when the plus VI is recognized.
6. Select **Diagnosis (One System)**.
7. Scroll C-III plus (All systems) and select **OCCUPANT DETECTION**.

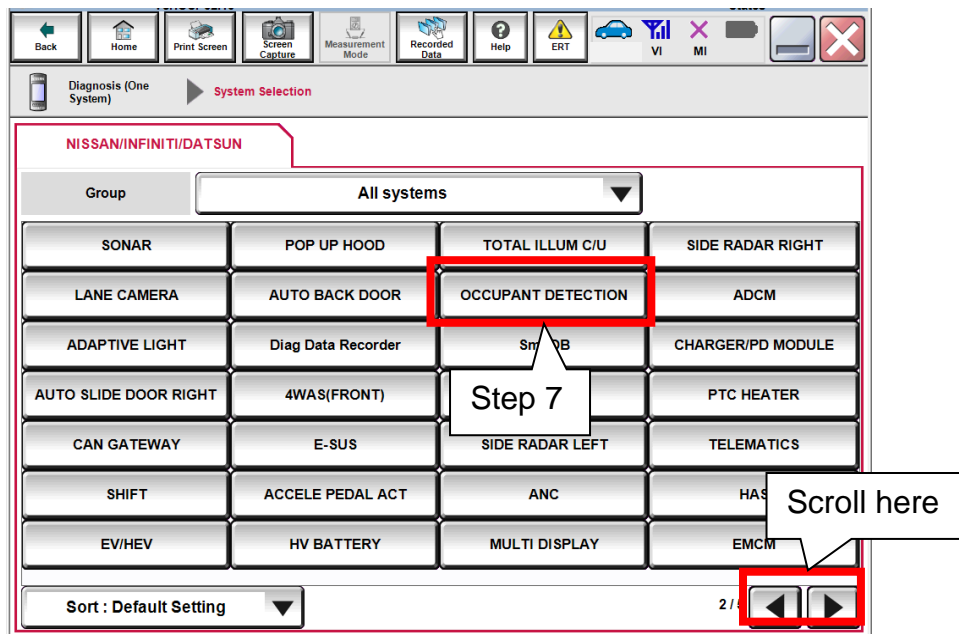

Figure 1A

8. Select **Zero point reset function**.

9. Select **Start**.

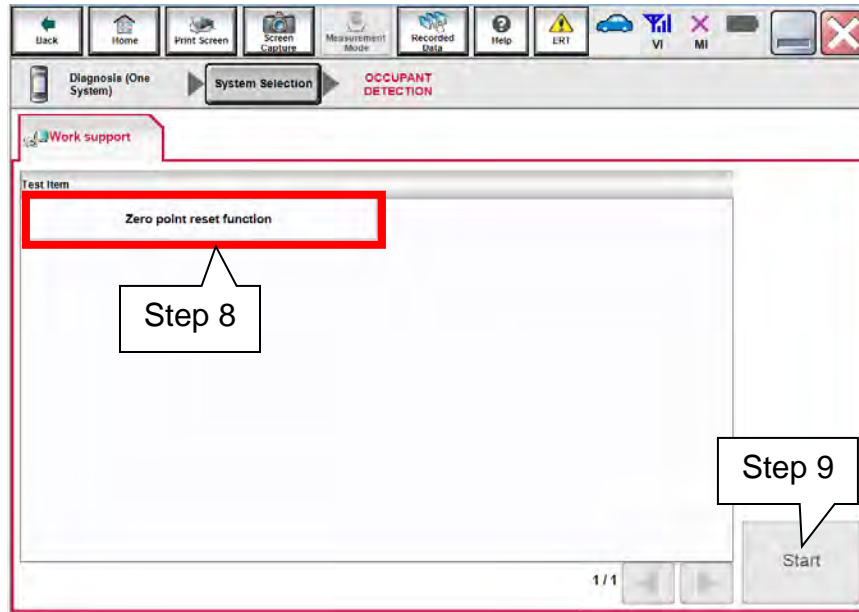

Figure 2A

10. Select **Next**.

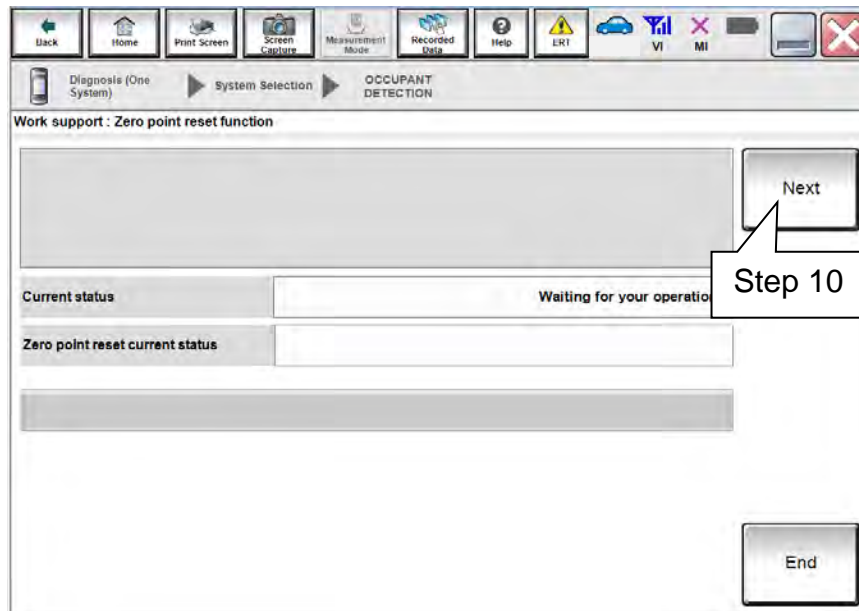

Figure 3A

11. Select **Start**, and then proceed to step 12.

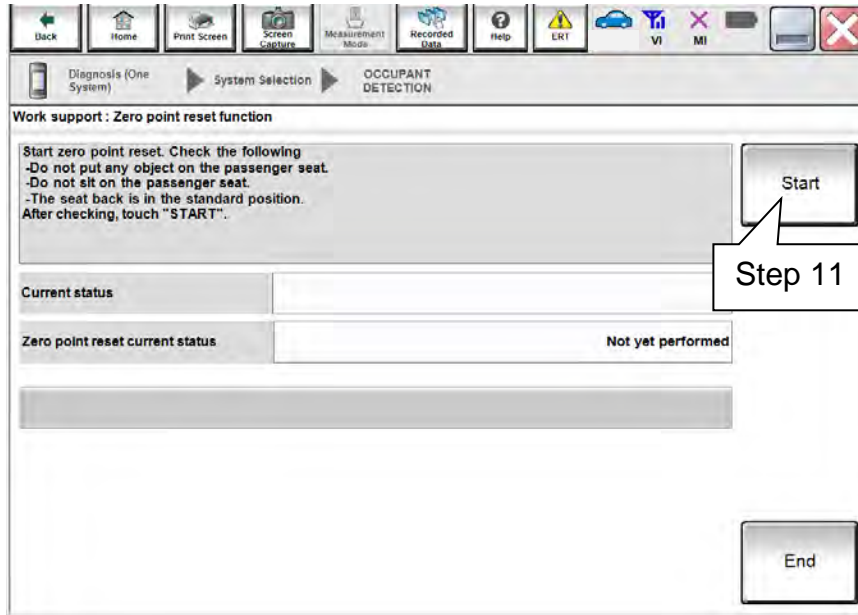

Figure 4A

- After selecting **Start**, if Figure 5A is displayed:
 - a. Check the OCS control unit and confirm its harness connector is completely seated.
 - b. Turn the ignition OFF, and then restart the procedure from step 4 on page 12.

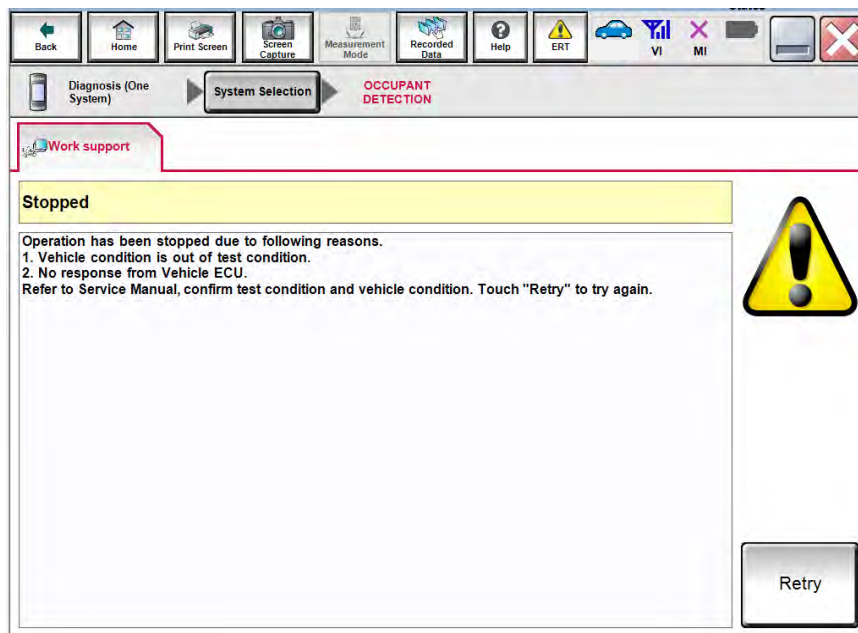

Figure 5A

12. Zero Point Reset **Current status** will display **EXECUTING**.

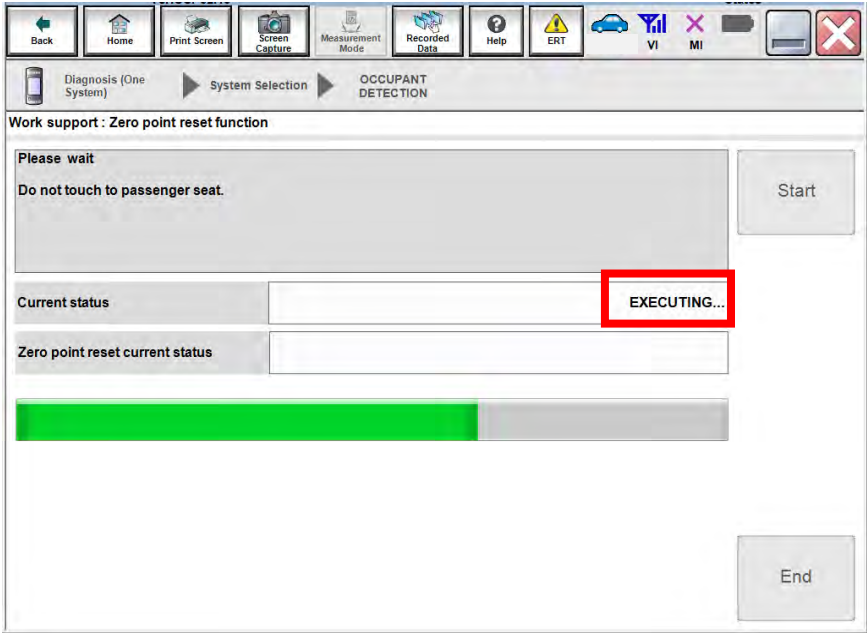

Figure 6A

13. When finished, **Current status** will then display **Completed**.

- Select **End**, and then proceed to step 14.

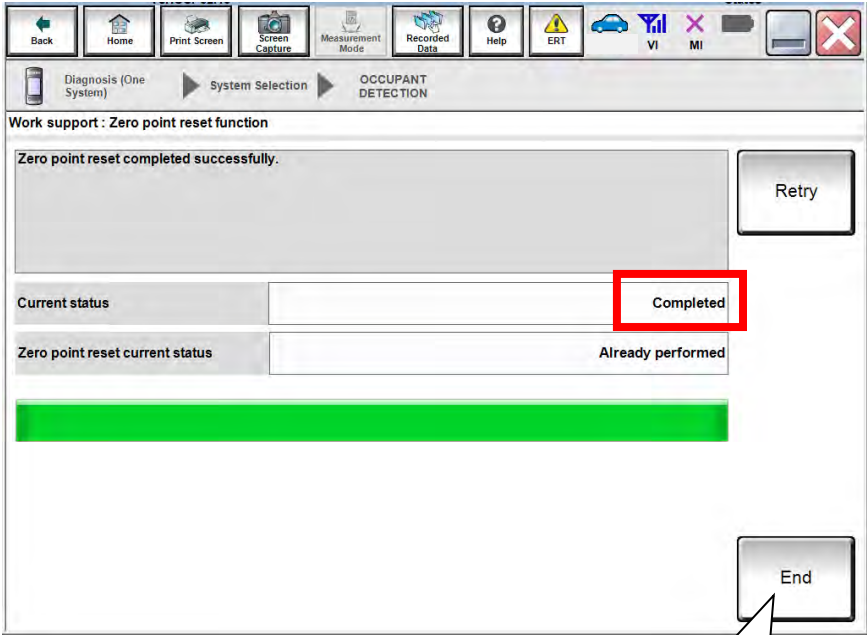



Figure 7A

Step 13

14. Turn the ignition OFF, then ON, and then observe the air bag warning light and front passenger air bag status light:

- The air bag warning light  should illuminate for 7 seconds and then go out.
- The front passenger air bag status light  should illuminate for 7 seconds and then either stay illuminated or go out depending on the occupation of the front passenger seat.

Front Passenger Air bag Status Light Operation

CONDITION	DESCRIPTION	PASSENGER AIR BAG INDICATOR LIGHT	FRONT PASSENGER AIR BAG STATUS
Empty	Empty front passenger seat	ON (illuminated)	INHIBITED
Nobody/Somebody	Bag or Child or Child Restraint or Small Adult in the front passenger seat	ON (illuminated)	INHIBITED
Adult	Adult in front passenger seat	OFF (dark)	ACTIVATED

NOTE: If the air bag warning light or the front passenger air bag status light does not operate as described above there may be an issue not covered by this bulletin. Refer to ASIST and the appropriate Service Manual for additional diagnostic and repair information.

15. Provide the customer with a printed copy of FRONT PASSENGER AIR BAG STATUS LIGHT OPERATION (see last page).

PARTS INFORMATION

DESCRIPTION	PART NUMBER	QUANTITY
BACK & CUSHION & ADJUSTER ASSY (seat frame assembly, black cloth)	87601-4RA3A	1
BACK & CUSHION & ADJUSTER ASSY (seat frame assembly, beige cloth)	87601-4RA3B	
BACK & CUSHION & ADJUSTER ASSY (seat frame assembly, black leather/vinyl)	87601-4RB3A	
BACK & CUSHION & ADJUSTER ASSY (seat frame assembly, beige leather/vinyl)	87601-4RB3B	
BACK & CUSHION & ADJUSTER ASSY (seat frame assembly, alcantara leather/black vinyl)	87601-4RC3A	
BACK & CUSHION & ADJUSTER ASSY (seat frame assembly, alcantara leather/camel vinyl)	87601-4RC3C	
BACK & CUSHION & ADJUSTER ASSY (seat frame assembly, black premium leather/vinyl)	87601-4RD3A	
BACK & CUSHION & ADJUSTER ASSY (seat frame assembly, beige premium leather/vinyl)	87601-4RD3B	
SEAT BELT KIT-FR SEAT BUCKLE, RH (seat belt buckle, black)	86842-4RA9A	
SEAT BELT KIT-FR SEAT BUCKLE, RH (seat belt buckle, beige)	86842-4RA9B	
CLAMP-HOSE (electrical connector clip)	24346-10V03	1 *
CLIP (harness clip)	24225-7991A	1 (for non-heated) 2 (for heated)

* For heated seats only.

CLAIMS INFORMATION

Submit a "CM" line claim using the following claims coding:

CM ID	DESCRIPTION	OP CODE	FRT
P7322	Perform OCS Retrofit	P73222	1.4 hrs



FRONT PASSENGER AIR BAG STATUS LIGHT OPERATION

NOTE: Please print this page and place a copy in the vehicle.

The front passenger seat is equipped with an occupant classification sensor (weight sensor) that turns the front passenger air bag on or off depending on the weight applied to the front passenger seat. The status of the front passenger air bag (ON or OFF) is indicated by the front passenger air bag status light  which is located on the instrument panel. After the ignition switch is placed in the "ON" position, the front passenger air bag status light on the instrument panel illuminates for about 7 seconds and then turns off or remains illuminated depending on the front passenger seat occupied status. The light operates as follows:



CONDITION	DESCRIPTION	PASSENGER AIR BAG INDICATOR LIGHT	FRONT PASSENGER AIR BAG STATUS
Empty	Empty front passenger seat	ON (illuminated)	INHIBITED
Nobody/Somebody	Bag or Child or Child Restraint or Small Adult in the front passenger seat	ON (illuminated)	INHIBITED
Adult	Adult in front passenger seat	OFF (dark)	ACTIVATED