



Technical Service Bulletin

SUBJECT:		No: TSB-17-54-004	
REPLACEMENT PROCEDURE OF ETACS ECU – SERVICE MANUAL REVISION		DATE: August 2017	
		MODEL: See below	
CIRCULATE TO:	<input type="checkbox"/> GENERAL MANAGER	<input checked="" type="checkbox"/> PARTS MANAGER	<input checked="" type="checkbox"/> TECHNICIAN
<input checked="" type="checkbox"/> SERVICE ADVISOR	<input checked="" type="checkbox"/> SERVICE MANAGER	<input type="checkbox"/> WARRANTY PROCESSOR	<input type="checkbox"/> SALES MANAGER

PURPOSE

This TSB updates the Chassis Electrical section of the affected Service Manuals to provide replacement instructions when installing the new ETACS ECU to replace the old ETACS ECU.

AFFECTED VEHICLES

- 2008–10 Lancer, Lancer Ralliart, Lancer Evolution
- 2010 Lancer Sportback
- 2007–10 Outlander

AFFECTED SERVICE MANUALS

- 2008–2010 Lancer Service Manual, Group 54 – Chassis Electrical
- 2008–2010 Lancer Evolution Service Manual, Group 54 – Chassis Electrical
- 2010 Lancer Sportback Service Manual, Group 54 – Chassis Electrical
- 2007–2010 Outlander Service Manual, Group 54 – Chassis Electrical



Please add the information below to the Service Manuals for 2008–2010 Lancer and Lancer Evolution, 2010 Lancer Sportback, and 2007–2010 Outlander; Group 54 – Chassis Electrical –> ETACS–ECU.

ETACS-ECU
HOW TO REPLACE THE OLD WITH THE NEW ETACS-ECU

HOW TO REPLACE THE OLD WITH THE NEW ETACS-ECU

⚠ CAUTION

When the ETACS-ECU is replaced, chassis number writing and coding must be performed.
When diagnosis code No.B1761 "Chassis No. not programmed" or No.B222C "Coding not completed" is set in the ETACS-ECU, diagnose each diagnosis code.

Location of ETACS ECU connectors (comparison between new and old ETACS-ECUs)

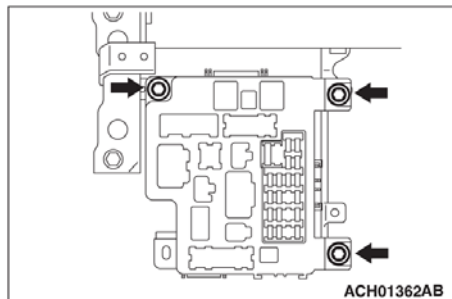
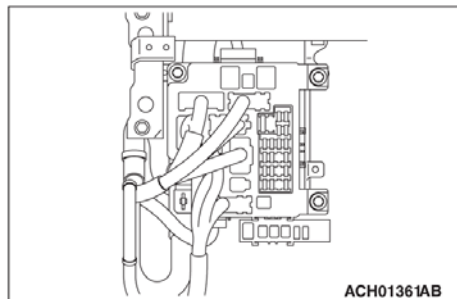
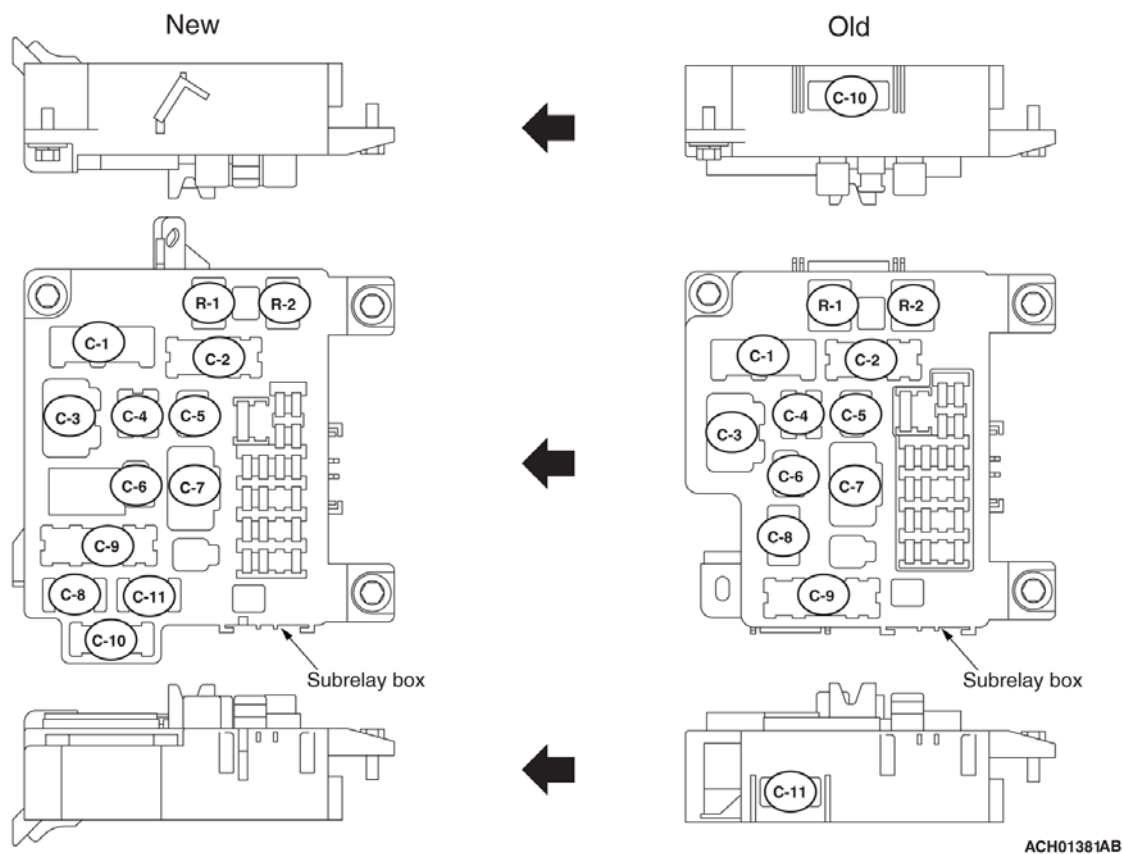

1. Disconnect the wiring harness connectors, the clips and the sub-relay box from the old ETACS-ECU.
2. Remove the bolts as shown to remove the old ETACS-ECU.

ETACS-ECU
HOW TO REPLACE THE OLD WITH THE NEW ETACS-ECU

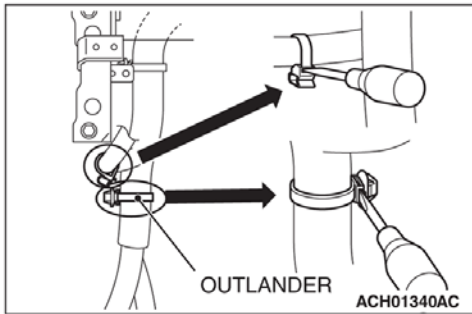

CAUTION

- Do not cut the cable tie-wrap as it may damage the wires.

3. Insert a flat-tipped screwdriver into the tie-wrap lock to release it.

Withdraw the tie-wrap strip from the lock to remove the clip.

NOTE: Dispose of the removed clip.

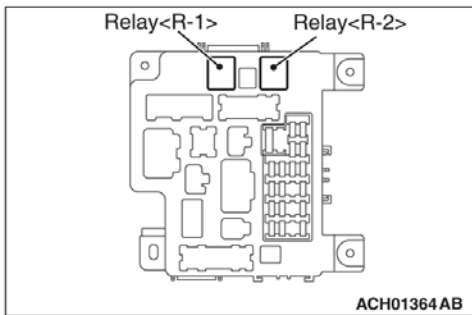

4. Remove the relay from the old ETACS-ECU.

NOTE: Relay <R-1> depends on vehicle equipment.

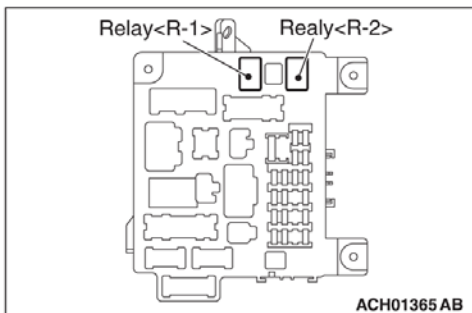

5. Install the relay, which was removed at step 4, to the new ETACS-ECU.

NOTE: Relay <R-1> depends on vehicle equipment.

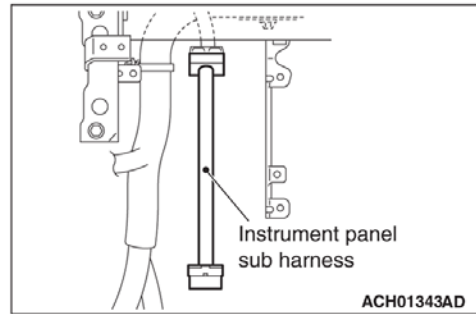

6. Engage the wiring harness connector (female) with the instrument panel sub wiring harness (8522G675) connector (male).

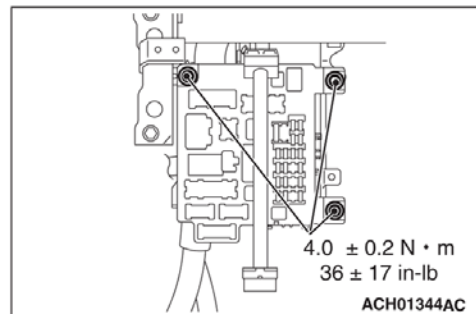

7. Install the new ETACS-ECU.

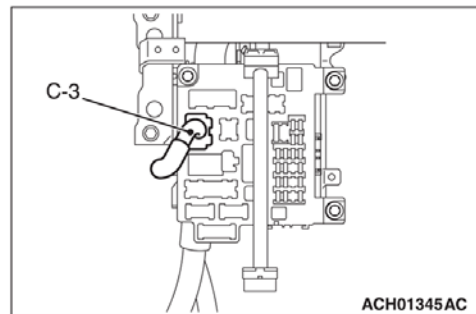

8. Engage the wiring harness connector with C-3 at the ETACS-ECU.

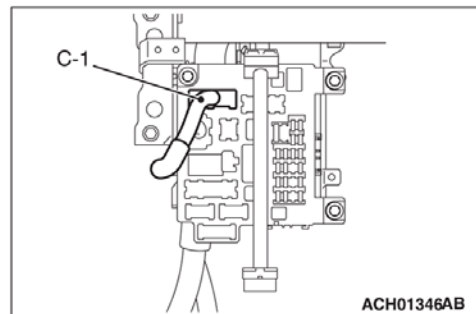

9. Engage the wiring harness connector with C-1 at the ETACS-ECU.

ETACS-ECU HOW TO REPLACE THE OLD WITH THE NEW ETACS-ECU

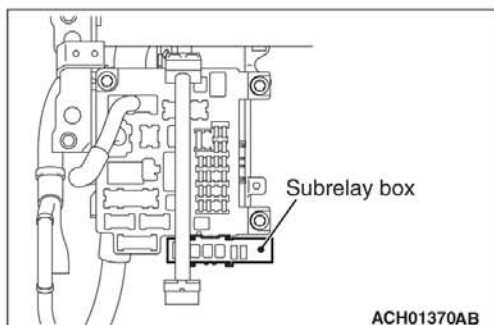

10. Install the sub-relay box.

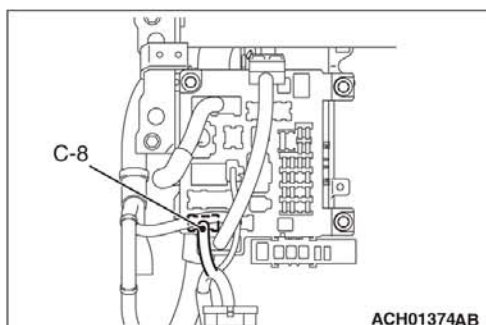

14. Engage the wiring harness connector with C-8 at the ETACS-ECU.

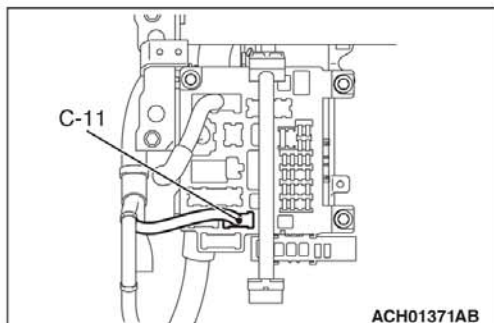

11. Engage the wiring harness connector with C-11 at the ETACS-ECU.

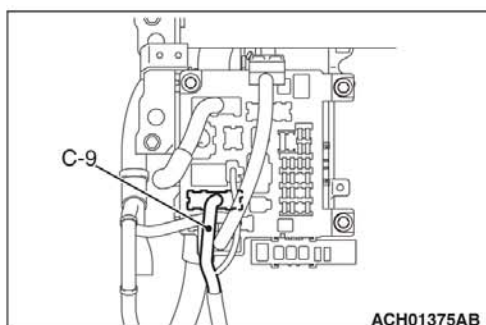

15. Engage the wiring harness connector with C-9 at the ETACS-ECU.

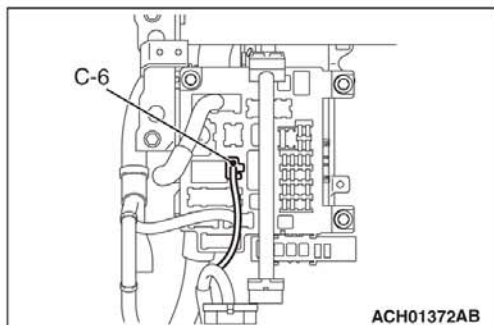

12. Engage the wiring harness connector with C-6 at the ETACS-ECU.

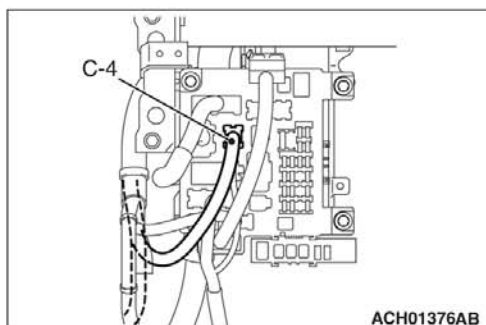

16. Engage the wiring harness connector with C-4 at the ETACS-ECU.

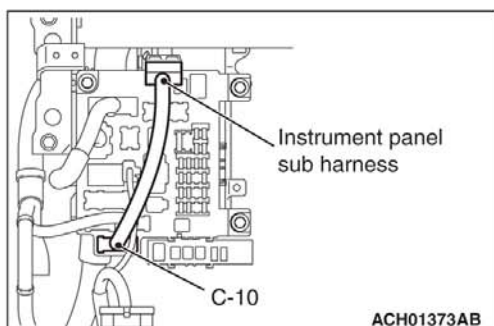

13. Engage the instrument panel sub wiring harness connector (female) with C-10 at the ETACS-ECU.

ETACS-ECU HOW TO REPLACE THE OLD WITH THE NEW ETACS-ECU

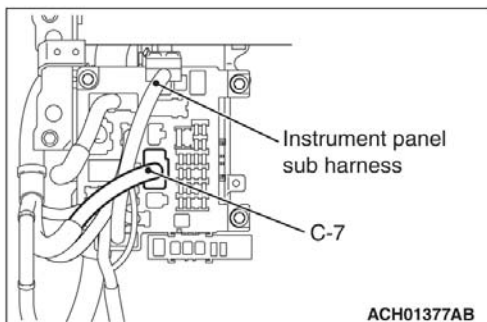

CAUTION

The wiring harness connector, which is connected to C-7 at the ETACS-ECU, should be routed behind the instrument panel sub wiring harness.

17. Engage the wiring harness connector with C-7.

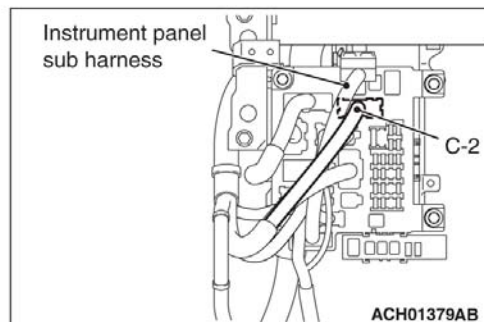

CAUTION

The wiring harness connector, which is connected to C-2 at the ETACS-ECU, should be routed behind the instrument panel sub wiring harness.

19. Engage the wiring harness connector with C-2 at the ETACS-ECU.

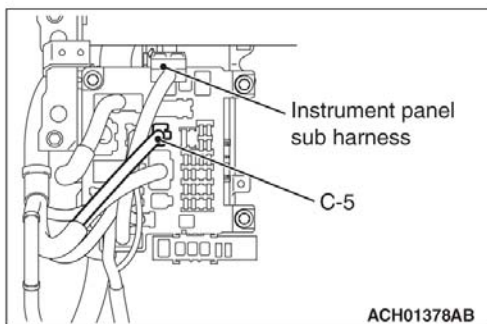

CAUTION

The wiring harness connector, which is connected to C-5 at the ETACS-ECU, should be routed behind the instrument panel sub wiring harness.

18. Engage the wiring harness connector with C-5 at the ETACS-ECU.

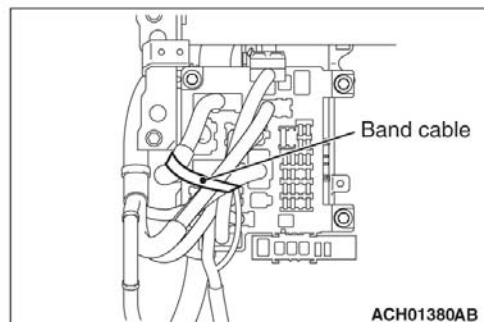

20. Locate the wiring harness and the pair of the instrument panel sub wiring harness so that they do not interfere with the edge of the bracket. Then secure them with the cable tie-wrap (MB249340).