

PREVOST

Instruction Sheet

IS-15003C

BOSCH HD10 24V-150A ALTERNATOR CONVERSION KIT – TWIN BOSCH MOUNTED ON VOLVO D13 ENGINE

REVISION :C	THIS INSTRUCTION SHEET SUPERSEDES PREVIOUS VERSION.
Part #564590 ADAPTER changed for #060297	

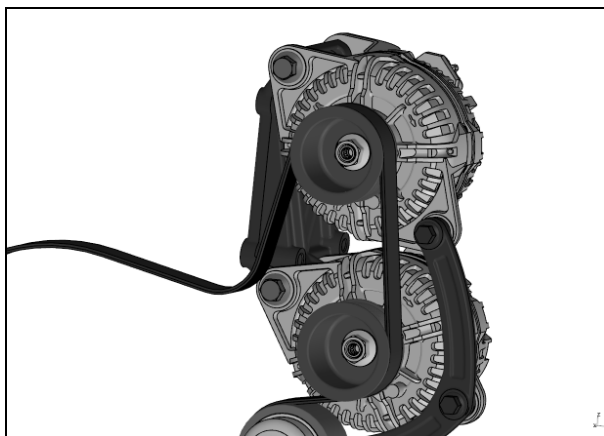

IMPORTANT NOTE: It is mandatory to install two alternators of same rated amperage on the vehicle. The twin Bosch installation cannot combine one 120A and one 150A simultaneously.

The conversion to twin 150A Bosch alternator requires a 3/0 gauge power cable (circuit 102/102A), included in this kit.

APPLICATION

H3 Series equipped with Volvo D13 engine
X3 Series starting from US10 compliant Volvo D13 engine

MATERIAL

H3 SERIES VEHICLES. Kit #069425 includes the following parts:

Part No.	Description	Qty
069184	CABLE, POWER 3/0 GAUGE 2600mm lg (CIRCUIT 102A)	1
502573	WASHER, FLAT 6.4 x 12.5 x 1.6 STAINLESS STEEL	2
500169	SCREW, CAP ¼-20 x 1 ½ GR5	3
502716	NUT, NYRT ¼-20	3
509490	DOUBLE-TIE MOUNT, HELLERMANN TYTON, GREY	3
060297	ADAPTER	1
564593	ALTERNATOR, BOSCH HD10PLBH 24V-150A	2
504637	CABLE TIE	20
504751	ANCHOR, DOUBLE SWIVEL	1
507664	CABLE TIE, DOUBLE LOOP	10
509491	CABLE TIE, WIDE	10
5001182	NUT, M6 STAINLESS STEEL	2
5001341	WASHER, FLAT 8.4 x 17 x 1.6 STAINLESS STEEL	3
5001787	NUT, M8 STAINLESS STEEL	2
IS-15003	Instruction Sheet	1
FI-15003	Feuille d'instructions	1

X3 SERIES VEHICLES. Kit #069426 includes the following parts:

Part No.	Description	Qty
069222	CABLE, POWER 3/0 GAUGE 2000mm lg (CIRCUIT 102A)	1
502573	WASHER, FLAT 6.4 x 12.5 x 1.6 STAINLESS STEEL	2
500169	SCREW, CAP ¼-20 x 1 ½ GR5	3
502716	NUT, NYRT ¼-20	3
509490	DOUBLE-TIE MOUNT, HELLERMANN TYTON, GREY	3
060297	ADAPTER	1
564593	ALTERNATOR, BOSCH HD10PLBH 24V-150A	2
504637	CABLE TIE	20
504751	ANCHOR, DOUBLE SWIVEL	1
507664	CABLE TIE, DOUBLE LOOP	10
509491	CABLE TIE, WIDE	10
5001182	NUT, M6 STAINLESS STEEL	2
5001341	WASHER, FLAT 8.4 x 17 x 1.6 STAINLESS STEEL	3
5001787	NUT, M8 STAINLESS STEEL	2
IS-15003	Instruction Sheet	1
FI-15003	Feuille d'instructions	1

Other parts that may be required:

Part No.	Description	
684013	COLOR GUARD RUBBER COATING, 14.5 OZ CAN	
5001853	SCREW, CAP ALTERNATOR MOUNTING M12-1.75 x 130 G10.9	QTY: 2
5001761	NUT, HEX ALTERNATOR MOUNTING M12-1.75	QTY: 2
5001801	SCREW, CAP ALTERNATOR MOUNTING M10-1.5x55 G10.9	QTY: 2
5001930	NUT, HEX ALTERNATOR MOUNTING M10-1.5 G10.9	QTY: 2
680038	LOCTITE 243, BLUE	
680335	ANTI-SEIZE COMPOUND	

NOTE

Material can be obtained through regular channels.

REQUIRED TOOLS

<p>RATCHET AND SOCKET SET - METRIC</p> 	<p>TORQUE WRENCH</p> 	<p>BRASS WIRE CUP BRUSH</p> 
--	--	---

SPECIAL TOOLS THAT CAN BE USEFUL TO TIGHTEN THE ALTERNATOR PULLEY MOUNTING NUT



METRIC 10mm 12-POINTS SPLINE DRIVE LONG (CARLYLE SLTS3810M AVAILABLE FROM NAPA)



OFFSET 7/8 WRENCH (CYLINDER HEAD WRENCH), SNAP-ON PART NUMBER M4201



7/8 SOCKET (PART NUMBER WA28-28A)

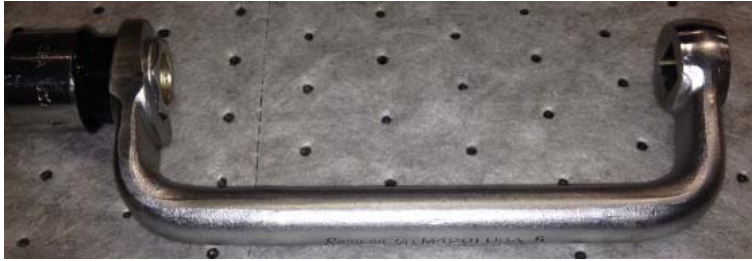

OFFSET 7/8 WRENCH FITTED WITH 7/8 SOCKET AND 10mm 12-POINTS SPLINE DRIVE



USING THE CYLINDER HEAD WRENCH WITH A RATCHET AND A FLEX SOCKET WRENCH



PROCEDURE



DANGER

Park vehicle safely, apply parking brake, stop engine and set battery master switch(es) to the OFF position prior to working on the vehicle.

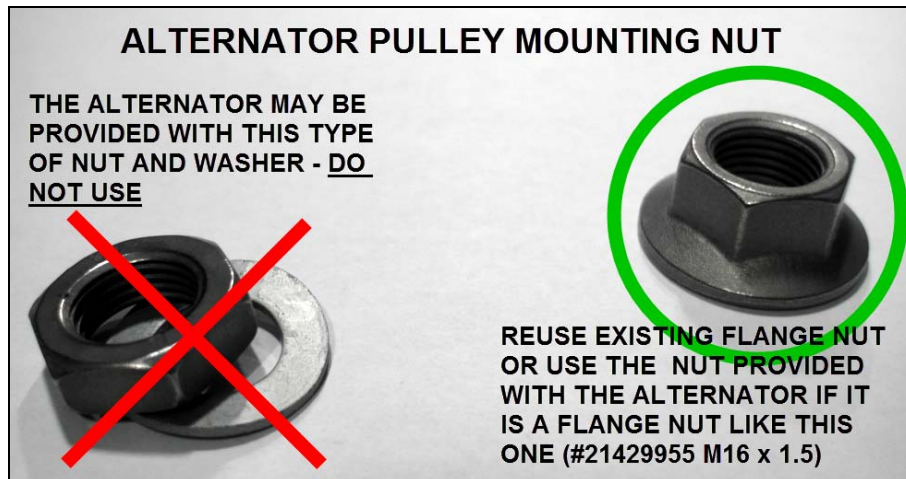

FIGURE 1: PULLEY MOUNTING NUT – DO NOT USE THE STANDARD NUT AND SPRING WASHER THAT MAY BE PROVIDED WITH THE ALTERNATOR. A FLANGE NUT MUST BE USED



FIGURE 2: POWER CABLE 3/0 #069184 OR # 069222

1. Remove the A/C compressor belts and then remove A/C compressor idler pulley bracket assembly (3 bolts to be removed, FIGURE 3).

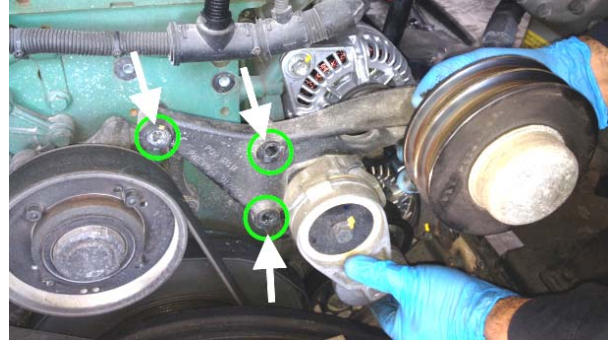

FIGURE 3

2. Remove the alternator belt (FIGURE 4).
3. Unscrew the alternator pulley mounting nut (FIGURE 4). **Keep nut for reuse** if nut provided with the alternator is not a flange nut.
4. Remove the alternator pulley (2 pulleys) (FIGURE 4).

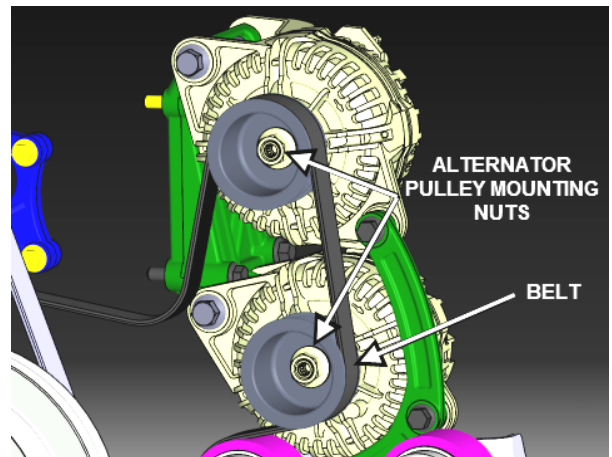

FIGURE 4

5. **Disconnect power cable (circuit 102/102A) from the 24VI junction block or relay R1 as applicable in the rear junction box/main power compartment (FIGURE 8 & FIGURE 10).**
6. Identify and disconnect alternator cables. Properly clean cable ring terminals as applicable using a brass wire cup brush, a Scotch-Brite pad or an emery cloth.

Take note that the existing 2/0 gauge power cable (identified 102 or 102A depending on the type of vehicle) connected to the upper alternator and routed up to the main power compartment will not be reused.



BRASS WIRE CUP BRUSH

7. Remove the existing alternators. To do so, unscrew identified mounting bolts on FIGURE 5 and keep for reuse.

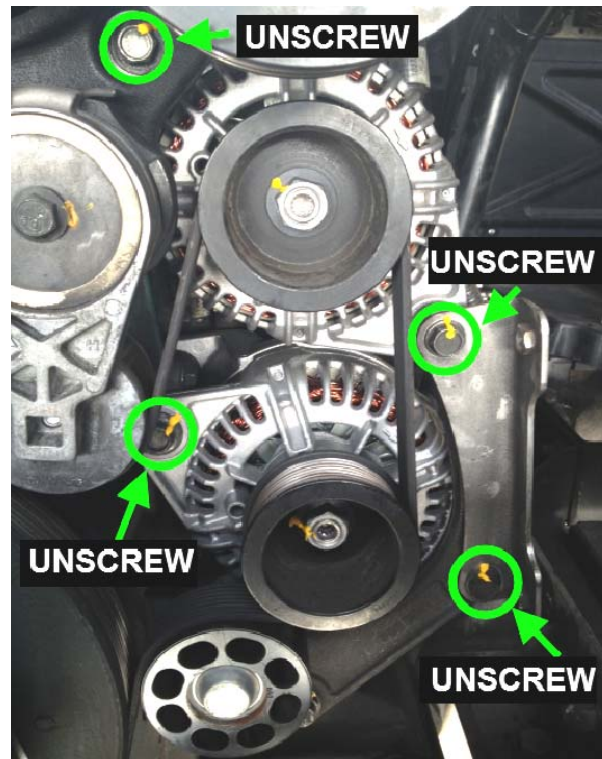

FIGURE 5

8. Install new alternators. Fix lower and upper alternators loosely to alternator supports using bolts **C**. **Apply anti-seize compound inside the alternator mounting ears and inside the sleeves found on the support attached to the engine** (see location C on FIGURE 6). Also, mount arched support loosely onto alternators using bolts **B** (FIGURE 6).

For reference:

C= bolt M12 #5001853

C= nut M12 #5001761

B= bolt M10 #5001801

B= nut M10 #5001930

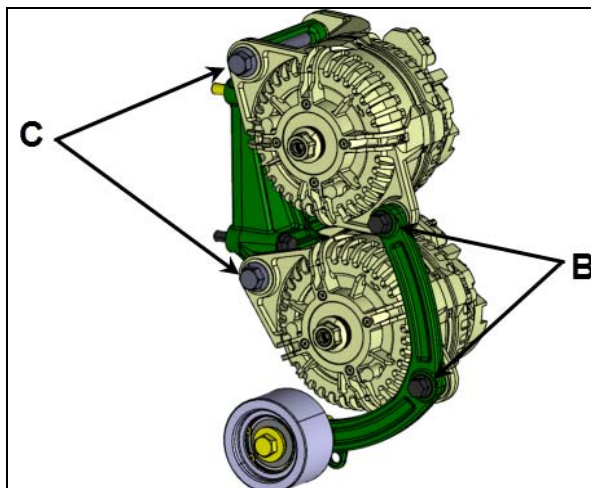

FIGURE 6

9. Replace the existing 2/0 gauge power cable (circuit 102 or 102A) (FIGURE 7) with new 3/0 power cable (FIGURE 2). This cable is routed from the upper alternator B1+ stud terminal up to the 24VI junction block in the rear junction box/main power compartment (FIGURE 8, FIGURE 9, FIGURE 10 & FIGURE 11).

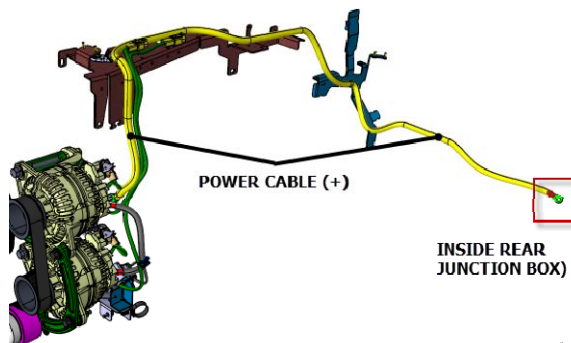

FIGURE 7

- a) While removing power cable 102/102A, separate the Automatic Fire Suppression System (AFSS) LTD wire attached to the power cable if applicable depending on your vehicle option and actual LTD installation. The LTD will be reinstalled on new power cable 102/102A similarly using appropriate nylon ties later on.

- b) It is recommended to install the new power cable simultaneously with the removal of former power cable already there in order to use up to a certain point, the same attachment points and to place appropriate nylon ties at the same locations. Start in the rear junction box/main power compartment.

Installation of power cable 3/0 will require the use of 3 HellermannTyton double-tie mounts #509490 and corresponding hardware:

3x cap screw #500169,

3x nylon insert nut #502716,

3x wide nylon tie #509491,

3x nylon tie #504637.

Use FIGURE 12, FIGURE 13, FIGURE 14, FIGURE 15 & FIGURE 16 as reference to complete the installation.

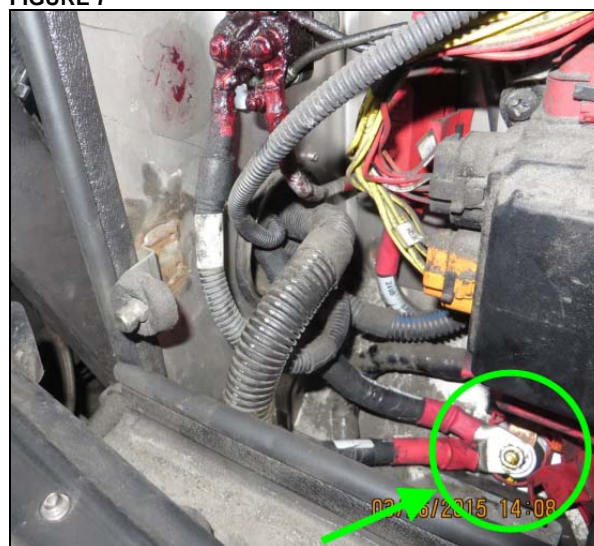

FIGURE 8: X3 SERIES - POWER CABLE 102A CONNECTED TO BUSMAN JUNCTION BLOCK - **TORQUE 10 lbf-ft**. APPLY COLOR GUARD RUBBER COATING

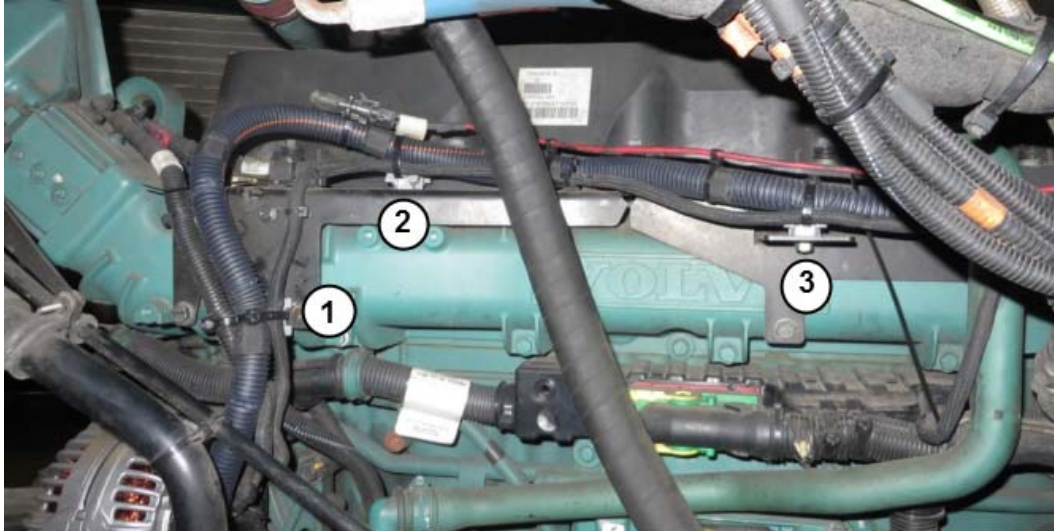

FIGURE 12: POWER CABLE ATTACHED TO #1, #2, #3 DOUBLE-TIE MOUNT AND PROPER NYLON TIES INSTALLATION

HellermannTyton double-tie mounts mounting screw torque: **8 lbf-ft.**

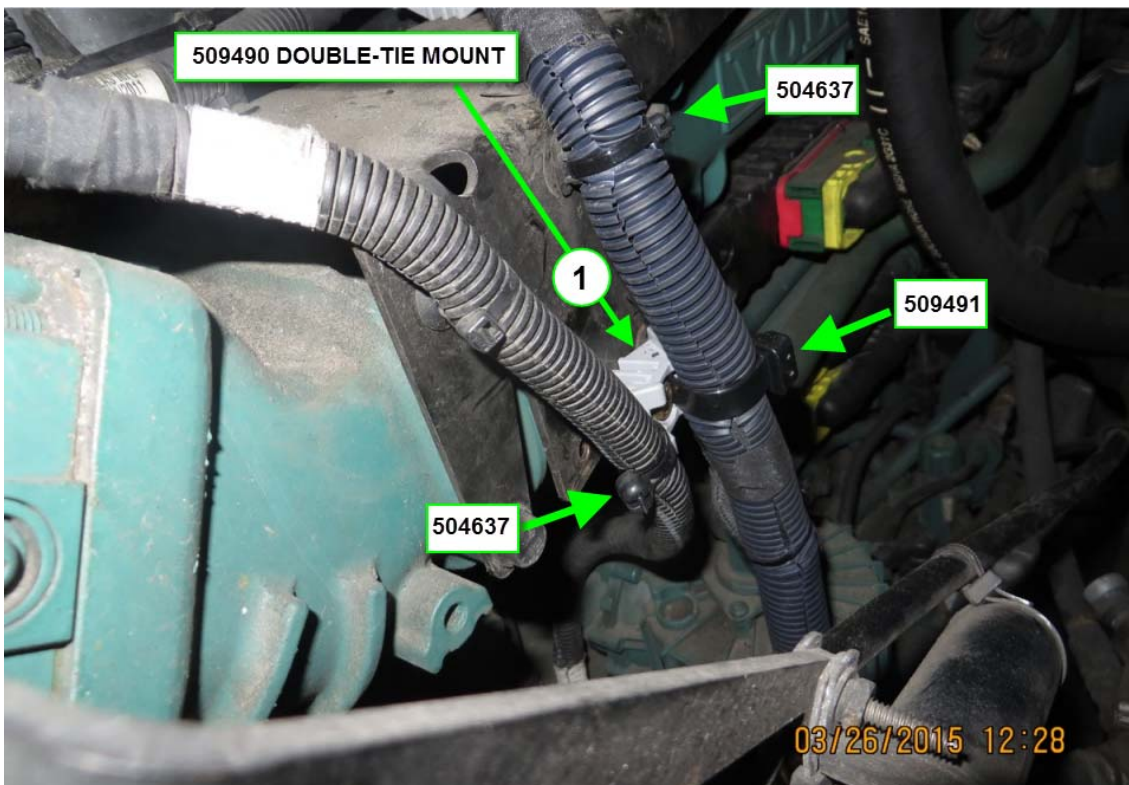

FIGURE 13: POWER CABLE ATTACHED TO #1 DOUBLE-TIE MOUNT AND PROPER NYLON TIES INSTALLATION

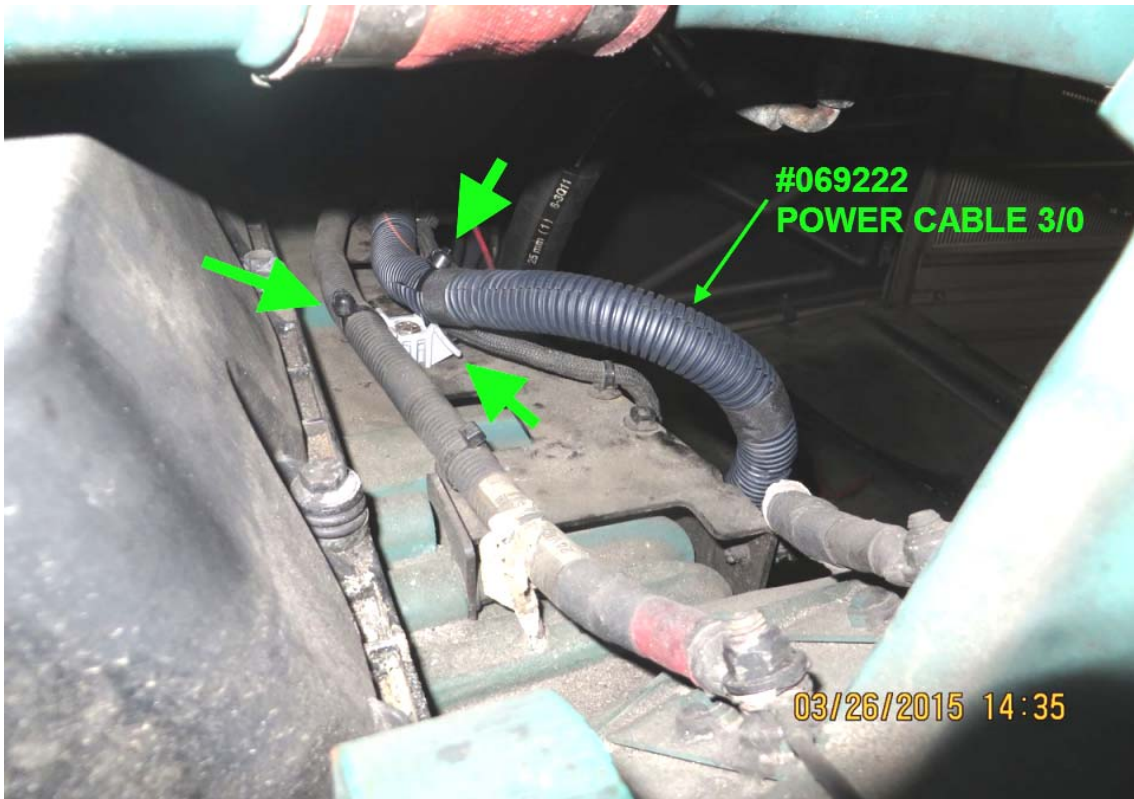

FIGURE 14: POWER CABLE ATTACHED TO #2 DOUBLE-TIE MOUNT AND PROPER NYLON TIES INSTALLATION



FIGURE 15: POWER CABLE ATTACHED TO #2 DOUBLE-TIE MOUNT AND PROPER NYLON TIES INSTALLATION



FIGURE 16: POWER CABLE ATTACHED TO #2, #3 DOUBLE-TIE MOUNT AND PROPER NYLON TIES INSTALLATION

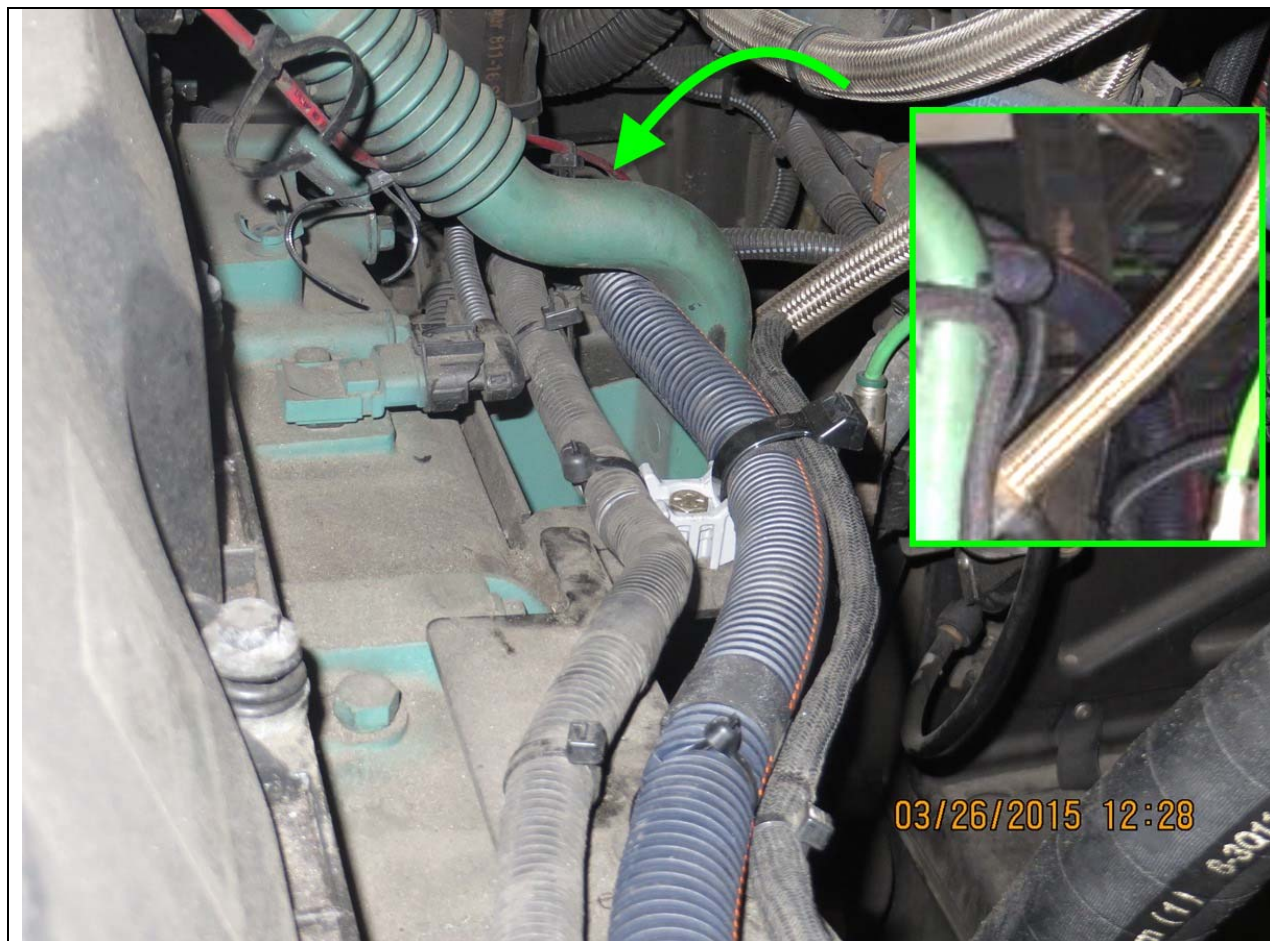
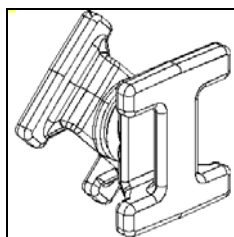

FIGURE 17: X3 SERIES - USING DOUBLE SWIVEL ANCHOR AND 2 WIDE NYLON TIES, SECURE THE POWER CABLE TO THE AIR COMPRESSOR INLET HOSE

ON H3 SERIES, USE THIS DEVICE TO SECURE THE POWER CABLE TO NEARBY COMPONENTS AS REQUIRED.



DOUBLE SWIVEL ANCHOR

10. If applicable, reinstall the LTD along the power cable using double-loop nylon ties #507664 as previously installed. For proper installation and location, refer to FIGURE 18 to FIGURE 22 and read LTD INSTALLATION GUIDELINES in this document.

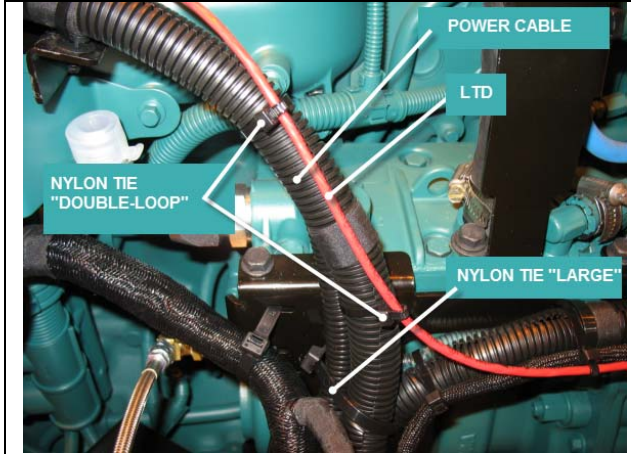

FIGURE 18



FIGURE 19

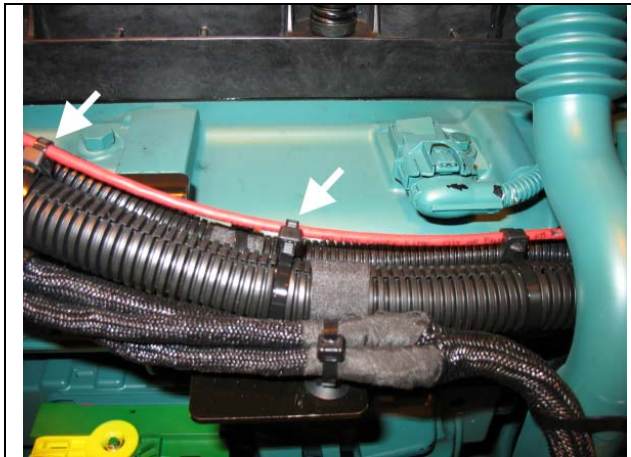

FIGURE 20

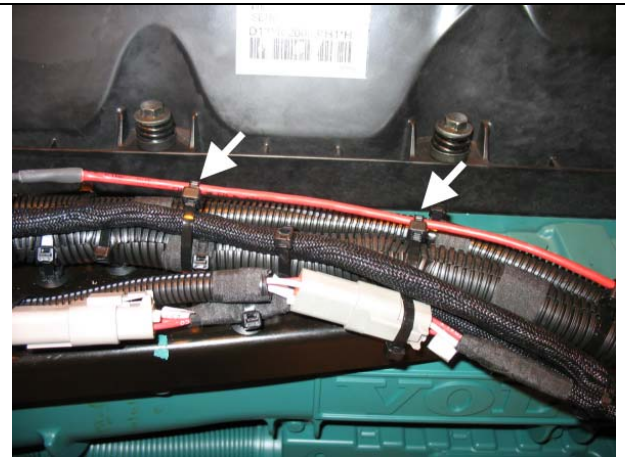

FIGURE 21



FIGURE 22

LTD INSTALLATION GUIDELINES

IMPORTANT: WHEN INSTALLING THE "LTD", THE FOLLOWING GUIDELINES MUST BE FOLLOWED.

NOTE
Always use double loop cable ties to secure LTD. LTD must be tied alone, with no other cables in the loop.

NOT ALLOWED

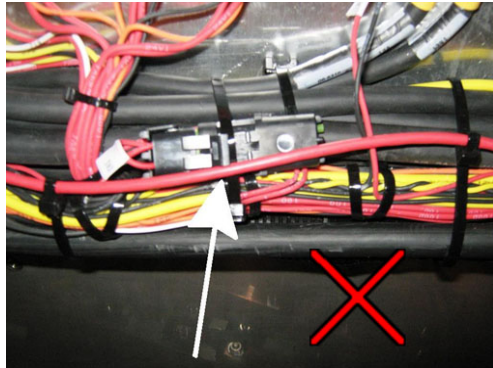

Possible contact or rubbing against screws, edges, etc.

CORRECT

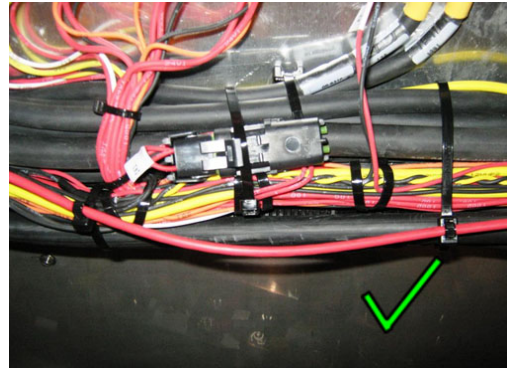

LTD must be routed clear of screws, sharp edges, etc.

NOT ALLOWED

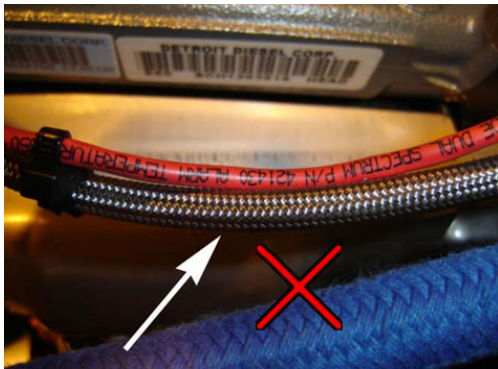

Rubbing or possible rubbing against abrasive surfaces

CORRECT

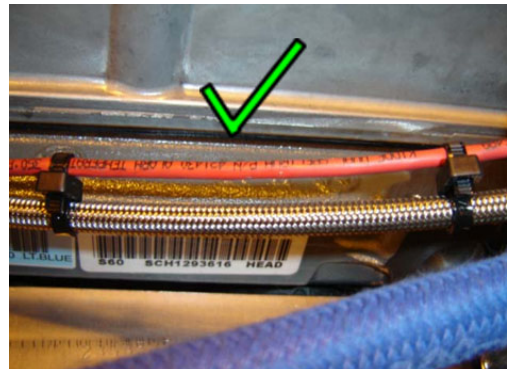

LTD must be secured with double loop cable ties. Distance between cable ties must not exceed 4 inches (100mm) max

NOT ALLOWED

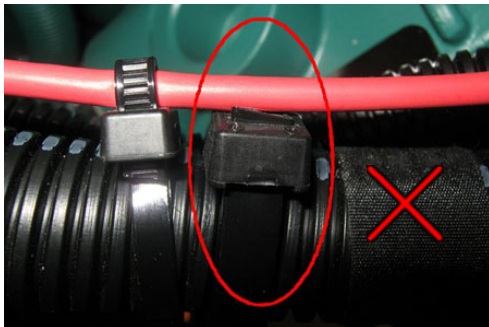

LTD touching cut cable tie

NOT ALLOWED

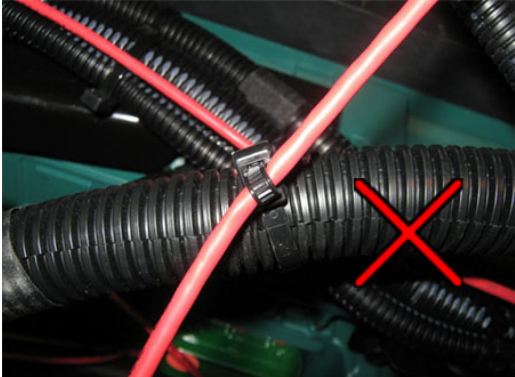

LTD extending slantingly from the cable tie

CORRECT



LTD is not a flexible harness. Avoid tight bends and kinks which could short circuit the LTD. Loops must have a minimum radii of 4 inches (100 mm)

NOT ALLOWED

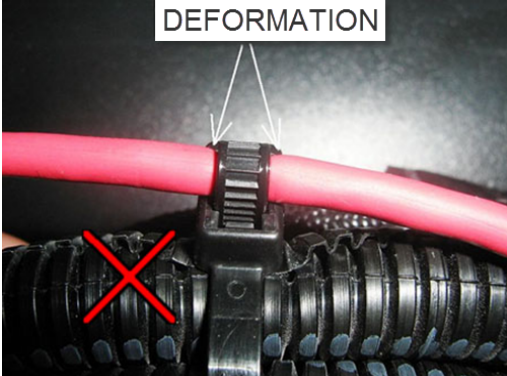

Cable tie tighten in excess on the LTD. Tighten cable tie on LTD by hand only. Tighten just enough to prevent LTD from slipping from once side to the other inside the cable tie loop

CORRECT

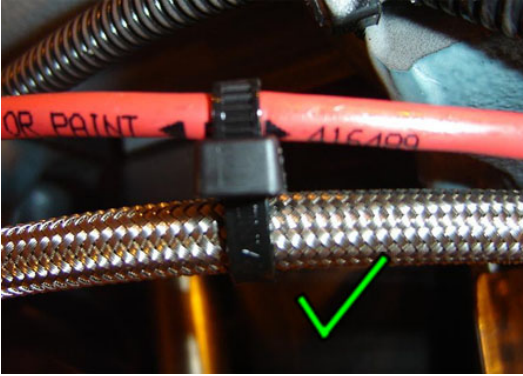

Proper tightening of the cable tie on the LTD

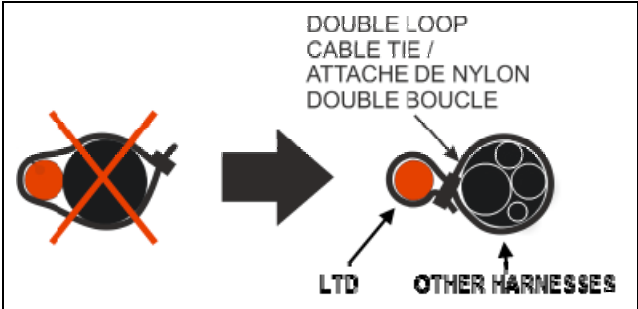

11. In order to assure proper installation, it is important to tighten the alternator mounting bolts in the following proper sequence. Use Loctite 243 blue on threads (FIGURE 23).

1st Bolt/Nut B, 43 lbf-ft (2x).

2nd Bolt/Nut C, 74 lbf-ft (2x).

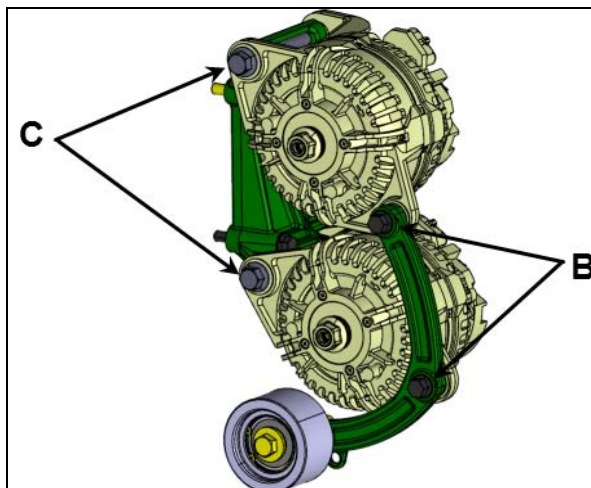

FIGURE 23

12. Mount pulley onto alternators (FIGURE 24). Use Loctite 243 blue on threads. Tighten pulley mounting nut to **75 lbf-ft**.

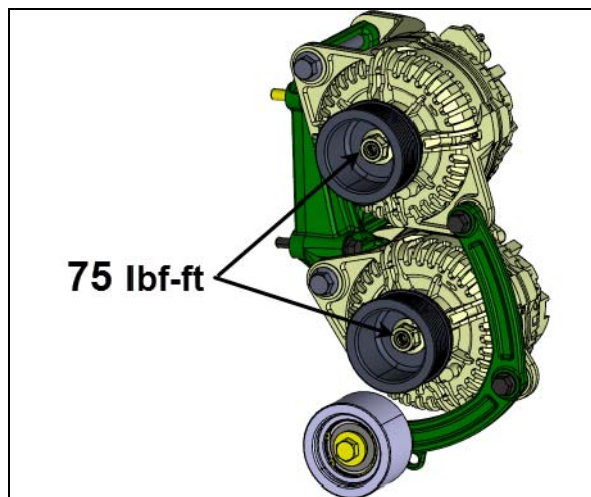

FIGURE 24

13. Install the alternator belt (FIGURE 25)

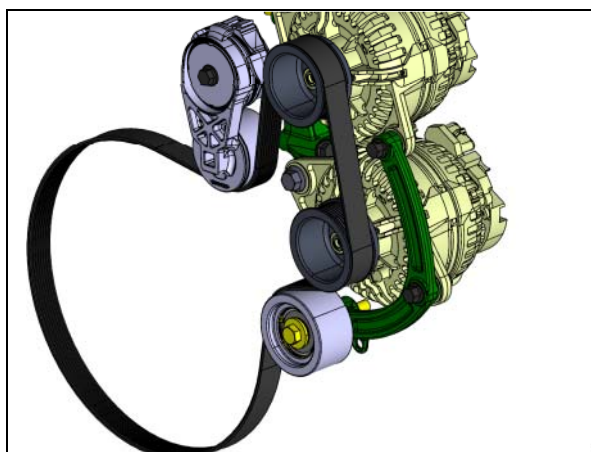

FIGURE 25

14. Cable connection overview. Upper and lower alternator (FIGURE 26).

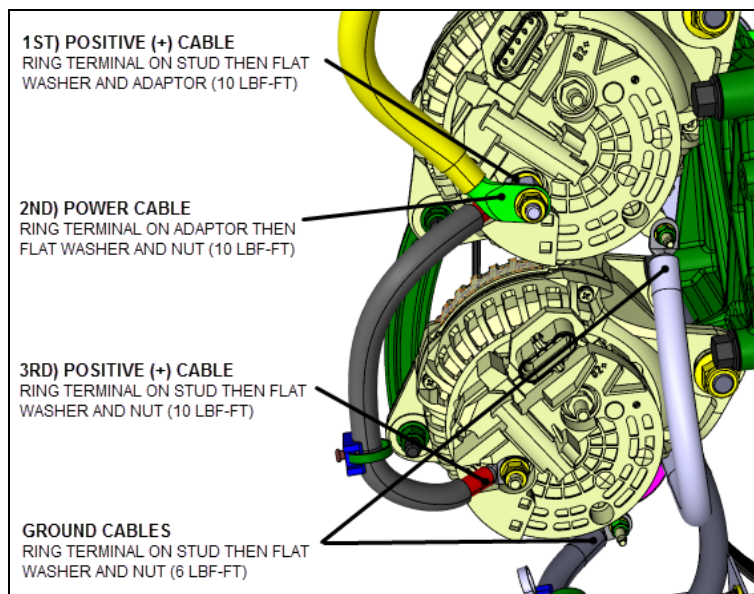

FIGURE 26

UPPER ALTERNATOR - (use new hardware for cable connection)

15. Power cable and jumper (positive) cable.

- a) Install jumper cable (a.k.a. positive cable) onto **B1+** stud terminal on upper alternator (FIGURE 27).
- b) Place one new flat washer #5001341 against the cable ring terminal (FIGURE 27).
- c) Screw and tighten the adaptor stud #060297 (torque: 10 lbf-ft) (FIGURE 27) prior installing power cable.
- d) Fit the power cable terminal onto adaptor stud, place one new flat washer #5001341 against the power cable terminal and screw a new nut #5001787 (nut torque: 10 lbf-ft) (FIGURE 27).

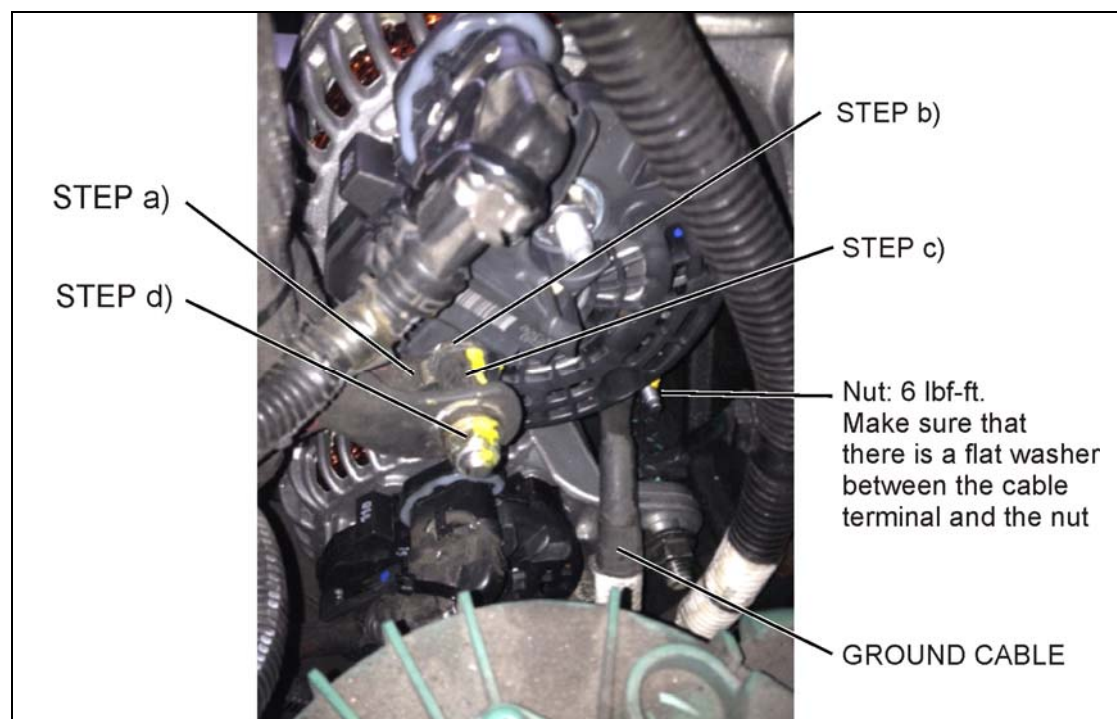

FIGURE 27

15. Fit the ground cable onto the alternator ground stud, place one new flat washer #502573 against the ground cable terminal and screw a new nut #5001182 (nut torque: 6 lbf-ft) (FIGURE 27).
16. Plug alternator harness onto alternator connector and secure using nylon cable ties (FIGURE 28).

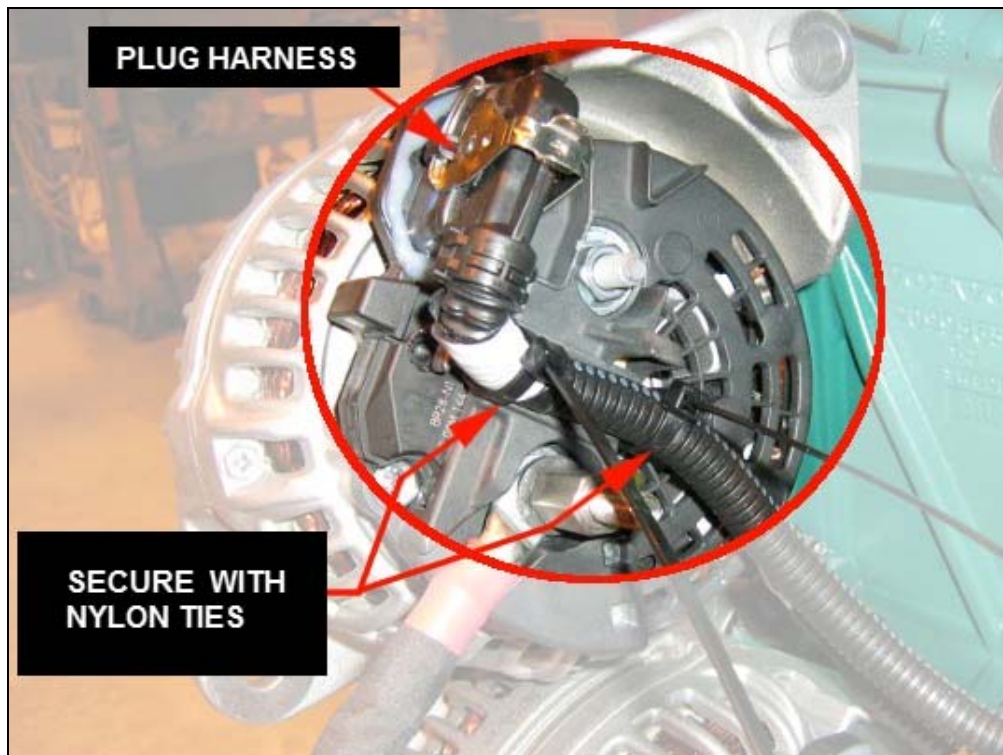

FIGURE 28

LOWER ALTERNATOR - (use new hardware for cable connection)

17. Jumper (positive) cable.
 - a) Fit jumper cable (positive cable) onto **B1+** stud terminal on lower alternator (FIGURE 29).
 - b) Place one new flat washer #5001341 against the cable ring terminal and screw new nut #5001787 (nut torque: 10 lbf-ft) (FIGURE 29).
 - c) Fit the ground cable onto the alternator ground stud, place one new flat washer #502573 against the ground cable ring terminal and screw a new nut #5001182 (nut torque: 6 lbf-ft) (FIGURE 29).

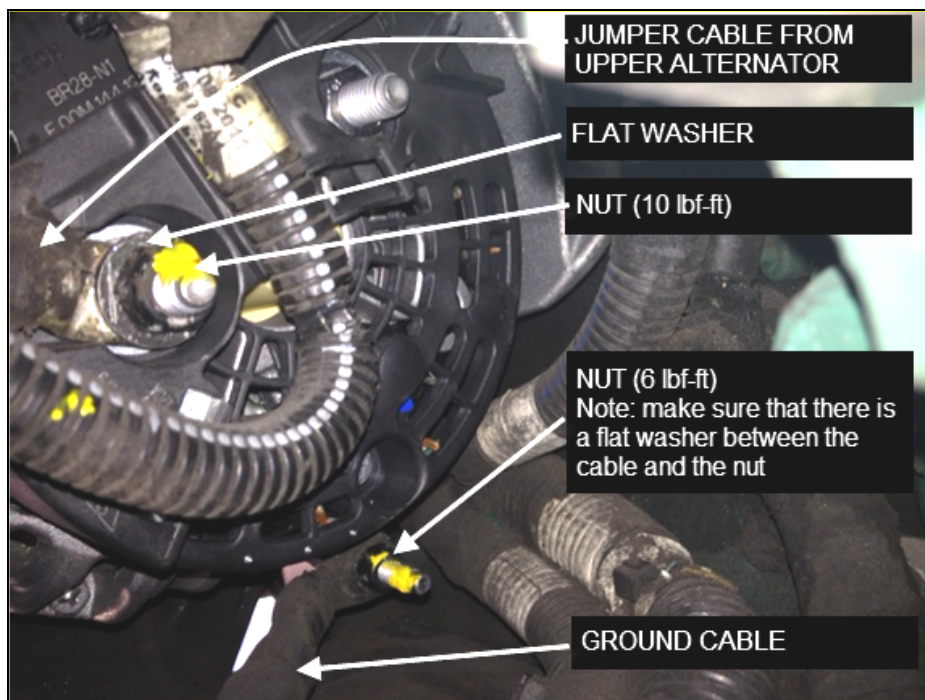

FIGURE 29

18. Plug lower alternator harness onto lower alternator connector and secure using two nylon cable ties #504637 (FIGURE 30).

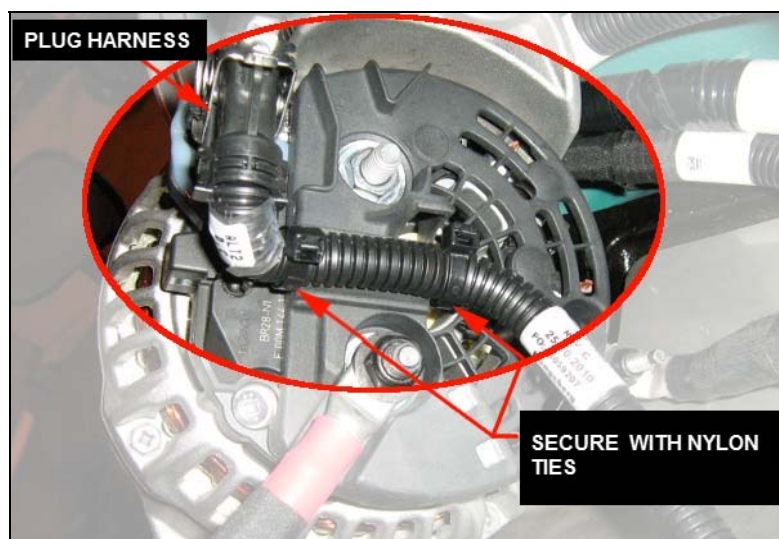

FIGURE 30

19. Apply anti-corrosion compound on alternator terminals and cable ring terminals or use color guard rubber coating #684013 if available.
20. Reinstall the A/C compressor idler pulley bracket assembly (FIGURE 31). Apply Loctite 243 on threads. Reinstall the A/C compressor belts.
21. Finally, check that all cables are properly installed, start engine and check for proper functioning. Check for proper functioning of charging system.

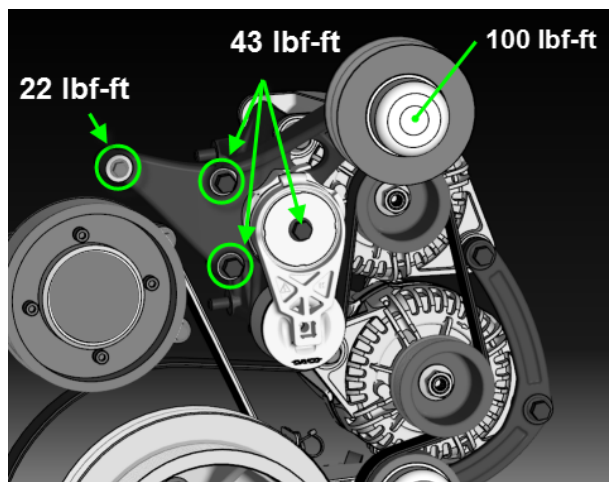

FIGURE 31

PARTS / WASTE DISPOSAL

Discard waste according to applicable environmental regulations (Municipal/State[Prov.]/ Federal)