

# PARTS KIT CATALOG



# Table of Contents

## Complete Brake Assemblies

- 7" Brake Kits .....2
- 10" Brake Kits .....4
- 12" Brake Kits .....11
- 12¼" Brake Kits .....20

## Brake Components

- Brake Controller, Actuators, Gaskets & Breakaway Kits.....36
- Brake Cylinder & Rebuild Kits.....38
- Caliper Replacement & Repair Kits .....41
- Magnet Kits.....43
- Brake Shoe & Lining Kits.....46
- Brake Block & Pad Kits .....59
- Miscellaneous Brake Hardware Kits .....61
- Brake Retrofit Kits.....69

## Complete Hub & Hub-Drum

- 7" Hub & Hub-Drum Kits (up to 2,200 Lbs.) .....74
- 10" Hub & Hub-Drum Kits (2,500 Lbs. to 4,400 Lbs.) .....76
- 12" Hub & Hub-Drum Kits (5,200 Lbs. to 7,000 Lbs.) .....81
- 12¼" Hub & Hub-Drum Kits (7,200 Lbs. to 15,000 Lbs.) .....86

## Hub Components

- Rotor Replacement Kits.....92
- Bearing Kits .....93
- E-Z Lube Components .....98
- Nev-R-Lube Components .....100
- Grease & Oil Caps.....101
- Hub Covers & Wheel Nut Covers .....103
- Seals.....106
- Wheel & Drum Mounting Hardware.....109
- Spindle Nuts & Washers Kits.....114
- Retainer Kit.....116

## Suspension Components

- Suspension Kits.....117
- Torflex Removable Spindle Option.....122
- Over/Under Conversion and Shock Kits .....123
- Miscellaneous Suspension Hardware .....124
- Airflex Kits.....130

## Dexter Limited Warranty and Video Gallery .....131-132

Dexter is owned by DexKo Global, formed at the end of 2015 by combining Dexter and AL-KO VT. This combination created a global leader in highly engineered trailer running gear components and systems, with over 130 years of trailer and caravan componentry experience.

DexKo Global is majority-owned by funds managed by The Sterling Group, an operationally focused middle market private equity firm based in Houston, Texas and managed out of Novi, Michigan by a strategic staff of executives focused on leveraging the resources of the combined companies. With enhanced scale, operating leverage, capital efficiencies and diversity, DexKo will deliver:

- Market leadership in product development and innovation
- Improved customer service through the sharing of technology and best practices
- Increased manufacturing flexibility
- Great efficiency through global sourcing



DexKo's ongoing focus is profitable growth across its entire footprint through outstanding customer service, product quality and innovation, operational efficiencies and accretive acquisitions. We'll maintain the unparalleled customer service and product quality that the market has come to trust in both Dexter and AL-KO VT.

Dexter uses a number of trusted trademarks to market its products in the United States, as well as internationally. All of those trademarks are protected by law, and, in addition, at least the following are registered:

Airflex®, Dexter®, E-Z Flex®, E-Z Lube®, GAL-DEX®, Nev-R-Adjust®, Nev-R-Lube®, Predator DX2®, Predator Series®, Torflex®

# Complete Brake Assemblies



## Brake Kit - LH

**K23-047-00**

Complete 7" x 1 1/4" electric brake assembly (2.2K).

Dx Part No.	Quantity	Parts Description
006-017-00	4	Nut, Hex
023-047-00	1	7" x 1 1/4" 2.2K Electric LH
059-726-00	1	Instruction Sheet



## Brake Kit - RH

**K23-048-00**

Complete 7" x 1 1/4" electric brake assembly (2.2K).

Dx Part No.	Quantity	Parts Description
006-017-00	4	Nut, Hex
023-048-00	1	7" x 1 1/4" 2.2K Electric RH
059-726-00	1	Instruction Sheet



## Brake Kit - LH

**K23-103-00**

Complete 7" x 1 1/4" electric with park brake assembly (2.2K).

Dx Part No.	Quantity	Parts Description
006-017-00	4	Nut, Hex
023-103-00	1	7" x 1 1/4" 2.2K Electric LH
059-726-00	1	Installation Sheet



## Brake Kit - RH

**K23-104-00**

Complete 7" x 1 1/4" electric with park brake assembly (2.2K).

Dx Part No.	Quantity	Parts Description
006-017-00	4	Nut, Hex
023-104-00	1	7" x 1 1/4" 2.2K Electric RH
059-726-00	1	Instruction Sheet



## Brake Kit - LH

**K23-398-00**

Complete 7" x 1 $\frac{3}{4}$ " hydraulic uni-servo brake assembly (2.2K).

Dx Part No.	Quantity	Parts Description
006-017-00	4	Nut, Hex
023-398-00	1	7" x 1 $\frac{3}{4}$ " 2.5K Hydraulic LH
059-726-00	1	Instruction Sheet



## Brake Kit - RH

**K23-399-00**

Complete 7" x 1 $\frac{3}{4}$ " hydraulic uni-servo brake assembly (2.2K).

Dx Part No.	Quantity	Parts Description
006-017-00	4	Nut, Hex
023-399-00	1	7" x 1 $\frac{3}{4}$ " 2.5K Hydraulic RH
059-726-00	1	Instruction Sheet



# Complete Brake Assemblies



## Brake Kit - LH

**K23-472-00**

Complete 10" x 1½" electric brake assembly (3K).

Dx Part No.	Quantity	Parts Description
006-017-00	4	Nut, Hex
023-472-00	1	10" x 1½" 3K Electric LH
059-726-00	1	Instruction Sheet



## Brake Kit - RH

**K23-473-00**

Complete 10" x 1½" electric brake assembly (3K).

Dx Part No.	Quantity	Parts Description
006-017-00	4	Nut, Hex
023-473-00	1	10" x 1½" 3K Electric RH
059-726-00	1	Instruction Sheet



## Brake Kit - LH

**K23-476-00**

Complete 10" x 1½" electric brake assembly (3K); Nev-R-Adjust.

Dx Part No.	Quantity	Parts Description
006-017-00	4	Nut, Hex
023-476-00	1	10" x 1½" 3K Electric LH
059-726-00	1	Instruction Sheet



## Brake Kit - RH

**K23-477-00**

Complete 10" x 1½" electric brake assembly (3K); Nev-R-Adjust.

Dx Part No.	Quantity	Parts Description
006-017-00	4	Nut, Hex
023-477-00	1	10" x 1½" 3K Electric RH
059-726-00	1	Instruction Sheet



## Brake Kit - LH

**K23-026-00**

Complete 10" x 2 1/4" electric brake assembly (3.5K).

Dx Part No.	Quantity	Parts Description
006-017-00	4	Nut, Hex
023-026-00	1	10" x 2 1/4" 3.5K Electric LH
046-007-00	2	Plug
059-726-00	1	Instruction Sheet



## Brake Kit - RH

**K23-027-00**

Complete 10" x 2 1/4" electric brake assembly (3.5K).

Dx Part No.	Quantity	Parts Description
006-017-00	4	Nut, Hex
023-027-00	1	10" x 2 1/4" 3.5K Electric RH
046-007-00	2	Plug
059-726-00	1	Instruction Sheet



## Brake Kit - LH

**K23-086-00**

Complete 10" x 2 1/4" electric brake with park brake assembly (3.5K).

Dx Part No.	Quantity	Parts Description
006-017-00	4	Nut, Hex
023-086-00	1	10" x 2 1/4" 3.5K Electric LH
046-007-00	2	Plug
059-726-00	1	Installation Sheet



## Brake Kit - RH

**K23-087-00**

Complete 10" x 2 1/4" electric brake with park brake assembly (3.5K).

Dx Part No.	Quantity	Parts Description
006-017-00	4	Nut, Hex
023-087-00	1	10" x 2 1/4" 3.5K Electric RH
046-007-00	2	Plug
059-726-00	1	Instruction Sheet



### Brake Kit - LH

**K23-468-00**

Complete 10" x 2 1/4" electric brake assembly (3.5K), Nev-R-Adjust.

Dx Part No.	Quantity	Parts Description
006-017-00	4	Nut, Hex
023-468-00	1	10" x 2 1/4" 3.5K Electric LH
046-007-00	2	Plug
059-726-00	1	Instruction Sheet



### Brake Kit - RH

**K23-469-00**

Complete 10" x 2 1/4" electric brake assembly (3.5K), Nev-R-Adjust.

Dx Part No.	Quantity	Parts Description
006-017-00	4	Nut, Hex
023-469-00	1	10" x 2 1/4" 3.5K Electric RH
046-007-00	2	Plug
059-726-00	1	Instruction Sheet



### Brake Kit - LH

**K23-310-00**

Complete 10" x 2 1/4" hydraulic duo-servo brake assembly (3.5K).

Dx Part No.	Quantity	Parts Description
006-017-00	4	Nut, Hex
023-310-00	1	10" x 2 1/4" 3.5K Hydraulic LH
046-007-00	2	Plug
059-726-00	1	Instruction Sheet



### Brake Kit - RH

**K23-311-00**

Complete 10" x 2 1/4" hydraulic duo-servo brake assembly (3.5K).

Dx Part No.	Quantity	Parts Description
006-017-00	4	Brake Mounting Nut
023-311-00	1	10" x 2 1/4" 3.5K Hydraulic RH
046-007-00	2	Plug
059-726-00	1	Instruction Sheet



## Brake Kit - LH

**K23-400-00**

Complete 10" x 2 1/4" hydraulic duo-servo with park brake assembly (3.5K).

Dx Part No.	Quantity	Parts Description
006-017-00	4	Nut, Hex
023-400-00	1	10" x 2 1/4" 3.5K Hydraulic LH
046-007-00	2	Plug
059-726-00	1	Instruction Sheet



## Brake Kit - RH

**K23-401-00**

Complete 10" x 2 1/4" hydraulic duo-servo with park brake assembly (3.5K).

Dx Part No.	Quantity	Parts Description
006-017-00	4	Nut, Hex
023-401-00	1	10" x 2 1/4" 3.5K Hydraulic RH
046-007-00	2	Plug
059-726-00	1	Instruction Sheet



## Brake Kit - LH

**K23-344-00**

Complete 10" x 2 1/4" hydraulic free backing brake assembly (3.5K).

Dx Part No.	Quantity	Parts Description
006-017-00	4	Nut, Hex
023-344-00	1	10" x 2 1/4" 3.5K Hydraulic LH
046-007-00	2	Plug
059-726-00	1	Instruction Sheet



## Brake Kit - RH

**K23-345-00**

Complete 10" x 2 1/4" hydraulic free backing brake assembly (3.5K).

Dx Part No.	Quantity	Parts Description
006-017-00	4	Nut, Hex
023-345-00	1	10" x 2 1/4" 3.5K Hydraulic RH
046-007-00	2	Plug
059-726-00	1	Instruction Sheet



# Complete Brake Assemblies



## Brake Kit - LH

**K23-344-01**

Complete 10" x 2 1/4" hydraulic free backing corrosion resistant brake assembly (3.5K).

Dx Part No.	Quantity	Parts Description
006-017-00	4	Nut, Hex
023-344-01	1	10" x 2 1/4" 3.5K Hydraulic LH
046-007-00	2	Plug
059-726-00	1	Instruction Sheet



## Brake Kit - RH

**K23-345-01**

Complete 10" x 2 1/4" hydraulic free backing corrosion resistant brake assembly (3.5K).

Dx Part No.	Quantity	Parts Description
006-017-00	4	Nut, Hex
023-345-01	1	10" x 2 1/4" 3.5K Hydraulic RH
046-007-00	2	Plug
059-726-00	1	Instruction Sheet



## Brake Kit - LH

**K23-312-00**

Complete 10" x 2 1/4" hydraulic uni-servo brake assembly (3.5K).

Dx Part No.	Quantity	Parts Description
006-017-00	4	Nut, Hex
023-312-00	1	10" x 2 1/4" 3.5K Hydraulic LH
046-007-00	2	Plug
059-726-00	1	Instruction Sheet



## Brake Kit - RH

**K23-313-00**

Complete 10" x 2 1/4" hydraulic uni-servo brake assembly (3.5K).

Dx Part No.	Quantity	Parts Description
006-017-00	4	Nut, Hex
023-313-00	1	10" x 2 1/4" 3.5K Hydraulic RH
046-007-00	2	Plug
059-726-00	1	Instruction Sheet



## Brake Kit - LH

**K23-330-00**

Complete 10" x 2¼" hydraulic uni-servo with park brake assembly (3.5K).

Dx Part No.	Quantity	Parts Description
006-017-00	4	Nut, Hex
023-330-00	1	10" x 2¼" 3.5K Hydraulic LH
046-007-00	2	Plug
059-726-00	1	Instruction Sheet



## Brake Kit - RH

**K23-331-00**

Complete 10" x 2¼" hydraulic uni-servo with park brake assembly (3.5K)

Dx Part No.	Quantity	Parts Description
006-017-00	4	Nut, Hex
023-331-00	1	10" x 2¼" 3.5K Hydraulic RH
046-007-00	1	Plug
059-726-00	1	Instruction Sheet



## Brake Kit - LH

**K23-454-00**

Complete 10" x 2¼" electric brake assembly (4.4K).

Dx Part No.	Quantity	Parts Description
006-207-00	4	Nut, Hex
023-454-00	1	10" x 2¼" 4.4K Electric LH
046-007-00	2	Plug
059-726-00	1	Instruction Sheet



## Brake Kit - RH

**K23-455-00**

Complete 10" x 2¼" electric brake assembly (4.4K).

Dx Part No.	Quantity	Parts Description
006-207-00	4	Nut, Hex
023-455-00	1	10" x 2¼" 4.4K Electric RH
046-007-00	2	Plug
059-726-00	1	Instruction Sheet

# Complete Brake Assemblies



## Brake Kit - LH

**K23-478-00**

Complete 10" x 2¼" electric brake assembly (4.4K), Nev-R-Adjust.

Dx Part No.	Quantity	Parts Description
006-207-00	4	Nut, Hex
023-478-00	1	10" x 2¼" 4.4K Electric LH
046-007-00	2	Plug
059-726-00	1	Instruction Sheet



## Brake Kit - RH

**K23-479-00**

Complete 10" x 2¼" electric brake assembly (4.4K), Nev-R-Adjust.

Dx Part No.	Quantity	Parts Description
006-207-00	4	Nut, Hex
023-479-00	1	10" x 2¼" 4.4K Electric RH
046-007-00	2	Plug
059-726-00	1	Instruction Sheet



## Brake Kit - LH

**K23-462-00**

Complete 10" x 2¼" electric brake assembly (4.4K), Nev-R-Adjust (after 5/1/09).

Dx Part No.	Quantity	Parts Description
006-207-00	4	Nut, Hex
023-462-00	1	10" x 2¼" 4.4K Electric LH
046-007-00	2	Plug
059-726-00	1	Instruction Sheet



## Brake Kit - RH

**K23-463-00**

Complete 10" x 2¼" electric brake assembly (4.4K), Nev-R-Adjust (after 5/1/09).

Dx Part No.	Quantity	Parts Description
006-207-00	4	Nut, Hex
023-463-00	1	10" x 2¼" 4.4K Electric RH
046-007-00	2	Plug
059-726-00	1	Instruction Sheet



## Brake Kit - LH

**K23-105-00**

Complete 12" x 2" electric brake assembly (6K).

Dx Part No.	Quantity	Parts Description
006-193-00	5	Nut, Hex
023-105-00	1	12" x 2" 6K Electric LH
046-007-00	2	Plug
059-726-00	1	Instruction Sheet



## Brake Kit - RH

**K23-106-00**

Complete 12" x 2" 6K electric brake assembly (6K).

Dx Part No.	Quantity	Parts Description
006-193-00	5	Nut, Hex
023-106-00	1	12" x 2" 6K Electric RH
046-007-00	2	Plug
059-726-00	1	Instruction Sheet



## Brake Kit - LH

**K23-112-00**

Complete 12" x 2" electric brake assembly with park (6K).

Dx Part No.	Quantity	Parts Description
006-193-00	5	Nut, Hex
023-112-00	1	12" x 2" 6K Electric LH
046-007-00	2	Plug
059-726-00	1	Instruction Sheet



## Brake Kit - RH

**K23-113-00**

Complete 12" x 2" electric brake assembly with park (6K).

Dx Part No.	Quantity	Parts Description
006-193-00	5	Nut, Hex
023-113-00	1	12" x 2" 6K Electric RH
046-007-00	2	Plug
059-726-00	1	Instruction Sheet



# Complete Brake Assemblies



## Brake Kit - LH

**K23-458-00**

Complete 12" x 2" electric brake assembly (6K), Nev-R-Adjust.

Dx Part No.	Quantity	Parts Description
006-193-00	5	Nut, Hex
023-458-00	1	12" x 2" 6K Electric LH
046-007-00	2	Plug
059-726-00	1	Instruction Sheet



## Brake Kit - RH

**K23-459-00**

Complete 12" x 2" electric brake assembly (6K), Nev-R-Adjust.

Dx Part No.	Quantity	Parts Description
006-193-00	5	Nut, Hex
023-459-00	1	12" x 2" 6K Electric RH
046-007-00	2	Plug
059-726-00	1	Instruction Sheet



## Brake Kit - LH

**K23-180-00**

Complete 12" x 2" electric brake assembly (7K).

Dx Part No.	Quantity	Parts Description
006-193-00	5	Nut, Hex
023-180-00	1	12" x 2" 7K Electric LH
046-007-00	2	Plug
059-726-00	1	Instruction Sheet



## Brake Kit - RH

**K23-181-00**

Complete 12" x 2" electric brake assembly (7K).

Dx Part No.	Quantity	Parts Description
006-193-00	5	Nut, Hex
023-181-00	1	12" x 2" 7K Electric RH
046-007-00	2	Plug
059-726-00	1	Instruction Sheet



## Brake Kit - LH

**K23-464-00**

Complete 12" x 2" electric brake assembly (7K), Nev-R-Adjust.

Dx Part No.	Quantity	Parts Description
006-193-00	5	Nut, Hex
023-464-00	1	12" x 2" 7K Electric LH
046-007-00	2	Plug
059-726-00	1	Instruction Sheet



## Brake Kit - RH

**K23-465-00**

Complete 12" x 2" electric brake assembly (7K), Nev-R-Adjust.

Dx Part No.	Quantity	Parts Description
006-193-00	5	Nut, Hex
023-465-00	1	12" x 2" 7K Electric RH
046-007-00	2	Plug
059-726-00	1	Instruction Sheet



## Brake Kit - LH

**K23-322-00**

Complete 12" x 2" hydraulic duo-servo brake assembly (5.2K).

Dx Part No.	Quantity	Parts Description
006-193-00	5	Nut, Hex
023-322-00	1	12" x 2" 5.2K Hydraulic LH
046-007-00	2	Plug
059-726-00	1	Instruction Sheet



## Brake Kit - RH

**K23-323-00**

Complete 12" x 2" hydraulic duo-servo brake assembly (5.2K).

Dx Part No.	Quantity	Parts Description
006-193-00	5	Nut, Hex
023-323-00	1	12" x 2" 5.2K Hydraulic RH
046-007-00	2	Plug
059-726-00	1	Instruction Sheet

# Complete Brake Assemblies



## Brake Kit - LH

**K23-318-00**

Complete 12" x 2" hydraulic duo-servo with park brake assembly (5.2K).

Dx Part No.	Quantity	Parts Description
006-193-00	5	Nut, Hex
023-318-00	1	12" x 2" 5.2K Hydraulic LH
046-007-00	2	Plug
059-726-00	1	Instruction Sheet



## Brake Kit - RH

**K23-319-00**

Complete 12" x 2" hydraulic duo-servo with park brake assembly (5.2K).

Dx Part No.	Quantity	Parts Description
006-193-00	5	Nut, Hex
023-319-00	1	12" x 2" 5.2K Hydraulic RH
046-007-00	2	Plug
059-726-00	1	Instruction Sheet



## Brake Kit - LH

**K23-324-00**

Complete 12" x 2" hydraulic uni-servo brake assembly (5.2K).

Dx Part No.	Quantity	Parts Description
006-193-00	5	Nut, Hex
023-324-00	1	12" x 2" 5.2K Hydraulic LH
046-007-00	2	Plug
059-726-00	1	Instruction Sheet



## Brake Kit - RH

**K23-325-00**

Complete 12" x 2" hydraulic uni-servo brake assembly (5.2K).

Dx Part No.	Quantity	Parts Description
006-193-00	5	Nut, Hex
023-325-00	1	12" x 2" 5.2K Hydraulic RH
046-007-00	2	Plug
059-726-00	1	Instruction Sheet



## Brake Kit - LH

**K23-320-00**

Complete 12" x 2" hydraulic uni-servo with park brake assembly (5.2K).

Dx Part No.	Quantity	Parts Description
006-193-00	5	Nut, Hex
023-320-00	1	12" x 2" 5.2K Hydraulic LH
046-007-00	2	Plug
059-726-00	1	Instruction Sheet



## Brake Kit - RH

**K23-321-00**

Complete 12" x 2" hydraulic uni-servo with park brake assembly (5.2K).

Dx Part No.	Quantity	Parts Description
006-193-00	5	Nut, Hex
023-321-00	1	12" x 2" 5.2K Hydraulic RH
046-007-00	2	Plug
059-726-00	1	Instruction Sheet



## Brake Kit - LH

**K23-336-00**

Complete 12" x 2" hydraulic duo-servo brake assembly (7K).

Dx Part No.	Quantity	Parts Description
006-193-00	5	Nut, Hex
023-336-00	1	12" x 2" 7K Hydraulic LH
046-007-00	2	Plug
059-726-00	1	Instruction Sheet



## Brake Kit - RH

**K23-337-00**

Complete 12" x 2" hydraulic duo-servo brake assembly (7K).

Dx Part No.	Quantity	Parts Description
006-193-00	5	Nut, Hex
023-337-00	1	12" x 2" 7K Hydraulic RH
046-007-00	2	Plug
059-726-00	1	Instruction Sheet



# Complete Brake Assemblies



## Brake Kit - LH

**K23-332-00**

Complete 12" x 2" hydraulic duo-servo with park brake assembly (7K).

Dx Part No.	Quantity	Parts Description
006-193-00	5	Nut, Hex
023-332-00	1	12" x 2" 7K Hydraulic LH
046-007-00	2	Plug
059-726-00	1	Instruction Sheet



## Brake Kit - RH

**K23-333-00**

Complete 12" x 2" hydraulic duo-servo with park brake assembly (7K).

Dx Part No.	Quantity	Parts Description
006-193-00	5	Nut, Hex
023-333-00	1	12" x 2" 7K Hydraulic RH
046-007-00	2	Plug
059-726-00	1	Instruction Sheet



## Brake Kit - LH

**K23-338-00**

Complete 12" x 2" hydraulic uni-servo brake assembly (7K).

Dx Part No.	Quantity	Parts Description
006-193-00	5	Nut, Hex
023-338-00	1	12" x 2" 7K Hydraulic LH
046-007-00	2	Plug
059-726-00	1	Instruction Sheet



## Brake Kit - RH

**K23-339-00**

Complete 12" x 2" hydraulic uni-servo brake assembly (7K).

Dx Part No.	Quantity	Parts Description
006-193-00	5	Nut, Hex
023-339-00	1	12" x 2" 7K Hydraulic RH
046-007-00	2	Plug
059-726-00	1	Instruction Sheet



## Brake Kit - LH

**K23-334-00**

Complete 12" x 2" hydraulic uni-servo with park brake assembly (7K).

Dx Part No.	Quantity	Parts Description
006-193-00	5	Nut, Hex
023-334-00	1	12" x 2" 7K Hydraulic LH
046-007-00	2	Plug
059-726-00	1	Instruction Sheet



## Brake Kit - RH

**K23-335-00**

Complete 12" x 2" hydraulic uni-servo with park brake assembly (7K).

Dx Part No.	Quantity	Parts Description
006-193-00	5	Nut, Hex
023-335-00	1	12" x 2" 7K Hydraulic RH
046-007-00	2	Plug
059-726-00	1	Instruction Sheet



## Brake Kit - LH

**K23-342-00**

Complete 12" x 2" hydraulic free backing brake assembly (7K).

Dx Part No.	Quantity	Parts Description
006-193-00	5	Nut, Hex
023-342-00	1	12" x 2" 7K Hydraulic LH
046-007-00	2	Plug
059-726-00	1	Instruction Sheet



## Brake Kit - RH

**K23-343-00**

Complete 12" x 2" hydraulic free backing brake assembly (7K).

Dx Part No.	Quantity	Parts Description
006-193-00	5	Nut, Hex
023-343-00	1	12" x 2" 7K Hydraulic RH
046-007-00	2	Plug
059-726-00	1	Instruction Sheet

# Complete Brake Assemblies



## Brake Kit - LH

**K23-340-00**

Complete 12" x 2" hydraulic free backing with park brake assembly (7K).

Dx Part No.	Quantity	Parts Description
006-193-00	5	Nut, Hex
023-340-00	1	12" x 2" 7K Hydraulic LH
046-007-00	2	Plug
059-726-00	1	Instruction Sheet



## Brake Kit - RH

**K23-341-00**

Complete 12" x 2" hydraulic free backing with park brake assembly (7K).

Dx Part No.	Quantity	Parts Description
006-193-00	5	Nut, Hex
023-341-00	1	12" x 2" 7K Hydraulic RH
046-007-00	2	Plug
059-726-00	1	Instruction Sheet



## Brake Kit - LH

**K23-340-01**

Complete 12" x 2" hydraulic free backing with park, corrosion resistant brake assembly (7K).

Dx Part No.	Quantity	Parts Description
006-193-00	5	Nut, Hex
023-340-01	1	12" x 2" 7K Hydraulic LH
046-007-00	2	Plug
059-726-00	1	Instruction Sheet



## Brake Kit - RH

**K23-341-01**

Complete 12" x 2" hydraulic free backing with park, corrosion resistant brake assembly (7K).

Dx Part No.	Quantity	Parts Description
006-193-00	5	Nut, Hex
023-341-01	1	12" x 2" 7K Hydraulic RH
046-007-00	2	Plug
059-726-00	1	Instruction Sheet



## Brake Kit - LH

**K23-342-01**

Complete 12" x 2" hydraulic free backing corrosion resistant brake assembly (7K).

Dx Part No.	Quantity	Parts Description
006-193-00	5	Nut, Hex
023-342-01	1	12" x 2" 7K Hydraulic LH
046-007-00	2	Plug
059-726-00	1	Instruction Sheet



## Brake Kit - RH

**K23-343-01**

Complete 12" x 2" hydraulic free backing corrosion resistant brake assembly (7K).

Dx Part No.	Quantity	Parts Description
006-193-00	5	Nut, Hex
023-343-01	1	12" x 2" 7K Hydraulic RH
046-007-00	2	Plug
059-726-00	1	Instruction Sheet

# Complete Brake Assemblies



## Brake Kit - LH

**K23-428-00**

Complete 12 1/4" x 2 1/2" electric manual adjust brake assembly (7.2K).

Dx Part No.	Quantity	Parts Description
023-428-00	1	12 1/4" x 2 1/2" 7.2K Electric LH
059-637-00	1	Instruction Sheet



## Brake Kit - RH

**K23-429-00**

Complete 12 1/4" x 2 1/2" electric manual adjust brake assembly (7.2K).

Dx Part No.	Quantity	Parts Description
023-429-00	1	12 1/4" x 2 1/2" 7.2K Electric RH
059-637-00	1	Instruction Sheet



## Brake Kit - LH

**K23-434-00**

Complete 12 1/4" x 3 3/8" electric forward self-adjust brake assembly (8K).

Dx Part No.	Quantity	Parts Description
023-434-00	1	12 1/4" x 3 3/8" 8K Electric LH
059-637-00	1	Instruction Sheet



## Brake Kit - RH

**K23-435-00**

Complete 12 1/4" x 3 3/8" electric forward self-adjust brake assembly (8K).

Dx Part No.	Quantity	Parts Description
023-435-00	1	12 1/4" x 3 3/8" 8K Electric RH
059-637-00	1	Instruction Sheet





## Brake Kit - LH

**K23-432-00**

Complete 12 1/4" x 3 3/8" electric manual adjust brake assembly (8K).

Dx Part No.	Quantity	Parts Description
023-432-00	1	12 1/4" x 3 3/8" 8K Electric LH
059-637-00	1	Instruction Sheet



## Brake Kit - RH

**K23-433-00**

Complete 12 1/4" x 3 3/8" electric manual adjust brake assembly (8K).

Dx Part No.	Quantity	Parts Description
023-433-00	1	12 1/4" x 3 3/8" 8K Electric RH
059-637-00	1	Instruction Sheet

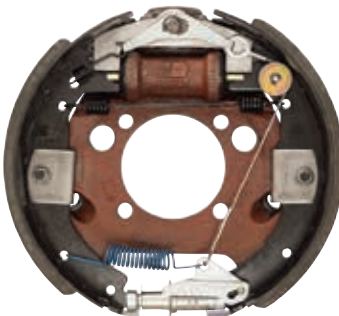

## Brake Kit - LH

**K23-402-00**

Complete 12 1/4" x 3 3/8" hydraulic duo-servo forward self-adjust brake assembly (8K).

Dx Part No.	Quantity	Parts Description
023-402-00	1	12 1/4" x 3 3/8" 8K Hydraulic LH
059-637-00	1	Instruction Sheet



## Brake Kit - RH

**K23-403-00**

Complete 12 1/4" x 3 3/8" hydraulic duo-servo forward self-adjust brake assembly (8K).

Dx Part No.	Quantity	Parts Description
023-403-00	1	12 1/4" x 3 3/8" 8K Hydraulic RH
059-637-00	1	Instruction Sheet

# Complete Brake Assemblies



## Brake Kit - LH

**K23-420-00**

Complete 12 1/4" x 3 3/8" hydraulic duo-servo forward self-adjust corrosion resistant brake assembly (8K).

Dx Part No.	Quantity	Parts Description
023-420-00	1	12 1/4" x 3 3/8" 8K Hydraulic LH
059-637-00	1	Instruction Sheet



## Brake Kit - RH

**K23-421-00**

Complete 12 1/4" x 3 3/8" hydraulic duo-servo forward self-adjust corrosion resistant brake assembly (8K)

Dx Part No.	Quantity	Parts Description
023-421-00	1	12 1/4" x 3 3/8" 8K Hydraulic RH
059-637-00	1	Instruction Sheet



## Brake Kit - LH

**K23-171-00**

Complete 12 1/4" x 3 3/8" hydraulic duo-servo rear self-adjust with park brake assembly (8K).

Dx Part No.	Quantity	Parts Description
023-171-00	1	12 1/4" x 3 3/8" 8K Hydraulic LH
059-637-00	1	Instruction Sheet



## Brake Kit - RH

**K23-172-00**

Complete 12 1/4" x 3 3/8" hydraulic duo-servo rear self-adjust with park brake assembly (8K).

Dx Part No.	Quantity	Parts Description
023-172-00	1	12 1/4" x 3 3/8" 8K Hydraulic RH
059-637-00	1	Instruction Sheet



## Brake Kit - LH

**K23-388-00**

Complete 12 1/4" x 3 3/8" hydraulic duo-servo manual adjust brake assembly (8K).

Dx Part No.	Quantity	Parts Description
023-388-00	1	12 1/4" x 3 3/8" 8K Hydraulic LH
059-637-00	1	Instruction Sheet



## Brake Kit - RH

**K23-387-00**

Complete 12 1/4" x 3 3/8" hydraulic duo-servo manual adjust brake assembly (8K).

Dx Part No.	Quantity	Parts Description
023-387-00	1	12 1/4" x 3 3/8" 8K Hydraulic RH
059-637-00	1	Instruction Sheet

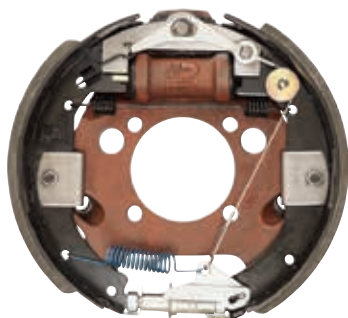

## Brake Kit - LH

**K23-418-00**

Complete 12 1/4" x 3 3/8" hydraulic uni-servo forward self-adjust brake assembly (8K).

Dx Part No.	Quantity	Parts Description
023-418-00	1	12 1/4" x 3 3/8" 8K Hydraulic LH
059-637-00	1	Instruction Sheet

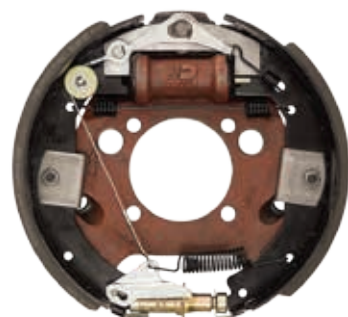

## Brake Kit - RH

**K23-419-00**

Complete 12 1/4" x 3 3/8" hydraulic uni-servo forward self-adjust brake assembly (8K).

Dx Part No.	Quantity	Parts Description
023-419-00	1	12 1/4" x 3 3/8" 8K Hydraulic RH
059-637-00	1	Instruction Sheet

# Complete Brake Assemblies



## Brake Kit - LH

**K23-252-00**

Complete 12 1/4" x 3 3/8" hydraulic uni-servo manual adjust with park brake assembly (8K).

Dx Part No.	Quantity	Parts Description
023-252-00	1	12 1/4" x 3 3/8" 8K Hydraulic LH
059-637-00	1	Instruction Sheet



## Brake Kit - RH

**K23-253-00**

Complete 12 1/4" x 3 3/8" hydraulic uni-servo manual adjust with park brake assembly (8K).

Dx Part No.	Quantity	Parts Description
023-253-00	1	12 1/4" x 3 3/8" 8K Hydraulic RH
059-637-00	1	Instruction Sheet



## Brake Kit - LH

**K23-450-00**

Complete 12 1/4" x 3 3/8" electric forward self-adjust brake assembly (9-10K general duty).

Dx Part No.	Quantity	Parts Description
023-450-00	1	12 1/4" x 3 3/8" 9K-10K GD Electric LH
059-637-00	1	Instruction Sheet

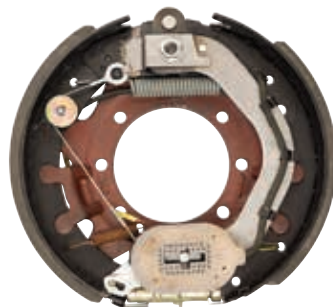

## Brake Kit - RH

**K23-451-00**

Complete 12 1/4" x 3 3/8" electric forward self-adjust brake assembly (9-10K general duty).

Dx Part No.	Quantity	Parts Description
023-451-00	1	12 1/4" x 3 3/8" 9K-10K GD Electric RH
059-637-00	1	Instruction Sheet



## Brake Kit - LH

**K23-448-00**

Complete 12 1/4" x 3 3/8" electric manual adjust brake assembly (9K-10K general duty).

Dx Part No.	Quantity	Parts Description
023-448-00	1	12 1/4" x 3 3/8" 9K-10K GD Electric LH
059-637-00	1	Instruction Sheet



## Brake Kit - RH

**K23-449-00**

Complete 12 1/4" x 3 3/8" electric manual adjust brake assembly (9K-10K general duty).

Dx Part No.	Quantity	Parts Description
023-449-00	1	12 1/4" x 3 3/8" 9K-10K GD Electric RH
059-637-00	1	Instruction Sheet

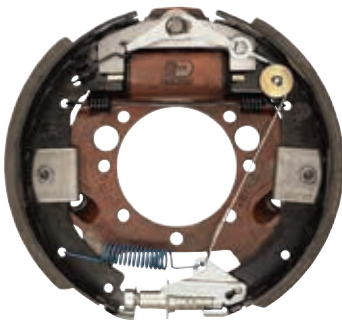

## Brake Kit - LH

**K23-410-00**

Complete 12 1/4" x 3 3/8" hydraulic duo-servo forward self-adjust brake assembly (9K-10K general duty).

Dx Part No.	Quantity	Parts Description
023-410-00	1	12 1/4" x 3 3/8" 9K-10K GD Hydraulic LH
059-637-00	1	Instruction Sheet

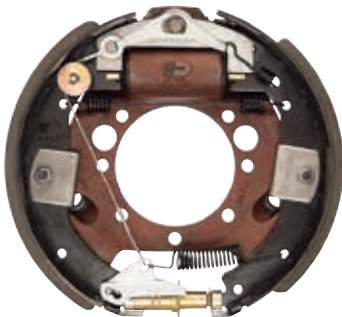

## Brake Kit - RH

**K23-411-00**

Complete 12 1/4" x 3 3/8" hydraulic duo-servo forward self-adjust brake assembly (9K-10K general duty).

Dx Part No.	Quantity	Parts Description
023-411-00	1	12 1/4" x 3 3/8" 9K-10K GD Hydraulic RH
059-637-00	1	Instruction Sheet



# Complete Brake Assemblies



## Brake Kit - LH

**K23-210-00**

Complete 12 1/4" x 3 3/8" hydraulic duo-servo rear self-adjust with park brake assembly (9K-10K general duty).

Dx Part No.	Quantity	Parts Description
023-210-00	1	12 1/4" x 3 3/8" 9K-10K GD Hydraulic LH
059-637-00	1	Instruction Sheet



## Brake Kit - RH

**K23-211-00**

Complete 12 1/4" x 3 3/8" hydraulic duo-servo rear self-adjust with park brake assembly (9K-10K general duty).

Dx Part No.	Quantity	Parts Description
023-211-00	1	12 1/4" x 3 3/8" 9K-10K GD Hydraulic RH
059-637-00	1	Instruction Sheet

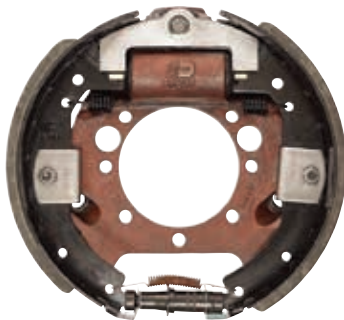

## Brake Kit - LH

**K23-396-00**

Complete 12 1/4" x 3 3/8" hydraulic duo-servo manual adjust brake assembly (9K-10K general duty).

Dx Part No.	Quantity	Parts Description
023-396-00	1	12 1/4" x 3 3/8" 9K-10K GD Hydraulic LH
059-637-00	1	Instruction Sheet

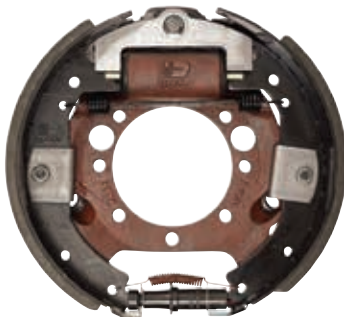

## Brake Kit - RH

**K23-395-00**

Complete 12 1/4" x 3 3/8" hydraulic duo-servo manual adjust brake assembly (9K-10K general duty).

Dx Part No.	Quantity	Parts Description
023-395-00	1	12 1/4" x 3 3/8" 9K-10K GD Hydraulic RH
059-637-00	1	Instruction Sheet

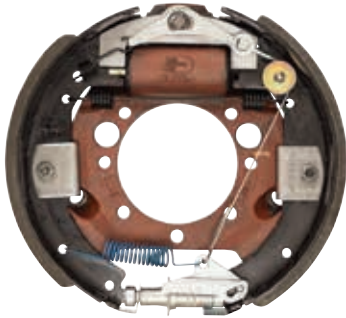

## Brake Kit - LH

**K23-412-00**

Complete 12 1/4" x 3 3/8" hydraulic uni-servo forward self-adjust brake assembly (9K-10K general duty).

Dx Part No.	Quantity	Parts Description
023-412-00	1	12 1/4" x 3 3/8" 9K-10K GD Hydraulic LH
059-637-00	1	Instruction Sheet

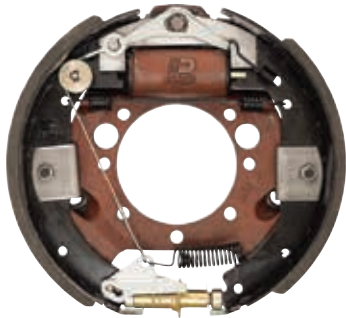

## Brake Kit - RH

**K23-413-00**

Complete 12 1/4" x 3 3/8" hydraulic uni-servo forward self-adjust brake assembly (9K-10K general duty).

Dx Part No.	Quantity	Parts Description
023-413-00	1	12 1/4" x 3 3/8" 9K-10K GD Hydraulic RH
059-637-00	1	Instruction Sheet



## Brake Kit - LH

**K23-234-00**

Complete 12 1/4" x 3 3/8" hydraulic uni-servo manual adjust with park brake assembly (9K-10K general duty).

Dx Part No.	Quantity	Parts Description
023-234-00	1	12 1/4" x 3 3/8" 9K-10K GD Hydraulic LH
059-637-00	1	Instruction Sheet



## Brake Kit - RH

**K23-235-00**

Complete 12 1/4" x 3 3/8" hydraulic uni-servo manual adjust with park brake assembly (9K-10K general duty).

Dx Part No.	Quantity	Parts Description
023-235-00	1	12 1/4" x 3 3/8" 9K-10K GD Hydraulic RH
059-637-00	1	Instruction Sheet

# Complete Brake Assemblies



## Brake Kit - LH

**K23-438-00**

Complete 12 1/4" x 4" electric forward self-adjust brake assembly (10K heavy duty).

Dx Part No.	Quantity	Parts Description
023-438-00	1	12 1/4" x 4" 10K Electric LH
059-637-00	1	Instruction Sheet



## Brake Kit - RH

**K23-439-00**

Complete 12 1/4" x 4" electric forward self-adjust brake assembly (10K heavy duty).

Dx Part No.	Quantity	Parts Description
023-439-00	1	12 1/4" x 4" 10K Electric RH
059-637-00	1	Instruction Sheet



## Brake Kit - LH

**K23-436-00**

Complete 12 1/4" x 4" electric manual adjust brake assembly (10K heavy duty).

Dx Part No.	Quantity	Parts Description
023-436-00	1	12 1/4" x 4" 10K Electric LH
059-637-00	1	Instruction Sheet



## Brake Kit - RH

**K23-437-00**

Complete 12 1/4" x 4" electric manual adjust brake assembly (10K heavy duty).

Dx Part No.	Quantity	Parts Description
023-437-00	1	12 1/4" x 4" 10K Electric RH
059-637-00	1	Instruction Sheet

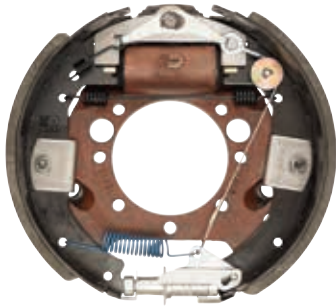

## Brake Kit - LH

**K23-404-00**

Complete 12 1/4" x 4" hydraulic duo-servo forward self-adjust brake assembly (10K heavy duty).

Dx Part No.	Quantity	Parts Description
023-404-00	1	12 1/4" x 4" 10K Hydraulic LH
059-637-00	1	Instruction Sheet

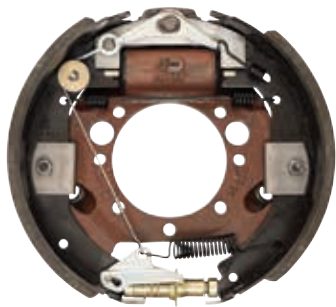

## Brake Kit - RH

**K23-405-00**

Complete 12 1/4" x 4" hydraulic duo-servo forward self-adjust brake assembly (10K heavy duty).

Dx Part No.	Quantity	Parts Description
023-405-00	1	12 1/4" x 4" 10K Hydraulic RH
059-637-00	1	Instruction Sheet



## Brake Kit - LH

**K23-168-00**

Complete 12 1/4" x 4" hydraulic duo-servo rear self-adjust with park brake assembly (10K heavy duty).

Dx Part No.	Quantity	Parts Description
023-168-00	1	12 1/4" x 4" 10K Hydraulic LH
059-637-00	1	Instruction Sheet



## Brake Kit - RH

**K23-169-00**

Complete 12 1/4" x 4" hydraulic duo-servo rear self-adjust with park brake assembly (10K heavy duty).

Dx Part No.	Quantity	Parts Description
023-169-00	1	12 1/4" x 4" 10K Hydraulic RH
059-637-00	1	Instruction Sheet

# Complete Brake Assemblies

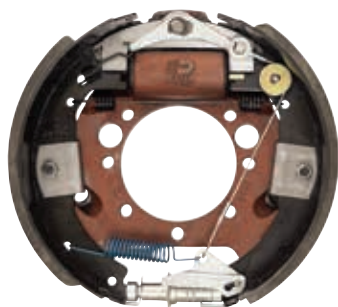

## Brake Kit - LH

**K23-414-00**

Complete 12 1/4" x 4" hydraulic uni-servo forward self-adjust brake assembly (10K heavy duty).

Dx Part No.	Quantity	Parts Description
023-414-00	1	12 1/4" x 4" 10K Hydraulic LH
059-637-00	1	Instruction Sheet



## Brake Kit - RH

**K23-415-00**

Complete 12 1/4" x 4" hydraulic uni-servo forward self-adjust brake assembly (10K heavy duty).

Dx Part No.	Quantity	Parts Description
023-415-00	1	12 1/4" x 4" 10K Hydraulic RH
059-637-00	1	Instruction Sheet

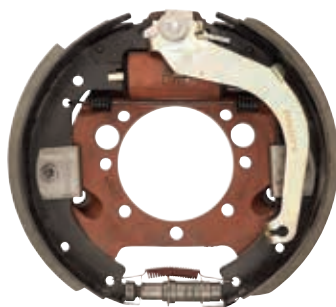

## Brake Kit - LH

**K23-222-00**

Complete 12 1/4" x 4" hydraulic uni-servo manual adjust with park brake assembly (10K heavy duty).

Dx Part No.	Quantity	Parts Description
023-222-00	1	12 1/4" x 4" 10K Hydraulic LH
059-637-00	1	Instruction Sheet



## Brake Kit - RH

**K23-223-00**

Complete 12 1/4" x 4" hydraulic uni-servo manual adjust with park brake assembly (10K heavy duty).

Dx Part No.	Quantity	Parts Description
023-223-00	1	12 1/4" x 4" 10K Hydraulic RH
059-637-00	1	Instruction Sheet





## Brake Kit - LH

**K23-442-00**

Complete 12 1/4" x 5" electric forward self-adjust brake assembly (12K).

Dx Part No.	Quantity	Parts Description
023-442-00	1	12 1/4" x 5" 12K Electric LH
059-637-00	1	Instruction Sheet



## Brake Kit - RH

**K23-443-00**

Complete 12 1/4" x 5" electric forward self-adjust brake assembly (12K).

Dx Part No.	Quantity	Parts Description
023-443-00	1	12 1/4" x 5" 12K Electric RH
059-637-00	1	Instruction Sheet



## Brake Kit - LH

**K23-440-00**

Complete 12 1/4" x 5" electric manual adjust brake assembly (12K).

Dx Part No.	Quantity	Parts Description
023-440-00	1	12 1/4" x 5" 12K Electric LH
059-637-00	1	Instruction Sheet



## Brake Kit - RH

**K23-441-00**

Complete 12 1/4" x 5" electric manual adjust brake assembly (12K).

Dx Part No.	Quantity	Parts Description
023-441-00	1	12 1/4" x 5" 12K Electric RH
059-637-00	1	Instruction Sheet

# Complete Brake Assemblies

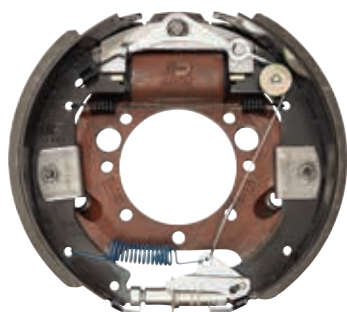

## Brake Kit - LH

**K23-408-00**

Complete 12 1/4" x 5" hydraulic duo-servo forward self-adjust brake assembly (12K).

Dx Part No.	Quantity	Parts Description
023-408-00	1	12 1/4" x 5" 12K Hydraulic LH
059-637-00	1	Instruction Sheet



## Brake Kit - RH

**K23-409-00**

Complete 12 1/4" x 5" hydraulic duo-servo forward self-adjust brake assembly (12K).

Dx Part No.	Quantity	Parts Description
023-409-00	1	12 1/4" x 5" 12K Hydraulic RH
059-637-00	1	Instruction Sheet



## Brake Kit - LH

**K23-165-00**

Complete 12 1/4" x 5" hydraulic duo-servo rear self-adjust with park brake assembly (12K).

Dx Part No.	Quantity	Parts Description
023-165-00	1	12 1/4" x 5" 12K Hydraulic LH
059-637-00	1	Instruction Sheet



## Brake Kit - RH

**K23-166-00**

Complete 12 1/4" x 5" hydraulic duo-servo rear self-adjust with park brake assembly (12K).

Dx Part No.	Quantity	Parts Description
023-166-00	1	12 1/4" x 5" 12K Hydraulic RH
059-637-00	1	Instruction Sheet

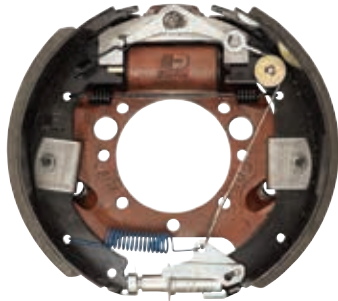

## Brake Kit - LH

**K23-416-00**

Complete 12 1/4" x 5" hydraulic uni-servo forward self-adjust brake assembly (12K).

Dx Part No.	Quantity	Parts Description
023-416-00	1	12 1/4" x 5" 12K Hydraulic LH
059-637-00	1	Instruction Sheet

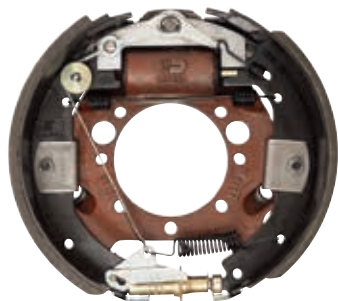

## Brake Kit - RH

**K23-417-00**

Complete 12 1/4" x 5" hydraulic uni-servo forward self-adjust brake assembly (12K).

Dx Part No.	Quantity	Parts Description
023-417-00	1	12 1/4" x 5" 12K Hydraulic RH
059-637-00	1	Instruction Sheet



## Brake Kit - LH

**K23-228-00**

Complete 12 1/4" x 5" hydraulic uni-servo manual adjust with park brake assembly (12K).

Dx Part No.	Quantity	Parts Description
023-228-00	1	12 1/4" x 5" 12K Hydraulic LH
059-637-00	1	Instruction Sheet

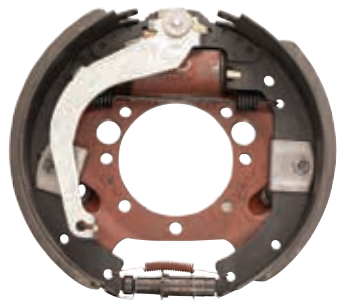

## Brake Kit - RH

**K23-229-00**

Complete 12 1/4" x 5" hydraulic uni-servo manual adjust with park brake assembly (12K).

Dx Part No.	Quantity	Parts Description
023-229-00	1	12 1/4" x 5" 12K Hydraulic RH
059-637-00	1	Instruction Sheet

# Complete Brake Assemblies



## Brake Kit - LH

**K23-446-00**

Complete 12 1/4" x 5" electric forward self-adjust brake assembly (15K).

Dx Part No.	Quantity	Parts Description
023-446-00	1	12 1/4" x 5" 15K Electric LH
059-637-00	1	Instruction Sheet



## Brake Kit - RH

**K23-447-00**

Complete 12 1/4" x 5" electric forward self-adjust brake assembly (15K).

Dx Part No.	Quantity	Parts Description
023-447-00	1	12 1/4" x 5" 15K Electric RH
059-637-00	1	Instruction Sheet



## Brake Kit - LH

**K23-444-00**

Complete 12 1/4" x 5" electric manual adjust brake assembly (15K).

Dx Part No.	Quantity	Parts Description
023-444-00	1	12 1/4" x 5" 15K Electric LH
059-637-00	1	Instruction Sheet



## Brake Kit - RH

**K23-445-00**

Complete 12 1/4" x 5" electric manual adjust brake assembly (15K).

Dx Part No.	Quantity	Parts Description
023-445-00	1	12 1/4" x 5" 15K Electric RH
059-637-00	1	Instruction Sheet

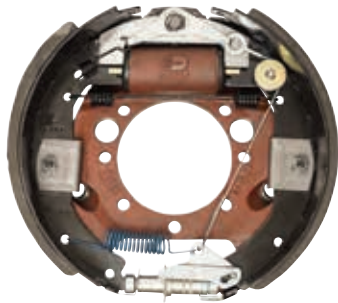

## Brake Kit - LH

**K23-406-00**

Complete 12 1/4" x 5" hydraulic duo-servo forward self-adjust brake assembly (15K).

Dx Part No.	Quantity	Parts Description
023-406-00	1	12 1/4" x 5" 15K Hydraulic LH
059-637-00	1	Instruction Sheet



## Brake Kit - RH

**K23-407-00**

Complete 12 1/4" x 5" hydraulic duo-servo forward self-adjust brake assembly (15K).

Dx Part No.	Quantity	Parts Description
023-407-00	1	12 1/4" x 5" 15K Hydraulic RH
059-637-00	1	Instruction Sheet



## Brake Kit - LH

**K23-162-00**

Complete 12 1/4" x 5" hydraulic duo-servo forward self-adjust with park brake assembly (15K).

Dx Part No.	Quantity	Parts Description
023-162-00	1	12 1/4" x 5" 15K Hydraulic LH
059-637-00	1	Instruction Sheet



## Brake Kit - RH

**K23-163-00**

Complete 12 1/4" x 5" hydraulic duo-servo forward self-adjust with park brake assembly (15K).

Dx Part No.	Quantity	Parts Description
023-163-00	1	12 1/4" x 5" 15K Hydraulic RH
059-637-00	1	Instruction Sheet





## Electric Brake Controller

**058-008-00**

Inertia-activated electric brake controller. For use on single and tandem axle trailers.

Dx Part No.	Quantity	Parts Description
058-008-00	1	Predator DX2 Brake Controller



## Electric/Hydraulic Brake Actuator 1000 PSI

**K71-650-00**

Electric/hydraulic brake actuator for axles equipped with drum brakes.

Dx Part No.	Quantity	Parts Description
071-650-00	1	Electric/Hydraulic Brake Actuator - 1000
LIT-608-00	1	E/H Brake Actuator Service Manual



## Electric/Hydraulic Brake Actuator 1600 PSI

**K71-651-00**

Electric/hydraulic brake actuator for axles equipped with disc brakes.

Dx Part No.	Quantity	Parts Description
071-651-00	1	Electric/Hydraulic Actuator - 1600
LIT-608-00	1	E/H Brake Actuator Service Manual



## Electric/Hydraulic Brake Actuator Fill Cap & Gasket

**K71-685-00**

Fits Dexter 1000 & 1600 E/H brake actuator.

Dx Part No.	Quantity	Parts Description
097-011-01	1	Reservoir Cap Assembly, E/H Brake Actuator



## Electric/Hydraulic Brake Actuator Gasket

**K71-688-00**

Fits Dexter 1000 & 1600 E/H brake actuator.

Dx Part No.	Quantity	Parts Description
010-160-00	2	Gasket, E/H Brake Actuator



## 9 AMP Hour Breakaway Kit

**034-285-00**

Fits E/H brake actuator K71-650-00 and K71-651-00.

Dx Part No.	Quantity	Parts Description
034-285-00	1	Breakaway Battery, Charger and Switch



## Breakaway Switch Kit

**K71-691-00**

Replacement switch with breakaway pin and lanyard.

Dx Part No.	Quantity	Parts Description
065-005-00	1	Breakaway Switch

# Brake Components



## Brake Cylinder - LH

**K71-640-00**

Fits Dexter 7" x 1 $\frac{3}{4}$ " brakes, uni-servo, 1" diameter.

Dx Part No.	Quantity	Parts Description
054-080-03	1	Brake Cylinder Assembly, LH



## Brake Cylinder - RH

**K71-641-00**

Fits Dexter 7" x 1 $\frac{3}{4}$ " brakes, uni-servo, 1" diameter.

Dx Part No.	Quantity	Parts Description
054-080-04	1	Brake Cylinder Assembly, RH



## Brake Cylinder - LH

**K71-337-00**

Fits Dexter 10" x 2 $\frac{1}{4}$ " and 12" x 2" brakes, uni-servo, 1 $\frac{1}{8}$ " diameter.

Dx Part No.	Quantity	Parts Description
054-064-00	1	Brake Cylinder Assembly, LH



## Brake Cylinder - RH

**K71-338-00**

Fits Dexter 10" x 2 $\frac{1}{4}$ " and 12" x 2" brakes, uni-servo, 1 $\frac{1}{8}$ " diameter.

Dx Part No.	Quantity	Parts Description
054-065-00	1	Brake Cylinder Assembly, RH



### Brake Cylinder - LH

**K71-339-00**

Fits Dexter 10" x 2¼" and 12" x 2" brakes, duo-servo, 1⅛" diameter.

Dx Part No.	Quantity	Parts Description
054-062-00	1	Brake Cylinder Assembly, LH



### Brake Cylinder - RH

**K71-340-00**

Fits Dexter 10" x 2¼" and 12" x 2" brakes, duo-servo, 1⅛" diameter.

Dx Part No.	Quantity	Parts Description
054-063-00	1	Brake Cylinder Assembly, RH



### Brake Cylinder - LH

**K71-424-00**

Fits Dexter 10" x 2¼" and 12" x 2" free backing, corrosion resistant, hydraulic brakes, uni-servo, 1⅛" diameter.

Dx Part No.	Quantity	Parts Description
054-064-01	1	Brake Cylinder Assembly, LH



### Brake Cylinder - RH

**K71-425-00**

Fits Dexter 10" x 2¼" and 12" x 2" free backing, corrosion resistant, hydraulic brakes, uni-servo, 1⅛" diameter cylinder.

Dx Part No.	Quantity	Parts Description
054-065-01	1	Brake Cylinder Assembly, RH



## Brake Cylinder Rebuild Kit

**K71-080-00**

Fits Dexter 12¼" x 3⅜" with 1" diameter.

Dx Part No.	Quantity	Parts Description
046-130-00	1	Spring
054-032-00	2	Boot
054-035-00	1	Bleeder Screw
054-041-00	2	Piston
054-085-00	2	Cup



## Brake Cylinder Rebuild Kit

**K71-081-00**

Fits Dexter 12¼" x 3⅜", 12¼" x 4", 12¼" x 5" brakes; uni or duo-servo, 1¼" diameter.

Dx Part No.	Quantity	Parts Description
046-128-00	1	Spring
054-032-00	2	Boot
054-035-00	1	Bleeder Screw
054-038-00	2	Piston
054-086-00	2	Cup



## Brake Cylinder Rebuild Kit

**K71-082-00**

Fits Dexter 12¼" x 5" brakes; duo-servo, 1⅝" diameter (15K).

Dx Part No.	Quantity	Parts Description
046-129-00	1	Spring
054-030-00	2	Piston
054-032-00	2	Boot
054-035-00	1	Bleeder Screw
054-087-00	2	Cup





## Caliper Replacement Kit - LH or RH

**K71-624-00**

Fits Dexter 3.5K disc brakes.

Dx Part No.	Quantity	Parts Description
007-256-00	2	Screw, Cap
059-794-00	1	Instruction Sheet
089-004-02	1	Caliper Assembly, 3.5K



## Caliper Replacement Kit - LH or RH

**K71-636-00**

Fits Dexter 6K disc brakes.

Dx Part No.	Quantity	Parts Description
006-045-00	4	Nut, Hex Locking
006-289-00	1	Nut, Hex
007-254-00	4	Bolt, Hex
007-469-00	1	Screw, Hex
027-060-00	1	Clamp, Tube
046-145-00	1	Spring, Anti-Rattle
054-092-00	1	Bleeder Screw
054-094-00	1	Adapter Hydraulic $\frac{3}{16}$ Inverted
059-799-00	1	Instruction Sheet
071-513-00	1	Brake Line Assembly
071-517-00	1	Brake Line
087-002-00	1	Screw, Hex
089-005-06	2	Caliper Assembly



## Caliper Replacement Kit - LH or RH

**K71-693-00**

Fits Dexter 7K disc brakes.

Dx Part No.	Quantity	Parts Description
006-045-00	4	Nut, Hex Locking
006-289-00	1	Nut, Hex
007-254-00	4	Bolt, Hex
007-469-00	1	Screw, Hex
027-060-00	1	Clamp, Tube
046-145-00	1	Spring, Anti-Rattle
054-092-00	1	Bleeder Screw
054-094-00	1	Adapter Hydraulic $\frac{3}{16}$ Inverted
059-799-00	1	Instruction Sheet
071-517-00	1	Brake Line
087-002-00	1	Screw, Hex
089-005-06	2	Caliper Assembly



## Caliper Replacement Kit - LH or RH

**K71-630-00**

Fits Dexter 8K disc brakes.

Dx Part No.	Quantity	Parts Description
006-045-00	4	Nut, Hex Locking
006-289-00	1	Nut, Hex
007-254-00	4	Bolt, Hex
007-469-00	1	Screw, Hex
027-060-00	1	Clamp, Tube
046-145-00	1	Spring, Anti-Rattle
054-092-00	1	Bleeder Screw
054-094-00	1	Adapter Hydraulic $\frac{3}{16}$ Inverted
059-799-00	1	Instruction Sheet
071-513-00	1	Brake Line Assembly
071-518-00	1	Brake Line
087-002-00	1	Screw, Hex
089-003-02	2	Caliper Assembly, 8K



## Caliper Repair Kit

**K71-670-00**

Fits Dexter 6K, 7K and 8K disc brake axles.

Dx Part No.	Quantity	Parts Description
054-090-00	4	Seal, Piston
054-091-00	4	Boot
054-092-00	1	Bleeder Screw
054-094-00	1	Adapter Hydraulic $\frac{3}{16}$ Inverted



## Caliper Repair Kit

**K71-181-00**

Fits Dexter 10K and 12K disc brake axles (after 1/88).

Dx Part No.	Quantity	Parts Description
010-062-00	4	O-Ring
054-067-00	2	Seal for 2.50 Diameter Piston
054-068-00	2	Boot
054-069-00	1	Bleeder Screw



## Magnet Kit

**K71-057-00**

Fits Dexter 7" x 1¼" brake (after 4/1/90) and 10" x 1½" brakes (prior to 9/1/88).

Dx Part No.	Quantity	Parts Description
042-134-00	1	Magnet Assembly (white wire)
046-086-00	1	Spring, Magnet
046-121-00	1	Magnet Retainer Clip
059-511-00	1	Instruction Sheet

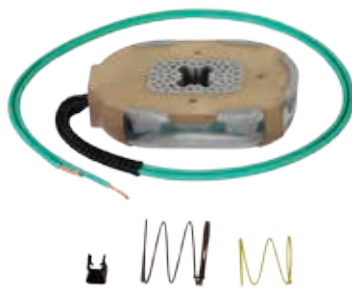

## Magnet Kit

**K71-104-00**

Fits Dexter 10" x 1½" and 10 x 2¼" brakes.

Dx Part No.	Quantity	Parts Description
027-009-00	1	Retaining Clip
042-140-00	1	Magnet Assembly (green wire)
046-080-00	1	Spring, Magnet (before 7/16)
046-175-00	1	Spring, Magnet (after 7/16)
059-511-00	1	Instruction Sheet

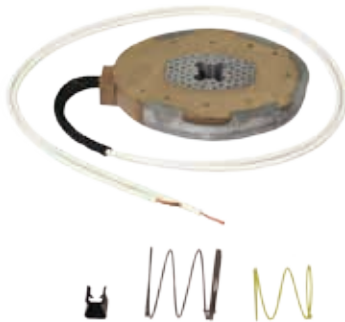

## Magnet Kit

**K71-105-00**

Fits Dexter 12" x 2" 5.2K and 6K brakes.

Dx Part No.	Quantity	Parts Description
027-009-00	1	Retaining Clip
042-144-00	1	Magnet Assembly (white wire)
046-080-00	1	Spring, Magnet (before 7/16)
046-175-00	1	Spring, Magnet (after 7/16)
059-511-00	1	Instruction Sheet

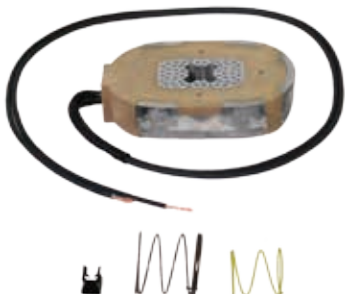

## Magnet Kit

**K71-125-00**

Fits Dexter 12" x 2" 7K and 10" x 2¼" 4.4K brakes.

Dx Part No.	Quantity	Parts Description
027-009-00	1	Retaining Clip
042-143-00	1	Magnet Assembly (black wire)
046-080-00	1	Spring, Magnet (before 7/16)
046-175-00	1	Spring, Magnet (after 7/16)
059-511-00	1	Instruction Sheet

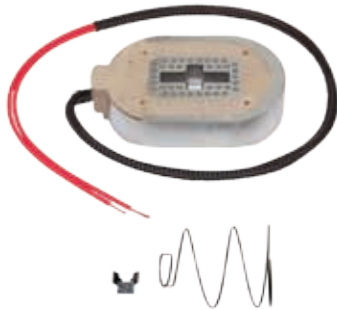

**Magnet Kit**

**K71-441-00**

Fits Dexter 12¼" x 2½" 7.2K electric brakes.

Dx Part No.	Quantity	Parts Description
027-050-00	1	Magnet Retainer
042-136-00	1	Magnet Assembly (red wire)
046-117-00	1	Spring, Magnet
059-511-00	1	Instruction Sheet



**Magnet Kit**

**K71-375-00**

Fits Dexter 12¼" x 3¾" 8K electric brakes (after 6/92).

Dx Part No.	Quantity	Parts Description
027-050-00	1	Magnet Retainer
042-127-00	1	Magnet Assembly (white wire)
046-117-00	1	Spring, Magnet
059-511-00	1	Instruction Sheet



**Magnet Kit**

**K71-376-00**

Fits Dexter 12¼" x 3¾" 9-10K or 12¼" x 4" 10K heavy duty electric brakes (after 6/92).

Dx Part No.	Quantity	Parts Description
027-050-00	1	Magnet Retainer
042-129-00	1	Magnet Assembly (yellow wire)
046-117-00	1	Spring, Magnet
059-511-00	1	Instruction Sheet



**Magnet Kit**

**K71-377-00**

Fits Dexter 12¼" x 5" 12K electric brakes (after 6/92).

Dx Part No.	Quantity	Parts Description
027-050-00	1	Magnet Retainer
042-130-00	1	Magnet Assembly (black wire)
046-117-00	1	Spring, Magnet
059-511-00	1	Instruction Sheet



## Magnet Kit

K71-378-00

Fits Dexter 12¼" x 5" 15K electric brakes (after 6/92).

Dx Part No.	Quantity	Parts Description
027-050-00	1	Magnet Retainer
042-131-00	1	Magnet Assembly (blue wire)
046-117-00	1	Spring, Magnet
059-511-00	1	Instruction Sheet





**Brake Shoe & Lining Kit**

**K71-045-00**

Fits Dexter 7" x 1 1/4" electric brake.

Dx Part No.	Quantity	Parts Description
040-049-00	1	Shoe & Lining, Secondary
040-125-00	1	Shoe & Lining, Primary
059-043-00	1	Instruction Sheet



**Brake Shoe & Lining Kit**

**K71-466-00**

Fits Dexter 7" x 1 3/4" hydraulic brake.

Dx Part No.	Quantity	Parts Description
035-001-00	4	Shoe Hold Down Spring, Cup
040-327-01	1	Shoe & Lining, Primary
040-328-01	1	Shoe & Lining, Secondary
046-006-00	2	Shoe Hold Down Spring, No Cup
049-014-00	2	Hold Down Pin
059-581-00	1	Instruction Sheet



**Brake Shoe & Lining Kit**

**K71-046-00**

Fits Dexter 10" x 1 1/2" electric brake.

Dx Part No.	Quantity	Parts Description
035-001-00	2	Shoe Hold Down Spring, Cup
040-129-00	1	Shoe & Lining, Primary
040-130-00	1	Shoe & Lining, Secondary
046-006-00	2	Shoe Hold Down Spring, No Cup
049-009-00	2	Hold Down Pin
059-044-00	1	Instruction Sheet



**Brake Shoe & Lining Kit - LH**

**K71-701-00**

Fits Dexter 10" x 1 1/2" electric brake, Nev-R-Adjust.

Dx Part No.	Quantity	Parts Description
035-001-00	2	Shoe Hold Down Spring, Cup
040-129-00	1	Shoe & Lining, Primary
040-375-00	1	Shoe & Lining, Secondary
046-006-00	2	Shoe Hold Down Spring, No Cup
049-009-00	2	Hold Down Pin
059-044-00	1	Instruction Sheet



## Brake Shoe & Lining Kit - RH

**K71-702-00**

Fits Dexter 10" x 1½" electric brake, Nev-R-Adjust.

Dx Part No.	Quantity	Parts Description
035-001-00	2	Shoe Hold Down Spring, Cup
040-129-00	1	Shoe & Lining, Primary
040-376-00	1	Shoe & Lining, Secondary
046-006-00	2	Shoe Hold Down Spring, No Cup
049-009-00	2	Hold Down Pin
059-044-00	1	Instruction Sheet



## Brake Shoe & Lining Kit

**K71-047-00**

Fits Dexter 10" x 2¼" electric brake (3.5K).

Dx Part No.	Quantity	Parts Description
040-017-00	1	Shoe & Lining, Primary
040-021-00	1	Shoe & Lining, Secondary
046-077-00	2	Shoe Hold Down Spring, Cup
049-002-00	2	Hold Down Pin
059-045-00	1	Instruction Sheet



## Brake Shoe & Lining Kit

**K71-672-00**

Fits Dexter 10" x 2¼" electric brake (4.4K).

Dx Part No.	Quantity	Parts Description
040-361-00	1	Shoe & Lining, Primary
040-362-00	1	Shoe & Lining, Secondary
046-077-00	2	Shoe Hold Down Spring, Cup
049-002-00	2	Hold Down Pin
059-045-00	1	Instruction Sheet



## Brake Shoe & Lining Kit - LH

**K71-681-00**

Fits Dexter 10" x 2¼" electric brake, Nev-R-Adjust (3.5K).

Dx Part No.	Quantity	Parts Description
040-367-00	1	Shoe & Lining, Primary
040-368-01	1	Shoe & Lining, Secondary
046-077-00	2	Shoe Hold Down Spring, Cup
049-002-00	2	Hold Down Pin
059-045-00	1	Instruction Sheet



## Brake Shoe & Lining Kit - RH

**K71-682-00**

Fits Dexter 10" x 2¼" electric brake, Nev-R-Adjust (3.5K).

Dx Part No.	Quantity	Parts Description
040-367-00	1	Shoe & Lining, Primary
040-368-02	1	Shoe & Lining, Secondary
046-077-00	2	Shoe Hold Down Spring, Cup
049-002-00	2	Hold Down Pin
059-045-00	1	Instruction Sheet



## Brake Shoe & Lining Kit - LH

**K71-698-00**

Fits Dexter 10" x 2¼" electric brake, Nev-R-Adjust (4.4K).

Dx Part No.	Quantity	Parts Description
040-379-00	1	Shoe & Lining, Primary
040-380-01	1	Shoe & Lining, Secondary
046-077-00	2	Shoe Hold Down Spring, Cup
049-002-00	2	Hold Down Pin
059-045-00	1	Instruction Sheet



## Brake Shoe & Lining Kit - RH

**K71-699-00**

Fits Dexter 10" x 2¼" electric brake, Nev-R-Adjust (4.4K).

Dx Part No.	Quantity	Parts Description
040-379-00	1	Shoe & Lining, Primary
040-380-02	1	Shoe & Lining, Secondary
046-077-00	2	Shoe Hold Down Spring, Cup
049-002-00	2	Hold Down Pin
059-045-00	1	Instruction Sheet



## Brake Shoe & Lining Kit

**K71-267-00**

Fits Dexter 10" x 2¼" hydraulic brake.

Dx Part No.	Quantity	Parts Description
040-210-00	1	Shoe & Lining, Primary
040-211-00	1	Shoe & Lining, Secondary
046-077-00	2	Shoe Hold Down Spring, Cup
049-002-00	2	Hold Down Pin
059-260-00	1	Instruction Sheet



## Brake Shoe & Lining Kit

**K71-393-00**

Fits Dexter 10" x 2¼" free backing hydraulic brake.

Dx Part No.	Quantity	Parts Description
040-211-00	1	Shoe & Lining, Secondary
040-291-00	1	Shoe & Lining, Primary
046-077-00	2	Shoe Hold Down Spring, Cup
049-002-00	2	Hold Down Pin
059-818-00	1	Instruction Sheet



## Brake Shoe & Lining Kit

**K71-423-00**

Fits Dexter 10" x 2¼" free backing, corrosion resistant, hydraulic brake.

Dx Part No.	Quantity	Parts Description
040-291-03	1	Shoe & Lining, Primary
040-292-03	1	Shoe & Lining, Secondary
046-077-01	2	Shoe Hold Down Spring, Cup
049-002-00	2	Hold Down Pin
059-818-00	1	Instruction Sheet



## Brake Shoe & Lining Kit

**K71-127-00**

Fits Dexter 12" x 2" electric brake (6K and 7K).

Dx Part No.	Quantity	Parts Description
040-215-00	1	Shoe & Lining, Primary
040-216-00	1	Shoe & Lining, Secondary
046-077-00	2	Shoe Hold Down Spring, Cup
049-011-00	2	Hold Down Pin
059-045-00	1	Instruction Sheet



## Brake Shoe & Lining Kit - LH

**K71-675-00**

Fits Dexter 12" x 2" electric brake, Nev-R-Adjust (7K).

Dx Part No.	Quantity	Parts Description
040-215-00	1	Shoe & Lining, Primary
040-216-01	1	Shoe & Lining, Secondary
046-077-00	2	Shoe Hold Down Spring, Cup
049-011-00	2	Hold Down Pin
059-045-00	1	Instruction Sheet



## Brake Shoe & Lining Kit - RH

**K71-676-00**

Fits Dexter 12" x 2" electric brake, Nev-R-Adjust (7K).

Dx Part No.	Quantity	Parts Description
040-215-00	1	Shoe & Lining, Primary
040-216-02	1	Shoe & Lining, Secondary
046-077-00	2	Shoe Hold Down Spring, Cup
049-011-00	2	Hold Down Pin
059-045-00	1	Instruction Sheet



## Brake Shoe & Lining Kit

**K71-268-00**

Fits Dexter 12" x 2" hydraulic brake (5.2K).

Dx Part No.	Quantity	Parts Description
040-204-00	1	Shoe & Lining, Primary
040-206-00	1	Shoe & Lining, Secondary
046-077-00	2	Shoe Hold Down Spring, Cup
049-012-00	2	Hold Down Pin
059-260-00	1	Instruction Sheet



## Brake Shoe & Lining Kit - LH

**K71-269-00**

Fits Dexter 12" x 2" hydraulic brake (7K).

Dx Part No.	Quantity	Parts Description
040-218-02	1	Shoe & Lining, Secondary
040-219-00	1	Shoe & Lining, Primary
046-077-00	2	Shoe Hold Down Spring, Cup
049-012-00	2	Hold Down Pin
059-260-00	1	Instruction Sheet



## Brake Shoe & Lining Kit - RH

**K71-270-00**

Fits Dexter 12" x 2" hydraulic brake (7K).

Dx Part No.	Quantity	Parts Description
040-218-01	1	Shoe & Lining, Secondary
040-219-00	1	Shoe & Lining, Primary
046-077-00	2	Shoe Hold Down Spring, Cup
049-012-00	2	Hold Down Pin
059-260-00	1	Instruction Sheet





## Brake Shoe & Lining Kit - LH

**K71-394-00**

Fits Dexter 12" x 2" free backing hydraulic brake.

Dx Part No.	Quantity	Parts Description
035-001-00	2	Shoe Hold Down Spring, Cup
040-243-08	1	Shoe & Lining, Primary
040-315-02	1	Shoe & Lining, Secondary
046-006-00	1	Shoe Hold Down Spring, No Cup
046-077-00	1	Shoe Hold Down Spring, Cup
049-002-00	1	Hold Down Pin
049-013-00	1	Hold Down Pin
059-818-00	1	Instruction Sheet



## Brake Shoe & Lining Kit - RH

**K71-395-00**

Fits Dexter 12" x 2" free backing hydraulic brake.

Dx Part No.	Quantity	Parts Description
035-001-00	2	Shoe Hold Down Spring, Cup
040-243-09	1	Shoe & Lining, Primary
040-315-01	1	Shoe & Lining, Secondary
046-006-00	1	Shoe Hold Down Spring, No Cup
046-077-00	1	Shoe Hold Down Spring, Cup
049-002-00	1	Hold Down Pin
049-013-00	1	Hold Down Pin
059-818-00	1	Instruction Sheet



## Brake Shoe & Lining Kit - LH

**K71-427-00**

Fits Dexter 12" x 2" free backing, corrosion resistant hydraulic brake.

Dx Part No.	Quantity	Parts Description
035-001-00	2	Shoe Hold Down Spring, Cup
040-243-06	1	Shoe & Lining, Primary
040-315-06	1	Shoe & Lining, Secondary
046-006-01	1	Shoe Hold Down Spring, No Cup
046-077-01	1	Shoe Hold Down Spring, Cup
049-002-00	1	Hold Down Pin
049-013-00	1	Hold Down Pin
059-818-00	1	Instruction Sheet



## Brake Shoe & Lining Kit - RH

**K71-428-00**

Fits Dexter 12" x 2" free backing, corrosion resistant hydraulic brake.

Dx Part No.	Quantity	Parts Description
035-001-00	2	Shoe Hold Down Spring, Cup
040-243-07	1	Shoe & Lining, Primary
040-315-05	1	Shoe & Lining, Secondary
046-006-01	1	Shoe Hold Down Spring, No Cup
046-077-01	1	Shoe Hold Down Spring, Cup
049-002-00	1	Hold Down Pin
049-013-00	1	Hold Down Pin
059-818-00	1	Instruction Sheet

# Brake Components



## 12¼" Electric Brakes

Please note that there are two styles of brakes with different shoe and lining kits. In April 2000, Dexter began manufacturing brakes with **Cast Backing Plates** rather than the old style **Stamped Backing Plates**.

Please verify which style of brake you have to ensure proper shoe and lining kit.

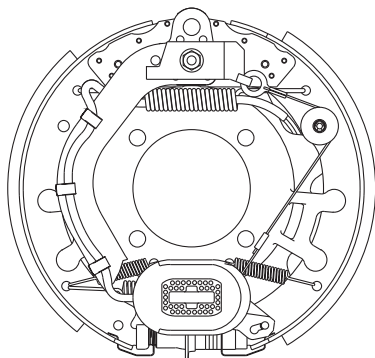

**New Style Brake**  
**Cast Backing Plate**

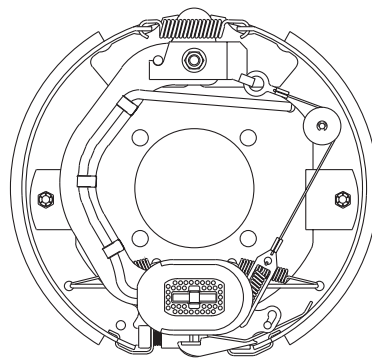

**Old Style Brake**  
**Stamped Backing Plate**



### Brake Shoe & Lining Kit - LH or RH

**K71-410-00**

**Stamped Backing Plate Prior to 4/00.**

Fits Dexter 12¼" x 2½" electric brake (7.2K), stamped backing plate.

Dx Part No.	Quantity	Parts Description
005-107-00	2	Washer, Shoe Hold Down
006-127-00	2	Nut, Hex Locking
040-309-01	1	Shoe & Lining
040-310-01	1	Shoe & Lining



### Brake Shoe & Lining Kit- LH

**K71-497-00**

**Cast Backing Plate as of 4/00.**

Fits Dexter 12¼" x 2½" electric brake (7.2K), cast backing plate.

Dx Part No.	Quantity	Parts Description
040-348-01	1	Shoe & Lining, Primary
040-349-02	1	Shoe & Lining, Secondary
059-653-00	1	Instruction Sheet



## Brake Shoe & Lining Kit- RH

**K71-496-00**

**Cast Backing Plate as of 4/00.**

Fits Dexter 12¼" x 2½" electric brake (7.2K), cast backing plate.

Dx Part No.	Quantity	Parts Description
040-348-02	1	Shoe & Lining, Secondary
040-349-01	1	Shoe & Lining, Primary
059-653-00	1	Instruction Sheet



## Brake Shoe & Lining Kit - LH

**K71-049-00**

**Stamped Backing Plate Prior to 4/00.**

Fits Dexter 12¼" x 3⅜" electric brake (8K, 9K, 10K GD), stamped backing plate.

Dx Part No.	Quantity	Parts Description
005-107-00	2	Washer, Shoe Hold Down
006-127-00	2	Nut, Hex Locking
040-110-01	1	Shoe & Lining, Primary
040-111-02	1	Shoe & Lining, Secondary
059-046-00	1	Instruction Sheet



## Brake Shoe & Lining Kit - RH

**K71-050-00**

**Stamped Backing Plate Prior to 4/00.**

Fits Dexter 12¼" x 3⅜" electric brake (8K, 9K, 10K GD), stamped backing plate.

Dx Part No.	Quantity	Parts Description
005-107-00	2	Washer, Shoe Hold Down
006-127-00	2	Nut, Hex Locking
040-110-02	1	Shoe & Lining, Secondary
040-111-01	1	Shoe & Lining, Primary
059-046-00	1	Instruction Sheet



## Brake Shoe & Lining Kit - LH

**K71-499-00**

**Cast Backing Plate as of 4/00.**

Fits Dexter 12¼" x 3⅜" electric brake (8K, 9K, 10K GD), cast backing plate.

Dx Part No.	Quantity	Parts Description
040-350-01	1	Shoe & Lining, Primary
040-351-02	1	Shoe & Lining, Secondary
059-653-00	1	Instruction Sheet



## Brake Shoe & Lining Kit - RH

**K71-498-00**

### Cast Backing Plate as of 4/00.

Fits Dexter 12¼" x 3⅜" electric brake (8K, 9K, 10K GD), cast backing plate.

Dx Part No.	Quantity	Parts Description
040-350-02	1	Shoe & Lining, Secondary
040-351-01	1	Shoe & Lining, Primary
059-653-00	1	Instruction Sheet



## Brake Shoe & Lining Kit - LH

**K71-165-00**

Fits Dexter 12¼" x 3⅜" hydraulic brake (8K, 9K, 10K GD).

Dx Part No.	Quantity	Parts Description
005-107-00	2	Washer, Shoe Hold Down
006-086-00	2	Nut, Hex Locking
040-199-01	1	Shoe & Lining, Primary
040-199-02	1	Shoe & Lining, Secondary
059-101-00	1	Instruction Sheet



## Brake Shoe & Lining Kit - RH

**K71-166-00**

Fits Dexter 12¼" x 3⅜" hydraulic brake (8K, 9K, 10K GD)

Dx Part No.	Quantity	Parts Description
005-107-00	2	Washer, Shoe Hold Down
006-086-00	2	Nut, Hex Locking
040-200-01	1	Shoe & Lining, Primary
040-200-02	1	Shoe & Lining, Secondary
059-101-00	1	Instruction Sheet



## Brake Shoe & Lining Kit - LH

**K71-437-00**

Fits Dexter 12¼" x 3⅜" corrosion resistant, hydraulic brake (8K, 9K, 10K GD).

Dx Part No.	Quantity	Parts Description
005-107-02	2	Washer, Shoe Hold Down
006-086-00	2	Nut, Hex Locking
040-199-05	1	Shoe & Lining, Primary
040-199-06	1	Shoe & Lining, Secondary
059-101-00	1	Instruction Sheet



## Brake Shoe & Lining Kit - RH

**K71-438-00**

Fits Dexter 12¼" x 3⅜" corrosion resistant, hydraulic brake (8K, 9K, 10K GD).

Dx Part No.	Quantity	Parts Description
005-107-02	2	Washer, Shoe Hold Down
006-086-00	2	Nut, Hex Locking
040-200-05	1	Shoe & Lining, Primary
040-200-06	1	Shoe & Lining, Secondary
059-101-00	1	Instruction Sheet



## Brake Shoe & Lining Kit - LH

**K71-444-00**

Fits Dexter 12¼" x 3⅜" hydraulic brake - for TAG axle.

Dx Part No.	Quantity	Parts Description
005-107-00	2	Washer, Shoe Hold Down
006-086-00	2	Nut, Hex Locking
040-317-01	1	Shoe & Lining, Primary
040-317-02	1	Shoe & Lining, Secondary
059-101-00	1	Instruction Sheet



## Tag Brake Shoe & Lining Kit - RH

**K71-445-00**

Fits Dexter 12¼" x 3⅜" hydraulic brake - for TAG axle.

Dx Part No.	Quantity	Parts Description
005-107-00	2	Washer, Shoe Hold Down
006-086-00	2	Nut, Hex Locking
040-316-01	1	Shoe & Lining, Primary
040-316-02	1	Shoe & Lining, Secondary
059-101-00	1	Instruction Sheet



## Brake Shoe & Lining Kit - LH

**K71-051-00**

**Stamped Backing Plate Prior to 4/00.**

Fits Dexter 12¼" x 4" electric brake (10K HD), stamped backing plate.

Dx Part No.	Quantity	Parts Description
005-107-00	2	Washer, Shoe Hold Down
006-127-00	2	Nut, Hex Locking
040-108-01	1	Shoe & Lining, Primary
040-109-02	1	Shoe & Lining, Secondary
059-046-00	1	Instruction Sheet





## Brake Shoe & Lining Kit - RH

**K71-052-00**

**Stamped Backing Plate Prior to 4/00.**

Fits Dexter 12¼" x 4" electric brake (10K HD), stamped backing plate.

Dx Part No.	Quantity	Parts Description
005-107-00	2	Washer, Shoe Hold Down
006-127-00	2	Nut, Hex Locking
040-109-01	1	Shoe & Lining, Primary
040-108-02	1	Shoe & Lining, Secondary
059-046-00	1	Instruction Sheet



## Brake Shoe & Lining Kit - LH

**K71-501-00**

**Cast Backing Plate as of 4/00.**

Fits Dexter 12¼" x 4" electric brake (10K HD), cast backing plate.

Dx Part No.	Quantity	Parts Description
040-352-01	1	Shoe & Lining, Primary
040-353-02	1	Shoe & Lining, Secondary
059-653-00	1	Instruction Sheet



## Brake Shoe & Lining Kit - RH

**K71-500-00**

**Cast Backing Plate as of 4/00.**

Fits Dexter 12¼" x 4" electric brake (10K HD), cast backing plate.

Dx Part No.	Quantity	Parts Description
040-352-02	1	Shoe & Lining, Secondary
040-353-01	1	Shoe & Lining, Primary
059-653-00	1	Instruction Sheet



## Brake Shoe & Lining Kit - LH

**K71-167-00**

Fits Dexter 12¼" x 4" hydraulic brake (10K HD).

Dx Part No.	Quantity	Parts Description
005-107-00	2	Washer, Shoe Hold Down
006-086-00	2	Nut, Hex Locking
040-197-01	1	Shoe & Lining, Primary
040-197-02	1	Shoe & Lining, Secondary
059-101-00	1	Instruction Sheet



## Brake Shoe & Lining Kit - RH

**K71-168-00**

Fits Dexter 12¼" x 4" hydraulic brake (10K HD).

Dx Part No.	Quantity	Parts Description
005-107-00	2	Washer, Shoe Hold Down
006-086-00	2	Nut, Hex Locking
040-198-01	1	Shoe & Lining, Primary
040-198-02	1	Shoe & Lining, Secondary
059-101-00	1	Instruction Sheet



## Brake Shoe & Lining Kit - LH

**K71-053-00**

**Stamped Backing Plate Prior to 4/00.**

Fits Dexter 12¼" x 5" electric brake (12K-15K), stamped backing plate.

Dx Part No.	Quantity	Parts Description
005-107-00	2	Washer, Shoe Hold Down
006-127-00	2	Nut, Hex Locking
040-102-01	1	Shoe & Lining, Primary
040-103-02	1	Shoe & Lining, Secondary
059-046-00	1	Instruction Sheet



## Brake Shoe & Lining Kit - RH

**K71-054-00**

**Stamped Backing Plate Prior to 4/00.**

Fits Dexter 12¼" x 5" electric brake (12K-15K), stamped backing plate.

Dx Part No.	Quantity	Parts Description
005-107-00	2	Washer, Shoe Hold Down
006-127-00	2	Nut, Hex Locking
040-102-02	1	Shoe & Lining, Secondary
040-103-01	1	Shoe & Lining, Primary
059-046-00	1	Instruction Sheet



## Brake Shoe & Lining Kit - LH

**K71-503-00**

**Cast Backing Plate as of 4/00.**

Fits Dexter 12¼" x 5" electric brake (12K-15K), cast backing plate.

Dx Part No.	Quantity	Parts Description
040-354-01	1	Shoe & Lining, Primary
040-355-02	1	Shoe & Lining, Secondary
059-653-00	1	Instruction Sheet



## Brake Shoe & Lining Kit - RH

**K71-502-00**

### Cast Backing Plate as of 4/00.

Fits Dexter 12¼" x 5" electric brake (12K-15K), cast backing plate.

Dx Part No.	Quantity	Parts Description
040-354-02	1	Shoe & Lining, Secondary
040-355-01	1	Shoe & Lining, Primary
059-653-00	1	Instruction Sheet



## Brake Shoe & Lining Kit - LH

**K71-169-00**

Fits Dexter 12¼" x 5" hydraulic brake (12K-15K).

Dx Part No.	Quantity	Parts Description
005-107-00	2	Washer, Shoe Hold Down
006-086-00	2	Nut, Hex Locking
040-195-01	1	Shoe & Lining, Primary
040-195-02	1	Shoe & Lining, Secondary
059-101-00	1	Instruction Sheet



## Brake Shoe & Lining Kit - RH

**K71-170-00**

Fits Dexter 12¼" x 5" hydraulic brake (12K-15K).

Dx Part No.	Quantity	Parts Description
005-107-00	2	Washer, Shoe Hold Down
006-086-00	2	Nut, Hex Locking
040-196-01	1	Shoe & Lining, Primary
040-196-02	1	Shoe & Lining, Secondary
059-101-00	1	Instruction Sheet

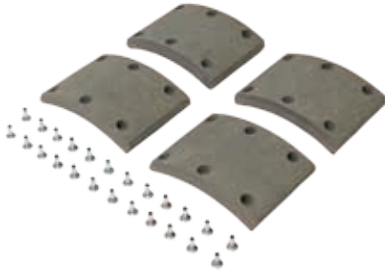

## Brake Block Kit

**K71-102-00**

Fits Dexter 12¼" x 4" air brake.

Dx Part No.	Quantity	Parts Description
022-018-00	24	Rivet, Semi-Tubular
041-052-01	2	Brake Block, Anchor
041-052-02	2	Brake Block, Cam
059-191-00	1	Instruction Sheet

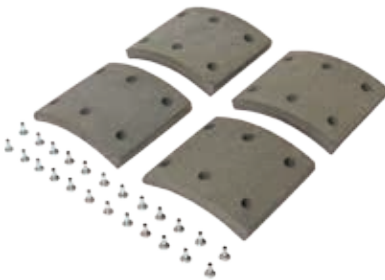

## Brake Block Kit

**K71-152-00**

Fits Dexter 12¼" x 5" air brake.

Dx Part No.	Quantity	Parts Description
022-018-00	24	Rivet, Semi-Tubular
041-053-01	2	Brake Block, Anchor
041-053-02	2	Brake Block, Cam
059-191-00	1	Instruction Sheet



## Brake Block Kit

**K71-133-00**

Fits Dexter 12¼" x 7½" air brake.

Dx Part No.	Quantity	Parts Description
022-018-00	48	Rivet, Semi-Tubular
041-057-01	2	Brake Block, Anchor
041-060-01	2	Brake Block, Cam
059-191-00	1	Instruction Sheet



## Brake Block Kit

**K71-138-00**

Fits Dexter 16½" x 7" air brake.

Dx Part No.	Quantity	Parts Description
022-018-00	48	Rivet, Semi-Tubular
041-058-01	2	Brake Block, Cam
041-059-01	2	Brake Block, Anchor
059-191-00	1	Instruction Sheet



## Disc Brake Pad Kit

**K71-180-00**

Fits Dexter 10K or 12K axle.

Dx Part No.	Quantity	Parts Description
006-228-00	4	Nut, Hex Locking
010-062-00	20	O-Ring
046-105-00	4	Spring, Anti-Rattle
059-214-00	1	Instruction Sheet
071-182-00	1	Installation Tool
088-008-00	1	Grease Packet
091-003-00	4	Brake Pad Assembly



## Brake Pad Replacement Kit

**K71-623-00**

Fits Dexter 3.5K disc brakes; services two brakes.

Dx Part No.	Quantity	Parts Description
059-793-00	1	Instruction Sheet
091-006-00	1	Brake Pad Set



## Brake Pad Replacement Kit

**K71-629-00**

Fits Dexter 6K, 7K and 8K disc brakes; services two brakes.

Dx Part No.	Quantity	Parts Description
006-289-00	2	Nut, Hex
007-469-00	2	Screw, Hex
046-145-00	2	Spring, Anti-Rattle
059-798-00	1	Instruction Sheet
091-004-00	4	Brake Pad Assembly





## Brake Shoe Hardware Kit

**K71-098-00**

Fits "P" style Dexter 10K-27K 12¼" air brake axles; for one brake.

Dx Part No.	Quantity	Parts Description
005-072-00	4	Washer, Plain
005-073-00	4	Washer, Plain
005-076-00	2	Washer, Plain
007-137-00	1	Screw, Hex
014-057-00	2	Roller
014-104-00	2	Bushing
046-092-00	1	Spring, Retractor
056-010-00	2	Roller Pin
056-011-00	2	Anchor Pin
056-012-00	2	Retainer Pin, Retractor Spring
059-552-00	1	Instruction Sheet
069-018-00	2	Snap Ring
069-019-00	4	Snap Ring



## Brake Shoe Hardware Kit

**K71-460-00**

Fits "PQ" style Dexter 10K-27K 12¼" air brake axles; for one brake.

Dx Part No.	Quantity	Parts Description
005-076-00	2	Washer, Plain
014-057-00	2	Roller
014-068-00	2	Bushing
046-092-00	1	Spring, Retractor
046-097-00	2	Spring, Shoe Keeper
056-010-00	2	Roller Pin
056-017-00	2	Anchor Pin
056-018-00	2	Retainer Pin
059-553-00	1	Instruction Sheet
069-018-00	2	Snap Ring



## Brake Shoe Hardware Kit

**K71-136-00**

Fits "Q" quick change Dexter 16½" x 7" air brake axles; for one brake.

Dx Part No.	Quantity	Parts Description
014-065-00	2	Roller
014-068-00	2	Bushing
046-096-00	1	Spring, Retractor
046-097-00	2	Spring, Shoe Keeper
056-017-00	2	Anchor Pin
056-018-00	2	Retainer Pin
059-554-00	1	Instruction Sheet
071-122-00	2	Roller Retainer



## Torflex 90° Hose Kit

**K71-461-00**

Designed for tight clearance applications. Fits all Torflex axles; for one axle.

Dx Part No.	Quantity	Parts Description
007-222-00	2	Screw, Thread Forming
027-051-00	2	Clamp
034-257-00	2	Brake Hose Assembly
034-258-00	2	Bracket, Frame/Hose
034-259-00	2	Hose Clip
059-575-00	1	Instruction Sheet

# Brake Components



## Electric Brake Parts Kit

**K71-399-00**

Fits Dexter electric brakes; contains wire connection and retention parts.

Dx Part No.	Quantity	Parts Description
027-005-00	6	Wire Clip
027-009-00	2	Retaining Clip
027-027-00	4	Wire Cap, Heat Shrink
027-039-00	6	Wire Clip
027-050-00	2	Magnet Retainer
046-007-00	2	Plug
046-016-00	2	Brake Wire Grommet
046-121-00	2	Magnet Retainer Clip
067-006-00	4	Wire Connector



## Conduit Connector Kit

**K71-278-00**

Fits 10" x 2¼" and 12" x 2" electric brakes.

Dx Part No.	Quantity	Parts Description
005-138-00	1	Washer, Plain
006-099-00	1	Nut, Hex
007-120-00	2	Screw, Thread Forming
007-220-00	1	Screw, Hex
022-026-00	2	Rivet
027-036-00	2	Conduit Connector
027-037-00	2	Retainer
059-577-00	1	Instruction Sheet



## Camshaft Repair Kit

**K71-101-00**

Fits "P" and "PQ" style Dexter 10K, 12K, 15K, and 12¼" x 7½" air brake axles; for one brake.

Dx Part No.	Quantity	Parts Description
005-074-00	1	Washer, "D"
005-075-00	2	Washer, Plain
005-134-00	1	Washer, Plain
010-052-00	2	Seal, Grease 1.5
014-056-00	1	Bushing
014-058-00	1	Bushing
059-663-00	1	Instruction Sheet
061-006-00	1	Grease Fitting
069-020-00	2	Snap Ring
069-078-00	1	Snap Ring



## Camshaft Repair Kit

**K71-135-00**

Fits "Q" quick change Dexter 16½" x 7" air brake axles; for one brake.

Dx Part No.	Quantity	Parts Description
005-096-00	1	Washer, Plain
005-097-00	2	Washer, Plain
005-134-00	1	Washer, Plain
010-052-00	2	Seal, Grease 1.5
014-056-00	1	Bushing
014-058-00	1	Bushing
059-554-00	1	Instruction Sheet
061-006-00	1	Grease Fitting
069-020-00	2	Snap Ring
069-078-00	1	Snap Ring



## Brake Spring Kit

**K71-361-00**

Fits Dexter 7" x 1½" electric brake.

Dx Part No.	Quantity	Parts Description
046-022-00	1	Spring, Adjusting Screw
046-023-00	2	Spring, Shoe Hold Down
046-024-00	1	Spring, Retractor
046-086-00	1	Spring, Magnet
046-114-00	2	Spring, Shoe Centering



## Brake Spring Kit

**K71-362-00**

Fits Dexter 10" x 1½" electric brake.

Dx Part No.	Quantity	Parts Description
046-018-00	1	Spring, Adjuster
046-077-00	2	Shoe Hold Down Spring, Cup
046-084-00	1	Spring, Retractor
046-175-00	1	Spring, Magnet



## Brake Spring Kit

Fits Dexter 10" x 2¼" and 12" x 2" electric brakes without parking feature.

Dx Part No.	Quantity	Parts Description
046-009-00	2	Spring, Retractor
046-018-00	1	Spring, Adjuster
046-077-00	2	Shoe Hold Down Spring, Cup
046-175-00	1	Spring, Magnet



## Brake Spring Kit

**K71-426-00**

Fits Dexter 10" x 2¼" free backing, corrosion resistant hydraulic brake.

Dx Part No.	Quantity	Parts Description
046-009-01	1	Retractor Spring
046-077-01	2	Shoe Hold Down Spring, Cup
046-083-01	1	Adjuster Spring
046-107-03	1	Spring, Shoe Lever Return
046-108-03	1	Spring, Primary Shoe Return

# Brake Components



## Brake Spring Kit

**K71-434-00**

Fits Dexter 12" x 2" free backing, corrosion resistant hydraulic brake.

Dx Part No.	Quantity	Parts Description
035-001-00	2	Shoe Hold Down Spring, Cup
046-006-01	1	Shoe Hold Down Spring, No Cup
046-077-01	1	Shoe Hold Down Spring, Cup
046-101-01	1	Retractor Spring
046-107-03	1	Spring, Shoe Lever Return
046-108-03	1	Spring, Primary Shoe Return
046-123-01	1	Spring, Adjuster



## Brake Spring Kit

**K71-412-00**

Fits Dexter 12¼" x 2½" electric brake.

Dx Part No.	Quantity	Parts Description
046-018-00	1	Spring, Adjuster
046-117-00	1	Spring, Magnet
046-119-00	1	Retractor Spring
046-120-00	2	Spring, Shoe Centering
046-136-00	2	Spring, Shoe Centering



## Brake Spring Kit

**K71-421-00**

Fits Dexter 12¼" x 3¾", 12¼" x 4" and 12¼" x 5" electric brake with stamped backing plate.

Dx Part No.	Quantity	Parts Description
046-071-00	1	Spring, Shoe Return
046-072-00	1	Spring, Adjuster
046-083-00	1	Spring, Shoe Return
046-136-00	2	Spring, Shoe Centering
059-659-00	1	Instruction Sheet



## Brake Spring Kit

**K71-506-00**

Fits Dexter 12¼" x 3¾", 12¼" x 4" and 12¼" x 5" electric brake with cast backing plate.

Dx Part No.	Quantity	Parts Description
046-119-00	1	Retractor Spring
046-136-00	2	Spring, Shoe Centering
046-137-00	1	Adjuster Spring, FSA



## Brake Spring Kit

**K71-422-00**

Fits Dexter 12¼" x 3¾", 12¼" x 4" and 12¼" x 5" hydraulic brake.

Dx Part No.	Quantity	Parts Description
046-072-00	1	Spring, Adjuster
046-087-00	1	Spring, Retractor



## Brake Spring Kit

**K71-440-00**

Fits Dexter 12¼" x 3¾", 12¼" x 4" and 12¼" x 5" corrosion resistant hydraulic brake.

Dx Part No.	Quantity	Parts Description
046-072-01	1	Spring, Adjuster
046-087-01	1	Spring, Retractor



## Adjusting Screw & Spring Kit

**K71-323-00**

Fits Dexter 7" x 1¼" electric brake.

Dx Part No.	Quantity	Parts Description
043-021-00	1	Adjuster Screw Assembly
046-022-00	1	Spring, Adjusting Screw



## Adjusting Screw & Spring Kit

**K71-411-00**

Fits Dexter 12¼" x 2½" electric brake (7.2K) and all 12¼" manual adjust.

Dx Part No.	Quantity	Parts Description
046-018-00	1	Spring, Adjuster
048-017-00	1	Adjuster Assembly





**Adjusting Screw & Spring Kit**

**K71-703-00**

Fits Dexter 10" electric Nev-R-Adjust brakes, LH and RH.

Dx Part No.	Quantity	Parts Description
046-139-00	2	Spring, Adjuster
046-140-00	1	Spring, Adjuster Lever Torsion
046-141-00	1	Spring, Adjuster Lever Torsion
048-022-00	1	Adjuster Screw Assembly, LH
048-023-00	1	Adjuster Screw Assembly, RH
071-529-00	2	Cable Anchor Hook
071-532-01	1	Adjusting Lever, 10 " Electric LH
071-532-02	1	Adjusting Lever, 10" Electric RH
071-533-00	2	Adjuster Cable
071-655-01	1	Adjuster Cable, LH
071-655-02	1	Adjuster Cable, RH
071-656-00	2	Adjuster Cable



**Adjusting Screw & Spring Kit**

**K71-324-00**

Fits Dexter 10" x 1½", 10" x 2¼" hydraulic and electric, and 12" x 2" electric brakes.

Dx Part No.	Quantity	Parts Description
043-004-02	1	Adjuster Screw Assembly
046-018-00	1	Spring, Adjuster



**Adjusting Screw & Spring Kit**

**K71-679-00**

Fits Dexter 12" x 2" electric Nev-R-Adjust brakes, LH and RH.

Dx Part No.	Quantity	Parts Description
046-139-00	2	Spring, Adjuster
046-140-00	1	Spring, Adjuster Lever Torsion
046-141-00	1	Spring, Adjuster Lever Torsion
048-022-00	1	Adjuster Screw Assembly, LH
048-023-00	1	Adjuster Screw Assembly, RH
071-528-00	2	Adjuster Cable
071-529-00	2	Cable Anchor Hook
071-530-01	1	Self Adjusting Lever, LH
071-530-02	1	Self Adjusting Lever, RH



**Adjusting Screw & Spring Kit**

**K71-397-00**

Fits Dexter 10" x 2¼" free backing hydraulic brakes.

Dx Part No.	Quantity	Parts Description
043-004-02	1	Adjuster Screw Assembly
046-083-01	1	Adjuster Spring



## Adjusting Screw & Spring Kit

**K71-396-00**

Fits Dexter 12" x 2" hydraulic brakes.

Dx Part No.	Quantity	Parts Description
043-029-01	1	Adjuster Screw Assembly
046-102-00	1	Spring, Adjuster



## Adjusting Screw & Spring Kit

**K71-398-00**

Fits Dexter 12" x 2" free backing hydraulic brakes.

Dx Part No.	Quantity	Parts Description
043-028-00	1	Adjuster Screw Assembly
046-123-01	1	Spring, Adjuster



## Brake Adjuster Kit

**K71-418-00**

Fits Dexter 12 $\frac{1}{4}$ " x 3 $\frac{3}{8}$ ", 12 $\frac{1}{4}$ " x 4" and 12 $\frac{1}{4}$ " x 5" electric brakes with stamped backing plate; for one axle.

Dx Part No.	Quantity	Parts Description
046-073-00	1	Spring, Adjuster Level, LH
046-074-00	1	Spring, Adjuster Level, RH
048-009-00	1	Adjuster Screw Assembly, LH
048-010-00	1	Adjuster Screw Assembly, RH
071-019-01	1	Adjusting Lever - LH
071-019-02	1	Adjusting Lever - RH
071-020-00	2	Adjuster Cable



## Brake Adjuster Kit - LH

**K71-504-00**

Fits Dexter 12 $\frac{1}{4}$ " x 3 $\frac{3}{8}$ ", 12 $\frac{1}{4}$ " x 4" and 12 $\frac{1}{4}$ " x 5" electric brakes with cast backing plate.

Dx Part No.	Quantity	Parts Description
048-019-00	1	Adjuster Screw Assembly, LH
071-462-00	1	Adjuster Cable
071-464-00	1	Self Adjusting Lever, LH

# Brake Components



## Brake Adjuster Kit - RH

**K71-505-00**

Fits Dexter 12¼" x 3¾", 12¼" x 4" and 12¼" x 5" electric brake with cast backing plate.

Dx Part No.	Quantity	Parts Description
048-020-00	1	Adjuster Screw Assembly, RH
071-462-00	1	Adjuster Cable
071-463-00	1	Self Adjusting Lever, RH



## Brake Adjuster Kit

**K71-417-00**

Fits Dexter 12¼" x 3¾", 12¼" x 4" and 12¼" x 5" hydraulic brakes (prior to 2/97); for one axle.

Dx Part No.	Quantity	Parts Description
046-073-00	1	Spring, Adjuster Level, LH
046-074-00	1	Spring, Adjuster Level, RH
048-009-00	1	Adjuster Screw Assembly, LH
048-010-00	1	Adjuster Screw Assembly, RH
071-019-01	1	Adjusting Lever - LH
071-019-02	1	Adjusting Lever - RH
071-443-00	2	Adjuster Cable



## Brake Adjuster Kit

**K71-439-00**

Fits Dexter 12¼" x 3¾" corrosion resistant self-adjusting hydraulic brakes, 8K only (prior to 2/97).

Dx Part No.	Quantity	Parts Description
046-073-01	1	Spring, Adjuster Level, LH
046-074-01	1	Spring, Adjuster Level, RH
048-009-00	1	Adjuster Screw Assembly, LH
048-010-00	1	Adjuster Screw Assembly, RH
071-019-03	1	Adjusting Lever - LH
071-019-04	1	Adjusting Lever - RH
071-443-00	2	Adjuster Cable



## Brake Adjuster Kit

**K71-472-00**

Fits Dexter 12¼" forward self-adjusting hydraulic brakes (after 2/97).

Dx Part No.	Quantity	Parts Description
046-132-00	2	Clip, Adjuster
046-133-00	2	Clip, Adjuster
046-134-00	1	Adjuster Spring, RH
046-135-00	1	Adjuster Spring, LH
048-019-00	1	Adjuster Screw Assembly, LH
048-020-00	1	Adjuster Screw Assembly, RH
071-462-00	2	Adjuster Cable
071-463-00	1	Self Adjusting Lever, RH
071-464-00	1	Self Adjusting Lever, LH



## Brake Retrofit Kit

**K71-458-00**

Fits Dexter 12¼" x 3¾" and 12¼" x 4" electric brakes, forward self-adjust; services two brakes (10K HD).

Dx Part No.	Quantity	Parts Description
006-062-00	2	Nut, Flange
006-092-01	2	Nut, Flange
027-039-00	6	Wire Clip
027-050-00	2	Magnet Retainer
033-084-00	2	Spacer, Tubular
047-123-37	1	Actuator Arm Assembly, RH
047-123-38	1	Actuator Arm Assembly, LH
059-572-00	1	Instruction Sheet
071-455-01	1	Shoe Hold Down Bracket, LH
071-455-02	1	Shoe Hold Down Bracket, RH



## Brake Retrofit Kit

**K71-459-00**

Fits Dexter 12¼" x 5" electric brakes, forward self-adjust; services two brakes (12K-15K).

Dx Part No.	Quantity	Parts Description
006-062-00	2	Nut, Flange
006-092-01	2	Nut, Flange
027-039-00	6	Wire Clip
027-050-00	2	Magnet Retainer
033-084-00	2	Spacer, Tubular
047-123-35	1	Actuator Arm Assembly, RH
047-123-36	1	Actuator Arm Assembly, LH
059-572-00	1	Instruction Sheet
071-455-01	1	Shoe Hold Down Bracket, LH
071-455-02	1	Shoe Hold Down Bracket, RH



## Brake Retrofit Kit

**K71-465-00**

Fits Dexter 12¼" hydraulic brakes, forward self-adjust; services two brakes (8K-15K). Not for brakes with parking feature.

Dx Part No.	Quantity	Parts Description
046-131-01	2	Spring, Extension
046-134-00	1	Adjuster Spring, RH
046-135-00	1	Adjuster Spring, LH
048-019-00	1	Adjuster Screw Assembly, LH
048-020-00	1	Adjuster Screw Assembly, RH
059-578-00	1	Instruction Sheet
071-456-00	2	Bracket, Cable Attachment
071-462-00	2	Adjuster Cable
071-463-00	1	Self Adjusting Lever, RH
071-464-00	1	Self Adjusting Lever, LH



## Brake & Hub-Drum Kit

**K71-509-00**

Converts one idler axle to 7" electric brakes with 4-4.00 BC (2.2K).

Dx Part No.	Quantity	Parts Description
005-101-00	2	Washer, Tang
006-017-00	8	Nut, Hex
006-080-00	8	Nut, Cone 60-deg
008-173-16	2	Hub-Drum, 2.2K, 440, 7" Electric Brake, Cupped & Studded
010-009-00	2	Seal, Grease 1.50 ID
019-002-00	2	Cotter Pin
021-003-00	2	Grease Cap
023-047-00	1	7" x 1 1/4" 2.2K Electric LH
023-048-00	1	7" x 1 1/4" 2.2K Electric RH
031-031-02	4	Bearing Cone (L44649)



## Brake & Hub-Drum Kit

**K71-508-00**

Converts one idler axle to 7" electric brakes with 5-4.50 BC (2.2K).

Dx Part No.	Quantity	Parts Description
005-101-00	2	Washer, Tang
006-017-00	8	Nut, Hex
006-080-00	10	Nut, Cone 60-deg
008-257-05	2	Hub-Drum, 2.2K, 545, 7" Electric Only, Cupped & Studded
010-009-00	2	Seal, Grease 1.50 ID
019-002-00	2	Cotter Pin
021-003-00	2	Grease Cap
023-047-00	1	7" x 1 1/4" 2.2K Electric LH
023-048-00	1	7" x 1 1/4" 2.2K Electric RH
031-031-02	4	Bearing Cone (L44649)



## Brake & Hub-Drum Kit - LH

**K71-510-00**

Converts idler to brake axle; contains 10" electric brakes with 5-4.50 BC hub-drum (3.5K).

Dx Part No.	Quantity	Parts Description
005-023-00	1	Washer, "D"
006-017-00	4	Nut, Hex
006-080-00	5	Nut, Cone 60-deg
006-190-00	1	Nut, Retainer
006-191-00	1	Nut, Hex
008-247-05	1	Hub-Drum, 3.5K, 545, Cupped & Studded
010-019-00	1	Seal, Grease 1.72 ID
021-003-00	1	Grease Cap
023-026-00	1	10" x 2 1/4" 3.5K Electric LH
031-031-02	1	Bearing Cone (L44649)
031-033-02	1	Bearing Cone (L68149)



## Brake & Hub-Drum Kit - RH

**K71-511-00**

Converts idler to brake axle; contains 10" electric brakes with 5-4.50 BC hub-drum (3.5K).

Dx Part No.	Quantity	Parts Description
005-023-00	1	Washer, "D"
006-017-00	4	Nut, Hex
006-080-00	5	Nut, Cone 60-deg
006-190-00	1	Nut, Retainer
006-191-00	1	Nut, Hex
008-247-05	1	Hub-Drum, 3.5K, 545, Cupped & Studded
010-019-00	1	Seal, Grease 1.72 ID
021-003-00	1	Grease Cap
023-027-00	1	10" x 2 1/4" 3.5K Electric RH
031-031-02	1	Bearing Cone (L44649)
031-033-02	1	Bearing Cone (L68149)



## Disc Brake Retrofit Kit - LH or RH

**K71-633-00**

Fits Dexter 3.5K axles; for one brake, LH or RH.

Dx Part No.	Quantity	Parts Description
006-017-00	4	Nut, Hex
008-248-22	1	Hub, 3.5K, 545, Long Stud, Cupped & Studded
010-019-00	1	Seal, Grease 1.72 ID
021-041-02	1	Grease Cap
031-031-02	1	Bearing Cone (L44649)
031-033-02	1	Bearing Cone (L68149)
059-806-00	1	Instruction Sheet
085-001-00	1	Rubber Plug
090-004-01	1	Yoke Assembly, 3.5K
K71-624-00	1	Caliper Replacement Kit, 3.5K
K71-626-00	1	Rotor Replacement Kit, 3.5K



## Disc Brake Retrofit Kit - LH

**K71-638-00**

Fits Dexter 6K axles; for one brake.

Dx Part No.	Quantity	Parts Description
006-193-00	5	Nut, Hex
008-403-05	1	Hub, 6K, 655, Disc Brake, Cupped & Studded
010-036-00	1	Seal, 2.25 ID
021-042-01	1	Grease Cap
031-029-02	1	Bearing Cone (15123)
031-030-02	1	Bearing Cone (25580)
059-815-00	1	Instruction Sheet
070-009-02	1	Rotor, 6K, 655, E-Coated
085-001-00	1	Rubber Plug
088-023-00	1	Thread Locker Sealant, Blue Liquid
090-005-01	1	Yoke Assembly, 6K
091-004-00	2	Brake Pad Assembly
K71-636-00	1	Caliper Replacement Kit, 6K





## Disc Brake Retrofit Kit - RH

**K71-639-00**

Fits Dexter 6K axles; for one brake.

Dx Part No.	Quantity	Parts Description
006-193-00	5	Nut, Hex
008-403-05	1	Hub, 6K, 655, Disc Brake, Cupped & Studded
010-036-00	1	Seal, 2.25
021-042-01	1	Grease Cap
031-029-02	1	Bearing Cone (15123)
031-030-02	1	Bearing Cone (25580)
059-815-00	1	Instruction Sheet
070-009-02	1	Rotor, 6K, 655, E-Coated
085-001-00	1	Rubber Plug
088-023-00	1	Thread Locker Sealant, Blue Liquid
090-005-02	1	Yoke Assembly, 6K
091-004-00	2	Brake Pad Assembly
K71-636-00	1	Caliper Replacement Kit, 6K



## Disc Brake Retrofit Kit - LH

**K71-647-00**

Fits Dexter 6K, 6 bolt axles equipped with Nev-R-Lube (42mm bearing).

Dx Part No.	Quantity	Parts Description
006-193-00	5	Nut, Hex
008-404-80	1	Hub, 6K, 655, Disc Brake, 42MM, Cupped & Studded
021-085-00	1	Grease Cap
059-824-00	1	Instruction Sheet
070-009-02	1	Rotor, 6K, 655, E-Coated
088-023-00	1	Thread Locker Sealant, Blue Liquid
090-006-01	1	Yoke Assembly, 6K
091-004-00	2	Brake Pad Assembly
K71-636-00	1	Caliper Replacement Kit, 6K



## Disc Brake Retrofit Kit - RH

**K71-648-00**

Fits Dexter 6K, 6 bolt axles equipped with Nev-R-Lube (42mm bearing).

Dx Part No.	Quantity	Parts Description
006-193-00	5	Nut, Hex
008-404-80	1	Hub 6K 655 42Mm Disc Brake
021-085-00	1	Grease Cap
059-824-00	1	Instruction Sheet
070-009-02	1	Rotor
088-023-00	1	Thread Locker Sealant, Blue Liquid
090-006-02	1	Yoke Assembly, 6K
091-004-00	2	Brake Pad Assembly
K71-636-00	1	Caliper Replacement Kit, 6K



## Disc Brake Retrofit Kit - LH

**K71-694-00**

Fits Dexter 7K axles; for one brake.

Dx Part No.	Quantity	Parts Description
006-193-00	5	Nut, Hex
059-877-00	1	Instruction Sheet
088-023-00	1	Thread Locker Sealant, Blue Liquid
090-008-01	1	Yoke Assembly, 7K
091-004-00	2	Brake Pad Assembly
K71-693-00	1	Caliper Replacement Kit, 7k



## Disc Brake Retrofit Kit - RH

**K71-695-00**

Fits Dexter 7K axles; for one brake.

Dx Part No.	Quantity	Parts Description
006-193-00	5	Nut, Hex
059-877-00	1	Instruction Sheet
088-023-00	1	Thread Locker Sealant, Blue Liquid
090-008-02	1	Yoke Assembly, 7K
091-004-00	2	Brake Pad Assembly
K71-693-00	1	Caliper Replacement Kit, 7k



## Disc Brake Retrofit Kit

**K71-635-00**

Fits Dexter 8K axles; for one brake.

Dx Part No.	Quantity	Parts Description
005-058-00	4	Washer, Lock
006-129-01	4	Nut, Hex
007-097-00	4	Bolt, Hex
059-808-00	1	Instruction Sheet
070-007-02	1	Rotor, 8K, 865, E-Coated
088-023-00	1	Thread Locker Sealant, Blue Liquid
090-003-01	1	Yoke Assembly, 8K
091-004-00	2	Brake Pad Assembly
K71-630-00	1	Caliper Replacement Kit, 8K

Note: Use K71-635-00 with one of the following hub assemblies (separate kit):

008-399-90	Hub Assembly with 1/16" Studs; Grease; 8-6.50
088-399-91	Hub Assembly with 1/16" Studs; Oil; 8-6.50
008-399-92	Hub Assembly with 5/8" Studs; Grease; 8-6.50
008-399-93	Hub Assembly with 5/8" Studs; Oil; 8-6.50



## Disc Brake Retrofit Kit

**K71-646-00**

Fits Dexter 8K axles equipped with Nev-R-Lube (50mm bearing); LH or RH.

Dx Part No.	Quantity	Parts Description
005-058-00	4	Washer, Lock
006-129-01	4	Nut, Hex
007-097-00	4	Bolt, Hex
059-824-00	1	Instruction Sheet
070-007-02	1	Rotor, 8K, 865, E-Coated
088-023-00	1	Thread Locker Sealant, Blue Liquid
090-007-01	1	Yoke Assembly, 8K
091-004-00	2	Brake Pad Assembly
K71-630-00	1	Caliper Replacement Kit, 8K

Note: Use K71-646-00 with one of the following hub assemblies (separate kit):

008-402-90	Hub Assembly with 1/16" Studs; 8 Bolt
008-402-91	Hub Assembly with 5/8" Studs; 8 Bolt

# Complete Hub & Hub-Drum Kits



## Hub Kit

**K08-091-90**

For 2K idler axle, 4-4.00 BC, tapped holes, 1/2"-20, grease lube.

Dx Part No.	Quantity	Parts Description
007-040-00	4	Bolt, 60-deg
008-091-04	1	Hub, 2.2K, 440, Tapped w/Cups
010-009-00	1	Seal, Grease 1.50 ID
021-003-00	1	Grease Cap
031-031-02	2	Bearing Cone (L44649)
059-831-00	1	Instruction Sheet



## Hub Kit

**K08-091-91**

For 2K idler axle, 4-4.00 BC, studed 1/2"-20, grease lube.

Dx Part No.	Quantity	Parts Description
006-080-00	4	Nut, Cone 60-deg
008-091-05	1	Hub, 2.2K, 440, Cupped & Studed
010-009-00	1	Seal, Grease 1.50 ID
021-003-00	1	Grease Cap
031-031-02	2	Bearing Cone (L44649)
059-831-00	1	Instruction Sheet



## Hub-Drum Kit

**K08-257-90**

For 2K axle, 5-4.50 BC, studed 1/2"-20, seal, standard grease cap.

Dx Part No.	Quantity	Parts Description
007-040-00	5	Bolt, 60-deg
008-257-04	1	Hub-Drum, 2.2K, 545, 7" Electric Brake, Tapped w/Cups
010-009-00	1	Seal, Grease 1.50 ID
021-003-00	1	Grease Cap
031-031-02	2	Bearing Cone (L44649)
059-831-00	1	Instruction Sheet



## Hub-Drum Kit

**K08-257-91**

For 2K electric brake axle, 5-4.50 BC, studed 1/2"-20, seal, standard grease cap.

Dx Part No.	Quantity	Parts Description
006-080-00	5	Nut, Cone 60-deg
008-257-05	1	Hub-Drum, 2.2K, 545, 7" Electric Brake, Cupped & Studed
010-009-00	1	Seal, Grease 1.50 ID
021-003-00	1	Grease Cap
031-031-02	2	Bearing Cone (L44649)
059-831-00	1	Instruction Sheet



## Hub Kit

**K08-259-91**

For 2K axle, 5-4.50 BC, studed 1/2"-20, seal, standard grease cap, for 8"-12" wheels only.

Dx Part No.	Quantity	Parts Description
006-080-00	5	Nut, Cone 60-deg
008-259-05	1	Hub, 2.2K, 545, 5.50" Dia. Hub Face, Cupped & Studed
010-009-00	1	Seal, Grease 1.50 ID
021-003-00	1	Grease Cap
031-031-02	2	Bearing Cone (L44649)
059-831-00	1	Instruction Sheet



## Hub Kit

**K08-259-92**

For 2K axle; 5-4.50 BC, studed 1/2"-20, seal, ecoat, E-Z Lube grease cap, for 8"-12" wheels only.

Dx Part No.	Quantity	Parts Description
006-080-00	5	Nut, Cone 60-deg
006-190-00	1	Nut, Retainer
006-191-00	1	Nut, Hex
008-259-10	1	Hub, 2.2K, 545, 5.50" Dia. Hub Face, E-Coat, Cupped & Studed
010-060-00	1	Seal, Oil 1.50 ID
021-041-01	1	Grease Cap
031-031-02	1	Bearing Cone (L44649)
059-831-00	1	Instruction Sheet
085-001-00	1	Rubber Plug



## Hub Kit

**K08-258-91**

For 2K axle, 5-4.50 BC, studed 1/2"-20, seal, standard grease cap, for 13"-15" wheels only.

Dx Part No.	Quantity	Parts Description
006-080-00	5	Nut, Cone 60-deg
008-258-05	1	Hub, 2.2K, 545, 6.50" Dia. Hub Face, Cupped & Studed
010-009-00	1	Seal, Grease 1.50 ID
021-003-00	1	Grease Cap
031-031-02	2	Bearing Cone (L44649)
059-831-00	1	Instruction Sheet



## Hub Kit

**K08-258-92**

For 2K axle, 5-4.50 BC, studed 1/2"-20, seal, ecoat, E-Z Lube grease cap, for 13"-15" wheels only.

Dx Part No.	Quantity	Parts Description
006-080-00	5	Nut, Cone 60-deg
006-190-00	1	Nut, Retainer
006-191-00	1	Nut, Hex
008-258-10	1	Hub, 2.2K, 545, 6.50" Dia. Hub Face, E-Coat, Cupped & Studed
010-060-00	1	Seal, Oil 1.50 ID
021-041-01	1	Grease Cap
031-031-02	1	Bearing Cone (L44649)
059-831-00	1	Instruction Sheet
085-001-00	1	Rubber Plug

# Complete Hub & Hub-Drum Kits



## Hub-Drum Kit

**K08-418-90**

For 3K axle, 5-4.50 BC, studded 1/2"-20, 1.718 seal, standard grease cap.

Dx Part No.	Quantity	Parts Description
006-080-00	5	Nut, Cone 60-deg
008-418-02	1	Hub-Drum, 3K, 545, Cupped & Studded
010-019-00	1	Seal, Grease 1.72 ID
021-003-00	1	Grease Cap
031-031-02	1	Bearing Cone (L44649)
031-032-02	1	Bearing Cone (LM67048)
059-831-00	1	Instruction Sheet



## Hub-Drum Kit

**K08-418-91**

For 3K axle, 5-4.50 BC, studded 1/2"-20, 1.718 seal, E-Z Lube grease cap.

Dx Part No.	Quantity	Parts Description
006-080-00	5	Nut, Cone 60-deg
006-190-00	1	Nut, Retainer
006-191-00	1	Nut, Hex
008-418-02	1	Hub-Drum, 3K, 545, Cupped & Studded
010-019-00	1	Seal, Grease 1.72 ID
021-041-01	1	Grease Cap
031-031-02	1	Bearing Cone (L44649)
031-032-02	1	Bearing Cone (LM67048)
059-831-00	1	Instruction Sheet
085-001-00	1	Rubber Plug



## Hub-Drum Kit

**K08-247-90**

For 3.5K axle, 5-4.50 BC studded 1/2"-20, 1.718 seal, standard grease cap.

Dx Part No.	Quantity	Parts Description
006-080-00	5	Nut, Cone 60-deg
008-247-05	1	Hub-Drum, 3.5K, 545, Cupped & Studded
010-019-00	1	Seal, Grease 1.72 ID
021-003-00	1	Grease Cap
031-031-02	1	Bearing Cone (L44649)
031-033-02	1	Bearing Cone (L68149)
059-831-00	1	Instruction Sheet



## Hub-Drum Kit

**K08-247-94**

For 3.5K axle, 5-4.50 BC, studded 1/2"-20, 1.718 seal, E-Z Lube grease cap.

Dx Part No.	Quantity	Parts Description
006-080-00	5	Nut, Cone 60-deg
006-190-00	1	Nut, Retainer
006-191-00	1	Nut, Hex
008-247-05	1	Hub-Drum, 3.5K, 545, Cupped & Studded
010-019-00	1	Seal, Grease 1.72 ID
021-041-01	1	Grease Cap
031-031-02	1	Bearing Cone (L44649)
031-033-02	1	Bearing Cone (L68149)
059-831-00	1	Instruction Sheet
085-001-00	1	Rubber Plug





## Hub Kit

**K08-248-90**

For 3.5K idler axle, 5-4.50 BC, studed 1/2"-20, 1.718 seal, standard grease cap.

Dx Part No.	Quantity	Parts Description
006-080-00	5	Nut, Cone 60-deg
008-248-05	1	Hub, 3.5K, 545, Cupped & Studed
010-019-00	1	Seal, Grease 1.72 ID
021-003-00	1	Grease Cap
031-031-02	1	Bearing Cone (L44649)
031-033-02	1	Bearing Cone (L68149)
059-831-00	1	Instruction Sheet



## Hub Kit

**K08-248-95**

For 3.5K axle, 5-4.50 BC, studed 1/2"-20, 1.718 seal, E-Z Lube grease cap.

Dx Part No.	Quantity	Parts Description
006-080-00	5	Nut, Cone 60-deg
006-190-00	1	Nut, Retainer
006-191-00	1	Nut, Hex
008-248-05	1	Hub, 3.5K, 545, Cupped & Studed
010-019-00	1	Seal, Grease 1.72 ID
021-041-01	1	Grease Cap
031-031-02	1	Bearing Cone (L44649)
031-033-02	1	Bearing Cone (L68149)
059-831-00	1	Instruction Sheet
085-001-00	1	Rubber Plug



## Hub Kit

**K08-248-96**

For 3.5K axle, 5-4.50 BC, studed 1/2"-20, 1.718 seal, ecoat, E-Z Lube grease cap.

Dx Part No.	Quantity	Parts Description
006-080-00	5	Nut, Cone 60-deg
006-190-00	1	Nut, Retainer
006-191-00	1	Nut, Hex
008-248-19	1	Hub, 3.5K, 545, E-Coat, Cupped & Studed
010-019-00	1	Seal, Grease 1.72 ID
021-041-01	1	Grease Cap
031-031-02	1	Bearing Cone (L44649)
031-033-02	1	Bearing Cone (L68149)
059-831-00	1	Instruction Sheet
085-001-00	1	Rubber Plug



## Hub Kit

**K08-248-9D**

For 3.5K axle, 5-4.50 BC, studed 1/2"-20, 1.718 seal, ecoat, standard grease cap, with grease seal and cap only.

Dx Part No.	Quantity	Parts Description
006-080-00	5	Nut, Cone 60-deg
008-248-05	1	Hub, 3.5K, 545, Cupped & Studed
010-019-00	1	Seal, Grease 1.72 ID
021-003-00	1	Grease Cap
059-831-00	1	Instruction Sheet



# Complete Hub & Hub-Drum Kits



## Hub-Drum Kit

**K08-247-93**

For 3.5K axle, 5-4.75 BC, studded 1/2"-20, 1.718 seal, standard grease cap.

Dx Part No.	Quantity	Parts Description
006-080-00	5	Nut, Cone 60-deg
008-247-12	1	Hub-Drum, 3.5K, 5475, Cupped & Studded
010-019-00	1	Seal, Grease 1.72 ID
021-003-00	1	Grease Cap
031-031-02	1	Bearing Cone (L44649)
031-033-02	1	Bearing Cone (L68149)
059-831-00	1	Instruction Sheet



## Hub Kit

**K08-248-92**

For 3.5K idler axle, 5-4.75 BC, studded 1/2"-20, 1.718 seal, standard grease cap.

Dx Part No.	Quantity	Parts Description
006-080-00	5	Nut, Cone 60-deg
008-248-10	1	Hub, 3.5K, 5475, Cupped & Studded
010-019-00	1	Seal, Grease 1.72 ID
021-003-00	1	Grease Cap
031-031-02	1	Bearing Cone (L44649)
031-033-02	1	Bearing Cone (L68149)
059-831-00	1	Instruction Sheet



## Hub-Drum Kit

**K08-249-90**

For 3.5K axle, 5-5.50 BC, studded 1/2"-20, 1.718 seal, standard grease cap.

Dx Part No.	Quantity	Parts Description
006-080-00	5	Nut, Cone 60-deg
008-249-05	1	Hub-Drum, 3.5K, 555, Cupped & Studded
010-019-00	1	Seal, Grease 1.72 ID
021-003-00	1	Grease Cap
031-031-02	1	Bearing Cone (L44649)
031-033-02	1	Bearing Cone (L68149)
059-831-00	1	Instruction Sheet



## Hub-Drum Kit

**K08-249-91**

For 3.5K axle, 5-5.00 BC, studded 1/2"-20, 1.718 seal, standard grease cap.

Dx Part No.	Quantity	Parts Description
006-080-00	5	Nut, Cone 60-deg
008-249-07	1	Hub-Drum, 3.5K, 550, Cupped & Studded
010-019-00	1	Seal, Grease 1.72 ID
021-003-00	1	Grease Cap
031-031-02	1	Bearing Cone (L44649)
031-033-02	1	Bearing Cone (L68149)
059-831-00	1	Instruction Sheet



## Hub-Drum Kit

**K08-250-90**

For 3.5K axle, 6-5.50 BC, studded 1/2"-20, 1.718 seal, standard grease cap.

Dx Part No.	Quantity	Parts Description
006-080-00	6	Nut, Cone 60-deg
008-250-05	1	Hub-Drum, 3.5K, 655, Cupped & Studded
010-019-00	1	Seal, Grease 1.72
021-003-00	1	Grease Cap
031-031-02	1	Bearing Cone (L44649)
031-033-02	1	Bearing Cone (L68149)
059-831-00	1	Instruction Sheet



## Hub-Drum Kit

**K08-250-91**

For 3.5K axle, 6-5.50 BC, studded 1/2"-20, 1.718 seal, E-Z Lube grease cap.

Dx Part No.	Quantity	Parts Description
006-080-00	6	Nut, Cone 60-deg
006-190-00	1	Nut, Retainer
006-191-00	1	Nut, Hex
008-250-05	1	Hub-Drum, 3.5K, 655, Cupped & Studded
010-019-00	1	Seal, Grease 1.72 ID
021-041-01	1	Grease Cap
031-031-02	1	Bearing Cone (L44649)
031-033-02	1	Bearing Cone (L68149)
059-831-00	1	Instruction Sheet
085-001-00	1	Rubber Plug



## Hub Kit

**K08-251-90**

For 3.5K idler axle, 6-5.50 BC, studded 1/2"-20, 1.718 seal, standard grease cap.

Dx Part No.	Quantity	Parts Description
006-080-00	6	Nut, Cone 60-deg
008-251-05	1	Hub, 3.5K 655, Cupped & Studded
010-019-00	1	Seal, Grease 1.72 ID
021-003-00	1	Grease Cap
031-031-02	1	Bearing Cone (L44649)
031-033-02	1	Bearing Cone (L68149)
059-831-00	1	Instruction Sheet



## Hub Kit

**K08-256-90**

For 3.5K idler axle, 5-5.50 BC, studded 1/2"-20, 1.718 seal, standard grease cap.

Dx Part No.	Quantity	Parts Description
006-080-00	5	Nut, Cone 60-deg
008-256-05	1	Hub, 3.5K, 550, Cupped & Studded
010-019-00	1	Seal, Grease 1.72 ID
021-003-00	1	Grease Cap
031-031-02	1	Bearing Cone (L44649)
031-033-02	1	Bearing Cone (L68149)
059-831-00	1	Instruction Sheet

# Complete Hub & Hub-Drum Kits



## Hub Kit

**K08-256-91**

For 3.5K idler axle, 5-5.00 BC, studed 1/2"-20, 1.718 seal, standard grease cap.

Dx Part No.	Quantity	Parts Description
006-080-00	5	Nut, Cone 60-deg
008-256-07	1	Hub, 3.5K, 550, Cupped & Studed
010-019-00	1	Seal, Grease 1.72 ID
021-003-00	1	Grease Cap
031-031-02	1	Bearing Cone (L44649)
031-033-02	1	Bearing Cone (L68149)
059-831-00	1	Instruction Sheet



## Hub-Drum Kit

**K08-426-90**

For 4K axle, 5-4.50 BC, studed 1/2"-20, 1.718 seal, standard grease cap.

Dx Part No.	Quantity	Parts Description
006-080-00	5	Nut, Cone 60-deg
008-426-05	1	Hub-Drum, 4K, 545, Cupped & Studed
010-019-00	1	Seal, Grease 1.72 ID
021-003-00	1	Grease Cap
031-031-02	1	Bearing Cone (L44649)
031-033-02	1	Bearing Cone (L68149)
059-831-00	1	Instruction Sheet



## Hub-Drum Kit

**K08-426-91**

For 4K axle, 5-4.50 BC, studed 1/2"-20, 1.718 seal, E-Z Lube grease cap.

Dx Part No.	Quantity	Parts Description
006-080-00	5	Nut, Cone 60-deg
006-190-00	1	Nut, Retainer
006-191-00	1	Nut, Hex
008-426-05	1	Hub-Drum, 4K, 545, Cupped & Studed
010-019-00	1	Seal, Grease 1.72 ID
021-041-01	1	Grease Cap
031-031-02	1	Bearing Cone (L44649)
031-033-02	1	Bearing Cone (L68149)
059-831-00	1	Instruction Sheet
085-001-00	1	Rubber Plug



## Hub-Drum Kit

**K08-407-90**

For 4.4K axle, 6-5.50 BC, studed 1/2"-20, 1.718 seal, E-Z Lube grease cap.

Dx Part No.	Quantity	Parts Description
005-023-00	1	Washer, "D"
006-080-00	6	Nut, Cone 60-deg
006-176-00	1	Nut, Slotted
006-190-00	1	Nut, Retainer
006-191-00	1	Nut, Hex
008-407-05	1	Hub-Drum, 4.4K, 655, Cupped & Studed
010-019-00	1	Seal, Grease 1.72 ID
019-002-00	1	Cotter Pin
021-001-00	1	Grease Cap
021-042-01	1	Grease Cap
031-032-02	1	Bearing Cone (LM67048)
031-033-02	1	Bearing Cone (L68149)
059-831-00	1	Instruction Sheet
085-001-00	1	Rubber Plug



## Hub-Drum Kit

**K08-201-90**

For 5.2K axle, 6-5.50 BC, studed 1/2"-20, 2.125 seal, standard grease cap.

Dx Part No.	Quantity	Parts Description
006-080-00	6	Nut, Cone 60-deg
008-201-05	1	Hub-Drum, 5.2K, 655, LM67010 Outer, Cupped & Studed
010-010-00	1	Seal, Oil 2.125 ID
021-001-00	1	Grease Cap
031-030-02	1	Bearing Cone (25580)
031-032-02	1	Bearing Cone (LM67048)
059-831-00	1	Instruction Sheet



## Hub-Drum Kit

**K08-201-94**

For 5.2K axle, 6-5.50 BC, studed 1/2"-20, 2.125 seal, E-Z Lube grease cap.

Dx Part No.	Quantity	Parts Description
006-080-00	6	Nut, Cone 60-deg
006-190-00	1	Nut, Retainer
006-191-00	1	Nut, Hex
008-201-05	1	Hub-Drum, 5.2K, 655, LM67010 Outer, Cupped & Studed
010-010-00	1	Seal, Oil 2.125 ID
021-042-01	1	Grease Cap
031-030-02	1	Bearing Cone (25580)
031-032-02	1	Bearing Cone (LM67048)
059-831-00	1	Instruction Sheet
085-001-00	1	Rubber Plug

# Complete Hub & Hub-Drum Kits



## Hub-Drum Kit

**K08-201-97**

For 5.2K axle, 6-5.50 BC, studded 1/2"-20, 2.25 seal, standard grease cap.

Dx Part No.	Quantity	Parts Description
006-080-00	6	Nut, Cone 60-deg
008-201-05	1	Hub-Drum, 5.2K, 655, LM67010 Outer, Cupped & Studded
010-036-00	1	Seal, 2.25 ID
021-001-00	1	Grease Cap
031-030-02	1	Bearing Cone (25580)
031-032-02	1	Bearing Cone (LM67048)
059-831-00	1	Instruction Sheet



## Hub-Drum Kit

**K08-201-98**

For 5.2K axle, 6-5.50 BC, studded 1/2"-20, 2.25 seal, E-Z Lube grease cap.

Dx Part No.	Quantity	Parts Description
006-080-00	6	Nut, Cone 60-deg
006-190-00	1	Nut, Retainer
006-191-00	1	Nut, Hex
008-201-05	1	Hub-Drum, 5.2K, 655, LM67010 Outer, Cupped & Studded
010-036-00	1	Seal, 2.25 ID
021-042-01	1	Grease Cap
031-030-02	1	Bearing Cone (25580)
031-032-02	1	Bearing Cone (LM67048)
059-831-00	1	Instruction Sheet
085-001-00	1	Rubber Plug



## Hub Kit

**K08-213-90**

For 5.2K idler axle, 6-5.50 BC, studded 1/2"-20, 2.125 seal, standard grease cap.

Dx Part No.	Quantity	Parts Description
006-080-00	6	Nut, Cone 60-deg
008-213-05	1	Hub, 5.2K, 655, LM67010 Outer, Cupped & Studded
010-010-00	1	Seal, Oil 2.125 ID
021-001-00	1	Grease Cap
031-030-02	1	Bearing Cone (25580)
031-032-02	1	Bearing Cone (LM67048)
059-831-00	1	Instruction Sheet



## Wheel-Drum Kit

**K08-174-90**

For demountable 7K UTG axle, studded, 2.125 seal.

Dx Part No.	Quantity	Parts Description
006-005-00	5	Nut, Hex
008-174-05	1	Wheel-Drum, 7K, UTG, Cupped & Studded
010-010-00	1	Seal 2.125 ID
015-002-00	5	Rim Clamp
021-001-00	1	Grease Cap
031-029-02	1	Bearing Cone Inner (15123)
031-030-02	1	Bearing Cone Outer (25580)
059-831-00	1	Instruction Sheet



### Wheel-Drum Kit

**K08-174-93**

For demountable 7K UTG axle, studded, 2.25 seal.

Dx Part No.	Quantity	Parts Description
006-005-00	5	Nut, Hex
008-174-05	1	Wheel-Drum, 7K, UTG, Cupped & Studded
010-036-00	1	Seal 2.25 ID
015-002-00	5	Rim Clamp
021-001-00	1	Grease Cap
031-029-02	1	Bearing Cone Inner (15123)
031-030-02	1	Bearing Cone Outer (25580)
059-831-00	1	Instruction Sheet



### Hub-Drum Kit

**K08-201-91**

For 6K axle, 6-5.50 BC, studded 1/2"-20, 2.125 seal, standard grease cap.

Dx Part No.	Quantity	Parts Description
006-080-00	6	Nut, Cone 60-deg
008-201-09	1	Hub-Drum, 6K, 15245 Outer, Cupped & Studded
010-010-00	1	Seal, Oil 2.125 ID
021-001-00	1	Grease Cap
031-029-02	1	Bearing Cone (15123)
031-030-02	1	Bearing Cone (25580)
059-831-00	1	Instruction Sheet



### Hub-Drum Kit

**K08-201-95**

For 6K axle, 6-5.50 BC, studded 1/2"-20, 2.125 seal, E-Z Lube grease cap.

Dx Part No.	Quantity	Parts Description
006-080-00	6	Nut, Cone 60-deg
006-190-00	1	Nut, Retainer
006-191-00	1	Nut, Hex
008-201-09	1	Hub-Drum, 6K, 15245 Outer, Cupped & Studded
010-010-00	1	Seal, Oil 2.125 ID
021-042-01	1	Grease Cap
031-029-02	1	Bearing Cone (15123)
031-030-02	1	Bearing Cone (25580)
059-831-00	1	Instruction Sheet
085-001-00	1	Rubber Plug



### Hub-Drum Kit

**K08-201-9A**

For 6K axle, 6-5.50 BC, studded 1/2"-20, 2.25 seal, standard grease cap.

Dx Part No.	Quantity	Parts Description
006-080-00	6	Nut, Cone 60-deg
008-201-09	1	Hub-Drum, 6K, 15245 Outer, Cupped & Studded
010-036-00	1	Seal, 2.25 ID
021-001-00	1	Grease Cap
031-029-02	1	Bearing Cone (15123)
031-030-02	1	Bearing Cone (25580)
059-831-00	1	Instruction Sheet



# Complete Hub & Hub-Drum Kits



## Hub Kit

**K08-213-9C**

For 6K idler axle, 6-5.50 BC, studded 1/2"-20, 2.25 seal, standard grease cap.

Dx Part No.	Quantity	Parts Description
006-080-00	6	Nut, Cone 60-deg
008-213-09	1	Hub, 6K, 655, 15245 Outer, Cupped & Studded
010-036-00	1	Seal, 2.25 ID
021-001-00	1	Grease Cap
031-029-02	1	Bearing Cone (15123)
031-030-02	1	Bearing Cone (25580)
059-831-00	1	Instruction Sheet



## Hub-Drum Kit

**K08-219-90**

For 7K axle, 8-6.50 BC, studded 1/2"-20, 2.125 seal, standard grease cap.

Dx Part No.	Quantity	Parts Description
006-080-00	8	Nut, Cone 60-deg
008-219-04	1	Hub-Drum, 7K, 865, 1/2"-20, Cupped & Studded
010-010-00	1	Seal, Oil 2.125 ID
021-039-00	1	Grease Cap
031-017-02	1	Bearing Cone (14125A)
031-030-02	1	Bearing Cone (25580)
059-831-00	1	Instruction Sheet



## Hub Kit

**K08-231-92**

For 7K axle, 8-6.50 BC, studded 1/2"-20, 2.125 seal, standard grease cap.

Dx Part No.	Quantity	Parts Description
006-080-00	8	Nut, Cone 60-deg
008-231-09	1	Hub, 7K, 865, 1/2"-20, Cupped & Studded
010-010-00	1	Seal, Oil 2.125 ID
021-039-00	1	Grease Cap
031-017-02	1	Bearing Cone (14125A)
031-030-02	1	Bearing Cone (25580)
059-831-00	1	Instruction Sheet



## Hub-Drum Kit

**K08-219-91**

For 7K axle, 8-6.50 BC, studded 9/16"-18, 2.125 seal, standard grease cap.

Dx Part No.	Quantity	Parts Description
006-053-00	8	Nut, Cone 60-deg
008-219-13	1	Hub-Drum, 7K, 865, 9/16"-18, Cupped & Studded
010-010-00	1	Seal, Oil 2.125 ID
021-039-00	1	Grease Cap
031-017-02	1	Bearing Cone (14125A)
031-030-02	1	Bearing Cone (25580)
059-831-00	1	Instruction Sheet



## Hub-Drum Kit

**K08-219-96**

For 7K axle, 8-6.50 BC, studded 1/2"-20, 2.125 seal, E-Z Lube grease cap.

Dx Part No.	Quantity	Parts Description
006-080-00	8	Nut, Cone 60-deg
006-190-00	1	Nut, Retainer
006-191-00	1	Nut, Hex
008-219-04	1	Hub-Drum, 7K, 865, 1/2"-20, Cupped & Studded
010-010-00	1	Seal, Oil 2.125 ID
021-043-01	1	Grease Cap
031-017-02	1	Bearing Cone (14125A)
031-030-02	1	Bearing Cone (25580)
059-831-00	1	Instruction Sheet
085-001-00	1	Rubber Plug



## Hub-Drum Kit

**K08-219-9C**

For 7K axle, 8-6.50 BC, studded 9/16"-18, 2.25 seal, E-Z Lube grease cap.

Dx Part No.	Quantity	Parts Description
006-053-00	8	Nut, Cone 60-deg
006-190-00	1	Nut, Retainer
006-191-00	1	Nut, Hex
008-219-13	1	Hub-Drum, 7K, 865, 9/16"-18, Cupped & Studded
010-036-00	1	Seal, 2.25 ID
021-043-01	1	Grease Cap
031-017-02	1	Bearing Cone (14125A)
031-030-02	1	Bearing Cone (25580)
059-831-00	1	Instruction Sheet
085-001-00	1	Rubber Plug



## Hub-Drum Kit

**K08-219-9D**

For 7K axle, 8-6.50 BC, studded 1/2"-20, 2.25 seal, standard grease cap.

Dx Part No.	Quantity	Parts Description
006-080-00	8	Nut, Cone 60-deg
008-219-04	1	Hub-Drum, 7K, 865, 1/2"-20, Cupped & Studded
010-036-00	1	Seal, 2.25 ID
021-039-00	1	Grease Cap
031-017-02	1	Bearing Cone (14125A)
031-030-02	1	Bearing Cone (25580)
059-831-00	1	Instruction Sheet



## Hub-Drum Kit

**K08-219-9B**

For 7K axle, 8-6.50 BC, studded, 1/2"-20, 2.25 seal, E-Z Lube grease cap, 4.75 pilot diameter.

Dx Part No.	Quantity	Parts Description
006-080-00	8	Nut, Cone 60-deg
006-190-00	1	Nut, Retainer
006-191-00	1	Nut, Hex
008-219-04	1	Hub-Drum, 7K, 865, 1/2"-20, Cupped & Studded
010-036-00	1	Seal, 2.25 ID
021-043-01	1	Grease Cap
031-017-02	1	Bearing Cone Outer (14125A)
031-030-02	1	Bearing Cone Inner (25580)
059-831-00	1	Instruction Sheet
085-001-00	1	Rubber Plug

# Complete Hub & Hub-Drum Kits



## Hub Kit

**K08-231-9B**

For 7K axle, 8-6.50 BC, studded, 9/16"-18, 2.25 seal, E-Z Lube grease cap, 4.75 pilot diameter.

Dx Part No.	Quantity	Parts Description
006-053-00	8	Nut, Cone 60-deg
006-190-00	1	Nut, Retainer
006-191-00	1	Nut, Hex
008-231-18	1	Hub, 7K, 865, 9/16"-18, Cupped & Studded
010-036-00	1	Seal, 2.25 ID
021-043-01	1	Grease Cap
031-017-02	1	Bearing Cone (14125A)
031-030-02	1	Bearing Cone (25580)
059-831-00	1	Instruction Sheet
085-001-00	1	Rubber Plug



## Hub-Drum Kit

**K08-393-90**

For 7.2K axle, 8-6.50 BC, studded 9/16"-18, seal, E-Z Lube grease cap, 4.75 pilot diameter.

Dx Part No.	Quantity	Parts Description
006-053-00	8	Nut, Cone 60-deg
006-190-00	1	Nut, Retainer
006-191-00	1	Nut, Hex
008-393-04	1	Hub-Drum, 7.2K, 865, 9/16"-18, Grease, Cupped & Studded
010-036-00	1	Seal, 2.25 ID
021-043-01	1	Grease Cap
031-028-02	1	Bearing Cone (02475)
031-030-02	1	Bearing Cone (25580)
059-831-00	1	Instruction Sheet
085-001-00	1	Rubber Plug



## Hub-Drum Kit

**K08-285-97**

For 8K axle, 8-6.50 BC, studded 5/8"-18, seal, grease cap, 4.75 pilot diameter.

Dx Part No.	Quantity	Parts Description
006-058-00	8	Nut, Flange
008-285-08	1	Hub-Drum, 8K, 865, 5/8"-18, Grease, Cupped & Studded
010-036-00	1	Seal, 2.25 ID
021-039-00	1	Grease Cap
031-028-02	1	Bearing Cone (02475)
031-030-02	1	Bearing Cone (25580)
059-831-00	1	Instruction Sheet



## Hub-Drum Kit

**K08-285-9F**

For 8K axle, 8-6.50 BC, studded 5/8"-18, seal, oil cap, 4.75 pilot diameter.

Dx Part No.	Quantity	Parts Description
006-058-00	8	Nut, Flange
006-190-00	1	Nut, Retainer
006-191-00	1	Nut, Hex
008-285-10	1	Hub-Drum, 8K, 865, 5/8"-18, Oil, Cupped & Studded
010-036-00	1	Seal, 2.25 ID
010-045-00	1	O-Ring
021-035-01	1	Oil Cap, Black
031-028-02	1	Bearing Cone (02475)
031-030-02	1	Bearing Cone (25580)
046-032-00	1	Rubber Plug
059-831-00	1	Instruction Sheet



## Hub-Drum Kit

**K08-285-9G**

For 8K axle, 8-6.50 BC, studded 5/8"-18, seal, oil cap, 4.75 pilot diameter, ABS.

Dx Part No.	Quantity	Parts Description
006-058-00	8	Nut, Flange
006-190-00	1	Nut, Retainer
006-191-00	1	Nut, Hex
008-285-14	1	Hub-Drum, 8K, 865, 5/8"-18, ABS, Oil, Cupped & Studded
010-036-00	1	Seal, 2.25 ID
010-045-00	1	O-Ring
021-035-01	1	Oil Cap, Black
031-028-02	1	Bearing Cone (02475)
031-030-02	1	Bearing Cone (25580)
046-032-00	1	Rubber Plug
059-831-00	1	Instruction Sheet



## Hub-Drum Kit

**K08-285-90**

For 8K axle, 8-6.50 BC, studded 5/8"-18, oil seal, oil cap, 4.75 pilot diameter.

Dx Part No.	Quantity	Parts Description
006-109-00	8	Nut, Cone 90-deg
008-285-10	1	Hub-Drum, 8K, 865, 5/8"-18, Oil, Cupped & Studded
010-045-00	1	O-Ring
010-063-00	1	Seal, Oil 2.25 ID
021-035-00	1	Oil Cap
031-028-02	1	Bearing Cone (02475)
031-030-02	1	Bearing Cone (25580)
046-032-00	1	Rubber Plug
059-831-00	1	Instruction Sheet

# Complete Hub & Hub-Drum Kits



## Hub-Drum Kit

**K08-285-92**

For 8K axle, 8-6.50 BC, studded 1/16"-18, oil seal, oil cap, 4.75 pilot diameter.

Dx Part No.	Quantity	Parts Description
006-053-00	8	Nut, Cone 60-deg
008-285-09	1	Hub-Drum, 8K, 865, 1/16"-18, Oil, Cupped & Studded
010-045-00	1	O-Ring
010-063-00	1	Seal, Oil 2.25 ID
021-035-00	1	Oil Cap
031-028-02	1	Bearing Cone (02475)
031-030-02	1	Bearing Cone (25580)
046-032-00	1	Rubber Plug
059-831-00	1	Instruction Sheet



## Hub-Drum Kit

**K08-285-93**

For 8K axle, 8-6.50 BC, studded 5/8"-18, oil seal, oil cap, 4.75 pilot diameter.

Dx Part No.	Quantity	Parts Description
006-058-00	8	Nut, Flange
008-285-10	1	Hub-Drum, 8K, 865, 5/8"-18, Oil, Cupped & Studded
010-045-00	1	O-Ring
010-063-00	1	Seal, Oil 2.25 ID
021-035-00	1	Oil Cap
031-028-02	1	Bearing Cone (02475)
031-030-02	1	Bearing Cone (25580)
046-032-00	1	Rubber Plug
059-831-00	1	Instruction Sheet



## Hub-Drum Kit

**K08-285-94**

For 8K axle, 8-6.50 BC, studded 1/16"-18, seal, standard grease cap, 4.75 pilot diameter.

Dx Part No.	Quantity	Parts Description
006-053-00	8	Nut, Cone 60-deg
008-285-11	1	Hub-Drum, 8K, 865, 1/16"-18, Grease, Cupped & Studded
010-036-00	1	Seal, 2.25 ID
021-039-00	1	Grease Cap
031-028-02	1	Bearing Cone (02475)
031-030-02	1	Bearing Cone (25580)
059-831-00	1	Instruction Sheet



## Hub-Drum Kit

**K08-285-95**

For 8K axle, 8-6.50 BC, studded 1/16"-18, seal, E-Z Lube grease cap, 4.75 pilot diameter.

Dx Part No.	Quantity	Parts Description
006-053-00	8	Nut, Cone 60-deg
006-190-00	1	Nut, Retainer
006-191-00	1	Nut, Hex
008-285-11	1	Hub-Drum, 8K, 865, 1/16"-18, Grease, Cupped & Studded
010-036-00	1	Seal, 2.25 ID
021-043-01	1	Grease Cap
031-028-02	1	Bearing Cone (02475)
031-030-02	1	Bearing Cone (25580)
059-831-00	1	Instruction Sheet
085-001-00	1	Rubber Plug





## Hub-Drum Kit

**K08-285-96**

For 8K axle, 8-6.50 BC, studed 5/8"-18, seal, E-Z Lube grease cap, 4.75 pilot diameter.

Dx Part No.	Quantity	Parts Description
006-109-00	8	Nut, Cone 90-deg
006-190-00	1	Nut, Retainer
006-191-00	1	Nut, Hex
008-285-08	1	Hub-Drum, 8K, 865, 5/8"-18, Grease, Cupped & Studed
010-036-00	1	Seal, 2.25 ID
021-043-01	1	Grease Cap
031-028-02	1	Bearing Cone (02475)
031-030-02	1	Bearing Cone (25580)
059-831-00	1	Instruction Sheet
085-001-00	1	Rubber Plug



## Hub Kit

**K08-399-91**

For 8K disc brake axle, 8-6.50 BC, studed 5/8"-18, seal, oil cap, 4.75 pilot diameter.

Dx Part No.	Quantity	Parts Description
006-058-00	8	Nut, Flange
008-399-08	1	Hub, 8K, 865, Disc Brake, 5/8"-18, Oil, Cupped & Studed
010-036-00	1	Seal, 2.25 ID
010-045-00	1	O-Ring
021-035-01	1	Oil Cap, Black
031-028-02	1	Bearing Cone (02475)
031-030-02	1	Bearing Cone (25580)
046-032-00	1	Rubber Plug
059-831-00	1	Instruction Sheet



## Hub Kit

**K08-287-9A**

For 8K idler axle, 8-6.50 BC, studed 5/8"-18, seal, grease cap, 4.75 pilot diameter.

Dx Part No.	Quantity	Parts Description
006-109-00	8	Nut, Cone 90-deg
008-287-07	1	Hub, 8K, 865 5/8"-18, Grease, Cupped & Studed
010-036-00	1	Seal, 2.25 ID
021-039-00	1	Grease Cap
031-028-02	1	Bearing Cone (02475)
031-030-02	1	Bearing Cone (25580)
059-831-00	1	Instruction Sheet



## Hub Kit

**K08-287-9B**

For 8K idler axle, 8-6.50 BC, studed 5/8"-18, seal, E-Z Lube grease cap, 4.75 pilot diameter.

Dx Part No.	Quantity	Parts Description
006-109-00	8	Nut, Cone 90-deg
006-190-00	1	Nut, Retainer
006-191-00	1	Nut, Hex
008-287-10	1	Hub, 8K, 865, 5/8"-18 Long Stud, Grease, Cupped & Studed
010-036-00	1	Seal, 2.25 ID
021-043-01	1	Grease Cap
031-028-02	1	Bearing Cone (02475)
031-030-02	1	Bearing Cone (25580)
059-831-00	1	Instruction Sheet
085-001-00	1	Rubber Plug



# Complete Hub & Hub-Drum Kits



## Hub Kit

**K08-287-97**

For 8K idler axle, 8-6.50 BC, studded 1/16"-18, seal, E-Z Lube grease cap, 4.75 pilot diameter.

Dx Part No.	Quantity	Parts Description
006-053-00	8	Nut, Cone 60-deg
006-190-00	1	Nut, Retainer
006-191-00	1	Nut, Hex
008-287-11	1	Hub, 8K, 865, 1/16"-18, Grease, Cupped & Studded
010-036-00	1	Seal, 2.25 ID
021-043-01	1	Grease Cap
031-028-02	1	Bearing Cone (02475)
031-030-02	1	Bearing Cone (25580)
059-831-00	1	Instruction Sheet
085-001-00	1	Rubber Plug



## Hub Kit

**K08-399-90**

For 8K disc brake axle, 8-6.50 BC, studded 1/16"-18, seal, oil cap, 4.75 pilot diameter.

Dx Part No.	Quantity	Parts Description
006-053-00	8	Nut, Cone 60-deg
008-399-06	1	Hub, 8K, 865, Disc Brake, 1/16"-18, Oil, Cupped & Studded
010-036-00	1	Seal, 2.25 ID
010-045-00	1	O-Ring
021-035-01	1	Oil Cap, Black
031-028-02	1	Bearing Cone (02475)
031-030-02	1	Bearing Cone (25580)
046-032-00	1	Rubber Plug
059-831-00	1	Instruction Sheet



## Hub-Drum Kit

**K08-288-90**

For 9K-10K GD axle, 8-6.50 BC, studded 5/8"-18, oil seal, inner bearing, outer bearing, oil cap and wheel clamp ring (prior to 7/27/09).

Dx Part No.	Quantity	Parts Description
006-109-00	8	Nut, Cone 90-deg
008-288-05	1	Hub & Drum, 9K-10K GD, 865, 4.75 Pilot, Cupped & Studded
010-050-00	1	O-Ring
010-051-02	1	Seal, Oil 2.875 ID
021-036-00	1	Oil Cap
031-019-02	1	Bearing Cone (387A)
031-030-02	1	Bearing Cone (25580)
033-052-01	1	Clamp Ring
046-032-00	1	Rubber Plug
059-831-00	1	Instruction Sheet



## Hub Kit

**K08-288-91**

For 9K-10K GD axle, 8-6.50 BC, studed 5/8"-18, oil seal, inner bearing, outer bearing, oil cap and wheel clamp ring (prior to 7/27/09).

Dx Part No.	Quantity	Parts Description
006-109-00	8	Nut, Cone 90-deg
008-288-03	1	Hub, 9K-10K GD, 865, 4.75 Pilot, Cupped & Studed
010-050-00	1	O-Ring
010-051-02	1	Seal, Oil 2.875 ID
021-036-00	1	Oil Cap
031-019-02	1	Bearing Cone (387A)
031-030-02	1	Bearing Cone (25580)
033-052-01	1	Clamp Ring
046-032-00	1	Rubber Plug
059-831-00	1	Instruction Sheet



## Hub Kit

**K08-214-92**

For 10K HD axle, 8-6.50 BC, studed 5/8"-18, oil seal, inner bearing (395S), outer bearing (387A) and oil cap.

Dx Part No.	Quantity	Parts Description
006-109-00	8	Nut, Cone 90-deg
008-214-05	1	Hub, 10K HD, 865, 4.75 Pilot, Cupped & Studed
010-050-00	1	O-Ring
010-056-00	1	Seal, Oil 3.125 ID
021-036-00	1	Oil Cap
031-019-02	1	Bearing Cone (387A)
031-022-02	1	Bearing Cone (395S)
033-052-01	1	Clamp Ring
046-032-00	1	Rubber Plug
059-831-00	1	Instruction Sheet



## Hub Kit

**K08-290-90**

For D200 axle, outboard drum mount (no drum), 10-285.75 BC, studed 22mm, oil seal, grease cap, 8.78" pilot diameter.

Dx Part No.	Quantity	Parts Description
005-098-00	1	Washer, Perf, 25/8" .250
005-099-00	1	Washer, Tang
005-100-00	6	Washer, Lock
006-114-00	1	Nut, Octagon 25/8"-16 Gr 2
006-115-00	1	Nut, Octagon Jam 25/8"-16 Gr 2
006-118-00	10	Nut, Flange
007-157-00	6	Screw, Hex
008-290-13	1	Hub, D200, 10-285.75, 22mm Stud, 8.78 Pilot, Cupped & Studed
010-055-04	1	Seal, Oil 4.625 ID
021-046-00	1	Grease Cap
031-026-02	1	Bearing Cone (HM218248)
031-027-02	1	Bearing Cone (HM212049)
071-124-00	1	Oil Cap Gasket



## Rotor Replacement Kit

**K71-626-00**

For Dexter 3.5K disc brakes, 5-4.50 BC (prior to 7/16).

Dx Part No.	Quantity	Parts Description
059-795-00	1	Instruction Sheet
070-008-01	1	Rotor, 3.5K, 545, E-Coated



## Rotor Replacement Kit

**K71-637-00**

For Dexter 6K disc brakes.

Dx Part No.	Quantity	Parts Description
059-800-00	1	Instruction Sheet
070-009-02	1	Rotor, 6K, 655, E-Coated

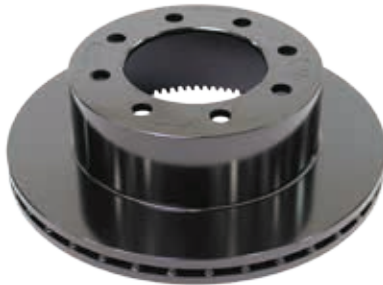

## Rotor Replacement Kit

**K71-631-00**

For Dexter 8K disc brakes.

Dx Part No.	Quantity	Parts Description
059-800-00	1	Instruction Sheet
070-007-02	1	Rotor, 8K, 865, E-Coated



## Bearing Kit

**K71-715-00**

Fits 2K hub inner and outer bearing L44643 / L44643.

Dx Part No.	Quantity	Parts Description
005-101-00	1	Washer, Tang
010-003-00	1	Seal, Grease 1.23 ID
019-002-00	1	Cotter Pin
031-031-01	2	Bearing Cup (L44610)
031-031-03	2	Bearing Cone (L44643)



## Bearing Kit

**K71-716-00**

Fits 2K hub inner and outer bearing L44649 / L44649.

Dx Part No.	Quantity	Parts Description
005-101-00	1	Washer, Tang
010-060-00	1	Seal, Oil 1.5 ID
019-002-00	1	Cotter Pin
031-031-01	2	Bearing Cup (L44610)
031-031-02	2	Bearing Cone (L44649)



## Bearing Kit

**K71-717-00**

Fits 3.5K hub inner and outer bearing L44649 / L68149.

Dx Part No.	Quantity	Parts Description
005-101-00	1	Washer, Tang
010-019-00	1	Seal, Grease 1.72 ID
019-002-00	1	Cotter Pin
031-031-01	1	Bearing Cup (L44610)
031-031-02	1	Bearing Cone (L44649)
031-033-01	1	Bearing Cup (L68111)
031-033-02	1	Bearing Cone (L68149)



## Bearing Kit

**K71-718-00**

Fits 4.4K hub inner and outer bearing LM67048 / L68149.

Dx Part No.	Quantity	Parts Description
010-019-00	1	Seal, Grease 1.72 ID
019-002-00	1	Cotter Pin
031-032-01	1	Bearing Cup (LM67010)
031-032-02	1	Bearing Cone (LM67048)
031-033-01	1	Bearing Cup (L68111)
031-033-02	1	Bearing Cone (L68149)

# Hub Components



## Bearing Kit

**K71-719-00**

Fits 6K hub inner and outer bearing 15123 / 25580.

Dx Part No.	Quantity	Parts Description
005-101-00	1	Washer, Tang
010-036-00	1	Seal, 2.25 ID
019-002-00	1	Cotter Pin
031-029-01	1	Bearing Cup (15245)
031-029-02	1	Bearing Cone (15123)
031-030-01	1	Bearing Cup (25520)
031-030-02	1	Bearing Cone (25580)



## Bearing Kit

**K71-720-00**

Fits 7K hub inner and outer bearing 14125A / 25580.

Dx Part No.	Quantity	Parts Description
005-101-00	1	Washer, Tang
010-036-00	1	Seal, 2.25 ID
019-002-00	1	Cotter Pin
031-017-01	1	Bearing Cup (14276)
031-017-02	1	Bearing Cone (14125A)
031-030-01	1	Bearing Cup (25520)
031-030-02	1	Bearing Cone (25580)



## Bearing Kit

**K71-721-00**

Fits 7.2K and 8K hub inner and outer bearing 02475 / 25580.

Dx Part No.	Quantity	Parts Description
010-036-00	1	Seal, 2.25 ID
019-002-00	1	Cotter Pin
031-028-01	1	Bearing Cup (02420)
031-028-02	1	Bearing Cone (02475)
031-030-01	1	Bearing Cup (25520)
031-030-02	1	Bearing Cone (25580)



## Bearing Kit

**K71-722-00**

Fits 9K and 10K hub inner and outer bearing 387A / 25580.

Dx Part No.	Quantity	Parts Description
010-051-02	1	Seal, Oil 2.875 ID
031-019-01	1	Bearing Cup (382A)
031-019-02	1	Bearing Cone (387A)
031-030-01	1	Bearing Cup (25520)
031-030-02	1	Bearing Cone (25580)



## Bearing Cup & Cone

**K71-306-00**

Fits Dexter 7" hub inner and outer, 10" x 1½" outer and 10" x 2¼" outer, L44610 / L44649.

Dx Part No.	Quantity	Parts Description
031-031-01	1	Bearing Cup (L44610)
031-031-02	1	Bearing Cone (L44649)



## Bearing Cup & Cone

**K71-307-00**

Fits Dexter 10" x 1½" hub inner, 10" x 2¼" outer (4.4K) and 12" x 2" outer, LM67010 / LM67048.

Dx Part No.	Quantity	Parts Description
031-032-01	1	Bearing Cup (LM67010)
031-032-02	1	Bearing Cone (LM67048)



## Bearing Cup & Cone

**K71-390-00**

Fits Dexter 10" x 2¼" hub inner, L68111 / L68149.

Dx Part No.	Quantity	Parts Description
031-033-01	1	Bearing Cup (L68111)
031-033-02	1	Bearing Cone (L68149)



## Bearing Cup & Cone

**K71-308-00**

Fits Dexter 12" x 2" and 12¼" x 2½" hub inner, 25520 / 25580.

Dx Part No.	Quantity	Parts Description
031-030-01	1	Bearing Cup (25520)
031-030-02	1	Bearing Cone (25580)



**Bearing Cup & Cone****K71-310-00**

Fits Dexter 12" x 2" hub 8 bolt outer, 14276 / 14125A.

Dx Part No.	Quantity	Parts Description
031-017-01	1	Bearing Cup (14276)
031-017-02	1	Bearing Cone (14125A)

**Bearing Cup & Cone****K71-415-00**Fits Dexter 12 $\frac{1}{4}$ " x 2 $\frac{1}{2}$ " hub and 12 $\frac{1}{4}$ " x 3 $\frac{3}{8}$ " hub outer, 02420 / 02475.

Dx Part No.	Quantity	Parts Description
031-028-01	1	Bearing Cup (02420)
031-028-02	1	Bearing Cone (02475)

**Bearing Cup & Cone****K71-309-00**

Fits Dexter 8-174 wheel and drum outer, 15245 / 15123.

Dx Part No.	Quantity	Parts Description
031-029-01	1	Bearing Cup (15245)
031-029-02	1	Bearing Cone (15123)

**Bearing Cup & Cone****K71-710-00**

Fits Dexter 10K HD outer and 9K-10K GD inner.

Dx Part No.	Quantity	Parts Description
031-019-01	1	Bearing Cup (382A)
031-019-02	1	Bearing Cone (387A)



## Bearing Cup & Cone

**K71-714-00**

Fits Dexter 10K HD inner and #13D inner, 394A / 395S.

Dx Part No.	Quantity	Parts Description
031-022-01	1	Bearing Cup (394A)
031-022-02	1	Bearing Cone (395S)



## Bearing Cup & Cone

**K71-712-00**

Fits Dexter 12K and 15K inner bearings, 3920 / 3984.

Dx Part No.	Quantity	Parts Description
031-020-01	1	Bearing Cup (3920)
031-020-02	1	Bearing Cone (3984)



## Bearing Cup & Cone

**K71-713-00**

Fits Dexter 12K and 15K outer bearings, 28622 / 28682.

Dx Part No.	Quantity	Parts Description
031-021-01	1	Bearing Cup (28622)
031-021-02	1	Bearing Cone (28682)



### E-Z Lube Grease Cap & Plug Kit

**K71-315-00**

Fits Dexter 7", 10" x 1½" and 10" x 2¼" hub, 1.99 OD, chrome.

Dx Part No.	Quantity	Parts Description
021-041-02	2	Grease Cap
085-001-00	2	Rubber Plug



### E-Z Lube Grease Cap & Plug Kit

**K71-317-00**

Fits Dexter 10" x 2¼" hub, 6 lug (4.4K), 12" x 2" hub, 5 spoke and 6 bolt, 2.45 OD, chrome.

Dx Part No.	Quantity	Parts Description
021-042-02	2	Grease Cap
085-001-00	2	Rubber Plug



### E-Z Lube Grease Cap & Plug Kit

**K71-319-00**

Fits Dexter 12" x 2" hub, 8 bolt, 2.72 OD, chrome.

Dx Part No.	Quantity	Parts Description
021-043-02	2	Grease Cap
085-001-00	2	Rubber Plug



### E-Z Lube Plug

**K71-320-00**

Fits Dexter E-Z Lube grease caps.

Dx Part No.	Quantity	Parts Description
085-001-00	2	Rubber Plug



### Grease Fitting

**K71-292-00**

Fits Dexter E-Z Lube spindles, shackle and hanger bolts.

Dx Part No.	Quantity	Parts Description
061-007-00	2	Grease Fitting

## Hub Components



### Nev-R-Lube Grease Cap Kit

**K71-643-00**

For 42mm Nev-R-Lube hubs.

Dx Part No.	Quantity	Parts Description
021-085-00	2	Grease Cap



### Nev-R-Lube Grease Cap Kit

**K71-642-00**

For 50mm Nev-R-Lube hubs.

Dx Part No.	Quantity	Parts Description
021-086-00	2	Grease Cap



### Grease Cap

**K71-314-00**

Fits Dexter 7", 10" x 1 1/2", 10" x 2 1/4" hub, 1.99 OD.

Dx Part No.	Quantity	Parts Description
021-003-00	2	Grease Cap



### Grease Cap

**K71-316-00**

Fits Dexter 10" x 2 1/4" hub (4.4K), 12" x 2" hub, 5 spoke and 6 bolt, 2.45 OD.

Dx Part No.	Quantity	Parts Description
021-001-00	2	Grease Cap



### Grease Cap

**K71-318-00**

Fits Dexter 12" x 2" hub, 8 bolt, 2.72 OD.

Dx Part No.	Quantity	Parts Description
021-039-00	2	Grease Cap



### Oil Cap, O-Ring & Plug Kit

**K71-038-00**

Fits Dexter 6K and 8K screw-in and Dexter 9K (prior to 10/89) 2 7/8"-12 thread. Replaced 021-029-00 oil cap.

Dx Part No.	Quantity	Parts Description
010-045-00	2	O-Ring
021-035-00	2	Oil Cap
046-032-00	2	Rubber Plug



## Hub Components

**Oil Cap, O-Ring & Plug Kit****K71-148-00**

Fits Dexter 9K (after 10/89) and 10K, 12K, 15K, 4"-12 threads.

Dx Part No.	Quantity	Parts Description
010-050-00	2	O-Ring
021-036-00	2	Oil Cap
046-032-00	2	Rubber Plug

**Oil Cap, O-Ring & Plug Kit****K71-747-00**Fits Dexter 6 bolt and utility hubs, 2<sup>5</sup>/<sub>8</sub>"-12 thread.

Dx Part No.	Quantity	Parts Description
010-059-00	2	O-Ring
021-040-00	2	Oil Cap
046-032-00	2	Rubber Plug

**Oil Cap Replacement Kit****K71-704-00**

Fits Dexter 9K and 10K GD uni-cast hub-drum.

Dx Part No.	Quantity	Parts Description
010-163-00	2	O-Ring
021-088-00	2	Oil Cap
046-032-00	2	Rubber Plug



### Hub Cover

**K71-364-00**

For 5-4.50 wheel, 3.18 OD, chrome.

Dx Part No.	Quantity	Parts Description
016-034-00	1	Hub Cover



### Hub Cover

**K71-312-00**

For 5-4.50 wheel, 3.18 OD, E-Z Lube, chrome.

Dx Part No.	Quantity	Parts Description
016-034-21	1	Hub Cover



### Hub Cover

**K71-404-00**

For 5-4.50 wheel, 3.18 OD, black plastic.

Dx Part No.	Quantity	Parts Description
016-044-00	1	Hub Cover



### Hub Cover

**K71-419-00**

For 5-4.50 wheel, 3.19 OD, E-Z Lube, black plastic.

Dx Part No.	Quantity	Parts Description
016-044-21	1	Hub Cover

# Hub Components



### Hub Cover

**K71-311-00**

For 6-5.50 wheel, 4.27 OD, chrome.

Dx Part No.	Quantity	Parts Description
016-035-00	1	Hub Cover



### Hub Cover

**K71-313-00**

For 6-5.50 wheel, 4.27 OD, E-Z Lube, chrome.

Dx Part No.	Quantity	Parts Description
016-035-21	1	Hub Cover



### Hub Cover

**K71-405-00**

For 6-5.50 wheel, 4.27 OD, black plastic.

Dx Part No.	Quantity	Parts Description
016-045-00	1	Hub Cover



### Hub Cover

**K71-420-00**

For 6-5.50 wheel, 4.27 OD, E-Z Lube, black plastic.

Dx Part No.	Quantity	Parts Description
016-045-21	1	Hub Cover



### Nut Cover

K71-406-00

13/16" hex nut, black plastic, fits Dexter K71-299-00.

Dx Part No.	Quantity	Parts Description
016-046-00	6	Nut Cover

## Hub Components

**Seal****K71-301-00**

Fits Dexter 7" hub, 1.50 ID x 1.987 OD.

Dx Part No.	Quantity	Parts Description
010-060-00	2	Seal, Oil 1.50 ID

**Seal****K71-302-00**

Fits Dexter 10" x 1½" hub, 1.75 ID x 2.33 OD.

Dx Part No.	Quantity	Parts Description
010-042-00	2	Seal, Grease 1.75 ID

**Seal****K71-303-00**

Fits Dexter 10" x 1½" and 10" x 2¼" hub, 1.72 ID x 2.565 OD.

Dx Part No.	Quantity	Parts Description
010-019-00	2	Seal, Grease 1.72 ID

**Seal****K71-304-00**

Fits Dexter 12" x 2" hub, 2.125 ID x 3.376 OD (prior to 1998).

Dx Part No.	Quantity	Parts Description
010-010-00	2	Seal, Oil 2.125 ID



**Seal**

**K71-305-00**

Fits Dexter 12" x 2" hub, 2.250 ID x 3.376 OD (after 1998).

Dx Part No.	Quantity	Parts Description
010-036-00	2	Seal, 2.25 ID



**Seal**

**K71-389-00**

Fits Dexter 12" x 2" MHU hub, 1.938 ID x 2.510 OD.

Dx Part No.	Quantity	Parts Description
010-040-00	2	Seal, Grease 1.938 ID



**Seal**

**K71-386-00**

Fits Dexter 7.2K and 8K hub unitized, 2.250 ID x 3.376 OD.

Dx Part No.	Quantity	Parts Description
010-063-00	2	Seal, 2.25 ID



**Seal**

**K71-387-00**

Fits Dexter 9K and 10K GD hub unitized, 2.875 ID x 3.88 OD.

Dx Part No.	Quantity	Parts Description
010-051-02	2	Seal, Oil 2.875 ID





### Seal

**K71-388-00**

Fits Dexter 10K HD, 15K hubs unitized, 3.125 ID x 4.506 OD.

Dx Part No.	Quantity	Parts Description
010-056-00	2	Seal, Oil 3.125 ID



## Rim Clamps

**K71-298-00**

Fits Dexter 5-spoke demountable 12" x 2" Wheel Drum

Dx Part No.	Quantity	Parts Description
015-002-00	5	Rim Clamp



## Wheel Studs, Thread-In

**K71-407-00**

Replaces 1/2"-20 hub thread, 1/2"-20 nut thread (2.2K).

Dx Part No.	Quantity	Parts Description
025-053-01	4	Stud, Screw-In



## Wheel Studs, Press-In

**K71-295-00**

Replaces 1.84" long wheel stud, 1/2"-20 UNF.

Dx Part No.	Quantity	Parts Description
007-122-00	6	Bolt, Press-In



## Wheel Studs, Press-In

**K71-686-00**

Replaces 2.65" long wheel stud, 1/2"-20 UNF.

Dx Part No.	Quantity	Parts Description
007-262-00	6	Bolt, Press-In



### Wheel Studs, Press-In

**K71-342-00**

Replaces 3.16" long wheel stud, 5/8"-18 UNF.

Dx Part No.	Quantity	Parts Description
007-115-00	4	Bolt, Press-In



### Wheel Studs, Press-In

**K71-748-00**

Replaces 2.30" long wheel stud, 9/16"-18 UNF.

Dx Part No.	Quantity	Parts Description
007-132-00	8	Bolt, Press-In



### Wheel Studs, Press-In

**K71-751-00**

Replaces 9/16"-18 UNF x 2.01 wheel stud.

Dx Part No.	Quantity	Parts Description
007-223-00	8	Bolt, Press-In



### Wheel Studs, Thread-In

**K71-753-00**

Replaces 9/16"-12 x 9/16"-18 x 3.06 wheel stud.

Dx Part No.	Quantity	Parts Description
025-011-00	5	Stud, Screw-In



### Wheel Studs, Press-In

**K71-750-00**

Replaces 5/8"-18 UNF x 2.50 wheel stud.

Dx Part No.	Quantity	Parts Description
007-224-00	8	Bolt, Press-In



### Wheel Studs, Press-In

**K71-749-00**

Replaces 5/8"-18 UNF x 2.75 wheel stud.

Dx Part No.	Quantity	Parts Description
007-232-00	8	Bolt, Press-In



### Wheel Studs, Press-In

**K71-752-00**

Replaces 5/8"-18 UNF x 3.16 wheel stud.

Dx Part No.	Quantity	Parts Description
007-115-00	8	Bolt, Press-In



### Wheel Bolts

**K71-296-00**

Replaces 60-degree, .88 long, 1/2"-20 UNF wheel bolts.

Dx Part No.	Quantity	Parts Description
007-040-00	5	Bolt, 60-degree

# Hub Components



## Wheel Bolts

**K71-297-00**

Fits Dexter MH hub, 1.63 long, 1/2"-13 UNC.

Dx Part No.	Quantity	Parts Description
007-036-00	5	Bolt, Hex



## Wheel Nuts

**K71-299-00**

Replacement for 60-degree cone, 1/2"-20 UNF wheel nuts.

Dx Part No.	Quantity	Parts Description
006-080-00	6	Nut, Cone 60-degree



## Wheel Nuts

**K71-347-00**

Replaces 90-degree cone, 5/8"-18 UNF wheel nut.

Dx Part No.	Quantity	Parts Description
006-109-00	4	Nut, Cone 90-degree



## Rotor Mounting Studs & Nuts Kit

**K71-356-00**

Fits Dexter 10K and 12K disc brakes, 1/2"-13 UNC hub thread, 1/2"-20 UNF nut thread.

Dx Part No.	Quantity	Parts Description
006-046-01	2	Nut, Flange
025-014-00	2	Stud, Screw-In



### Drum Mounting Screws

**K71-355-00**

Fits Dexter 9K and 10K GD, 1.50 long, 1/2"-13 UNC.

Dx Part No.	Quantity	Parts Description
007-292-00	4	Screw, Hex



### Drum Mounting Screws

**K71-354-00**

Fits Dexter 10K HD, 12K and 15K, 1.75 long, 1/2"-13 UNC.

Dx Part No.	Quantity	Parts Description
007-244-00	4	Screw, Hex





### Spindle Nuts & Washers Kit

**K71-367-00**

Fits Dexter 9K (after 10/89) and 10K GD, 1½"-12 UNF, for one end.

Dx Part No.	Quantity	Parts Description
005-070-00	1	Washer, Tongue
005-071-00	1	Washer, Tang
006-096-00	2	Nut, Hex



### Spindle Nuts & Washers Kit

**K71-341-00**

Fits Dexter 10K HD, 12K and 15K, 1¾"-12 UNF, for one end.

Dx Part No.	Quantity	Parts Description
005-059-00	1	Washer, Tang
005-060-00	1	Washer, Tongue
006-084-00	2	Nut, Hex



### Spindle Nuts & Washers Kit

**K71-335-00**

Fits Dexter E-Z Lube axles, 1"-14 UNS (prior to 6/02).

Dx Part No.	Quantity	Parts Description
005-023-00	2	Washer, "D"
005-101-00	2	Washer, Tang
006-001-00	2	Nut, Slotted



### Nuts, Washers & Cotter Kit

**K71-322-00**

Fits Dexter 10" x 1½" and 10" x 2¼" hubs, 1"-14 UNS.

Dx Part No.	Quantity	Parts Description
005-023-00	2	Washer, "D"
006-176-00	2	Nut, Slotted
019-002-00	2	Cotter Pin



## Nuts, Washers & Cotter Kit

K71-321-00

Fits Dexter 12" x 2" and 8K hub, 1"-14 UNS.

Dx Part No.	Quantity	Parts Description
005-057-01	2	Washer, "D"
006-176-00	2	Nut, Slotted
019-002-00	2	Cotter Pin



## Retainer Kit

K71-622-00

Fits Dexter axles (after 6/02).

**Note:** Kit is not to be used on all D20, #8 and #9 axles. It should only be used on axles that have a factory installed "D" washer between the outer bearing and the spindle nut.

Dx Part No.	Quantity	Parts Description
005-023-00	2	Washer, "D"
006-190-00	2	Nut, Retainer
006-191-00	2	Nut, Hex
059-781-00	1	Instruction Sheet



## Suspension Kit

**K71-403-00**

For 1 3/4" wide, double eye springs - single axles (A/P-122-00).

Dx Part No.	Quantity	Parts Description
006-092-01	6	Nut, Flange
007-126-00	2	Bolt, Shoulder
018-012-01	2	Shackle Link
018-021-00	2	Shackle Link Assembly



## Suspension Kit

**K71-401-00**

For 1 3/4" wide, double eye springs - tandem axles with 33" axle spacing (A/P-233-00).

Dx Part No.	Quantity	Parts Description
006-092-01	14	Nut, Flange
007-126-00	6	Bolt, Shoulder
013-104-02	2	Equalizer
018-011-01	4	Shackle Link
018-020-00	4	Shackle Link Assembly



## Suspension Kit

**K71-402-00**

For 1 3/4" wide, double eye springs - triple axles with 33" axle spacing (A/P-335-00).

Dx Part No.	Quantity	Parts Description
006-092-01	22	Nut, Flange
007-126-00	10	Bolt, Shoulder
013-104-02	2	Equalizer
013-105-02	2	Equalizer
018-011-01	6	Shackle Link
018-020-00	6	Shackle Link Assembly



## Heavy Duty Suspension Kit

**K71-358-00**

For 1 3/4" wide, double eye springs - single axles (wet bolts, bronze bushings & heavy duty shackles).

Dx Part No.	Quantity	Parts Description
006-092-01	6	Nut, Flange
007-187-00	2	Bolt, Shoulder
014-077-00	4	Bushing
018-022-01	2	Shackle Link
018-027-01	2	Shackle Link Assembly
059-547-00	1	Instruction Sheet



## Heavy Duty Suspension Kit

**K71-359-00**

For 1 3/4" wide, double eye springs - tandem axles with 33" axle spacing (wet bolts, bronze bushings & heavy duty shackles).

Dx Part No.	Quantity	Parts Description
006-092-01	14	Nut, Flange
007-126-00	2	Bolt, Shoulder
007-187-00	4	Bolt, Shoulder
013-104-04	2	Equalizer
014-077-00	8	Bushing
018-024-01	4	Shackle Link
018-026-00	4	Shackle Link Assembly
059-547-00	1	Instruction Sheet



## Heavy Duty Suspension Kit

**K71-360-00**

For 1 3/4" wide, double eye springs - triple axles with 33" axle spacing (wet bolts, bronze bushings & heavy duty shackles).

Dx Part No.	Quantity	Parts Description
006-092-01	22	Nut, Flange
007-126-00	4	Bolt, Shoulder
007-187-00	6	Bolt, Shoulder
013-104-04	2	Equalizer
013-105-04	2	Equalizer
014-077-00	12	Bushing
018-024-01	6	Shackle Link
018-026-00	6	Shackle Link Assembly
059-547-00	1	Instruction Sheet



## Heavy Duty Suspension Kit

**K71-448-00**

For 1 3/4" wide, double eye springs - tandem axles with 4" high equalizer (wet bolts, bronze bushings & heavy duty shackles).

Dx Part No.	Quantity	Parts Description
006-092-01	14	Nut, Flange
007-126-00	2	Bolt, Shoulder
007-187-00	4	Bolt, Shoulder
013-010-04	2	Equalizer
014-077-00	8	Bushing
018-024-01	4	Shackle Link
018-026-00	4	Shackle Link Assembly
059-547-00	1	Instruction Sheet



## Heavy Duty Suspension Kit

**K71-449-00**

For 1 3/4" wide, double eye springs - tandem axles with 35" axle spacing (wet bolts, bronze bushings & heavy duty shackles).

Dx Part No.	Quantity	Parts Description
006-092-01	14	Nut, Flange
007-126-00	2	Bolt, Shoulder
007-187-00	4	Bolt, Shoulder
013-122-04	2	Equalizer
014-077-00	8	Bushing
018-024-01	4	Shackle Link
018-026-00	4	Shackle Link Assembly
059-547-00	1	Instruction Sheet



## Heavy Duty Suspension Kit

**K71-453-00**

For 1 3/4" wide, 1 3/4" double eye springs - triple axles with 35" axle spacing (wet bolts, bronze bushings & heavy duty shackles).

Dx Part No.	Quantity	Parts Description
006-092-01	22	Nut, Flange
007-126-00	4	Bolt, Shoulder
007-187-00	6	Bolt, Shoulder
013-122-04	2	Equalizer
013-126-04	2	Equalizer
014-077-00	12	Bushing
018-024-01	6	Shackle Link
018-026-00	6	Shackle Link Assembly
059-547-00	1	Instruction Sheet



## E-Z Flex Suspension Kit

**K71-652-00**

6K maximum capacity, tandem 33" axle spacing, 1 3/4" double eye springs, (wet bolts, bronze bushings & heavy duty shackles).

Dx Part No.	Quantity	Parts Description
006-007-01	2	Nut, Hex Locking
006-092-01	12	Nut, Flange
007-003-01	2	Bolt, Press-In
007-187-00	4	Bolt, Shoulder
013-143-03	2	Equalizer Assembly
014-077-00	8	Bushing
018-024-01	4	Shackle Link
018-026-00	4	Shackle Link Assembly
059-867-00	1	Instruction Sheet



## E-Z Flex Suspension Kit

**K71-656-00**

6K maximum, triple 33" axle spacing, 1 3/4" double eye springs, (wet bolts, bronze bushings & heavy duty shackles).

Dx Part No.	Quantity	Parts Description
006-007-01	4	Nut, Hex Locking
006-092-01	18	Nut, Flange
007-003-01	4	Bolt, Press-In
007-187-00	6	Bolt, Shoulder
013-143-03	2	Equalizer Assembly
013-145-03	2	Equalizer Assembly
014-077-00	12	Bushing
018-024-01	6	Shackle Link
018-026-00	6	Shackle Link Assembly
059-867-00	1	Instruction Sheet



## E-Z Flex Equalizer & Bolts

**K71-658-00**

6K maximum capacity, triple 33" axle spacing, 1 3/4" double eye springs.

Dx Part No.	Quantity	Parts Description
006-007-01	4	Nut, Hex Locking
007-003-01	4	Bolt, Press-In
013-143-03	2	Equalizer Assembly
013-145-03	2	Equalizer Assembly
059-863-00	1	Instruction Sheet



# Suspension Components



## E-Z Flex Equalizer & Bolts

**K71-654-00**

6K maximum capacity, tandem 33" axle spacing, 1 $\frac{3}{4}$ " double eye springs (wet bolts, bronze bushings & heavy duty shackles).

Dx Part No.	Quantity	Parts Description
006-007-01	2	Nut, Hex Locking
007-003-01	2	Bolt, Press-In
013-143-03	2	Equalizer Assembly
059-863-00	1	Instruction Sheet



## E-Z Flex Suspension Kit

**K71-653-00**

8K maximum capacity, tandem 35" axle spacing, 1 $\frac{3}{4}$ " double eye springs (wet bolts, bronze bushings & heavy duty shackles).

Dx Part No.	Quantity	Parts Description
006-007-01	2	Nut, Hex Locking
006-092-01	12	Nut, Flange
007-003-01	2	Bolt, Press-In
007-187-00	4	Bolt, Shoulder
013-144-03	2	Equalizer Assembly
014-077-00	8	Bushing
018-024-01	4	Shackle Link
018-026-00	4	Shackle Link Assembly
059-867-00	1	Instruction Sheet



## E-Z Flex Suspension Kit

**K71-657-00**

8K maximum capacity, triple 35" axle spacing, 1 $\frac{3}{4}$ " double eye springs (wet bolts, bronze bushings & heavy duty shackles).

Dx Part No.	Quantity	Parts Description
006-007-01	4	Nut, Hex Locking
006-092-01	18	Nut, Flange
007-003-01	4	Bolt, Press-In
007-187-00	6	Bolt, Shoulder
013-144-03	2	Equalizer Assembly
013-146-03	2	Equalizer Assembly
014-077-00	12	Bushing
018-024-01	6	Shackle Link
018-026-00	6	Shackle Link Assembly
059-867-00	1	Instruction Sheet



## E-Z Flex Equalizer & Bolts

**K71-655-00**

8K maximum capacity, tandem 35" axle spacing, 1 $\frac{3}{4}$ " double eye springs.

Dx Part No.	Quantity	Parts Description
006-007-01	2	Nut, Hex Locking
007-003-01	2	Bolt, Press-In
013-144-03	2	Equalizer Assembly
059-863-00	1	Instruction Sheet



## E-Z Flex Equalizer & Bolts

**K71-659-00**

8K maximum capacity, triple 35" axle spacing, 1<sup>3</sup>/<sub>4</sub>" double eye springs.

Dx Part No.	Quantity	Parts Description
006-007-01	4	Nut, Hex Locking
007-003-01	4	Bolt, Press-In
013-144-03	2	Equalizer Assembly
013-146-03	2	Equalizer Assembly
059-863-00	1	Instruction Sheet



## Tandem Attaching Parts Kit

**K71-660-00**

E-Z Flex suspension kit, tandem 33" axle spacing, 1<sup>3</sup>/<sub>4</sub>" double eye springs (heavy duty shackles).

Dx Part No.	Quantity	Parts Description
006-007-01	2	Nut, Hex Locking
006-092-01	12	Nut, Flange
007-003-01	2	Bolt, Press-In
007-126-00	4	Bolt, Shoulder
013-143-03	2	Equalizer Assembly
018-024-01	4	Shackle Link
018-028-00	4	Shackle Link
059-863-00	1	Instruction Sheet



## Removable Spindle Kit

**K71-742-00**

Fits Dexter Torflex #9 removable spindle system.

Dx Part No.	Quantity	Parts Description
002-287-22	1	Spindle #9
005-023-00	1	Washer, "D"
005-162-00	1	Washer, Loc
006-190-00	1	Nut, Retainer
006-191-00	1	Nut, Hex
007-288-00	1	Screw, Hex
059-897-00	1	Instruction Sheet
088-008-00	1	Grease Packet



## Removable Spindle Kit

**K71-743-00**

Fits Dexter Torflex #10 removable spindle system.

Dx Part No.	Quantity	Parts Description
002-286-22	1	Spindle #10
005-023-00	1	Washer, "D"
005-162-00	1	Washer, Loc
006-190-00	1	Nut, Retainer
006-191-00	1	Nut, Hex
007-288-00	1	Screw, Hex
059-897-00	1	Instruction Sheet
088-008-00	1	Grease Packet



## Removable Spindle Kit

**K71-744-00**

Fits Dexter Torflex #11 removable spindle system.

Dx Part No.	Quantity	Parts Description
002-285-22	1	Spindle #11
005-023-00	1	Washer, "D"
005-162-00	1	Washer, Loc
006-190-00	1	Nut, Retainer
006-191-00	1	Nut, Hex
007-289-00	1	Screw, Hex
059-897-00	1	Instruction Sheet
088-008-00	1	Grease Packet



## Removable Spindle Kit

**K71-745-00**

Fits Dexter Torflex #12 removable spindle system.

Dx Part No.	Quantity	Parts Description
002-284-22	1	Spindle #12
005-057-00	1	Washer, "D"
005-162-00	1	Washer, Loc
006-190-00	1	Nut, Retainer
006-191-00	1	Nut, Hex
007-289-00	1	Screw, Hex
059-897-00	1	Instruction Sheet
088-008-00	1	Grease Packet



## Over/Under Conversion Kit

**K71-384-00**

Conversion kit for 2<sup>3</sup>/<sub>8</sub>" tube.

Dx Part No.	Quantity	Parts Description
003-064-00	2	Spring Seat Weldment 2.38 OD
006-017-01	8	Nut, Hex
006-094-00	4	Nut Coupling 1/2-13 Gr 2
011-074-01	4	U-Bolt
012-051-02	2	Tie Plate
059-551-00	1	Instruction Sheet



## Over/Under Conversion Kit

**K71-385-00**

Conversion kit for 3" tube.

Dx Part No.	Quantity	Parts Description
003-070-00	2	Spring Seat Weldment 3.00 OD
006-094-00	4	Nut Coupling 1/2-13 Gr 2
006-129-01	8	Nut, Hex
011-017-01	4	U-Bolt
012-001-02	2	Tie Plate
059-551-00	1	Instruction Sheet



## Shock Kit

**K71-175-01**

Fits 2<sup>3</sup>/<sub>4</sub>" and 3" tube for 1.75" wide springs; for one axle.

Dx Part No.	Quantity	Parts Description
005-115-00	4	Washer, Plain
005-116-00	4	Washer, Plain
012-055-01	2	Tie Plate
033-029-00	2	Bracket, Upper Shock
052-003-00	2	Shock Absorber and Attaching Hardware
059-258-00	1	Instruction Sheet



## Shock Kit

**K71-697-00**

Replacement shock kit; single axle.

Dx Part No.	Quantity	Parts Description
052-003-00	2	Shock Absorber and Attaching Hardware

# Suspension Components



## U-Bolts & Nuts Kit

**K71-391-00**

Replacement for 1.75" axle tube; 3/8"-24 UNF.

Dx Part No.	Quantity	Parts Description
006-130-01	4	Nut, Flange
011-054-01	2	U-Bolt



## U-Bolts & Nuts Kit

**K71-293-00**

Replacement for 2.38" axle tube; 7/16"-20 UNF.

Dx Part No.	Quantity	Parts Description
006-017-01	4	Nut, Hex
011-074-01	2	U-Bolt



## U-Bolts & Nuts Kit

**K71-294-00**

Replacement for 3.00" axle tube; 1/2"-20 UNF.

Dx Part No.	Quantity	Parts Description
006-129-01	4	Nut, Hex
011-017-01	2	U-Bolt



## U-Bolts & Nuts Kit

**K71-730-00**

Fits 1.75" diameter axle tube; 3/8"-24 thread. (Torque from 30 to 50 ft. lbs.)

Dx Part No.	Quantity	Parts Description
006-130-01	8	Nut, Flange
011-054-01	4	U-Bolt
012-040-01	2	Tie Plate



## U-Bolts & Nuts Kit

**K71-731-00**

Fits 2.38" diameter axle tube; 7/16"-20 thread. (Torque from 45 to 70 ft. lbs.)

Dx Part No.	Quantity	Parts Description
006-017-01	8	Nut, Hex
011-075-01	4	U-Bolt
012-051-02	2	Tie Plate



## U-Bolts & Nuts Kit

**K71-732-00**

Fits 3" diameter axle tube; 1/2"-20 thread. (Torque from 45 to 70 ft. lbs.)

Dx Part No.	Quantity	Parts Description
006-129-01	8	Nut, Hex
011-018-01	4	U-Bolt
012-001-02	2	Tie Plate



## Shackle Link

**K71-288-00**

2.25" hole to hole, 3.50" long. Use with shackle bolt kit K71-290-00.

Dx Part No.	Quantity	Parts Description
018-011-01	4	Shackle Link



## Shackle Link

**K71-289-00**

3.12" hole to hole, 4.38" long. Use with shackle bolt kit K71-290-00.

Dx Part No.	Quantity	Parts Description
018-012-01	4	Shackle Link



# Suspension Components



## Shackle Bolt & Flange Nut Kit

**K71-290-00**

2.90" long, 7/16"-20 UNF.

Dx Part No.	Quantity	Parts Description
006-092-01	2	Nut, Flange
007-126-01	2	Bolt, Shoulder



## Wet Shackle Bolt & Flange Nut

**K71-696-00**

Replaces 9/16"-2.90" long shackle bolt, 7/16"-20.

Dx Part No.	Quantity	Parts Description
006-092-01	4	Nut, Flange
007-187-00	4	Bolt, Shoulder



## Rubber Equalizer Bushing

**K71-371-00**

Fits Dexter 8K-9K axles.

Dx Part No.	Quantity	Parts Description
014-074-00	1	Bushing



## Rubber Spring Eye Bushing

**K71-370-00**

Fits Dexter 10K-15K axles.

Dx Part No.	Quantity	Parts Description
014-069-00	1	Bushing



## Rubber Equalizer Bushing

**K71-372-00**

Fits Dexter 10K-15K axles.

Dx Part No.	Quantity	Parts Description
014-070-00	1	Bushing



## Slipper Spring Kit

**K71-365-00**

For 2800-6000 lb. axles with 33.5" axle spacing (A/P-202-00).

Dx Part No.	Quantity	Parts Description
006-007-01	4	Nut, Hex Locking
006-011-00	4	Nut, Hex Locking
006-111-00	2	Nut, Hex Locking
007-001-01	2	Bolt, Carriage
007-007-00	4	Bolt, Hex
007-017-00	4	Bolt, Hex
013-004-00	2	Equalizer



## Slipper Spring Kit

**K71-366-00**

For 7K and 8K axles with 36" axle spacing (A/P-216-00).

Dx Part No.	Quantity	Parts Description
006-007-01	4	Nut, Hex Locking
006-011-00	4	Nut, Hex Locking
006-111-00	2	Nut, Hex Locking
007-001-01	2	Bolt, Carriage
007-007-00	4	Bolt, Hex
007-017-00	4	Bolt, Hex
013-044-01	2	Equalizer



## Bronze Bushing Kit

**K71-291-00**

For spring eye and equalizer. 1.74" long, .575" ID, .698" OD.

Dx Part No.	Quantity	Parts Description
014-077-00	4	Bushing

# Suspension Components



## Grease Fitting

**K71-292-00**

Fits Dexter E-Z Lube spindles, shackle and hanger bolts.

Dx Part No.	Quantity	Parts Description
061-007-00	2	Grease Fitting



## Frame Spacer Kit

**K71-723-01**

Fits Dexter Torflex #9 axles. Increases ride by 2.63", for one axle. Cannot be used with Torflex axles produced with 3" high profile brackets.

Dx Part No.	Quantity	Parts Description
003-399-02	2	Frame Spacer #9
005-080-00	12	Washer, Plain
006-125-00	8	Nut, Hex Locking
007-153-00	8	Bolt, Hex
059-886-00	1	Instruction Sheet



## Frame Spacer Kit

**K71-707-01**

Fits Dexter Torflex #10 axles. Increases ride by 2.63", for one axle. Cannot be used with Torflex axles produced with 3" high profile brackets.

Dx Part No.	Quantity	Parts Description
003-377-02	2	Frame Spacer #10
005-111-00	12	Washer, Plain
006-126-00	8	Nut, Hex Locking
007-177-00	8	Screw, Hex
059-886-00	1	Instruction Sheet



## Frame Spacer Kit

**K71-707-02**

Fits Dexter Torflex #10 axles. Increases ride by 2.63", for two axles. Cannot be used with Torflex axles produced with 3" high profile brackets.

Dx Part No.	Quantity	Parts Description
003-377-02	4	Frame Spacer #10
005-111-00	24	Washer, Plain
006-126-00	16	Nut, Hex Locking
007-177-00	16	Screw, Hex
059-886-00	1	Instruction Sheet



## Frame Spacer Kit

**K71-724-02**

Fits Dexter Torflex #11 axles. Increases ride height by 2.88", for two axles.

Dx Part No.	Quantity	Parts Description
003-400-02	4	Frame Spacer #11
005-111-00	24	Washer, Plain
006-126-00	16	Nut, Hex Locking
007-177-00	16	Screw, Hex
059-886-00	1	Instruction Sheet



## Frame Spacer Kit

**K71-725-02**

Fits Dexter Torflex #12 axles. Increases ride height by 3.13", for two axles.

Dx Part No.	Quantity	Parts Description
003-401-02	4	Frame Spacer #12
005-111-00	24	Washer, Plain
006-126-00	16	Nut, Hex Locking
007-177-00	16	Screw, Hex
059-886-00	1	Instruction Sheet



## Pivot Bushing Replacement Kit

**K71-734-00**

Front pivot bushing replacement kit for one Airflex axle.

Dx Part No.	Quantity	Parts Description
006-287-00	2	Nut, Hex Locking
007-466-00	2	Bolt, Hex
014-123-00	2	Pivot Bushing Assembly
014-127-00	2	Pivot Bushing Spacer
059-899-00	1	Instruction Sheet

# Suspension Components



## Airflex Air Control Ride Height Kit

**K71-692-01**

Fits Dexter Airflex products.  
(Components available in kit form only - individual items not available).

Dx Part No.	Quantity	Parts Description
n/a	1	Ride Height Control Valve
n/a	1	Link Assembly
n/a	2	Valve Attaching Bolt 1/4"-20 UNC x 1.00
n/a	2	Valve Attaching Nut 1/4"-20 UNC Nylock
n/a	1	Link Attaching Bolt 1/4"-20 UNC x 2.00



## Airflex Air Control Kit

**K71-692-02**

Fits Dexter Airflex products. Includes air supply.  
(Components available in kit form only - individual items not available).

Dx Part No.	Quantity	Parts Description
n/a	1	Enclosure, Stainless Steel
n/a	1	Air Compressor
n/a	1	Tank
n/a	1	Reservoir
n/a	1	Drain Valve
n/a	1	Pressure Switch
n/a	1	Dump Valve
n/a	1	Pressure Gage
n/a	1	Fittings
n/a	1	Hose



## Airflex Air Control Kit

**K71-692-03**

Fits Dexter Airflex products. No air supply included.  
(Components available in kit form only - individual items not available).

Dx Part No.	Quantity	Parts Description
n/a	1	Enclosure
n/a	1	Dump Valve
n/a	1	Pressure Gage
n/a	1	Fittings
n/a	1	Hose



## What Products Are Covered

All Dexter Axle Company (“Dexter”) trailer axles, suspensions, and brake control systems manufactured on or after September 1, 2016, excluding Dexter 6000 series Manufactured Housing Axles. Additional exclusions include the following brands: UFP by Dexter, AL-KO (IAC), Titan Brakes and Actuators by Dexter, and BrakeRite by Dexter products, which are covered under separate warranties.

## Limited 1 Year Warranty

As specified in Dexter’s current publication “Operation Maintenance Service Manual”, grease and oil seals FOR ALL PRODUCTS have a one (1) year limited warranty to the original purchaser from the date of first sale of the trailer incorporating such components. **Except as to grease and oil seals, the following four other warranties are available.**

## Limited 2 Year Warranty

Dexter warrants to the original purchaser that its electric/hydraulic brake actuators shall be free from defects in material and workmanship for a period of two (2) years from the date of first sale of the trailer incorporating such components.

## Limited 5 Year Warranty

Dexter warrants to the original purchaser that its axles, suspension systems and Genuine Replacement Parts shall be free from defects in material and workmanship for a period of five (5) years. The warranty period shall begin from the date of the original purchase of the trailer and/or Genuine Replacement Parts.

## Limited 7 Year Warranty

Dexter warrants to the original purchaser that its Predator Series® electric brake controllers shall be free from defects in material and workmanship for a period of seven (7) years from the date of purchase.

## Limited 10 Year Warranty

Dexter warrants to the original purchaser that the suspension components of its Torflex® axles shall be free from defects in material and workmanship for a period of ten (10) years from the date of first sale of the trailer incorporating such suspension components.

## Exclusive Remedy

Dexter will, at its option, repair or replace the affected components of any defective axle, repair or replace the entire defective axle, or refund the lesser of the original purchase price and the then-current list price of the axle or components. In all cases, a reasonable time period must be allowed for warranty repairs to be completed. Allowance will only be made for installation costs specifically approved by Dexter.

## What You Must Do

In order to make a claim under these warranties:

1. You must be the original purchaser of the trailer in which the sprung suspension axles or Torflex® axles or components were originally installed.
2. You must promptly notify Dexter after detection of any defect, but in any case within the applicable warranty period of such defect, and provide us with the axle or applicable component serial number and any substantiation of such defect which may include, but is not limited to, the return of part(s) that we may reasonable request.
3. The axles, suspensions and components must have been installed and maintained in accordance with good industry practice and any specific Dexter recommendations, including those specified in Dexter’s current publication “Operation Maintenance Service Manual”.

## Exclusions

These warranties do not extend to and do not cover defects caused by:

1. The connecting of brake wiring to the trailer wiring or trailer wiring to the towing vehicle wiring.
2. The attachment of the running gear to the frame.
3. Parts not supplied by Dexter.
4. Any damage whatsoever caused by or related to any alteration of the axle including welding supplemental brackets to the axle.
5. Use of an axle on a unit other than the unit to which it was originally mounted.
6. Normal wear and tear.
7. Improper alignment.
8. Improper installation.
9. Unreasonable use (including failure to provide reasonable and necessary maintenance as specified in Dexter’s current publication “Operation Maintenance Service Manual including required maintenance after “Prolonged Storage”.
10. Improper torque values and torquing of wheel nuts. (The proper torquing procedure and torque values are contained in Dexter’s current publication “Operation Maintenance Service Manual”).
11. Cosmetic finish or corrosion.

## Limitations

1. **In all cases, Dexter reserves the right to fully satisfy its obligations under the Limited Warranties by refunding the lesser of the original purchase price and the then-current list price of the defective axle (or, if the axle has been discontinued, of the most nearly comparable current product).**
2. Dexter reserves the right to furnish a substitute of replacement component or product in the event an axle or any component of the axle is discontinued or is otherwise unavailable.
3. These warranties are nontransferable.

## General

**THE FOREGOING WARRANTIES ARE EXCLUSIVE AND IN LIEU OF ALL OTHER WARRANTIES EXCEPT THAT OF TITLE, WHETHER WRITTEN, ORAL OR IMPLIED, IN FACT OR IN LAW (INCLUDING ANY WARRANTY AGAINST INFRINGEMENT OR OF MERCHANTABILITY OR FITNESS FOR A PARTICULAR PURPOSE).**

These warranties give you specific legal rights, and you may also have other rights which vary from state to state.

**DEXTER HEREBY EXCLUDES INCIDENTAL AND CONSEQUENTIAL DAMAGES, INCLUDING LOSS OF TIME, INCONVENIENCE, LOSS OF USE, TOWING FEES, TELEPHONE CALLS, COST OF MEALS OR LODGING, FOR ANY BREACH OF ANY EXPRESS OR IMPLIED WARRANTY.**

Some states do not allow limitations on how long an implied warranty lasts, or the exclusion or limitation if incidental or consequential damages, so the above exclusion or limitation may not apply to you.

Inquiries regarding these warranties should be sent to:

Dexter Axle Company  
P.O. Box 250  
Elkhart, IN 46515

**Note:** Current publication “Operation Maintenance Service Manual” can be found at [www.dexteraxle.com](http://www.dexteraxle.com).





In keeping with our continual commitment to industry safety and the development of innovative products, please feel free to view our ongoing video gallery at “[www.dexteraxle.com/video\\_gallery](http://www.dexteraxle.com/video_gallery)” or scan the following QR codes with your smart phone. We are confident these videos will help educate and promote the Dexter product line that you, as our customer, are investing in.



Bearing Maintenance



E/H Actuator Installation



E-Z Flex® Suspension



E-Z Lube® System



Genuine Brakes



Genuine Replacement Parts



Leaf Spring Axles



Manual Brake Bleeding



Medium Duty Axles



Nev-R-Adjust® Brakes



Power Brake Bleeding



Removable Spindle



Sway Control



Torflex® Suspension Axles

**Genuine Dexter axles and components are available nationwide from our plant locations listed below or through our network of distributors. Check our web site for the distributor nearest you.**

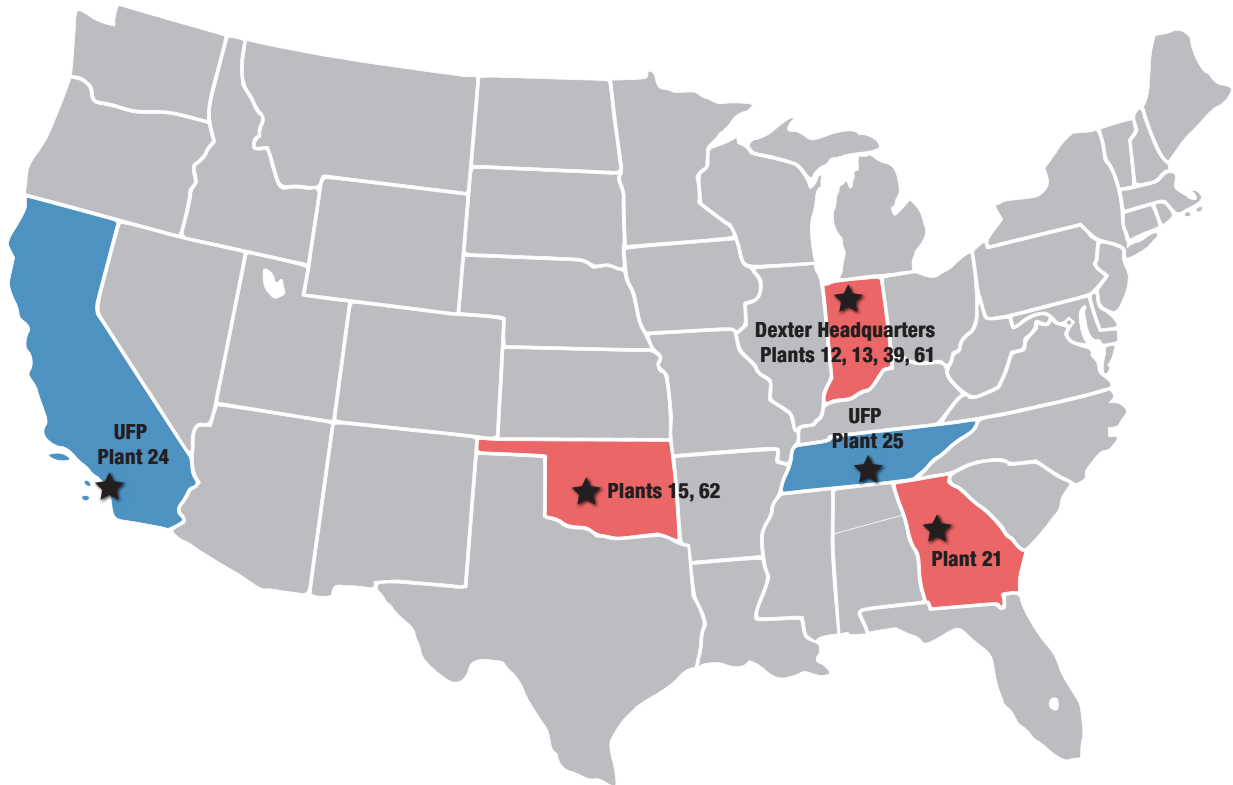

## **Dexter - Headquarters**

2900 Industrial Parkway East ■ Elkhart, Indiana 46516

Phone: 574-295-7888 ■ Fax: 574-295-8666

[www.dexteraxle.com](http://www.dexteraxle.com)

### **Dexter - Plt 12**

301 West Pearl Street  
Fremont, Indiana 46737  
Phone: 260-495-5100  
Fax: 260-495-1701

### **Dexter - Plt 13**

500 South 7th Street  
Albion, Indiana 46701  
Phone: 260-636-2195  
Fax: 260-636-3030

### **Dexter - Plt 15**

500 Southeast 27th Street  
El Reno, Oklahoma 73036  
Phone: 405-262-6700  
Fax: 405-262-9089

### **Dexter - Plt 21**

199 Perimeter Road  
Monticello, Georgia 31064  
Phone: 706-468-6495  
Fax: 706-468-2966

### **Ventline - Plt 39**

902 South Division Street  
Bristol, Indiana 46507  
Phone: 574-848-4491  
Fax: 574-848-4825  
[www.ventline.com](http://www.ventline.com)

### **Dexter Door - Plt 39**

902 South Division Street  
Bristol, Indiana 46507  
Phone: 574-848-4491  
Fax: 574-848-4825  
[www.dexterdoor.com](http://www.dexterdoor.com)

### **Dexter - Plt 61**

21611 Protecta Drive  
Elkhart, Indiana 46516  
Phone: 574-294-6651  
Fax: 574-295-6626

### **Dexter - Plt 62**

301 North Kennedy Street  
Shawnee, Oklahoma 74801  
Phone: 405-273-9315  
Fax: 405-273-1054

### **UFP - Plt 24**

135 Sunshine Lane  
San Marcos, California 92069  
Phone: 760-744-1610  
Fax: 760-744-1616

### **UFP/BrakeRite - Plt 25**

1041 Baxter Lane  
Winchester, Tennessee 37398  
Phone: 931-967-5101  
Fax: 931-967-1828

---

**NO PART OF THIS CATALOG MAY BE REPRODUCED WITHOUT DEXTER'S PERMISSION.  
ALL PART NUMBERS, DIMENSIONS AND SPECIFICATIONS IN THIS CATALOG ARE SUBJECT  
TO CHANGE WITHOUT NOTICE.**

---



[www.dexteraxle.com](http://www.dexteraxle.com)

2900 Industrial Parkway East ■ Elkhart, IN 46516  
Phone: 574-295-7888 ■ Fax: 574-295-8666

**ISO 9001 Certified**

