

March 29, 2016

03583 Version 1

2012 Civic Front Passenger's Airbag Inflator Collection

AFFECTED VEHICLES

Year	Model	Trim	VIN Range
2012	Civic	ALL	Customer Appointment

BACKGROUND

American Honda is conducting a study of front passenger's airbag inflators. This collection involves a small number of front passenger airbag inflators from specific locations. Once customers are located, an appointment will be set up at a local dealership to collect the parts.

To help American Honda collect the front passenger airbag inflators for the study, **submit claims and return the parts as soon as possible.**

The box used in this collection will have a pink sticker on it to distinguish it from other airbag or inflator parts. Do not include these collected parts as part of your pallet shipment. Instead, follow the shipping instructions included in the box.

PINK LABEL

After this study is complete, the bulletin will be discontinued.

COLLECTION ACTION

Replace the front passenger's airbag inflator, then return the original, undeployed front passenger's airbag inflator as directed.

Do not include the inflator from this service bulletin in the pallet shipments. Make sure these parts are returned as quickly as possible using FedEx.

CUSTOMER INFORMATION: The information in this bulletin is intended for use only by skilled technicians who have the proper tools, equipment, and training to correctly and safely maintain your vehicle. These procedures should not be attempted by "do-it-yourselfers," and you should not assume this bulletin applies to your vehicle, or that your vehicle has the condition described. To determine whether this information applies, contact an authorized Honda automobile dealer.

PARTS INFORMATION

Part Name	Part Number	Quantity
Front Passenger's Airbag Inflator Kit (includes inflator, four 5 mm lock nuts, three 6 mm nuts, harness, and A-pillar one-time use clip)	04785-TR3-305	1

NOTE:

- The original box must be used to return the front passenger's inflator to its supplier, ideally within 48 hours of the repair. Be careful not to damage the inflator kit box.
- If the undeployed inflator is not returned, the warranty claim for that vehicle will be charged back to your dealership.
- **Do not include these inflators as part of your pallet shipment.** Follow the shipping instructions supplied with the inflator kit. If you have any questions about shipping, call Warranty Parts Inspection (WPI) at **937-642-2737**.

WARRANTY CLAIM INFORMATION

NOTE:

- Process claims as quickly as possible so that resources can be properly allocated.
- Enter the part number of the inflator that you received into the warranty claim.
- To avoid non-payment of warranty claims, the serial number on the box of the new inflator must be entered in the **serial number field** on each warranty claim. For more information, refer to step 1 of REPAIR PROCEDURE.
- To avoid non-payment of warranty claims, the serial number on the box of the new inflator must be entered in the **replacement serial number field** on each warranty claim. For more information, refer to step 1 of REPAIR PROCEDURE.
- The serial number is encoded into a barcode attached to the outside of the box. If your dealership uses a scanner, you can scan the part number into the claim.
- If you confuse the serial number and part number when entering the claim information, your claim will automatically be rejected.
- For more information about scanning and filling airbag inflator recall claims, refer to Ordering and Managing Replacement Inflators. From the iN, select **SERVICE, WARRANTY**, then **CLAIMS REFERENCE GUIDE**. Under **HOT TIPS/TOPICS**, select **Ordering and Managing Replacement Inflators**.
- To avoid a warranty claim being charged back to your dealership, you must return the undeployed inflator to its supplier. Follow the shipping instructions supplied with the inflator kit. If you have any questions about shipping, call Warranty Parts Inspection (WPI) at **937-642-2737**.

Operation Number	Description	Flat Rate Time	Defect Code	Symptom Code	Template ID	Failed Part Number
7541B7	Parts collection: Front passenger's airbag inflator	0.7 hr	5KT00	JY700	16-032A	77820-TR0-A81ZA

Skill Level: Repair Technician

REPAIR PROCEDURE

NOTE:

- **If the VIN status inquiry indicates that the vehicle is subject to any open safety recalls or product updates, make sure to also complete those recall repairs before returning the vehicle to the customer. If you are unable to complete any open recall, advise the customer of the recall status and when the recall could be completed.**
- Be careful not to damage any parts when replacing the passenger's airbag inflator and follow the procedure exactly.
- If, before removing the airbag, you suspect that it may be the incorrect airbag for the vehicle or a counterfeit, **do not remove the airbag**. Contact your DPSM for assistance.
- Make sure you have reviewed the SRS Precautions and Procedures in the service information before doing the repair procedure.
- Make sure you use all the new hardware included in the kit. Do not reuse must replace parts.

Before removing the front passenger's inflator

1. Turn the ignition to ON and check if the SRS indicator comes on for about 6 seconds, then turns off.
 - If the indicator comes on, then goes off after about 6 seconds, go to step 2.
 - If the indicator does not come on, or if it stays on, contact your DPSM for assistance.
2. Disconnect the battery negative cable and wait at least 3 minutes before continuing.

Replace the front passenger's airbag inflator

NOTE:

- **Make sure you follow the instructions to make sure the harness is properly connected.**
 - Put on gloves to protect your hands.
 - Use the appropriate tool from the KTC trim tool set to avoid damage when removing components.
 - Take care not to scratch the dashboard or the related parts.
 - When prying with a flat-tip screwdriver, wrap it with protective tape to prevent damage.
1. Remove the front passenger's airbag. Refer to service information.

NOTE: You will have to break the one-time use clip in the A-pillar trim.

2. Place the airbag, face-down, on a clean shop towel.

NOTE: The orientation of the airbag is critical because if the inflator is installed incorrectly, the harness will be too short when you reinstall the airbag.

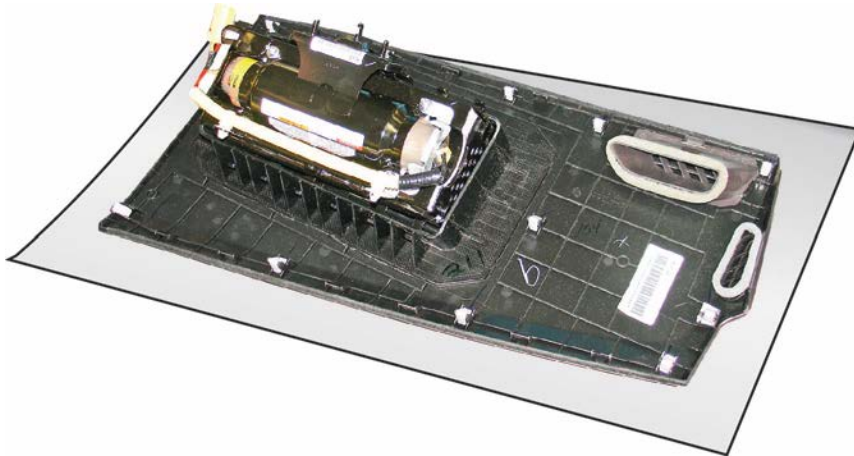

3. Visually inspect the airbag and the inflator for any unusual writing or markings.

- If there is nothing unusual about the airbag or the inflator, go to step 4.
- If there are any unusual markings, like an incorrect label or a model year written in marker, the airbag and inflator may not be the correct airbag and/or inflator for the vehicle or it may be a counterfeit part. For more information about counterfeit airbags, you can refer to safercar.gov, enter keywords **MANAGING COUNTERFEIT**, and select **Recommended Dealer Guidance for Managing Counterfeit Air Bags** from the list. **If you suspect that the airbag or inflator is counterfeit, do not continue this procedure.** Contact your DPSM for assistance.

NON-STANDARD SAFETY LABEL

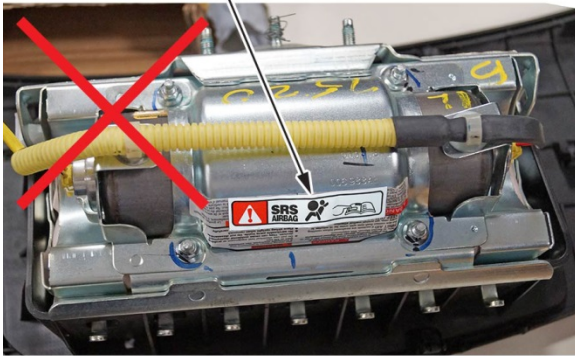

GREASE PENCIL OR PAINT MARKINGS

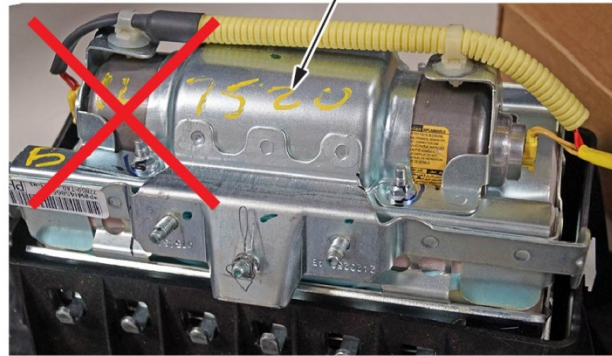

HAND ENGRAVING



NO LABELS ON INFLATOR

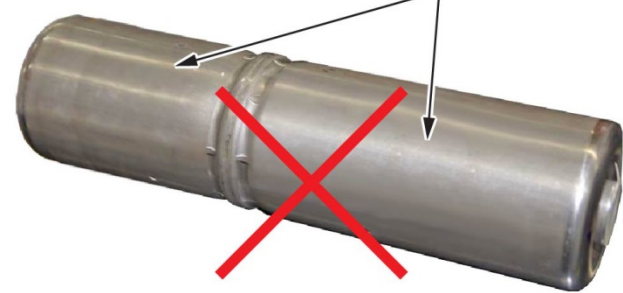

4. Remove the harness from both ends of the inflator brackets.

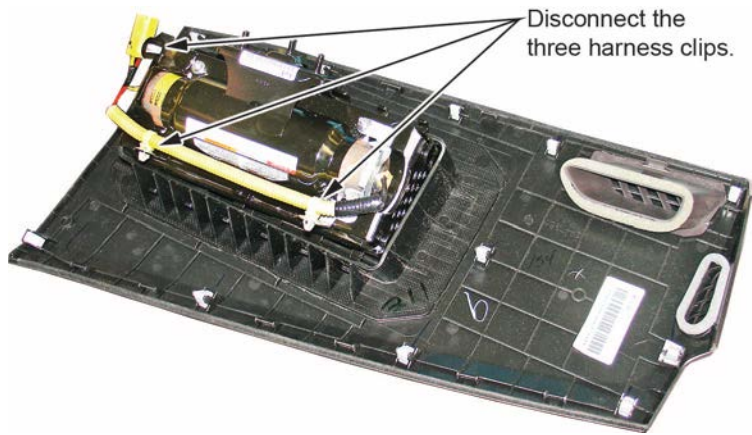

5. Short the yellow wires.

NOTE: You must cut and short the yellow wires as indicated to prevent accidental deployment. Leave the red wires uncut as the connector shorts those wires.

- Cut the rubber tubing so that you have about 2 inches of the yellow wires exposed.

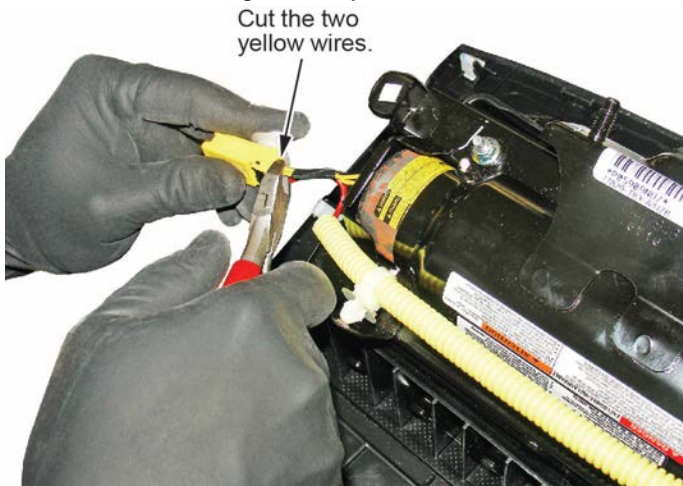

- Cut the yellow wires as shown.

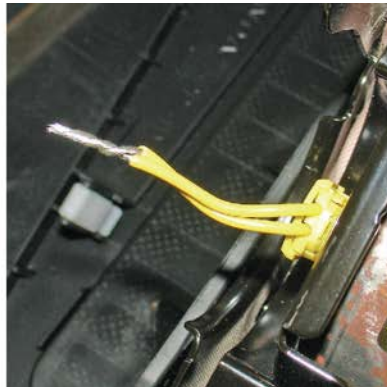
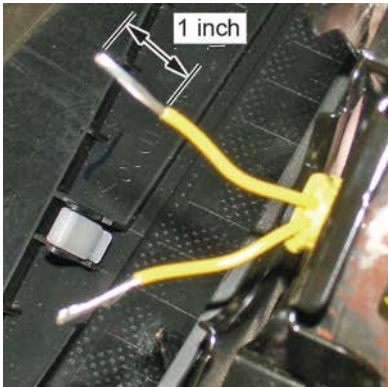

- Strip away about 1 inch of the wire insulation, then twist the wires together.
- Tape the twisted ends with electrical tape.

6. Remove the four inflator locknuts.

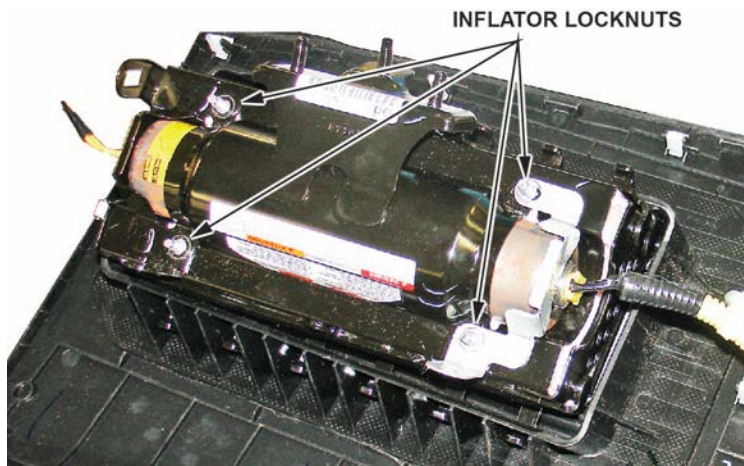

7. Remove the inflator bracket.

NOTE: You can only remove one of the brackets, as the other is welded to the airbag housing.

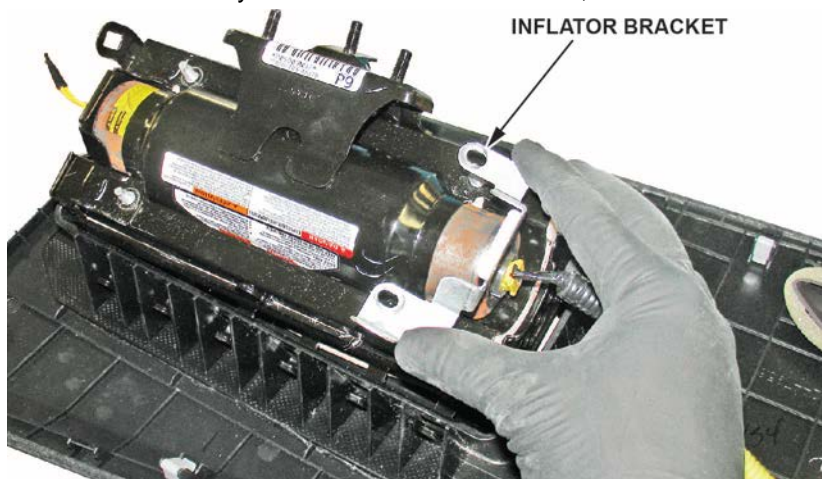

8. Remove the inflator by pushing it out.

NOTE: The inflator fits more snugly than other front passenger side inflators installed in other vehicles and needs more force to remove it.



9. Install the new inflator.

- One terminal looks like a "D" whereas the other terminal is a circle. Remove the sticker covering the terminal from the "D" side and insert it into the airbag first.

D-SHAPED TERMINAL
A white sticker covers the terminal.



NEW INFLATOR
The D-shaped terminal goes in first.



- Slide the inflator in until the "D" aligns with the tab on the inflator bracket. There should be no space or gap between the inflator and bracket.

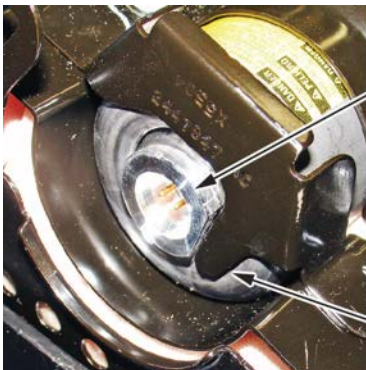

D-SHAPED END

TAB ON THE BRACKET



NO GAP BETWEEN THE INFLATOR AND THE BRACKET

- Reinstall the inflator bracket. There should be no space or gap between the bracket and inflator.

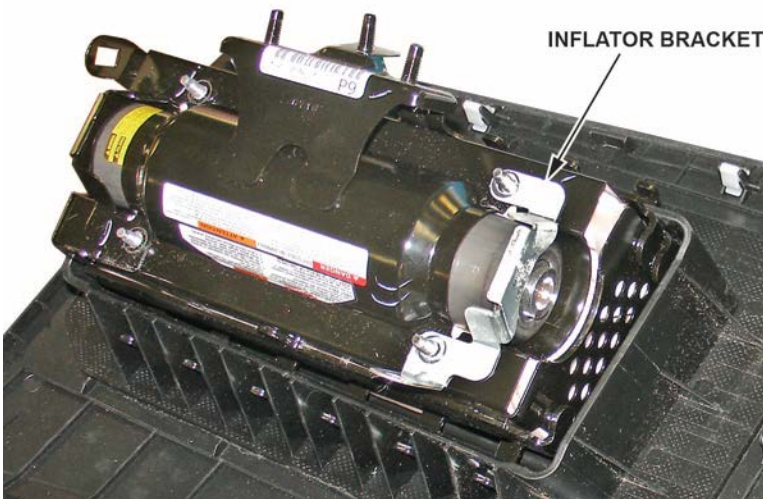

INFLATOR BRACKET

10. Install the new 5 mm locknuts and torque them in sequence to **3.9 N•m (34 lb-in)**.

Be sure there are no gaps between the inflator ends and the inflator brackets.

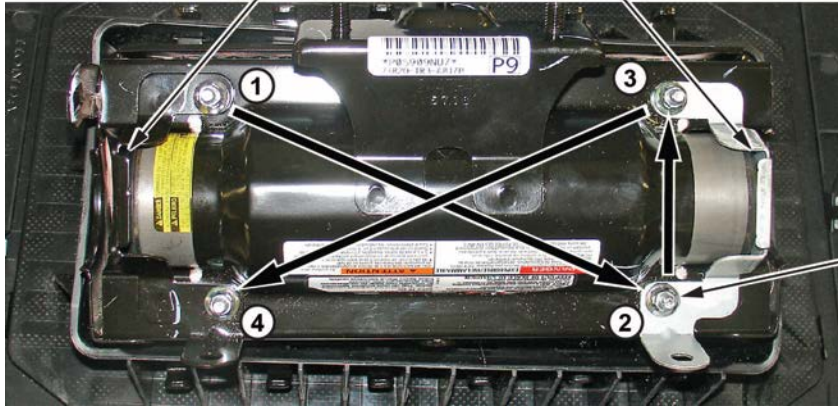

LOCK NUTS (4)
3.9 N•m (34 lb-in)

11. Remove the other sticker covering the inflator terminal.

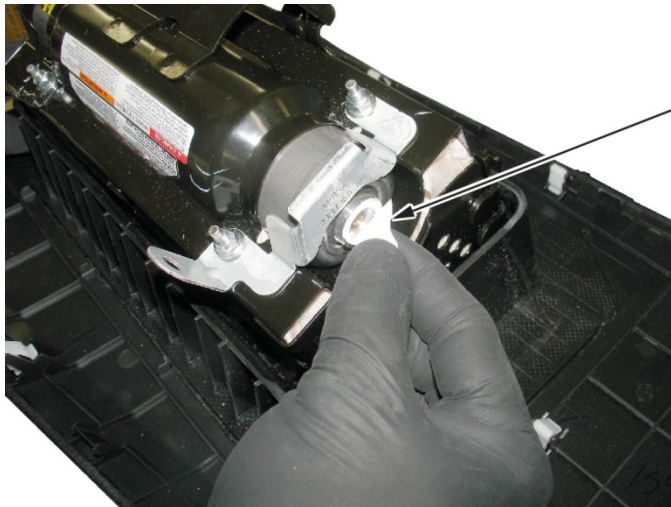

**STICKER COVERING
TERMINAL**

12. Install the new inflator harness.

- Make sure the airbag and harness are aligned as shown.

NOTE: Make sure you have the orientation correct as shown below. If you connect the harness incorrectly, the harness cannot be removed, and you will not be able to reinstall the airbag because the harness will be too short.

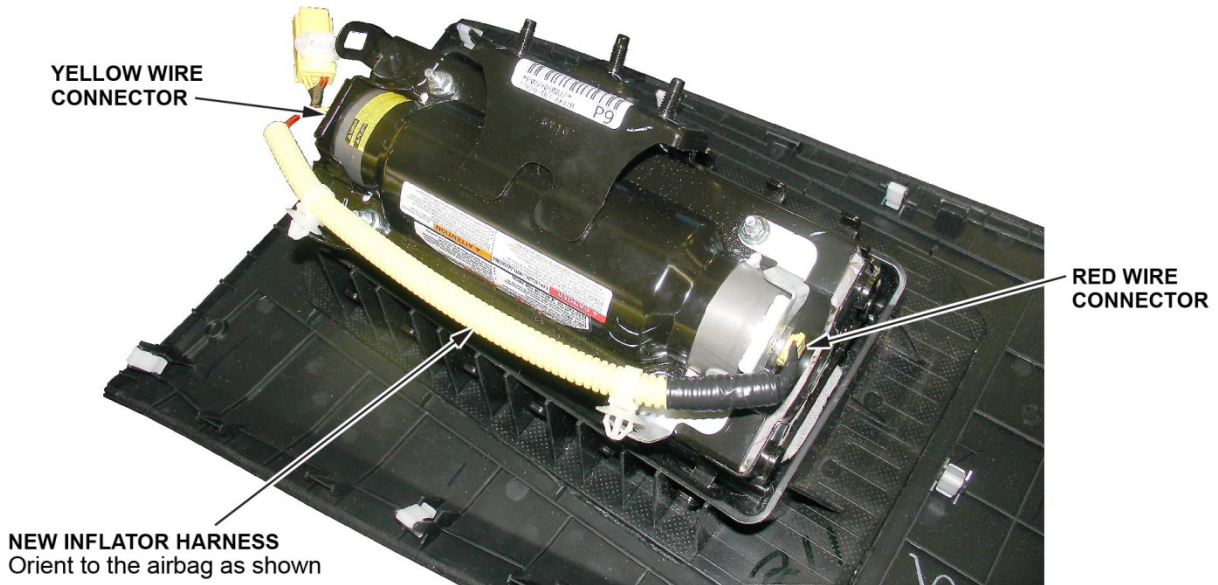

- Connect the two connectors. Align the "T" shape in the inflator harness connector with the T-shaped inflator connector, then press the connector into place.

① Match up the "T" shape as shown. The connectors are directional.

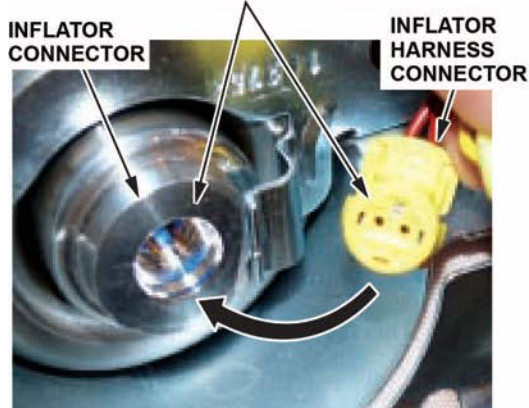

② Press the connector into place until it clicks.

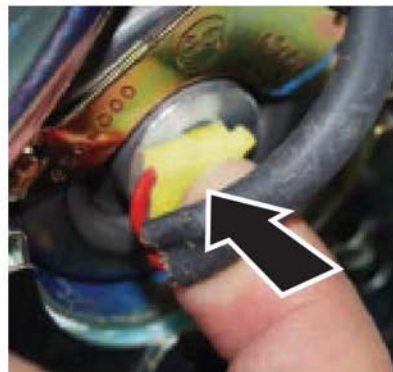

③ Wiggle the connector to make sure it's secure.



- After you hear each connector click, wiggle it to make sure it is secure.
NOTE: If the connector is not properly aligned, it will come out.

13. Connect the harness to the inflator brackets.

- Insert the side without the shrink-wrap tubing first.
- Insert the side of the harness with the shrink-wrap tubing into the inflator bracket. Make sure the harness is securely inserted and that it does not sag.
- Connect the harness clips to the inflator brackets as shown.

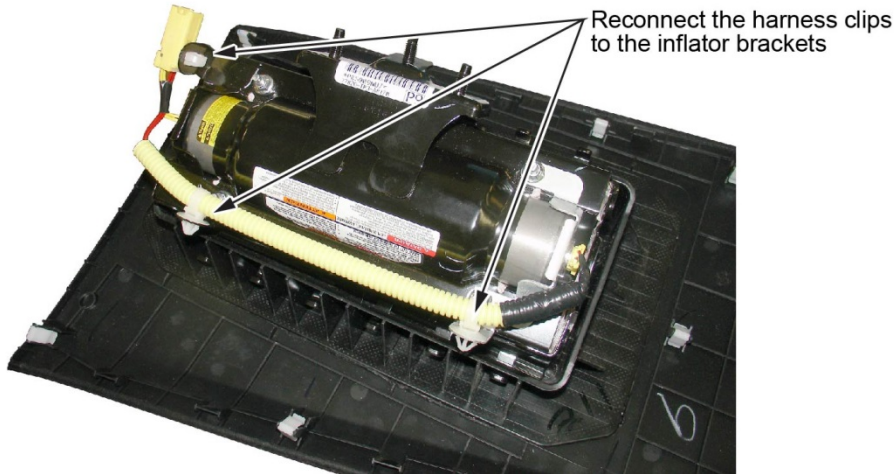

14. Reinstall the front passenger's airbag into the vehicle. Reinstall the screws and torque the new 6 mm mounting nuts to **9.8 N•m (7.2 lb-ft)**.

15. Reinstall the remaining parts in the reverse order of removal.

NOTE: Make sure you install the one-time use upper clip from the kit to reattach the A-pillar trim.

16. Reconnect the battery negative cable.

17. Start the engine and check that the SRS indicator comes on for about 6 seconds, then goes off.

18. Press and hold the radio power button to exit the anti-theft mode.

Returning the front passenger's airbag inflator

19. Put the original inflator with the attached harness into the box that the new one came in. Make sure there is no other hardware in the box because if the package rattles, it will not be accepted by the courier.

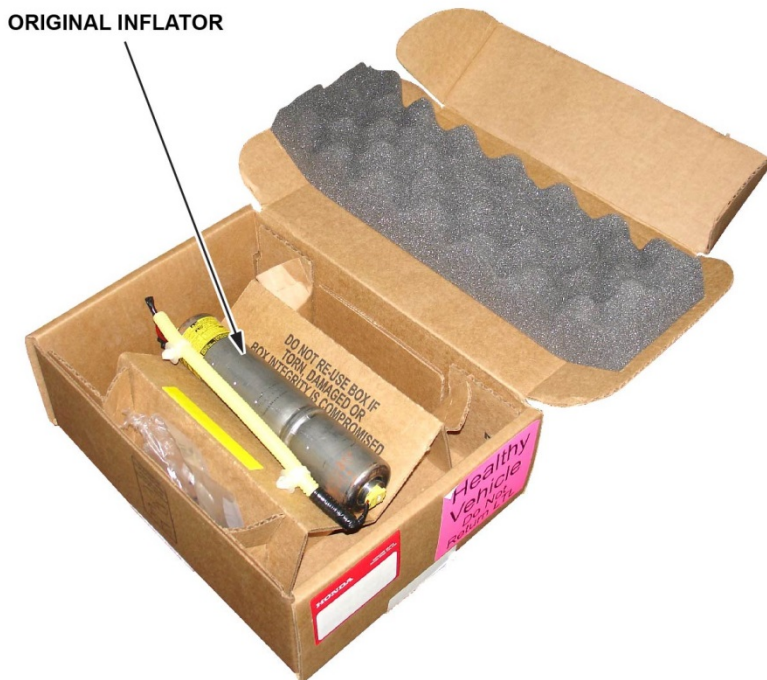

20. Follow the shipping instructions supplied with the inflator kit to return the undeployed inflator. If you have any questions about shipping, call Warranty Parts Inspection (WPI) at **937-642-2737**.

NOTE: Boxes containing the 2012 Civic collection front passenger's airbag inflators have a pink sticker on the outside of the boxes to distinguish them from other returns. These boxes need to be shipped by FedEx.



21. Give your warranty clerk the RO that includes the inflator serial number and replacement part number. For the warranty claim to be paid, the **replacement inflator part number** must be on the warranty claim and your warranty clerk must enter the serial number in the serial number field.

END