

Subject: AUDIO, NAVIGATION AND PHONE CONCERNS WITH MAZDA CONNECT INFOTAINMENT SYSTEM	Bulletin No: 09-024/16
	Last Issued: 04/19/2016

BULLETIN NOTE

All Mazda Connect vehicles in new car inventory must be updated to this software version listed below in this TSB as part of the New Car Ready Step 3 process. Make sure the new vehicle specialist receives a copy of this bulletin.

This bulletin supersedes the previously issued bulletin(s) listed below. The changes are noted below in Red beside the change bars.

Previously Issued TSBs:	Date(s) Issued
09-022/15	08/10/15, 06/02/15, 06/10/15 and 07/01/15
09-006/14	01/24/14, 03/25/14, 03/28/14, 04/23/14, 05/01/14, 06/05/14 and 09/16/14
09-034/13 (MSP41)	12/4/13

APPLICABLE MODEL(S)/VINS

- 2014-16 Mazda3
- 2016 Mazda6
- 2016 CX-3
- 2016 CX-5
- 2016 MX-5

DESCRIPTION

Some vehicles may experience the symptoms mentioned below, which can be fixed with the latest software update (Version 56.00.760 or later).

- Some street names in Canada are not displayed.
- Navigation does not allow to set certain cities as destination.
- Navigation does not announce voice guidance for street names.
- Navigation turns to a black screen remaining the task bar.
- Turn -by-turn navigation guidance does not display on on the active driving display (for vehicles with 55.00.750).
- Every time the navigation is turned on, the vehicle position starts from the location (dealer) where the CMU was updated from version 55.00.650 to 55.00.750.
- Navigation or other screen turn black, freeze or reboot.
- System does not recognize USB/SD card.

CONSUMER NOTICE: The information and instructions in this bulletin are intended for use by skilled technicians. Mazda technicians utilize the proper tools/equipment and take training to correctly and safely maintain Mazda vehicles. These instructions should not be performed by "do-it-yourselfers." Customers should not assume this bulletin applies to their vehicle or that their vehicle will develop the described concern. To determine if the information applies, customers should contact their nearest authorized Mazda dealership. Mazda North American Operations reserves the right to alter the specifications and contents of this bulletin without obligation or advance notice. All rights reserved. No part of this bulletin may be reproduced in any form or by any means, electronic or mechanical---including photocopying and recording and the use of any kind of information storage and retrieval system ---without permission in writing.

- Some menu of music source selection is grayed out.
- When using the call button on the cell phone to make a call, the call sound is short.
- Favorites disappear.
- Vehicle current position is not accurate enough.
- Rear view monitor does not show up on screen.
- Text information of HD radio is not displayed when switching music source.
- When asking for current location with voice command “Where am I?”, the system responds with “Your location is comma.”
- Contact information cannot be loaded correctly from phones other than iPhone.

NOTE: Mazda is working to make further improvements to the Mazda Connect Infotainment System software, and may issue future software updates to improve system operation and performance. Software version updates can be found on MS3 under IDS/Infotainment.

Customers having any of these concern should have their vehicle repaired using the following repair procedure.

REPAIR PROCEDURE

1. Verify customer concern.
2. Update MAZDA CONNECT with software version **56.00.760** or later using the following instructions.

CAUTION: More than one software version can be placed on a memory stick, but Mazda recommends placing only one version on a memory stick to avoid updating the system with the wrong version.

MAZDA CONNECT Software Version Verification Procedure

1. Select “Settings” from the Home screen to check the software version.

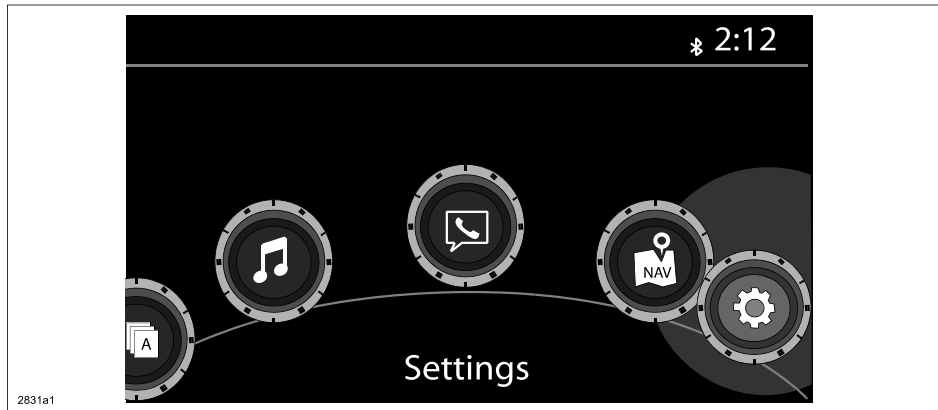

2. Select "System" and scroll down to the "About" option.

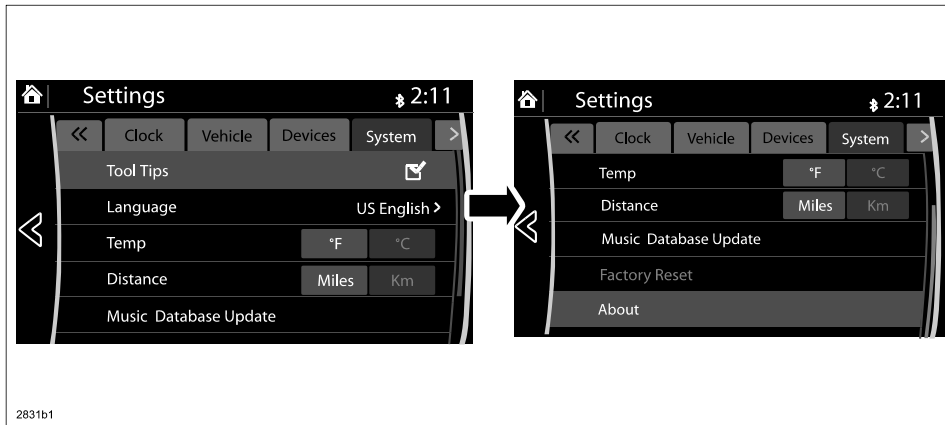

3. Select "Version Info" from the "About" screen.

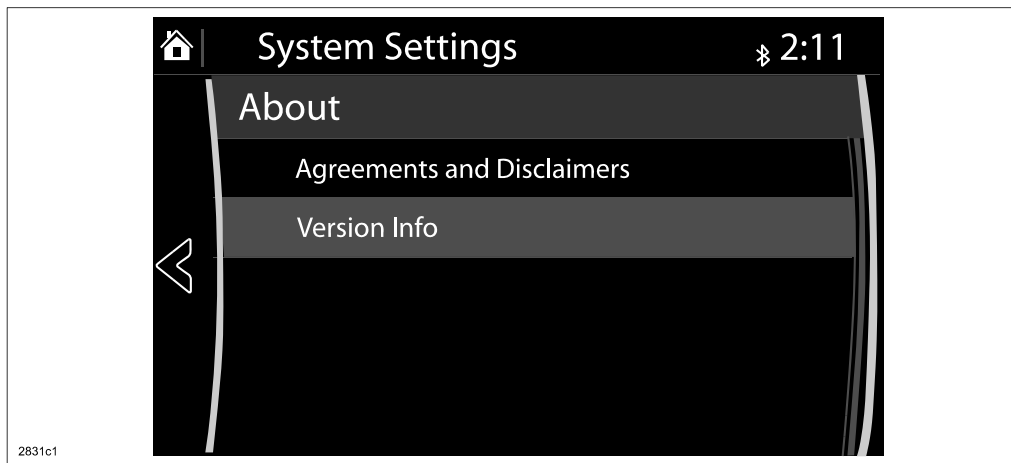

4. Make sure the software version is **56.00.760** or later, then select OK. If it is not **56.00.760** or later, update the system using a USB memory stick with the latest software according to the "Reflash Procedure." If needed, refer to "Downloading Update Software to a USB Memory Stick (for additional USB memory sticks)" below.



Downloading Update Software to a USB Memory Stick (for additional USB memory sticks)

1. Install the USB memory stick with a minimum 2G of memory into the USB port of a computer with internet access.

NOTE: The update files can also be copied from one USB memory stick to another.

2. Go to "Start" and select "Computer," then double-click on the memory stick "removable disk" (A).

NOTE: The memory stick may have a different name. Look for "Removable Disk."

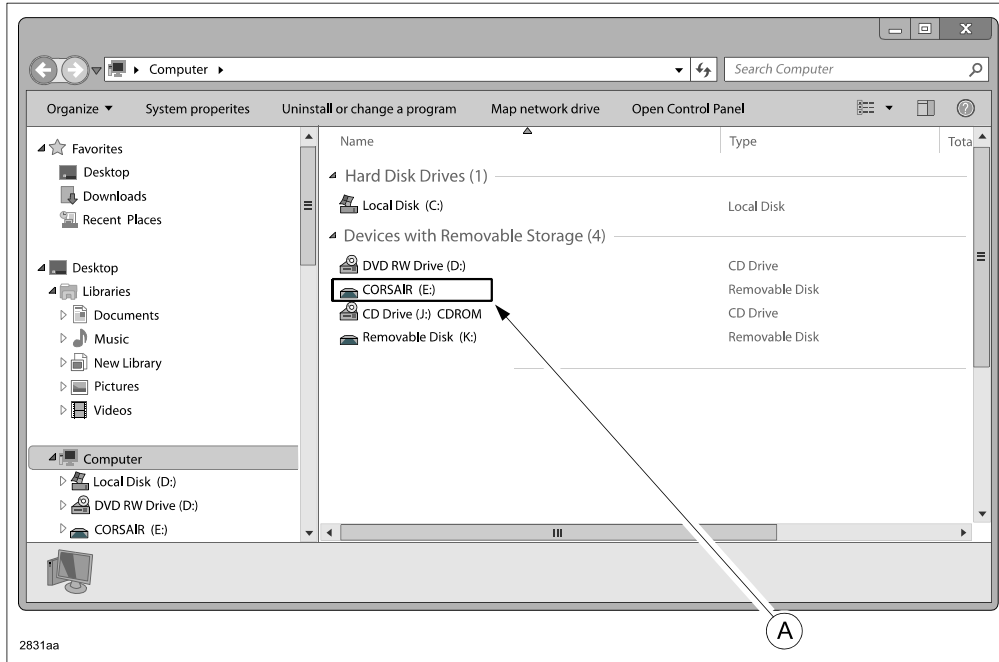

3. Delete any existing files (A).

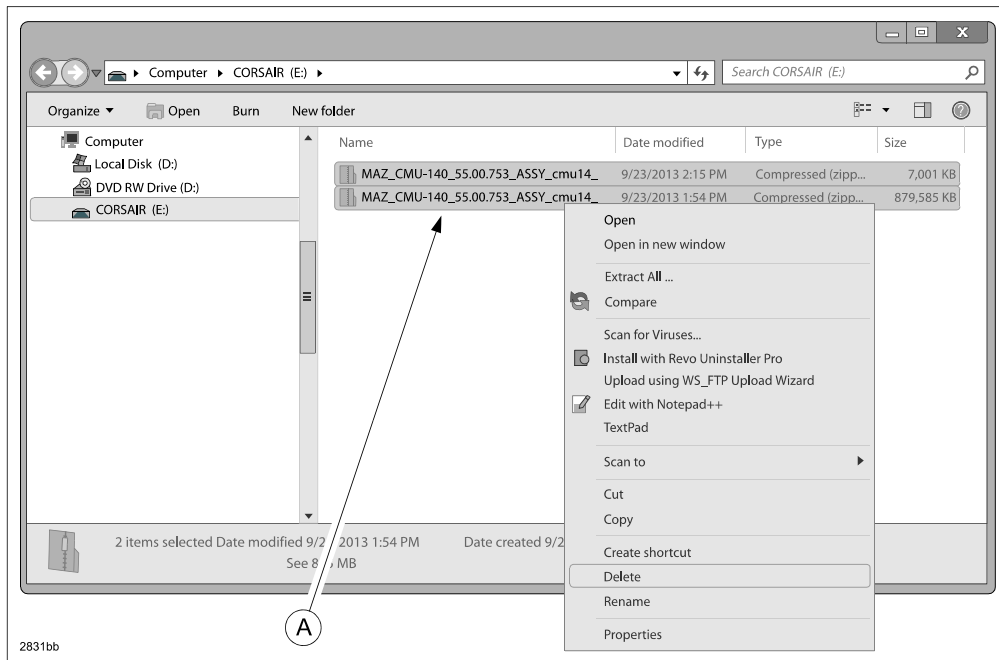

4. Confirm that no files are left on the memory stick.

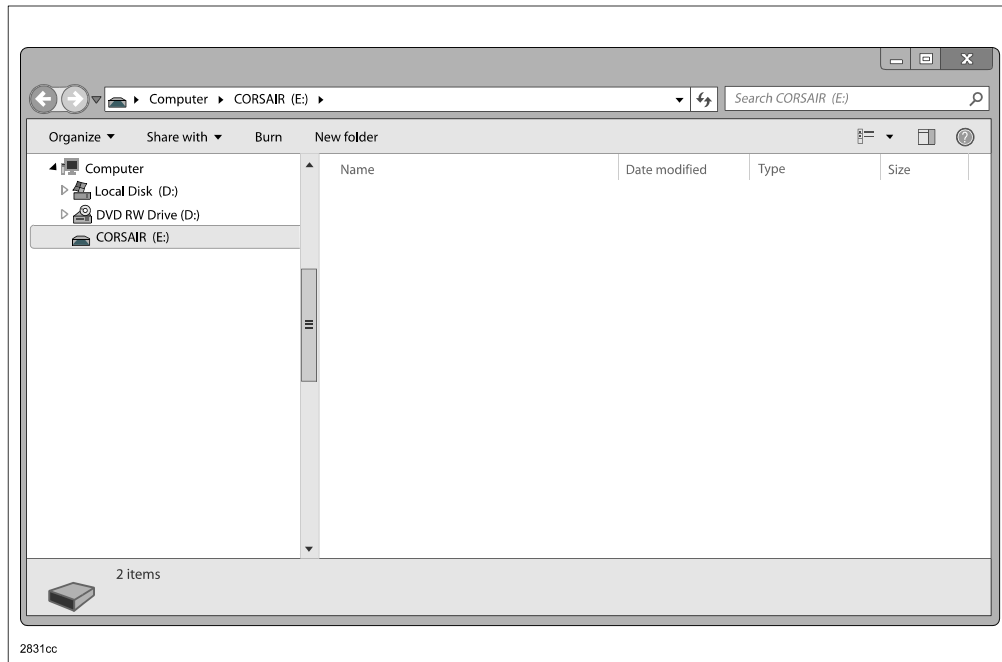

5. Log on to MS3 and select "IDS/Infotainment."

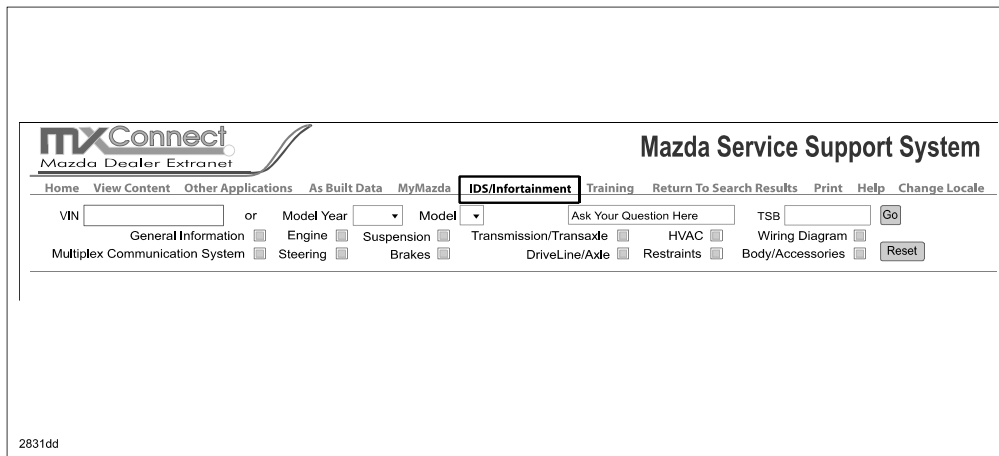

6. Select “Mazda Connect Updates.”

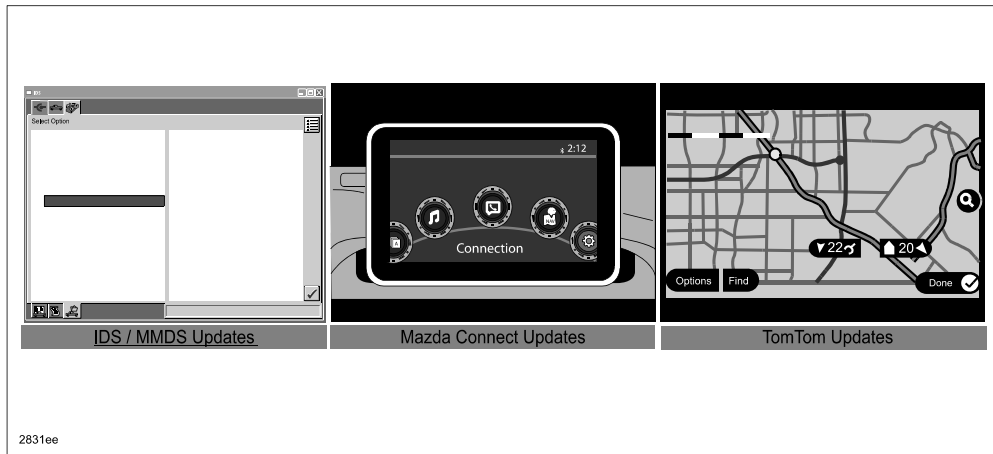

7. Select the FailSafe file (A) and “Save.”

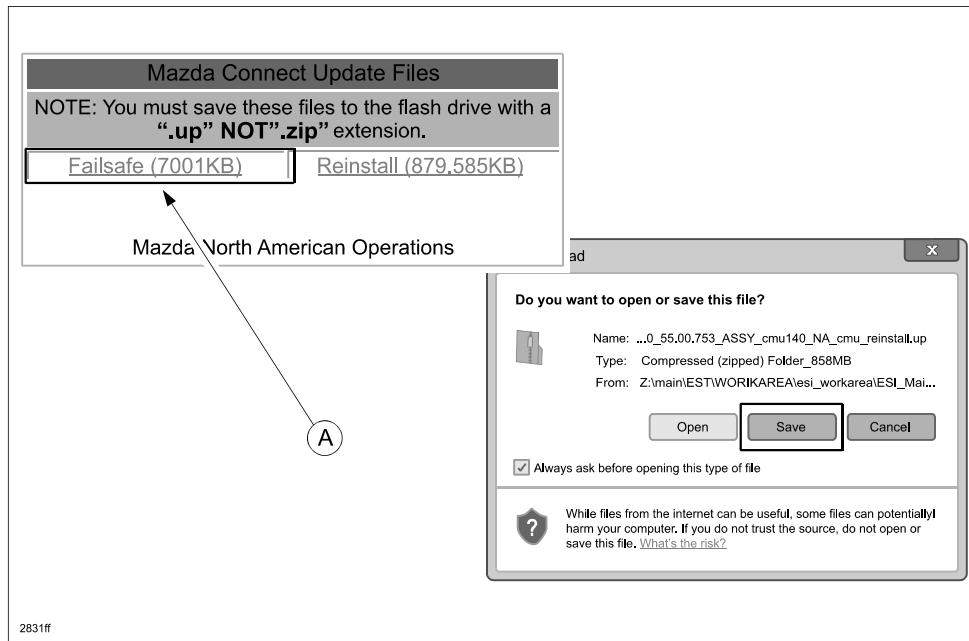

8. Change the file extension from “.zip” to “.up” (A).

NOTE: If you do not save the file with a “.up” file extension, you will have to delete the download and start again.

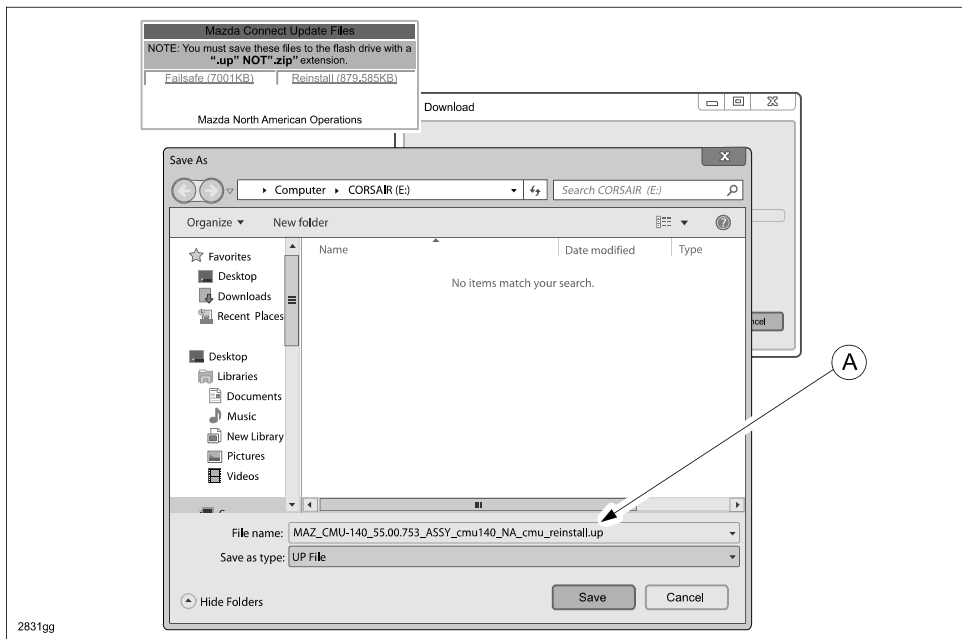

9. Save the file to the memory stick.

10. Repeat step 7, 8, and 9 for the Reinstall file.

11. After completing the downloads, compare the size of the files to the ones on the download page.

- If the size is the same, proceed to the reflash procedure.
- If the size is not the same, delete the files on the memory stick and start over.

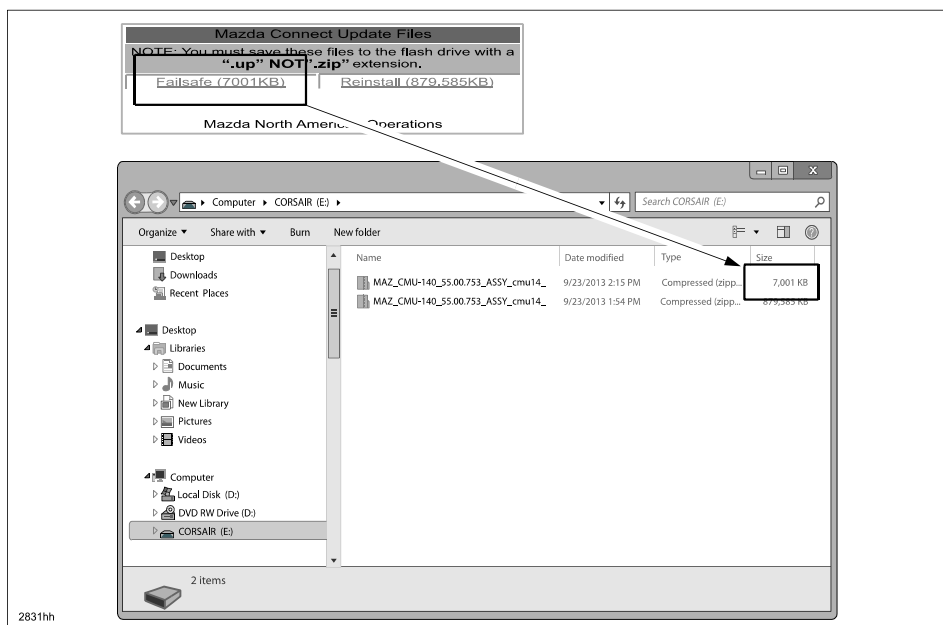

Reflash Procedure

NOTE: When the system is updated, all factory defaults are restored and personal settings (such as display and sound adjustments) are lost, including favorites information and phones paired with the system. Before starting the reflash procedure, obtain the customer's acceptance for this loss.

1. Record the customer's radio favorites (AM/FM/XM).
2. Turn the ignition switch to OFF.

NOTE: All electrical loads should be turned off during the reflashing process, especially the air conditioner (blower), rear defogger, and room lamps.

3. Remove the SD card from the slot and any USB devices if present.
4. Install the ROOM FUSE and AUDIO FUSE to the fuse block in the engine compartment (if not installed).
5. Connect battery charger (charge current maintained about 7A) to the vehicle to stabilize voltage fluctuation.
6. Press the START/STOP ENGINE push button 1 time without depressing the clutch pedal (manual transaxle) or the brake pedal (automatic transaxle), to switch the ignition position to ACC. Confirm that the push button start indicator light (A) is illuminated (amber) and the display in the instrument cluster is OFF (ignition position is in ACC).

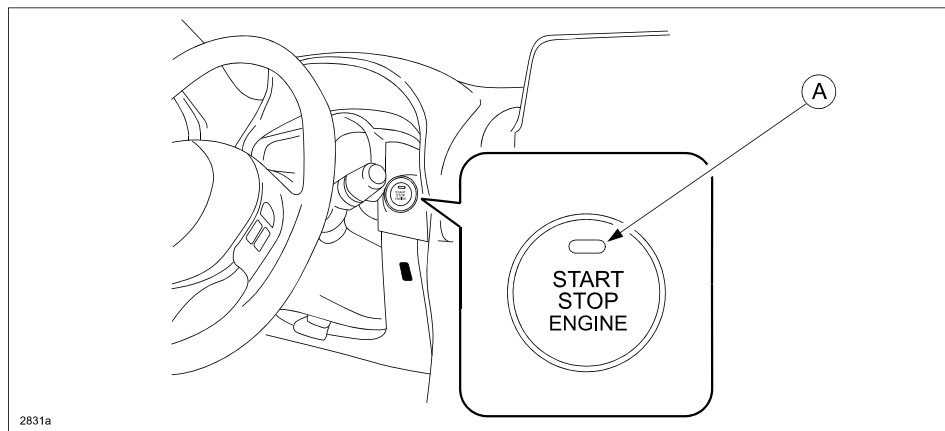

NOTE: The engine starts by pressing the push button start while depressing the clutch pedal (manual transaxle) or the brake pedal (automatic transaxle). To switch the ignition position without starting the engine, press the START/STOP ENGINE push button without depressing the pedal.

NOTE: If the ignition is left in the ACC position it will automatically switch off after 25 minutes. Pressing and releasing the clutch pedal (Manual Transaxle) or the brake pedal (Automatic Transaxle) before 25 minutes resets the timer to ensure the vehicle does not switch off during the reflash process.

7. **Select the radio source (AM/FM/XM)** and verify that there is a sound coming from the speakers. If sound cannot be heard, turn the volume dial (A) to turn the volume up, or make sure that MUTE is not on.

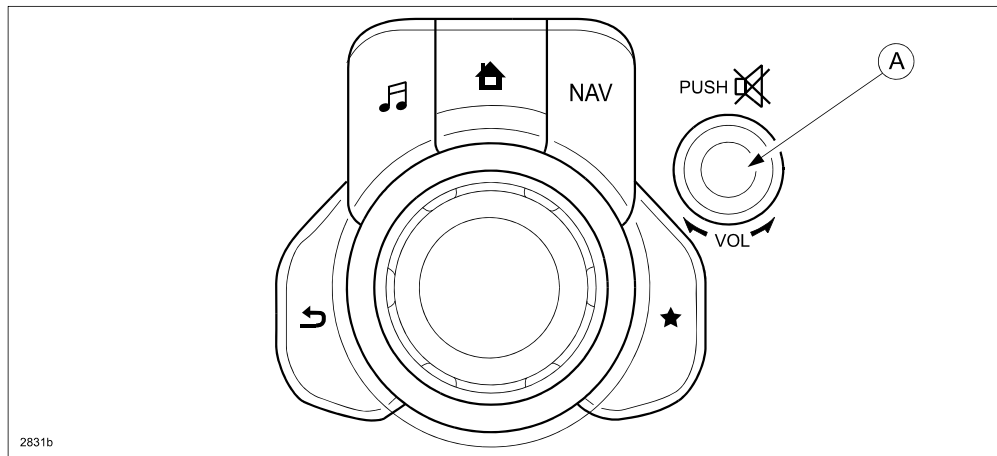

NOTE: When sound is heard from the speakers, the system is in stand-by condition.

8. Press the three buttons (Music (A) + Favorites (B) + Volume Mute(C)) on the commander switch at the same time for 2-5 seconds and the Diagnostic Test Screen will appear.

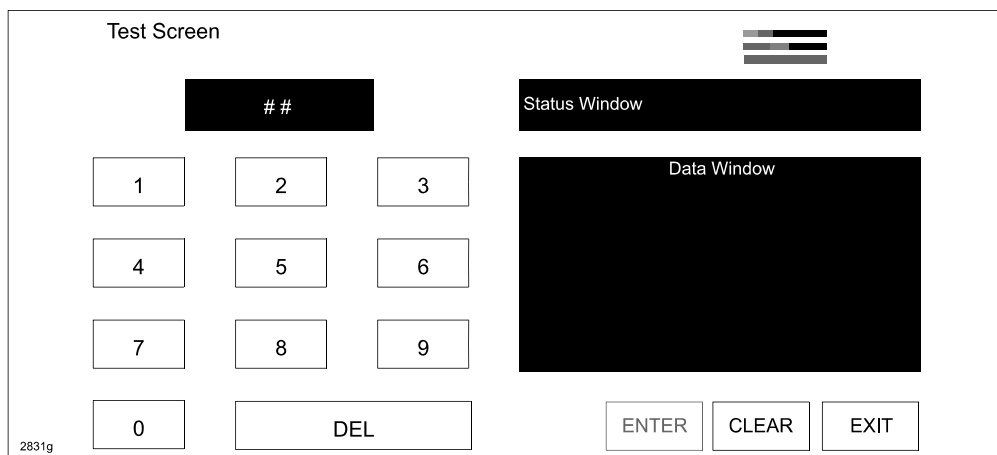
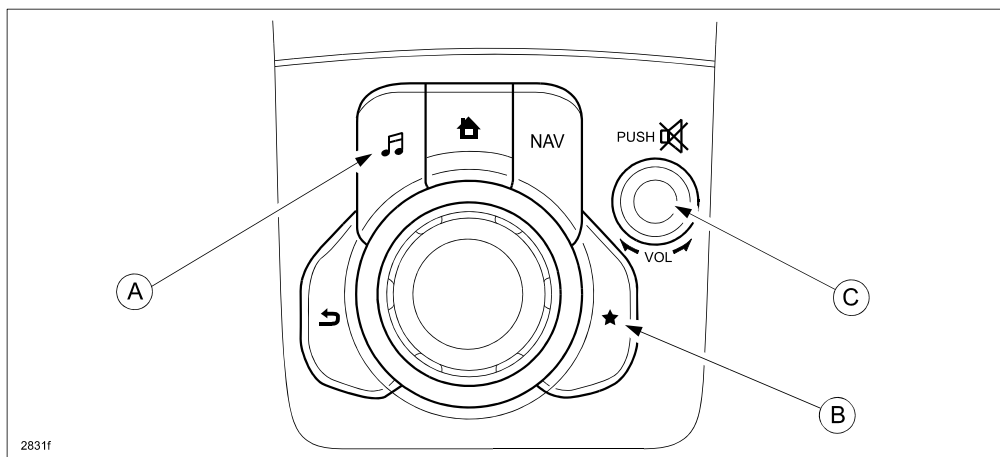

9. On the test screen, input '3' and then select "ENTER" to verify whether any DTCs (in the CMU) are active. Select "CLEAR" to go to next step.

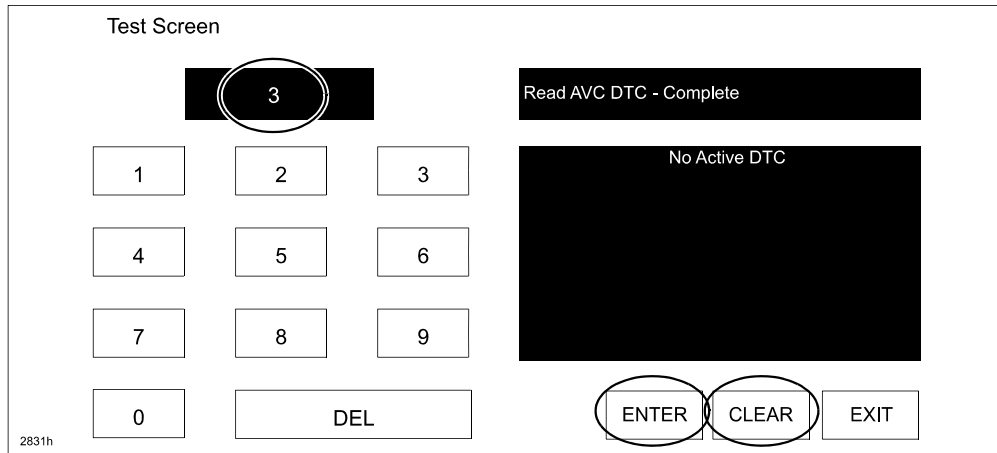

10. Whether any DTCs are present or not, input '2' on the test screen and then select "ENTER". This will internally clear all the earlier set DTCs (in the CMU). Select "CLEAR" to go to next step.

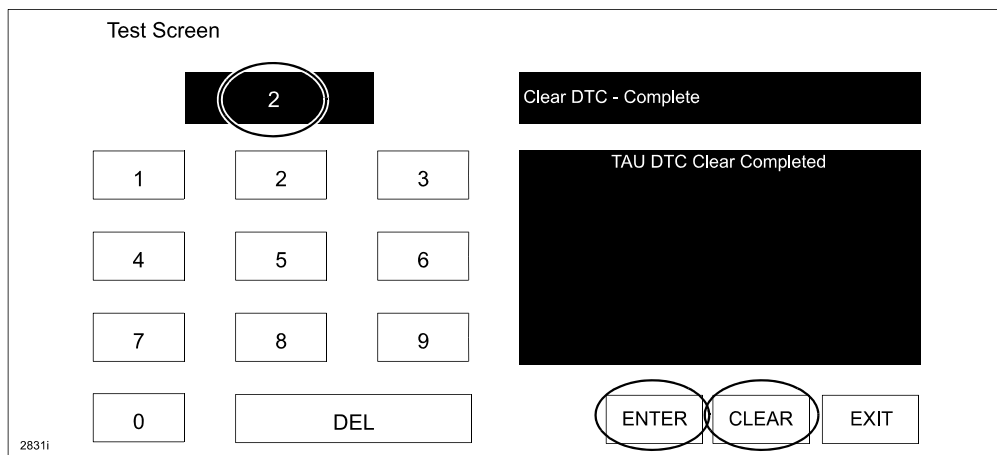

11. To complete the DTC deletion, press the START/STOP push button to turn the ignition OFF and remove all key fobs from the vehicle and lock all doors (except hood), wait for 3 minutes.
12. Press the START/STOP ENGINE push button 1 time without depressing the clutch pedal (manual transaxle) or the brake pedal (automatic transaxle), to switch the ignition position to ACC.

13. Connect the prepared USB memory stick to the either one of the two USB port (A), depending on vehicle equipment.

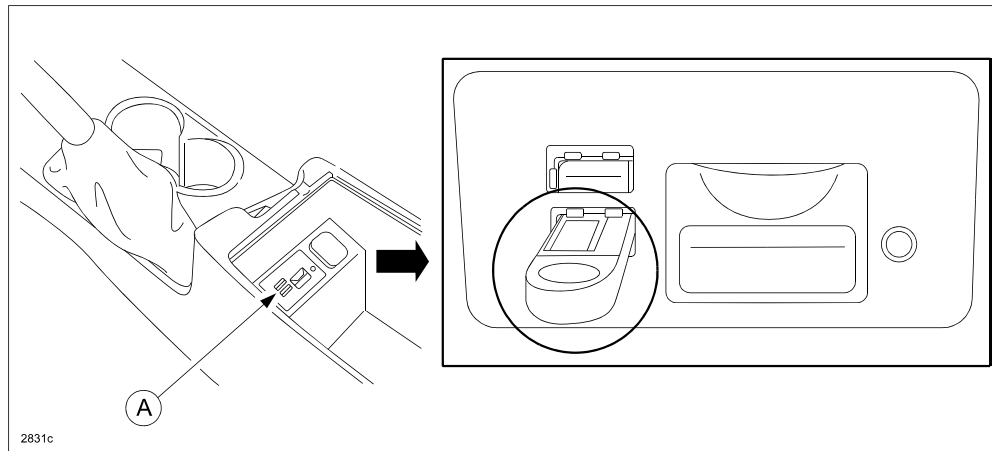

NOTE: There should only be the prepared USB memory stick inserted in one of the USB ports. Nothing else should be inserted in the other USB port during the re-flashing process.

14. When the USB memory stick is recognized, the following message will appear briefly on the screen.

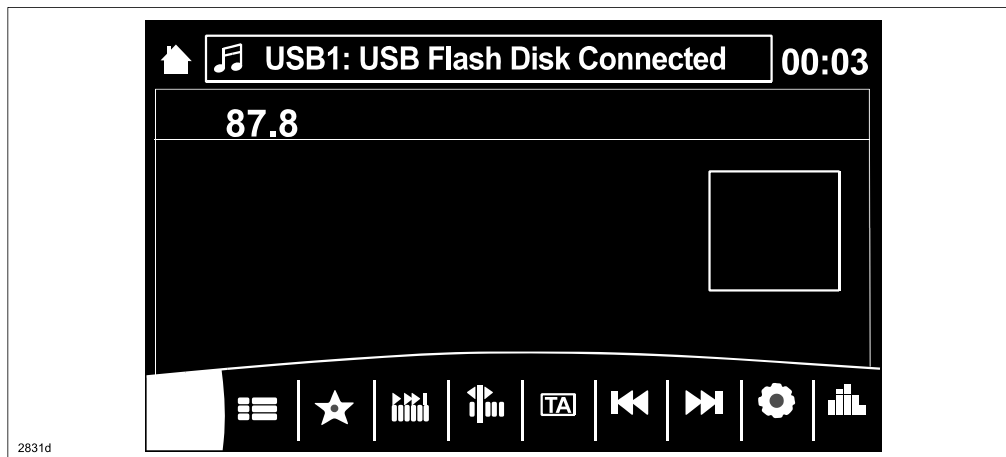

NOTE: If the USB memory stick is not recognized by the system, return to step 11.

15. Press the three buttons (Music (A) + Favorites (B) + Volume Mute(C)) on the commander switch at the same time for 2-5 seconds.

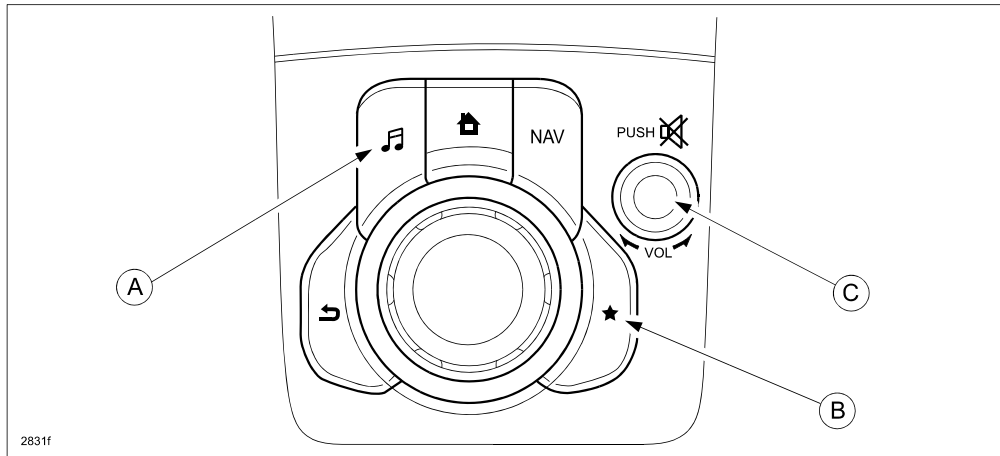

16. Use the touchscreen or the commander switch to input '99' and then select "ENTER" on the Test screen.

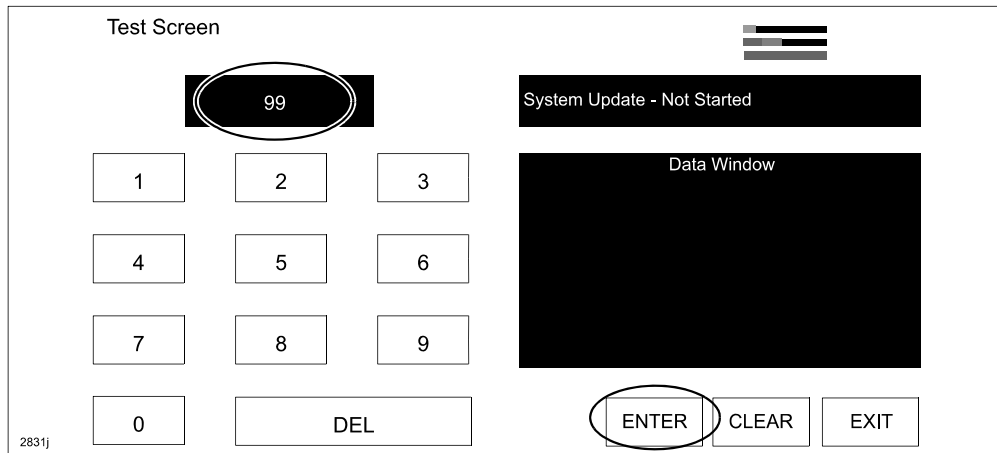

17. Select "Search" on the screen below.

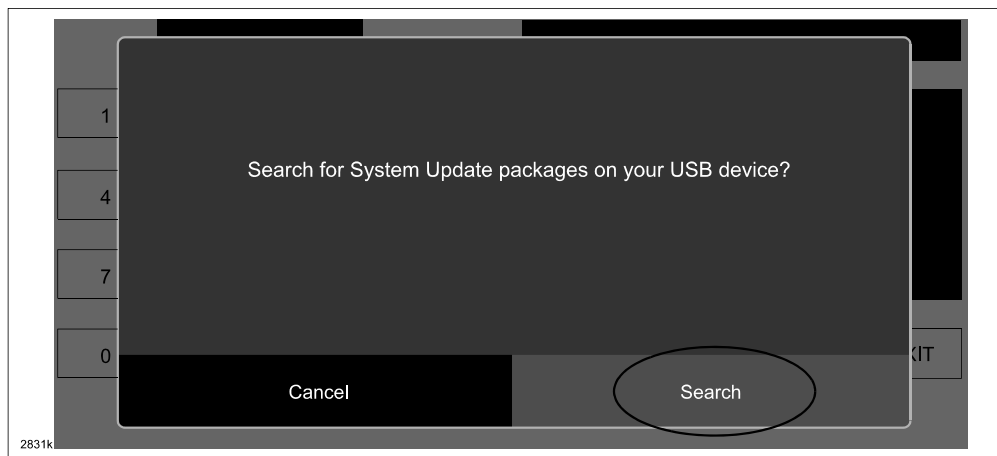

18. Select "Fail Safe Package" first using the touch screen.

CAUTION: Always do the "Fail Safe Package" first, followed by "Reinstallation Package".

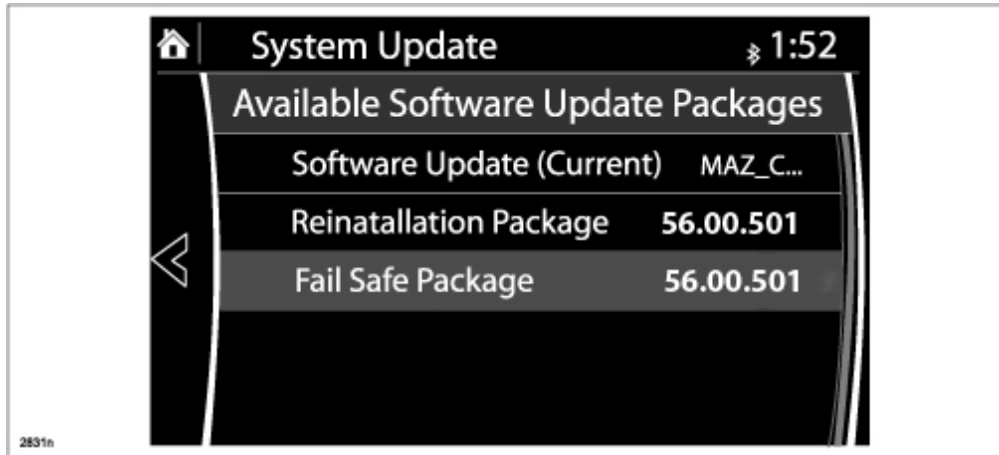

19. Select "Install" on the screen below.

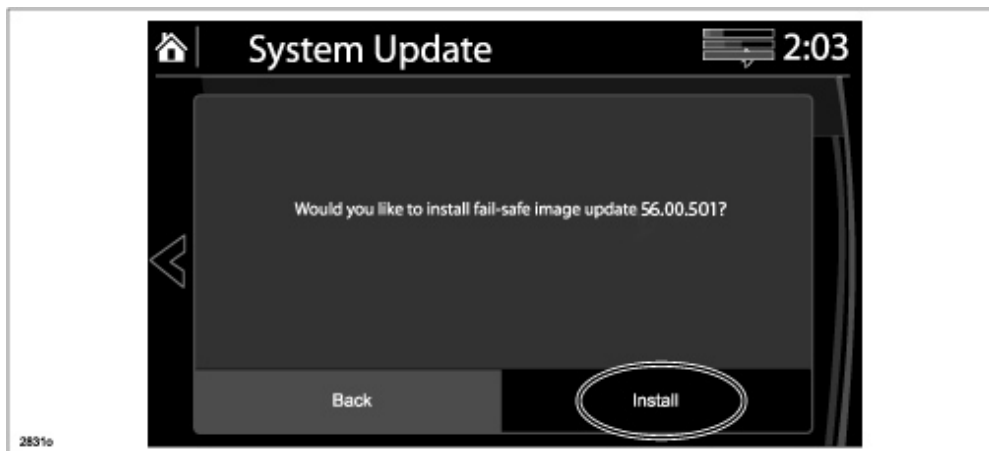

20. Failsafe installation process will start.

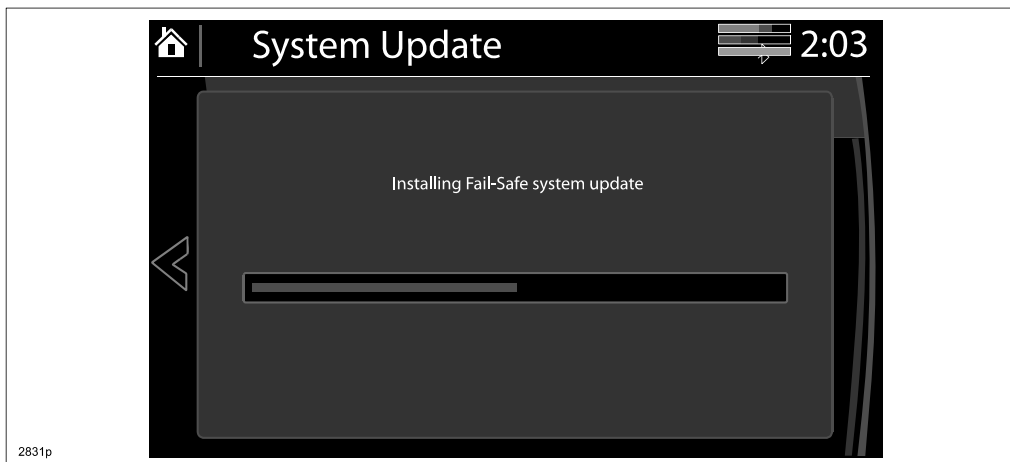

21. After the Failsafe installation process is completed, select "OK".

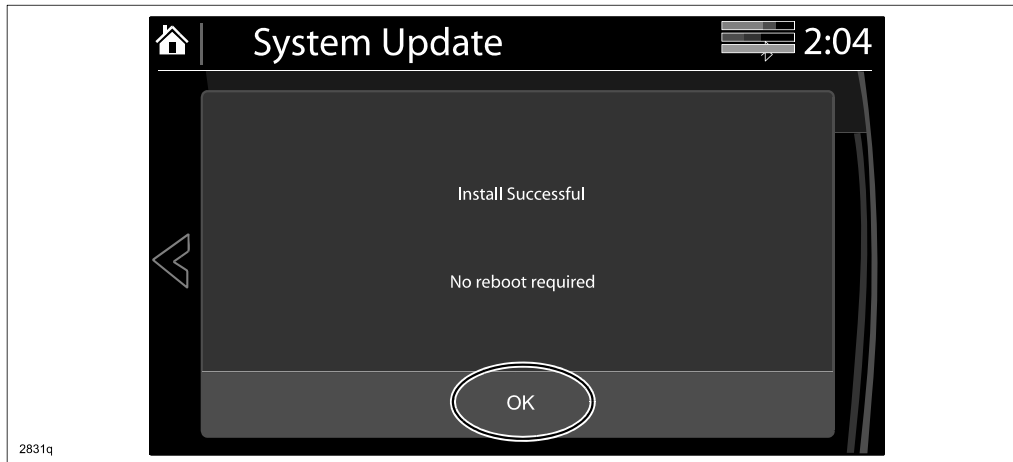

22. Press and release the clutch pedal (Manual Transaxle) or the brake pedal (Automatic Transaxle) and proceed with the following steps without stopping.

NOTE: If the ignition is left in the ACC position it will automatically switch off after 25 minutes. Performing this step resets the timer to ensure the vehicle does not switch off while installing the reinstatement package.

23. Press the three buttons (Music (A) + Favorites (B) + Volume Mute(C)) on the commander switch at the same time for 2-5 seconds to open the Diagnostics Test screen again.

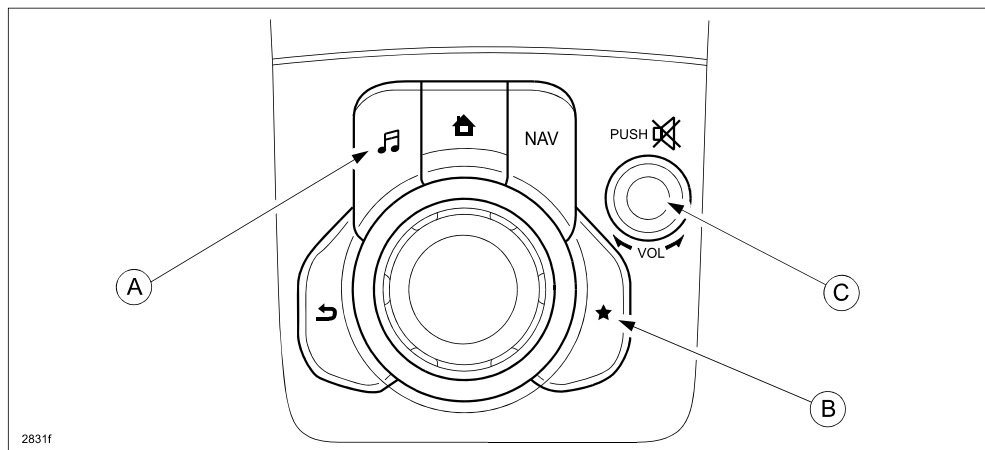

24. Use the touchscreen or the commander switch to input '99' and then select "ENTER" on the Test screen.

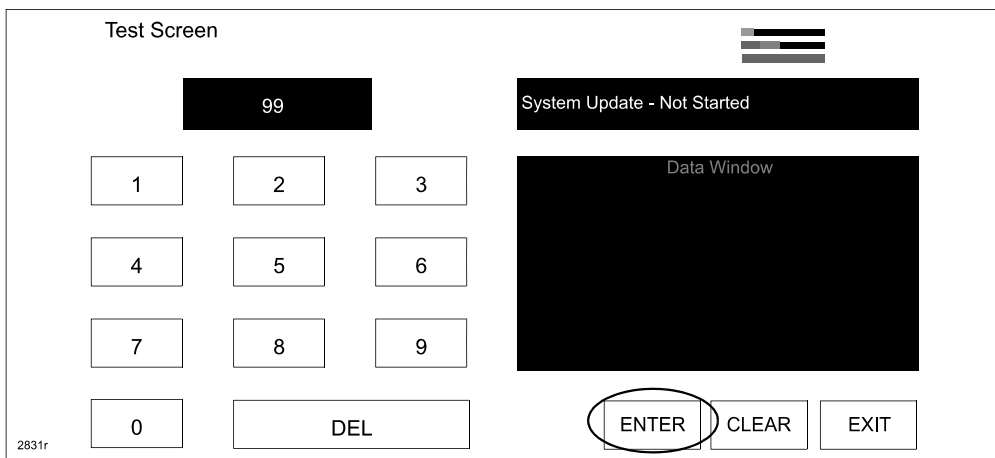

25. Select "Search" on the screen below.

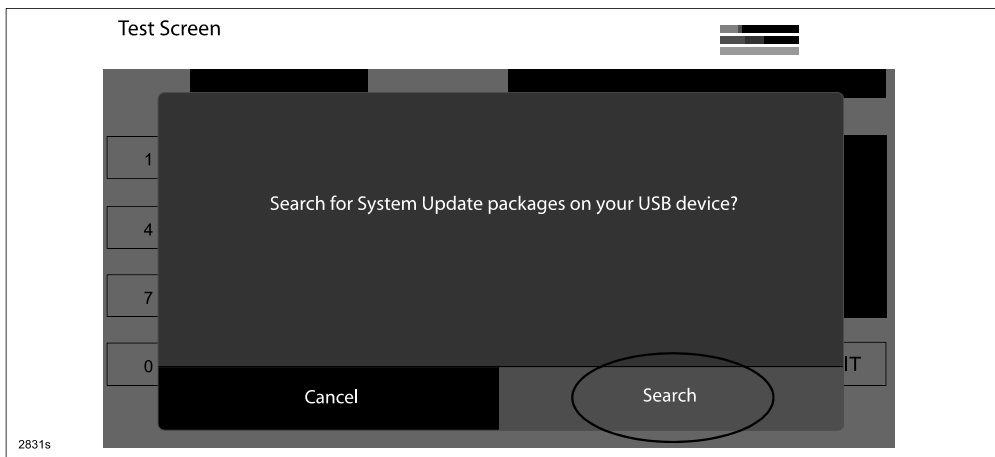

26. Select "Reinstallation Package" on the screen below.

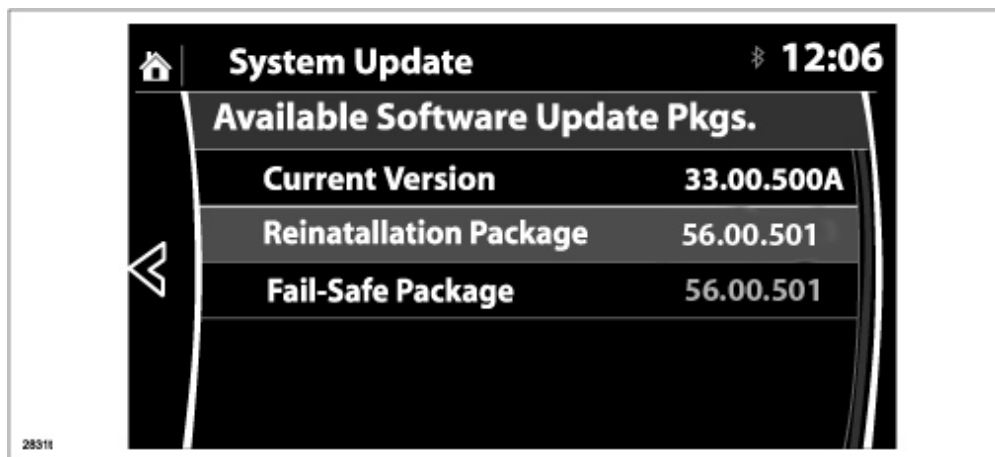

27. Select "Install" on the screen below.

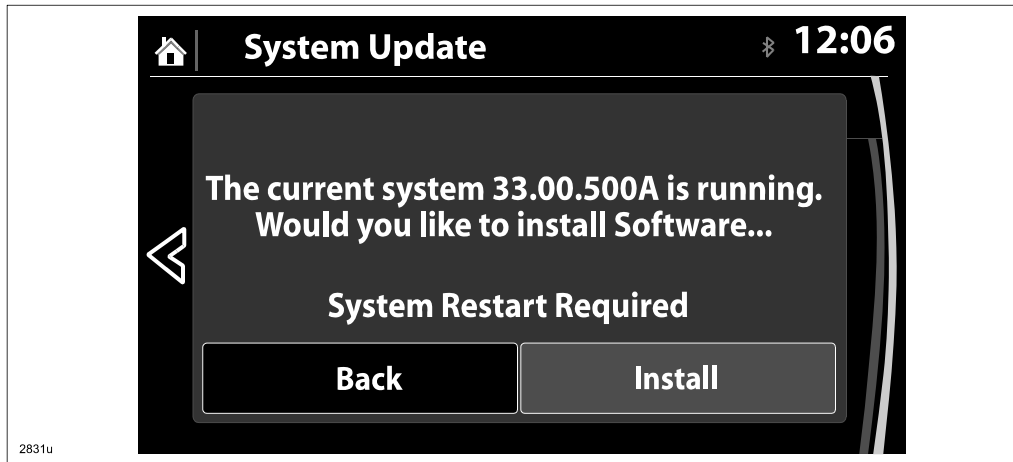

28. The screen below will be displayed.

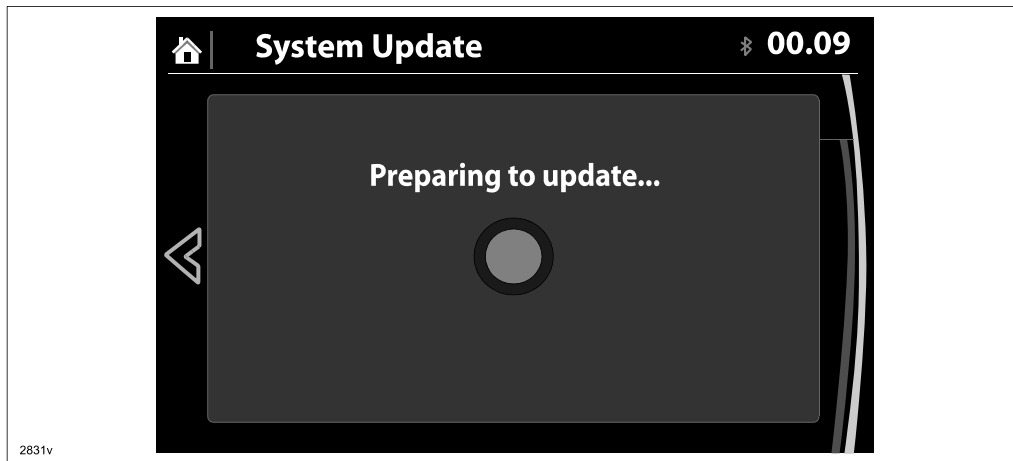

NOTE: Blank screens (black and white) are displayed momentarily. It will take approx. 2 minutes before the reflashing process moves to the next screen.

29. Reinstallation will start from 0% and as the reflashing process takes place, the progress bar will gradually increase to 100%.

NOTE: In order to avoid the ACC power being turned off during the reflashing process, press and release the clutch pedal (Manual Transaxle) or the brake pedal (Automatic Transaxle) before 25 minutes if needed.

NOTE: It may be difficult to read the display at times as it becomes dark, but “Do not restart vehicle at this time” is displayed.

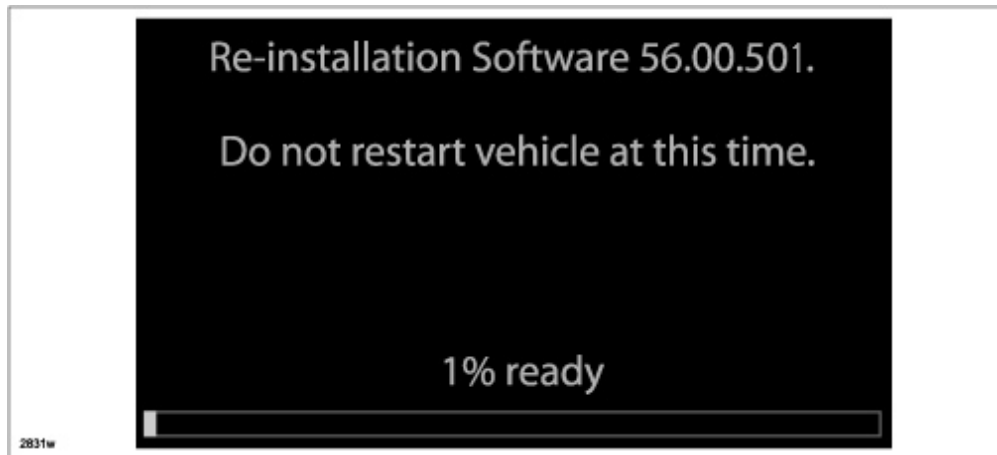

CAUTION: DO NOT turn the the ignition ON to avoid damaging the CMU.

NOTE: It will take some time for the reflashing process to get from 98 % to “100%. After the installation, do not follow “re-start” message. Proceed to next step.

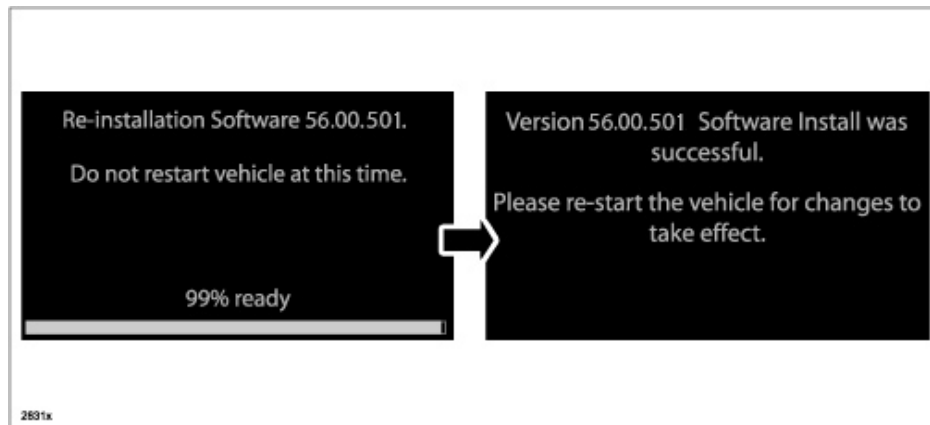

30. After the update is completed with the above right screen, confirm that the push button start indicator light is illuminated (amber) and the display in the instrument cluster is OFF (ignition is in "ACC"). If the ignition is "OFF" and the push button start indicator light is not illuminated (amber), turn the ignition to "ACC" and one of the following two screens will be displayed.

Type A: Reprogramming has already been completed. Go to next step.

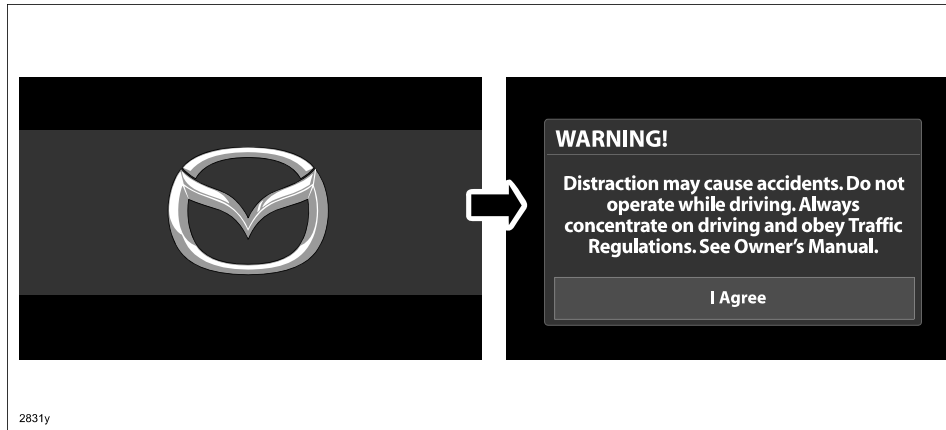

Type B: The ignition was turned "OFF" during the reflashing process. This screen will continue to be displayed until reflashing is completed. After the reflashing is completed, go to next step.



Updating process will not finish:

After the task bar is shown, if the screen turns to white or freezes without showing a completion screen, follow this step:

- a. Push the START/STOP button to turn the ignition switch OFF.

NOTE: DO NOT start the engine.

- b. Wait until the screen turns to black.
- c. Remove the USB memory stick.
- d. Remove ROOM fuse and wait for one minute.
- e. Install ROOM fuse.
- f. Press the START/STOP ENGINE push button 1 time without depressing the clutch pedal (manual transaxle) or the brake pedal (automatic transaxle) to switch the ignition position to ACC.

NOTE: DO NOT start the engine.

g. Confirm the screen shown below appears.



h. Connect the USB memory stick to the USB port.

i. Confirm the task bar appears on screen.

31. Push the START/STOP button to turn the ignition switch OFF.

32. To stabilize the system, turn IG off and remove all key fobs from the vehicle and lock all doors (except hood), wait for 3 minutes.

33. Press the START/STOP ENGINE push button 1 time without depressing the clutch pedal (manual transaxle) or the brake pedal (automatic transaxle) to switch the ignition position to ACC.

34. After the system starts, wait for a minute without any operation to have the configuration finished. (Ignition switch may be at ON and the vehicle may be driven.)

35. Check the software version to make sure it is the same as on the USB memory stick. See MAZDA CONNECT Software Version Verification Procedure.

36. Press the three buttons (Music (A) + Favorites (B) + Volume Mute(C)) on the commander switch at the same time for 2-5 seconds to open the Diagnostics Test screen again.

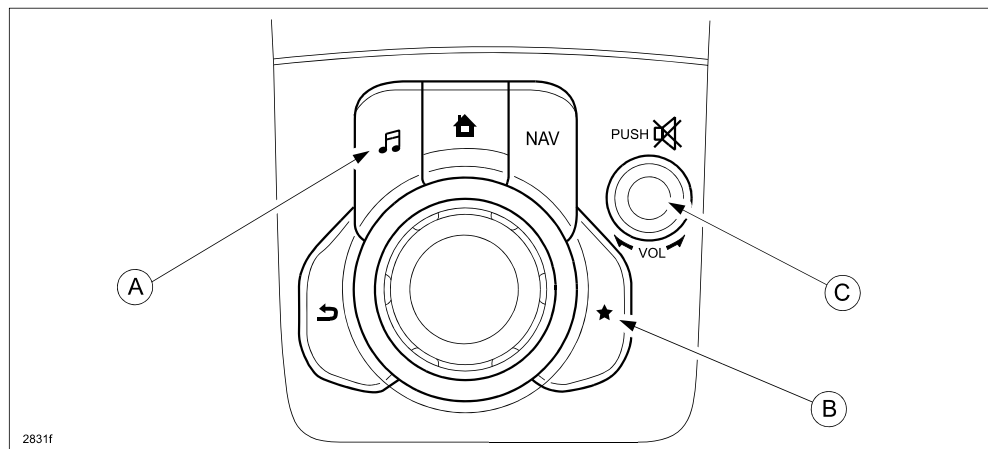

37. On the test screen, input '3' and then select "ENTER" to verify whether any DTCs (in the CMU) are active. Select "EXIT" to go to next step. If any DTC are present, diagnose it following to the Workshop Manual.

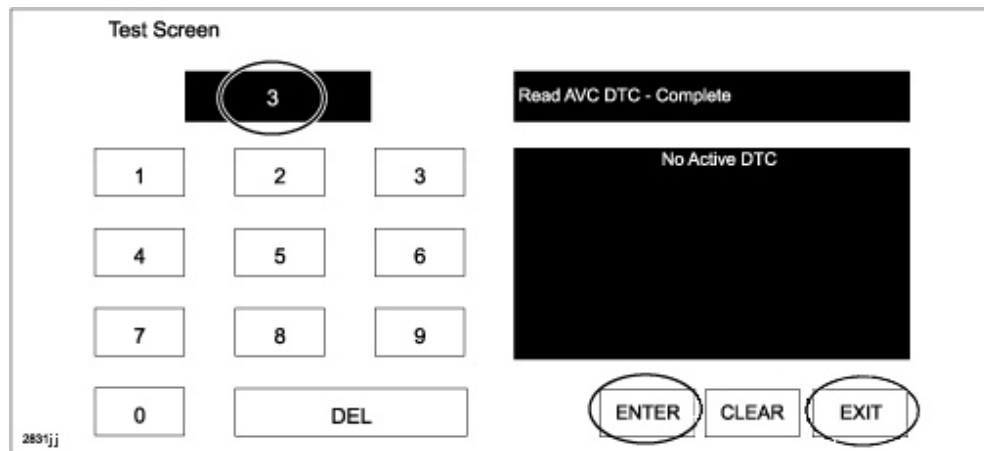

38. Turn the ignition switch OFF, then remove the USB memory stick from the USB port.
- NOTE:** Before attempting to re-pair a phone to the system, delete MAZDA from the list of Bluetooth devices on any phone that is paired with the system. If not deleted, the phone will not be able to be paired with the system because the phone will think it is already paired.
39. Disconnect the battery charger from the vehicle.
40. Insert the SD card into the slot.
41. Turn the ignition switch ON.
42. Go to NAV screen and confirm current vehicle location is correctly displayed.
- If it is not correct, drive the vehicle at a speed of 15 km/h (10 mph) or faster until the correct location is shown.
43. Set the customer's radio favorites (AM/FM/XM).
44. Verify repair.

WARRANTY INFORMATION

NOTE:

- This warranty information applies only to verified customer complaints on vehicles eligible for warranty repair.
- This repair will be covered under Mazda's New Vehicle Limited Warranty term.
- Additional diagnostic time cannot be claimed for this repair.
- For Mazda3, check the SSP98 status first.
 - If SSP98 is OPEN, submit the claim using SSP98 warranty information.
 - If SSP98 is CLOSED, submit the claim using this TSB warranty information.
 - If vehicle is NOT SUBJECT to SSP98, submit the claim using this TSB warranty information.

Warranty Type	A
Symptom Code	61
Damage Code	9W
Part Number Main Cause	5555-RP-CMU
Quantity	0
Operation Number / Labor Hours:	XX567AFX / 0.3 Hrs.