

Date	Group	No.	Release	Page
9.2016	284	871	01	1(7)

Engine Control Module (ECM), Software
Updates
MP7, MP8, MP10
CHU, CXU, GU, TD, MRU, LEU, LR

PI0871, Engine Control Module (ECM), Software Updates

(September 2016)

Information

Software updates with enhancements are available for the Engine Control Module (ECM) for MACK MP7, MP8, and MP10 engines with US2016 emission level on vehicles built from January 4, 2016 to May 6, 2016. Software updates address the following.

- Campaign needed to update trucks shipped to California for inducement strategy on meeting CARB Regulations, and implement Selective Catalytic Reduction (SCR) inducement (5mph) for NOx conversion.

Note: This bulletin does not apply to MACK Trucks Australia.

Required Tools

Premium Tech Tool (PTT) version 2.05.23 or higher

Vocom Diagnostic Connector 88890304

Communication Interface 88890300

Note: Using other interfaces may affect programming speed.

Note: Check Premium Tech Tool version by clicking on Help tab and then click on "About Tech Tool".

Software Update Procedure

You must read and understand the precautions and guidelines in Service Information, group 20, "General Safety Practices, Engines" before performing this procedure. If you are not properly trained and certified in this procedure, ask your supervisor for training before you perform it.

DANGER

Do not attempt to repair or service this vehicle without having sufficient training, the correct service literature and the proper tools. Failure to follow this could make the vehicle unsafe and lead to serious personal injury or death.

- 1 Park the vehicle on a level surface.
- 2 Apply the parking brake.
- 3 Place the transmission in neutral or park.
- 4 Install the wheel chocks.

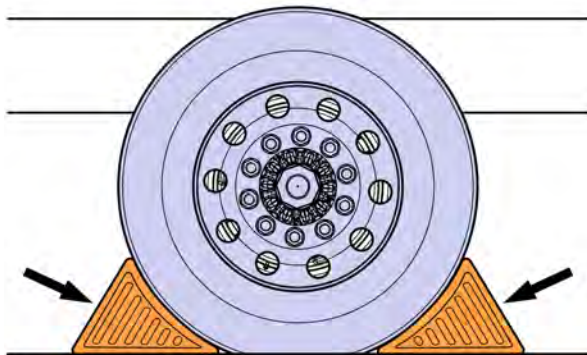

W7086748

- 5 Verify service program eligibility by checking service program status in VDA.
- 6 Connect Premium Tech Tool (PTT) to the vehicle diagnostics connector using the 16 pin OBD cable 88890304 and Communication Interface 88890300. Connect the PC to a functional LAN or modem connection and a 120 Volt AC source.

- 7 Turn the ignition switch “ON”.
- 8 Log in to PTT and Identify Vehicle is displayed.
- 9 Once the vehicle has been identified, enter the Work Order Number information, then click Start Work.

Work Order Number

Enter a work order number or select a recently used work order number in the list.

Enter work order number:

Select a recently used work order:

Work Order No	User ID	Date
---------------	---------	------

Enter Notes:

Start Work Cancel

W2115477

- 10 From the Main Menu select Program and **then** Program Electronic Control Unit 1700-08-03-39. Then click Start.

Tech Tool

Tech Tool Links Help

Product Product History Diagnose Test Calibrate Program Impact

Program

Select an operation and click Start

- 1700-08-03-39 Program Electronic Control Unit
- 1700-22-03-03 Parameter, programming
- 1700-22-03-28 Accessory Kit
- 1700-22-03-12 Replace Electronic Control Unit
- 1700-22-03-13 Program with Stored Software
- 1700-08-03-40 Handle Component
- 2841-22-03-04 Create Engine Label
- 3810-22-03-10 Change Language

W2115478

11 Select **EMS**.

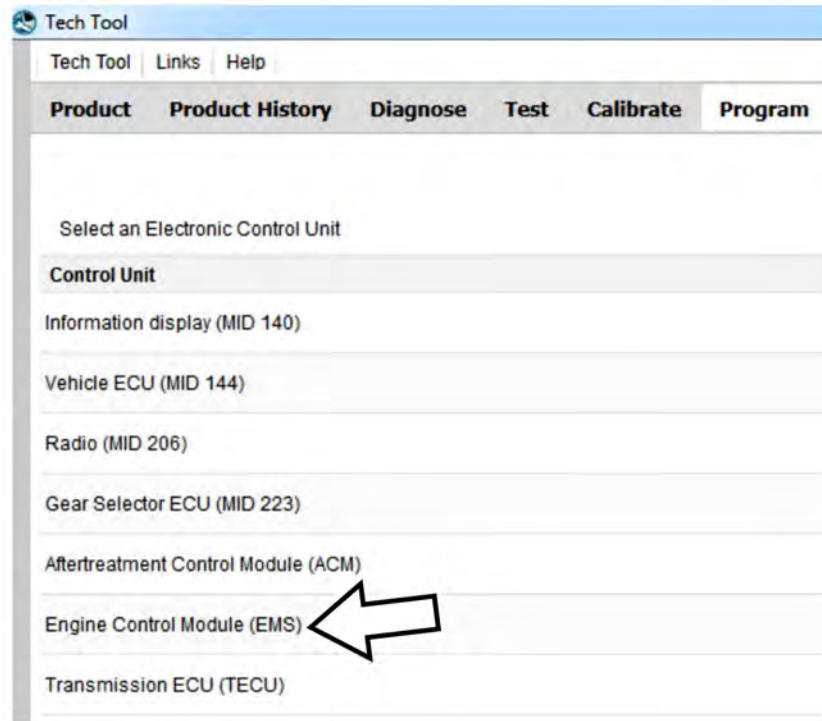

W2115479











12 Select Program to update the **EMS** with the latest software.

Programming options

- Update control unit with latest software
- Reload control unit with existing software

W2115480

13 Certain conditions must be met to continue with programming: battery voltage above 10v, parking brake applied, and ignition key in ON position with engine not running. When all conditions have been met, click Continue to proceed with programming.

1	 > 10 V	12.7 V	
2	  		
3	  = 0 rpm	 0 rpm	

1700-08-03-39 Program control unit - Update software

Automatically checked conditions

- 1 Battery voltage above 10 V
- 2 Parking brake applied
- 3 Ignition key in ON position. Engine not running

W2115481

14 Select "I accept" to agree to the terms and press continue to proceed.

Note: In the United States and Canada, the programming is NOT chargeable. An invoice will not be generated.

1700-08-03-39 Program control unit - Update software

The following control units will be programmed

Engine Control Module (EMS)

Chargeable programming

The software you are about to program is chargeable. If programming is performed using the software, an invoice will be generated.

Programming will be charged once even if multiple retries are needed.

The software has commercial part number

85136079 : Engine Control Module

The number can be used for price lookup in your local system and will be specified on the invoice.

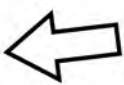
I accept 

Select I accept to agree to the terms Press Continue to proceed

W2115482

15 If the software is already updated, this screen opens. Select Yes to reload existing software.

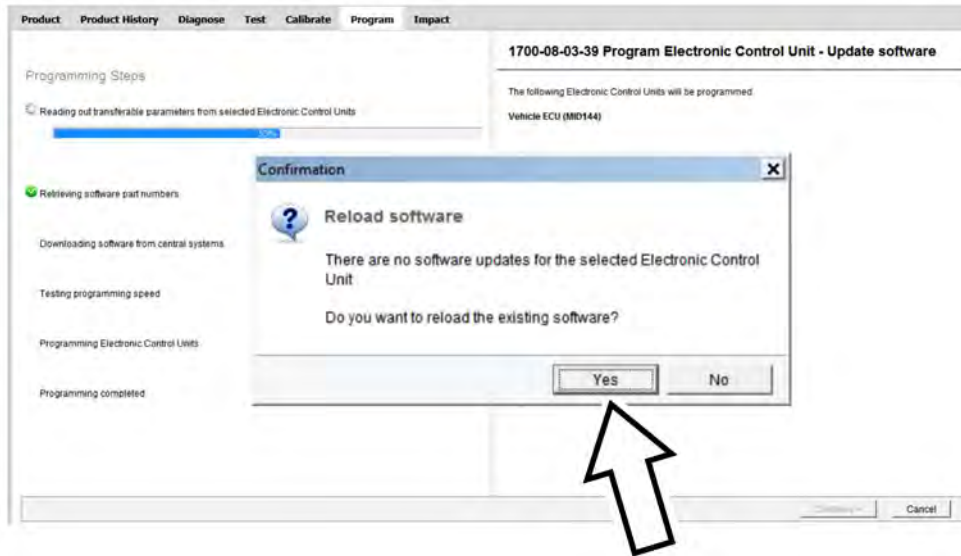

W2115483

16 When the programming is complete, clear any diagnostic trouble codes (DTC) and Finish Work.

17 Remove the wheel chocks.

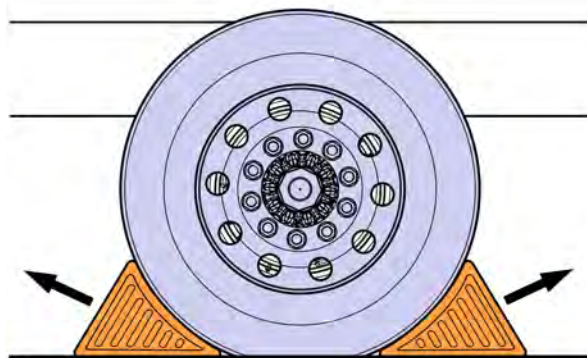

W7086759

Reimbursement

This repair is covered by an authorized Service Program. Reimbursement is obtained via the normal claim handling process.	UCHP Reimbursement
Recall Status	
Vehicle inspected, repair not required	1- Inspected OK
Vehicle repaired per instruction	2- Modified per instruction
Labor Code	
Primary Labor Code	2841-22-09-12 0.3 hrs
Time to take charge and determine campaign status	1700-16-01-01 0.3 hrs
Causal Part	3092091
Parts Disposition	N/A
SCC Code	S7111
Authorization Number	N/A
Expiration Date	31 - DEC - 2016

Note: Take Charge Time is not included in the Labor Code for this operation. Take charge may be eligible but can only be used once per repair visit. If vehicle is having other warranty repairs performed, take charge should be charged to the warranty repair, otherwise take charge can be charged to this service program.