



Technical Journal

TITLE:

XC90 Sunroof Cassette Rear Leak

REF NO: TJ 31272	ISSUING DEPARTMENT: Technical Service	CAR MARKET: United States and Canada	
PARTNER: 3 US 7510 Volvo Car USA		ISSUE DATE: 2016-04-11	STATUS DATE: 2016-04-18
FUNC GROUP: 8364	FUNC DESC: Sun visor, roof hatch	Page 1 of 10	

“Right first time in Time”

Attachment

File Name	File Size
TJ 31272.pdf	2.3573 MB

Vehicle Type

Type	Eng	Eng Desc	Sales	Body	Gear	Steer	Model Year	Plant	Chassis range	Struc Week Range
256							2016-2016		0000561-0085430	201507-201612

CSC Customer Symptom Codes

Code	Description
K3	Sun/moon/convertible roof/Water leakage

VST Operation Number

VST Operation Number	Description
98627-2	Sun roof adjust

DTC Diagnostic Trouble Codes



Text

DESCRIPTION:

If customer complaints of water leakage, and the diagnose shows that it is coming from the rear sunroof cassette, please follow advice under **SERVICE**.

SERVICE:

If the diagnose shows water leakage from the rear sunroof cassette, please follow the attached service instruction.

Please note when ordering part number 893092 Instant adhesive in the Chemical Portal you need to look for 0893092 due to system error in the instruction tool.

VEHICLE REPORT:

Yes, please submit a Vehicle Report if the service solution described in this TJ has no effect. Use concern area "Vehicle Report" and sub concern area "Support not needed", use function group 8364.

To view TJ attachment continue to next page. This TJ has one attachment.



Volvo Car Customer Service

TJ 31272

Title	Sun roof	Page	1 (8)
Action	Product fix	Operation number:	98627-2

Affected vehicles

Model year	Model
2016	XC90 (16-)

Materials

Materials	Qty.	Part No.	Notes
Cleaning agent	0.2	9192678	
Weatherstrip	1.0	31651412	
Instant adhesive	0.1	0893092	See Chemical Portal;

Orientation view

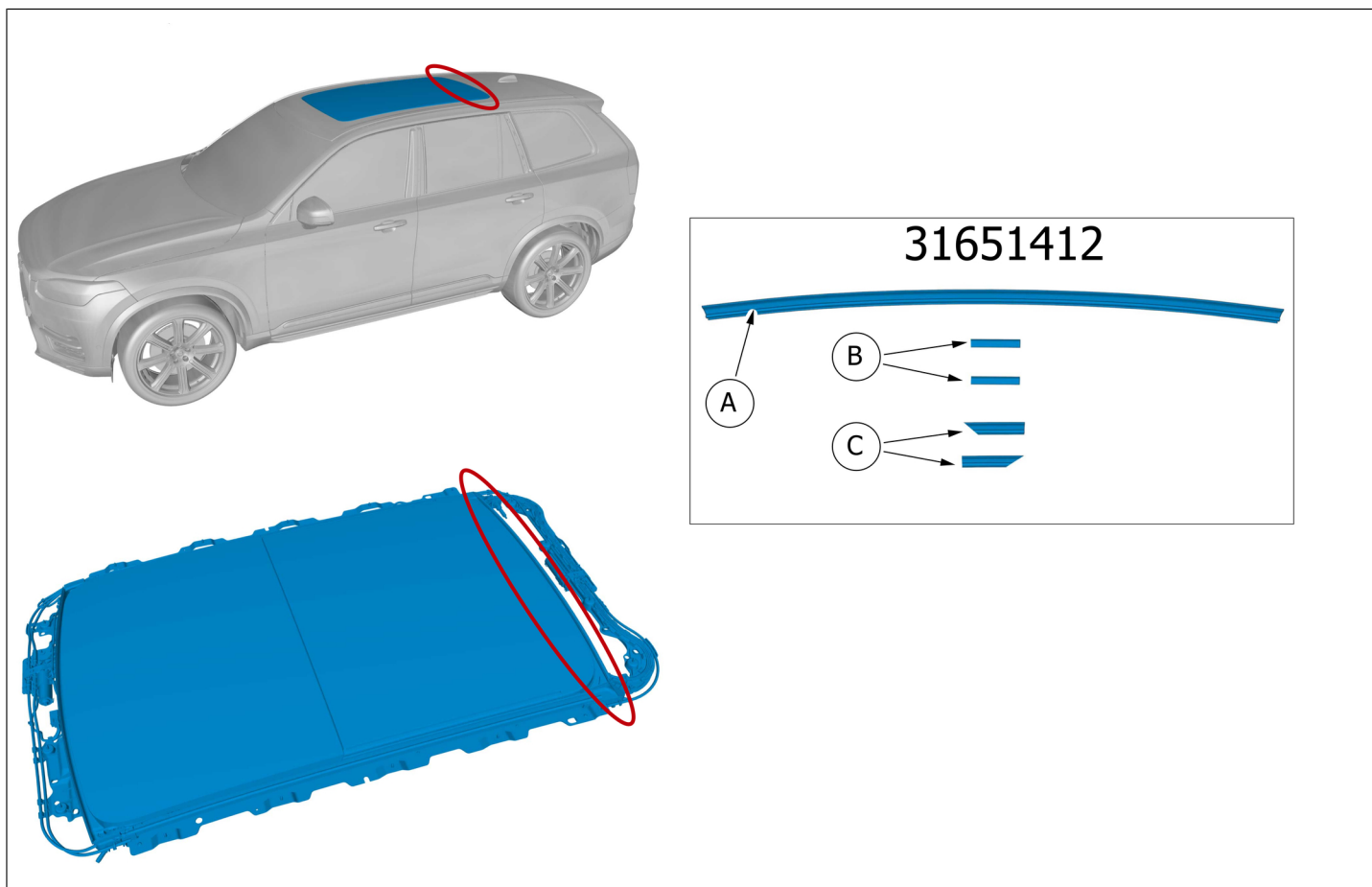
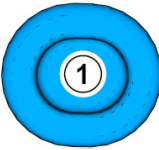
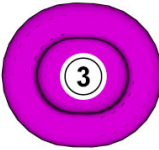
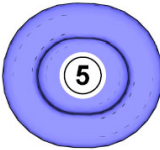
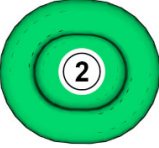
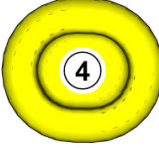
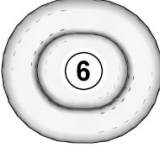
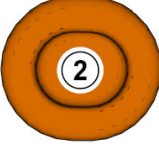
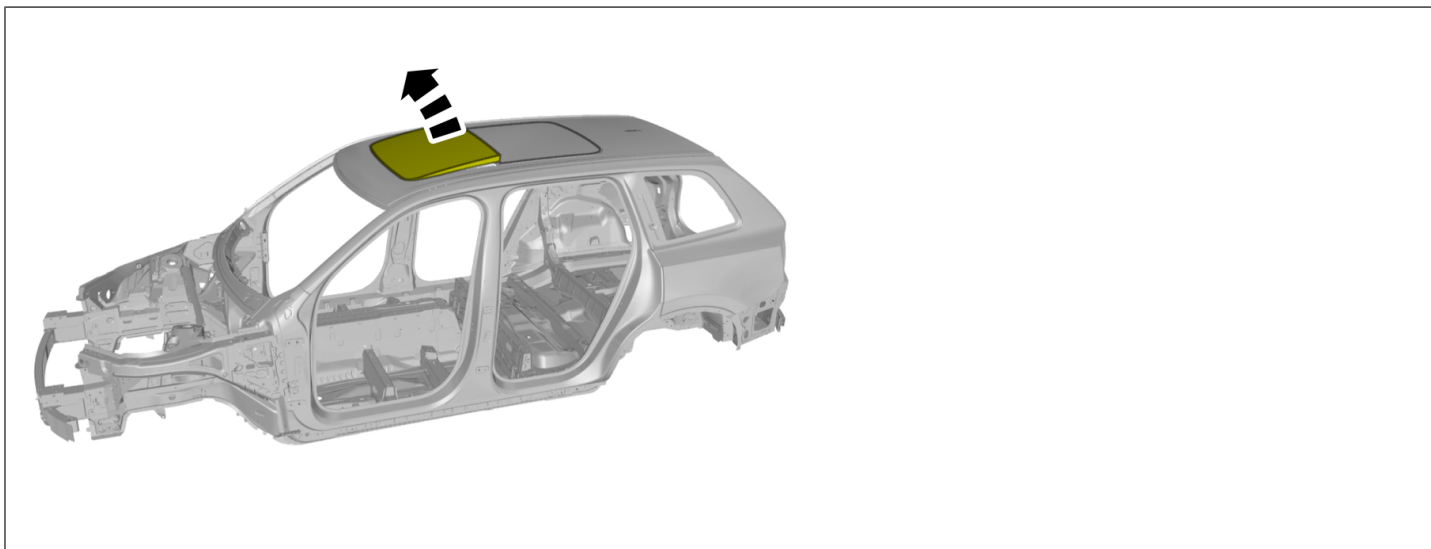

Image philosophy

			<ol style="list-style-type: none"> 1 . Used for focused component, the component with which you will do something. 2 . Used as extra colors when you need to show or differentiate additional parts. 3 . Used for attachments that are to be removed/installed. May be screws, clips, connectors, etc. 4 . Used when the component is not fully removed from the vehicle but only hung to the side. 5 . Used for standard tools and special tools. 6 . Used as background color for vehicle components.
			
			

Removal

Remove the headlining , refer to:
Removal, replacement and installation
8 - Body and interior
85 - Interior
855 - other upholstery



On both sides.

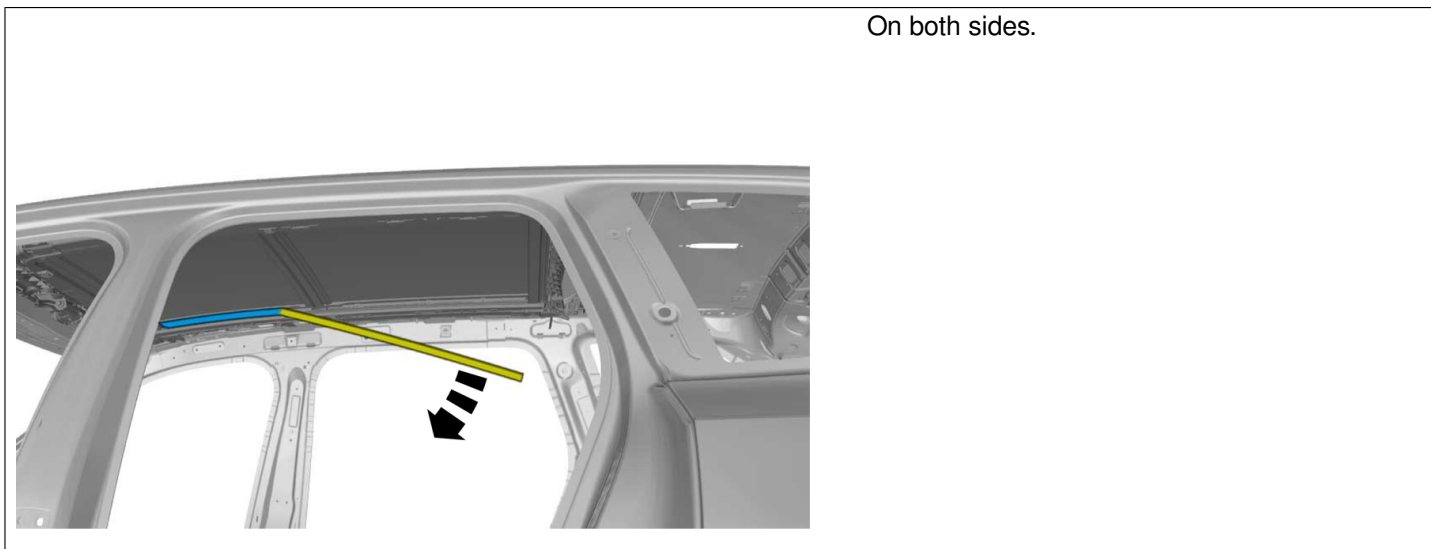

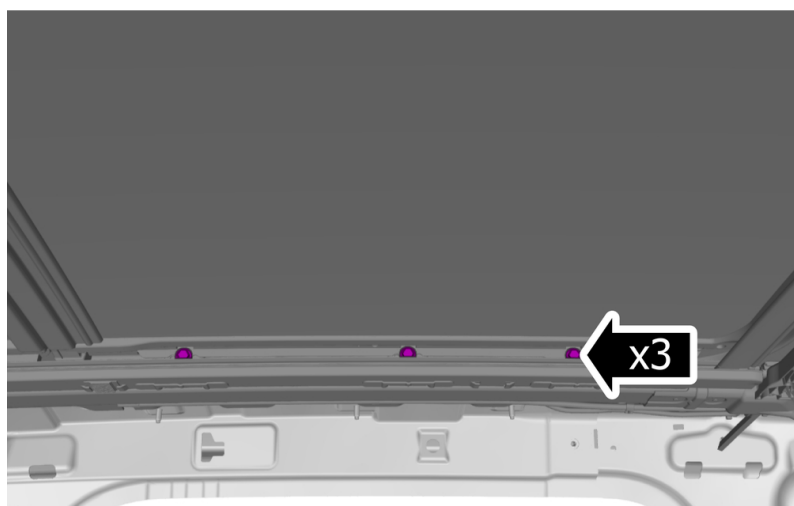

On both sides.
Remove the screws.

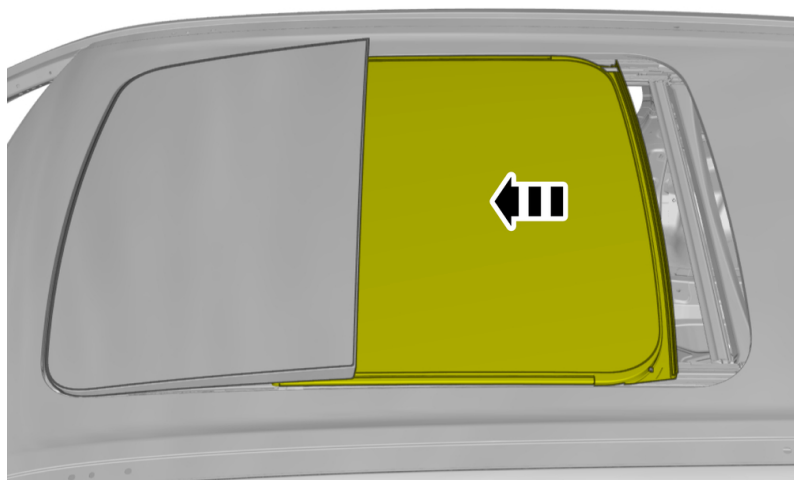

Lift the marked component forward.

Remove the roof hatch extended complete ,
refer to:

- Removal, replacement and installation
- 8 - Body and interior
- 83 - Doors and lids
- 836 - roof hatch

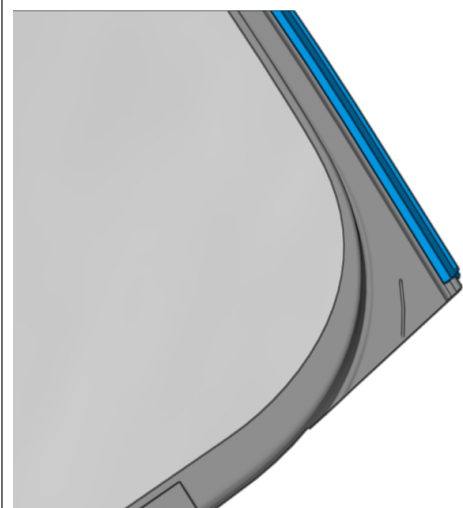

On both sides.
Remove the marked part.

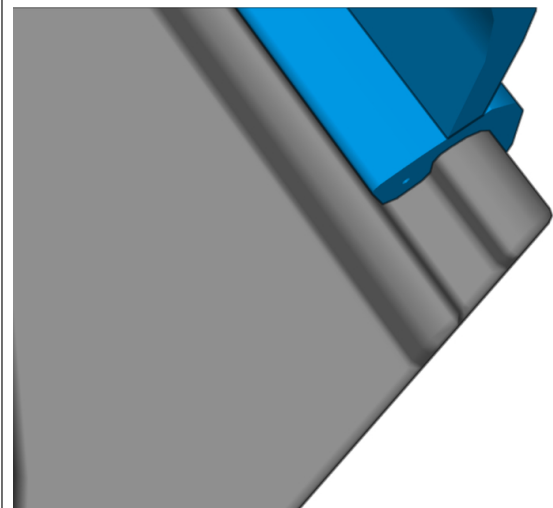

On both sides.

Installation

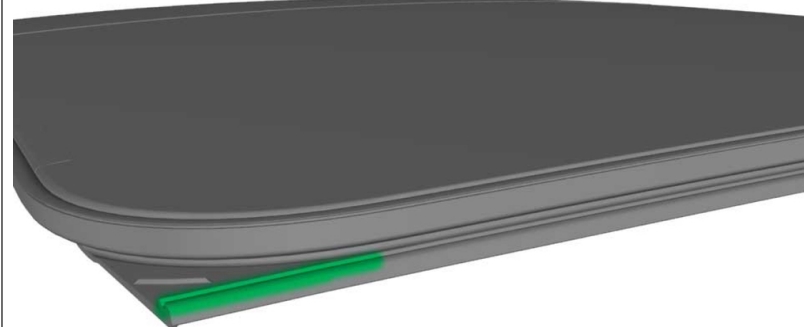

On both sides.

Use: Cleaning agent , 9192678

Install the marked component.

Use: Weatherstrip , 31651412

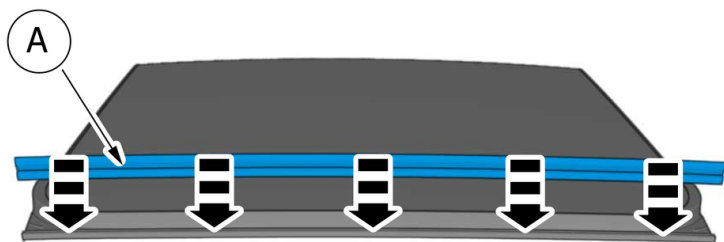

On both sides.

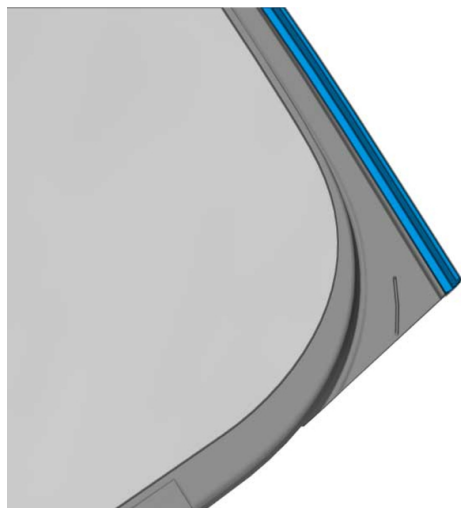

On both sides.

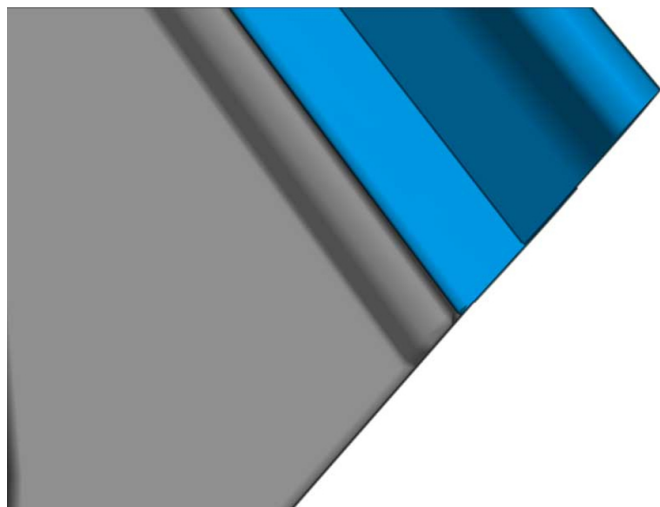

On both sides.

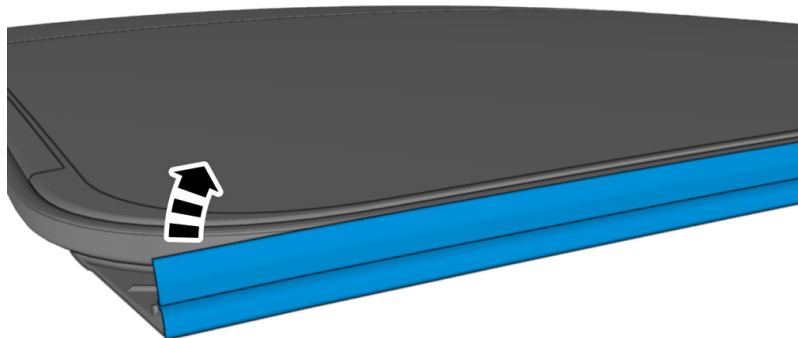

On both sides.

Use: Instant adhesive , 0893092

mm

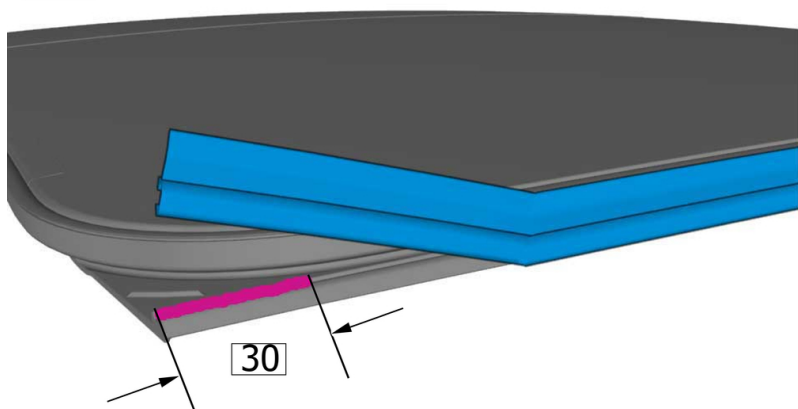

On both sides.

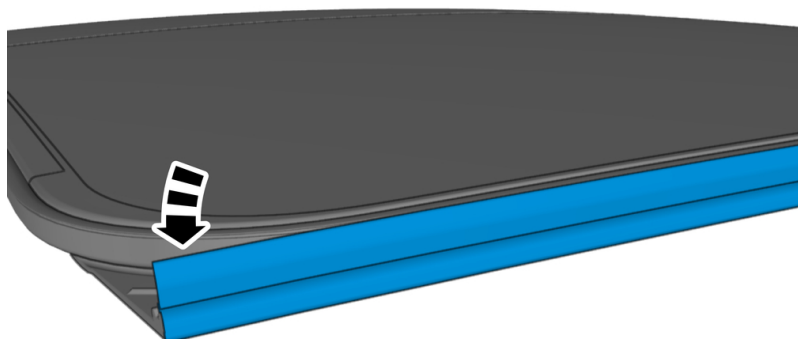

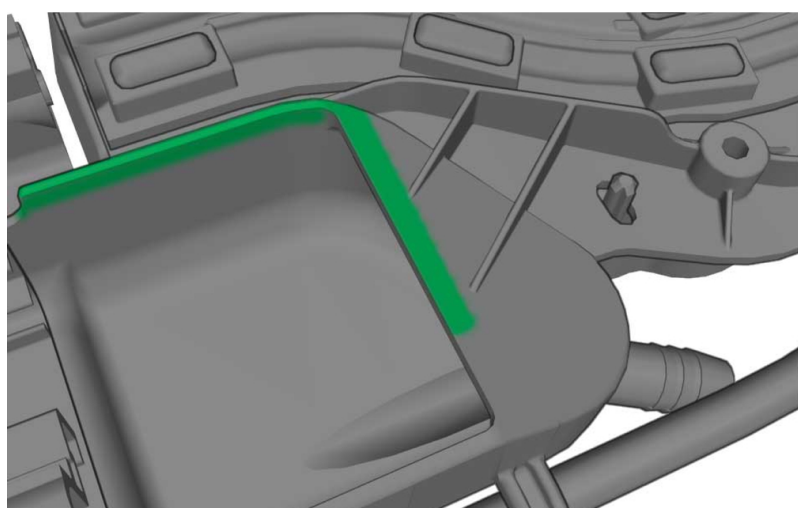

Note: Sunroof cassette needs to be lowered for this next step.

On both sides.

Use: Cleaning agent , 9192678

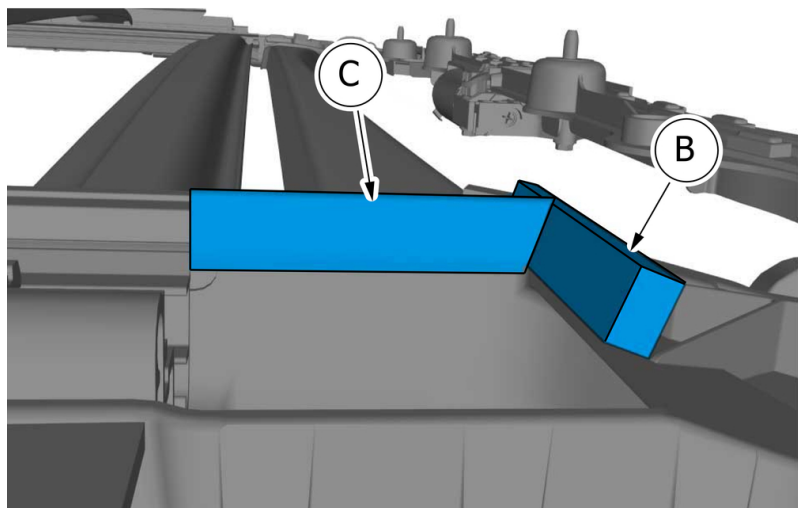

On both sides.

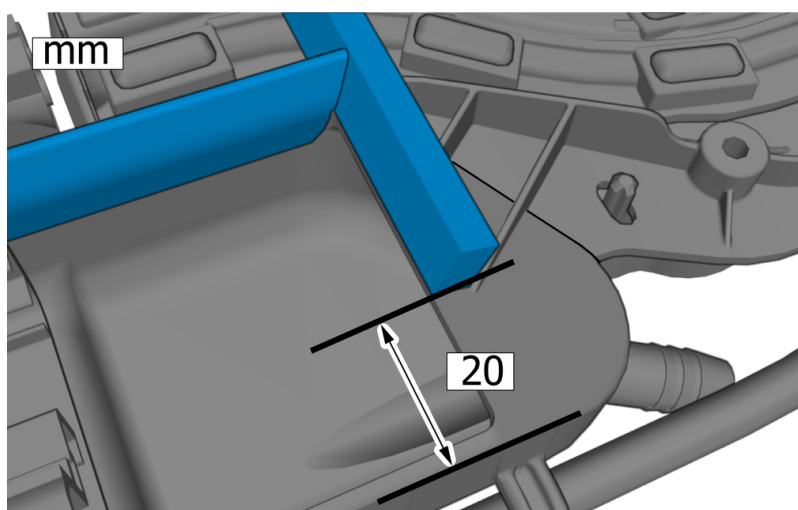

On both sides.

Install the marked component.

To install, reverse the removal procedure.