



Innovation that excites

QUALITY ACTION

CAMPAIGN BULLETIN

2G Telematics Hardware Replacement Customer Satisfaction Initiative

Reference: PC449, PC450
Date: November 17, 2016

Attention: Dealer Principal, Sales, Service & Parts Managers

Affected Models/Years:	Affected Population:	Dealer Inventory:	SERVICE COMM Activation date:	Stop Sale In Effect
2011-14 LEAF	NA	NA	November 16, 2016	NO
2015 LEAF				

***** Customer Satisfaction Initiative Summary *****

On February 26, 2016 Nissan announced that it was sending a reminder notification to owners affected by AT&T's planned discontinuation of the 2G cellular network. At this time, Nissan is beginning the process of making 3G compatible hardware available to owners of affected vehicles as identified above. This upgrade may require an owner to make a co-payment in order to receive the 3G hardware update. Please refer to the chart provided on page 2 to determine if an owner co-pay is required. This customer satisfaction initiative will cover some or all of the parts and labor cost required to upgrade the vehicle's telematics hardware to be 3G compatible.

Note: Vehicle eligibility will be viewed on the second page of Service Comm. This activity is not displayed on the main page of Service Comm because it is optional for customers to participate.

```

                S E R V I C E - C O M M
                SERVICE BULLETINS                                CICSWB06
PRIMARY DATA   NMC MODEL:
LEAF ELECTRIC  AUTOMATIC EMISSIONS CERTIFICATION: 50 STAT
MANUFACTURE DATE: 09/25/13  PLANT: SMYRNA, TN.
-----
----REF----- --POSTED-- -----DESCRIPTION-----
PC449          2016-10-10  2G TELEMATICS UPDATE TO 3G COMPATIBLE CONTROL UNITS
APPLIED REMARKS:  VEHICLE MUST HAVE NAVIGATION;CHECK REPAIR HISTORY FOR
                  PREVIOUS UPGRADE.UPDATE REQUIRES CUST CO-PAY OF $199
                  NISSANCONNECT EV APP FEATURES WILL REQUIRE TCU UPDATE

```

```

                S E R V I C E - C O M M
                SERVICE BULLETINS                                CICSWB06
PRIMARY DATA   NMC MODEL:                                     VIN:
LEAF ELECTRIC  AUTOMATIC EMISSIONS CERTIFICATION: 50 STAT
MANUFACTURE DATE: 09/25/13  PLANT: SMYRNA, TN.
-----
----REF----- --POSTED-- -----DESCRIPTION-----
PC450          2016-10-10  2G TELEMATICS UPDATE TO 3G COMPATIBLE CONTROL UNITS
APPLIED REMARKS:  VEHICLE MUST HAVE NAVIGATION;CHECK REPAIR HISTORY FOR
                  PREVIOUS UPGRADE.UPDATE REQUIRES CUSTOMER CO-PAY OF $0
                  NISSANCONNECT EV APP FEATURES WILL REQUIRE TCU UPDATE

```

******* What Dealers Should Do *******

1. Verify if vehicles are affected by this customer satisfaction initiative using Service Comm I.D. **PC449 and PC450**, which can be found on the second page.
2. The PC449 and PC450 notice on page 2 of Service Comm is not VIN specific and does not disappear after a vehicle has been upgraded. Service Advisors should verify if the vehicle is still eligible for an upgrade before informing a customer.

NOTE: Vehicles without Navigation are ineligible as they are not equipped with TCUs.

Verify applicability using one of the following methods:

1. Check vehicle service history for previous repair (PC449 or PC450).
2. Check the TCU ID number on the vehicle information screen. If the TCU ID begins with something other than **2012**, it is a 3G TCU and does not require an update. To identify if the vehicle has a 2G or a 3G TCU, complete the following steps on the head unit:
 3. Press the hard button labeled Menu.
 4. Press the "CARWINGS" soft button on the center display screen.
 5. Press the "CARWINGS Settings" soft button on the center display screen.
 6. Select the down arrow on the center display screen.
 7. Press "Unit ID information" soft button on the center display screen.
 8. If TCUID starts with "2012-1" it is a 3G device.
 9. If TCUID starts with "2012-0" it is a 2G device.

NOTE: As indicated above, TCU IDs that begin with something other than 2012 are 3G TCUs and do not require an update.

3. If applicable, dealers should ensure customers are informed of the 3G upgrade option when bringing their vehicle in for service **and that customers understand a co-pay may be involved.**
4. Dealers must obtain customer approval in advance of the upgrade being performed. If a customer approves, update the vehicle using the procedure included with this announcement.

MODEL	MODEL YEAR	CO-PAY AMOUNT	PNC
LEAF	2011-2014	\$199	PC449
	2015	\$0	PC450

- If a customer elects to have a 3G compatible Telematics Control Unit installed, the dealer is responsible for collecting the co-pay from the customer
- Upon completion of the installation of the 3G hardware, dealers will file a warranty claim for the parts and labor
 - Dealers will initially be paid for the full amount of the claim
 - Nissan will subsequently debit the dealers Non Vehicle Account for the amount of the co-pay they collected from the customer
 - Dealers will be able to view debits on their monthly Dealer Claims Status Reports

******* Release Schedule *******

Parts	<ul style="list-style-type: none">• There are three different part numbers required based on production date• 12/1/2012 - 09/30/2015: use part number 283B0-3NF2A• 9/20/2011 - 11/30/2012: use part number 283B0-3NA2A• 11/1/2010 - 09/19/2011: use part number 283B0-3NA1A• Parts are not restricted, please order as needed
Repair	<ul style="list-style-type: none">• There is no TSB for this upgrade• Use the procedure included with this announcement after the FAQ
Owner Notification	Nissan will begin notifying owners of potentially affected vehicles the week of November 28, 2016 via U.S. Mail.

******* Dealer's Responsibility *******

It is the dealer's responsibility to check SERVICE COMM using the appropriate Campaign I.D. for the status on each vehicle falling within the range of this customer satisfaction initiative which for any reason enters the service department. If a VIN subject to this customer satisfaction activity was part of a dealer trade, the letter associated with that VIN should be forwarded to the appropriate dealer for upgrade completion.

NISSAN NORTH AMERICA, INC.
Aftersales DIVISION

Frequently Asked Questions (FAQ):

Q. What is the reason for this customer satisfaction activity?

A. AT&T will discontinue its 2G cellular network coverage on December 31, 2016. Like all cellular-equipped devices designed to connect to the 2G cellular network, Nissan LEAF vehicles with a 2G-compatible telematics control unit (TCU) will be unable to use or receive services from that device after December 31, 2016. Without an upgrade to the TCU (and enrollment), NissanConnect EV App features will not be available after that time and may be impacted prior to that date depending upon AT&T's proprietary decisions regarding discontinuing 2G network coverage. Also AT&T stopped accepting new enrollments on the 2G network on July 1, 2016. If an affected vehicle has not had a hardware upgrade and was not enrolled in NissanConnect EV before June 30, 2016, then it will not have access to the available NissanConnect EV features, including Remote Climate Control and Driving History, until the upgraded hardware has been installed.

Q: What is 2G cellular network access?

A: 2G refers to "2nd Generation" digital cellular telephone technology; it is the name of a specific network that mobile telephone equipment uses to provide connectivity.

Q. Which vehicles have 2G compatible TCUs?

A. All model year 2011-2015 Nissan LEAF (SV and SL trims only) are equipped with a 2G TCU.

Q: What happens if I do not replace the TCU?

A: Once the 2G cellular network is discontinued, the TCU will no longer be able to access the NissanConnect EV features, including Remote Charge Status Check, Remote Climate Control and Driving History, without a hardware upgrade. For new vehicles (MY2015 or older) sold after June 30, 2016, these vehicles will not be able to be enrolled in NissanConnect EV until the hardware has been upgraded to be compatible with the 3G cellular network.

Q: Will the new TCU hardware work with the 4G cellular network?

A: No. The new TCU hardware is designed to connect to the current AT&T 3G cellular network technology.

Q. Why is Nissan using 3G technology rather than 4G?

A. Nissan has studied how to integrate newer technology into your vehicle and developed solutions aimed at delivering a hardware update option with the least inconvenience to owners. The 3G network is supported throughout the U.S. by AT&T. However, Nissan has no control over availability of any cellular network.

Q: How much will the replacement TCU cost?

A. Owners of model years 2011-14 TCU-equipped LEAFs are asked to participate in the cost of the parts and labor to upgrade the TCU. The customer co-pay amount varies by model year and is listed in the chart below. Nissan will cover the balance of the upgrade cost.

MODEL	MODEL YEAR	CO-PAY AMOUNT	PNC
LEAF	2011-2014	\$199	PC449
	2015	\$0	PC450

Q: A customer has a 2G-equipped Nissan LEAF and is enrolled in NissanConnect EV already. Why do they have to pay for a replacement TCU (PC449)?

A: The discontinuation of the 2G cellular network is outside of Nissan's control. The NissanConnect EV subscription agreement states that owners are responsible for any hardware upgrades due to changes in telecommunication systems. However, Nissan offers NissanConnect EV services free of charge, so it is the customer's choice to upgrade if they wish to continue accessing these free services.

Q: Will my vehicle's navigation system feature be affected by the discontinuation of the 2G cellular network?

A: No. If your vehicle is equipped with a Nissan Navigation system, the navigation system is unaffected by the discontinuation of AT&T's 2G cellular network.

Q. What will be the service department action?

A. If an owner elects to upgrade to a 3G compatible TCU and agrees to pay the applicable co-pay, the dealer's service department should install the 3G hardware using the procedure accompanying this announcement (see instructions after FAQ).

Q. How long will the upgrade take?

A. The upgrade will typically take under two (2) hours to complete.

Q. When will vehicle owners be notified?

A. Nissan will begin notifying owners of potentially affected vehicles the week of **November 28, 2016** via U.S. Mail. Owners may contact Nissan Owner Services at 877-664-2738 to verify if their vehicle is affected by this issue.

Q. Are parts readily available?

A. Yes. Dealers can order parts as needed through the normal process; parts are not restricted.

Q. Will a loaner vehicle be provided while the dealer is servicing the vehicle?

A. Please check with your dealer for alternate transportation availability and further details.

Q. Will I have to take my vehicle back to the selling dealer to have this service performed?

A. No, any authorized Nissan LEAF dealer is able to perform this service.
For Consumer Affairs: Please inform us of the dealer where you would like to have the upgrade completed.

Q. Does this issue affect any other Nissan (or Infiniti) models?

A. Model year 2013-15 and select model year 2016 Infiniti M37, M56, JX35, QX56, Q50, Q70, QX60 and QX80 vehicles are also affected.

Q. I did not receive a letter. How can I tell if my vehicle is affected?

- A. Please provide your vehicle identification number (VIN) to the dealer so that the dealer can check if your vehicle is included in this campaign. Owners may also contact Nissan Owner Services at 877-664-2738 to verify if their vehicle is affected by this issue.

Dealer Service Questions:

Q. What does Sirius XM need in order to complete a TCU Swap?

- A. The dealer should have the original (old) IMEI number, VIN, and the new TCU IMEI number available when calling to activate the new TCU. Dealers will also need to have the model, model year, sales country (i.e. USA), and marketing color name of the vehicle available.

Q. Does an owner need to do anything after the TCU is swapped?

- A. Yes, an owner will have to sign into NissanConnect EV in the vehicle once the new TCU is installed if they do not want to provide their ID and password to the dealer.

If the owner has an existing NissanConnect EV account:

1. Press the **Zero Emission button** on the Multifunction Control Panel
2. Select **CARWINGS** and then **CARWINGS Settings** on the center display screen
3. Select **Sign in** on the center display screen and enter the user ID and password
 - If your vehicle's information screen is not pre-populated, the User ID and Password can be obtained from your Nissan Owner Portal (<https://owners.nissanusa.com/nowners/>)
 - Under the Manage Vehicle tab, click the link to obtain your NissanConnect EV PIN and Password
 - Follow these instructions using the provided PIN and Password

If the owner does not have an existing NissanConnect EV account:

1. Create a Nissan Owner Portal account (<https://owners.nissanusa.com/nowners/>)
2. Add your contact information and VIN
3. Agree to the Terms & Conditions
4. Press the Confirm button to obtain the instructions for providing your User ID and Password for the vehicle's information screen
5. Download the NissanConnect EV companion app and log in using your Nissan Owner Portal ID & Password

Q. Is it possible to identify if a vehicle has a 2G or 3G TCU without removing the TCU?

- A. Verify applicability using as follows:
1. Check the TCU ID number on the vehicle information screen. If the TCU ID begins with something other than **2012**, it is a 3G TCU and does not require an update. To identify if the vehicle has a 2G or a 3G TCU, complete the following steps on the head unit:

3. Press the hard button labeled Menu.
4. Press the "CARWINGS" soft button on the center display screen.
5. Press the "CARWINGS Settings" soft button on the center display screen.
6. Select the down arrow on the center display screen.
7. Press "Unit ID information" soft button on the center display screen.
8. If TCUID starts with "2012-1" it is a 3G device.
9. If TCUID starts with "2012-0" it is a 2G device.

NOTE: As indicated above, TCU IDs that begin with something other than 2012 are 3G TCUs and do not require an update.

Q. What if the 2G or 3G TCU part is missing the IMEI (International Mobile Equipment Identity) number that is used to identify the TCU?

- A. The IMEI number can be found on the label adhered to the TCU part. If this label is missing or is not legible, you can use the SIM ID/ICCID instead. The SIM ID/ICCID is located on the head unit "Unit ID" screen, you can locate this screen by following the steps in the question above. You will need to locate this number prior to calling the SiriusXM agent to deactivate the 2G TCU and activate the 3G TCU.

Dealers will also need to have the model, model year, sales country (i.e. USA), marketing color name of the vehicle and VIN available.

Q. Who can I call with Telematics system specific questions?

- A. Contact the Nissan Owner Services call center @ 877-664-2738. The call center is operational between 8AM-12AM EST Monday through Saturday.

Q. Which part should be used?

- A. There are three different part numbers required based on production date
- **12/1/2012 - 09/30/2015:** use part number 283B0-3NF2A
 - **9/20/2011 - 11/30/2012:** use part number 283B0-3NA2A
 - **11/1/2010 - 09/19/2011:** use part number 283B0-3NA1A

Q. May a dealer offer dealer goodwill to cover the cost of an owner's co-pay for this upgrade?

- A. The dealer is responsible for collecting the copay from an owner electing to upgrade to a 3G compatible TCU and may choose to not collect co-pays as service to their customers. Nissan will debit a dealer's non-vehicle account for each claim submitted when a co-pay applies.

Q. Will Nissan cover an owner's co-pay using factory goodwill?

- A. No. Factory goodwill will not cover a co-pay for owner's electing to upgrade to a 3G compatible TCU.

Installation instructions follow

LEAF Telematics Control Unit Replacement

IMPORTANT: Those steps in **RED** below, under Campaign Overview, **MUST** be performed in the order listed for the new TCU to operate correctly.

Campaign Overview:

1. Turn OFF the original TCU using CONSULT-III plus (C-III plus) (page 2).
2. **Save the VIN DATA using C-III plus** (page 7).
3. Remove the original TCU from the vehicle (page 8).
4. **Deactivate (unregister) the original TCU and Activate (register) the replacement TCU by calling LEAF TCU Replacement Support Call Center** (page 11).
5. Install the replacement TCU in the vehicle (page 12).
6. Turn ON the replacement TCU using C-III plus (page 12).
7. **Write the VIN DATA using C-III plus** (page 12).
8. **Sign in to TCU with customer's User ID and Password** (page 14).

SERVICE PROCEDURE

Turn OFF the TCU

1. Connect the C-III plus VI to the vehicle.
2. Set the parking brake.
3. Push the vehicle power switch twice to READY mode.
4. Launch C-III plus on the CONSULT PC.
5. Select **Diagnosis (One System)**.

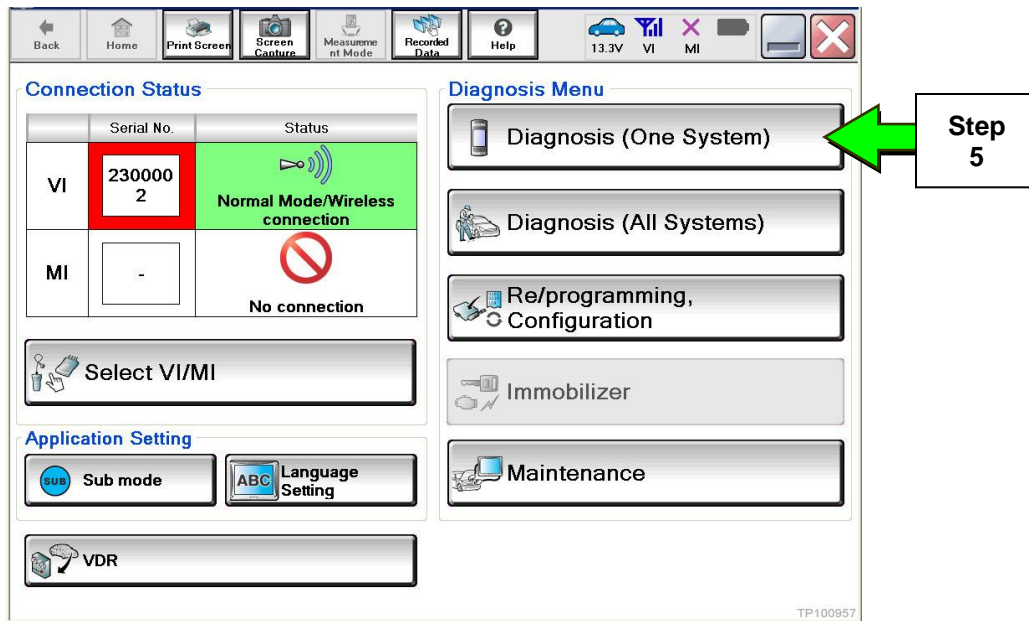

Figure 1

6. Select **TELEMATICS** on page 2 of the all systems list.

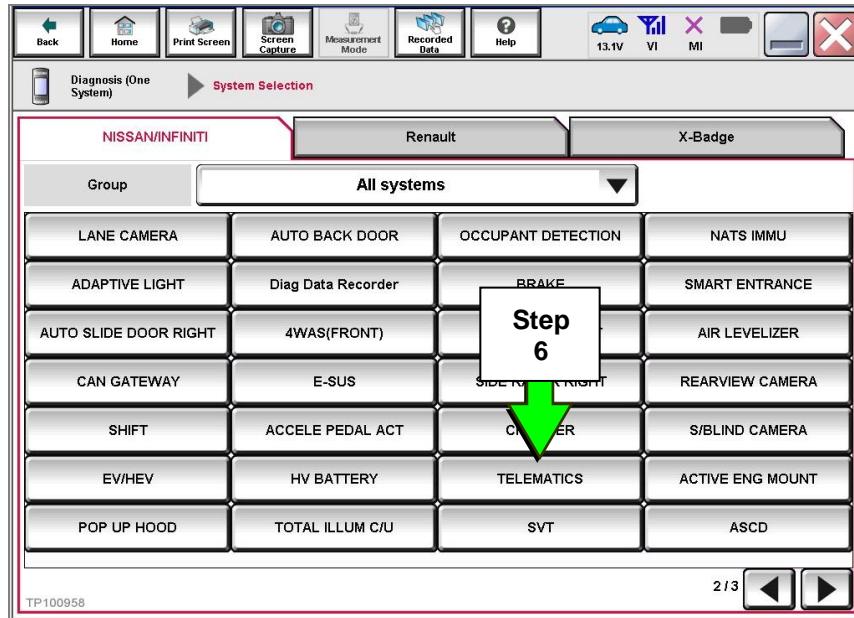

Figure 2

7. Select **Work support**.

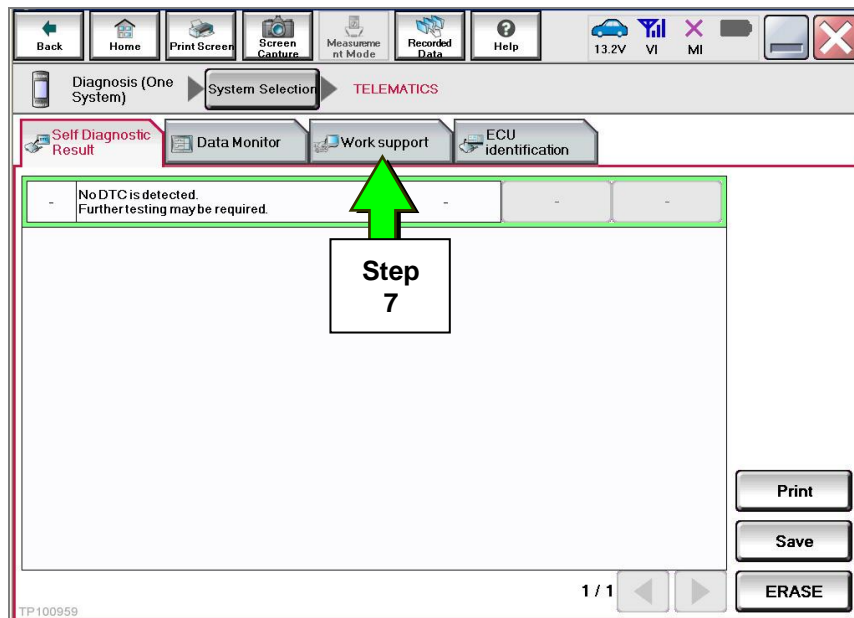

Figure 3

8. Select **TCU ACTIVATE SETTING**.

9. Select **Start**.

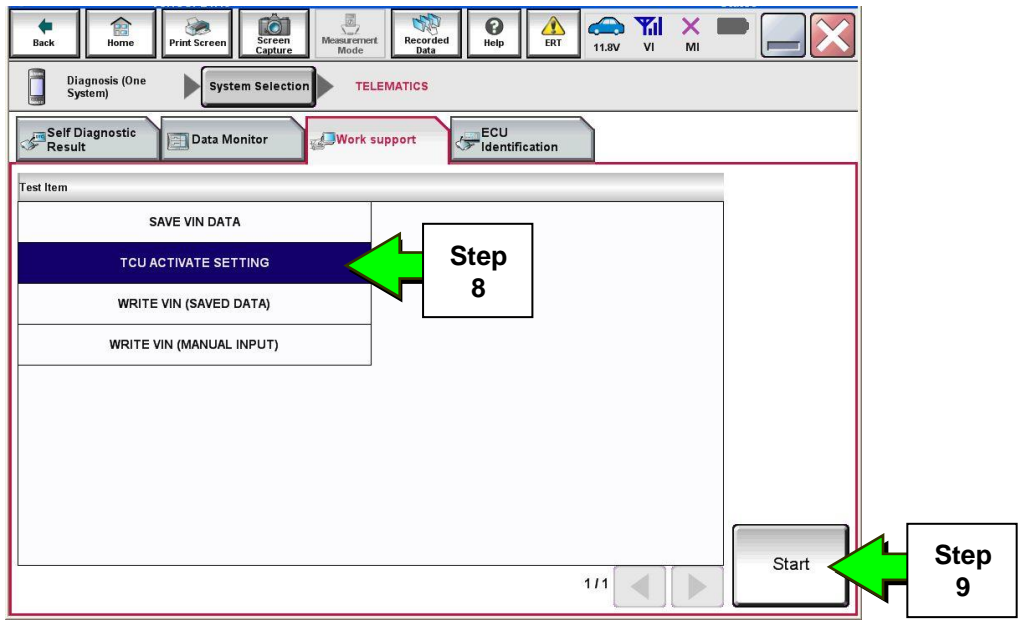

Figure 4

10. Select **Start**.

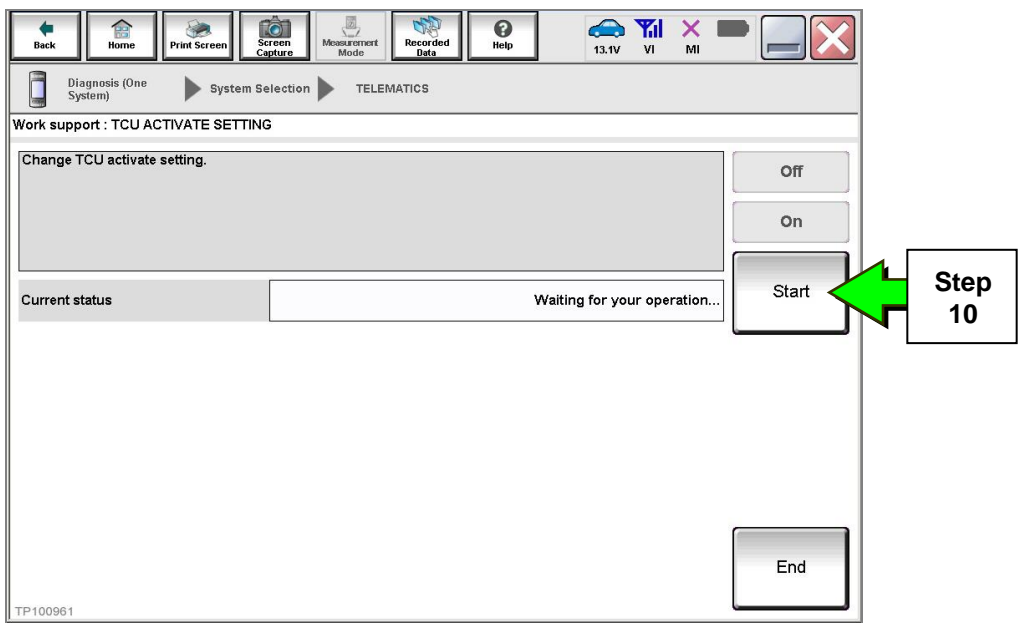

Figure 5

11. Select **Off** to turn OFF the TCU.

12. Select **End**.

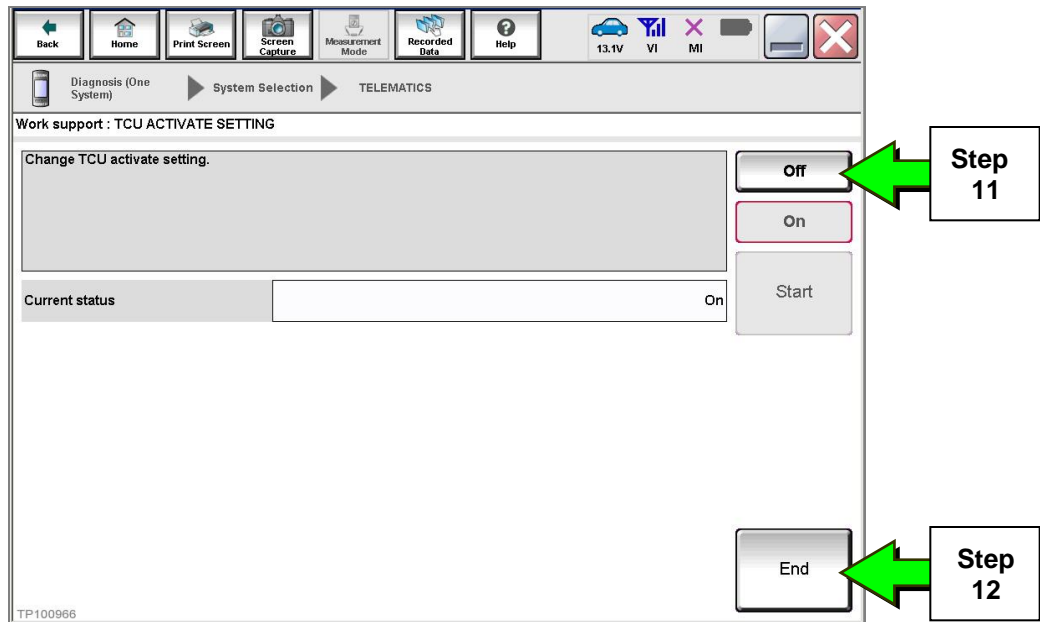

Figure 6

13. Select **Start**.

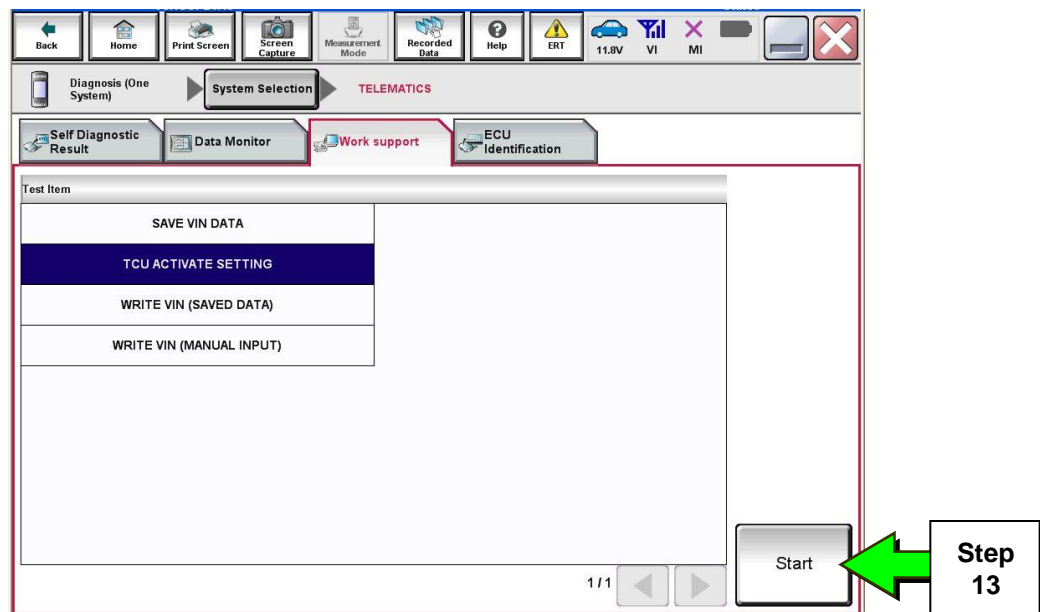

Figure 7

14. Select **Start**.

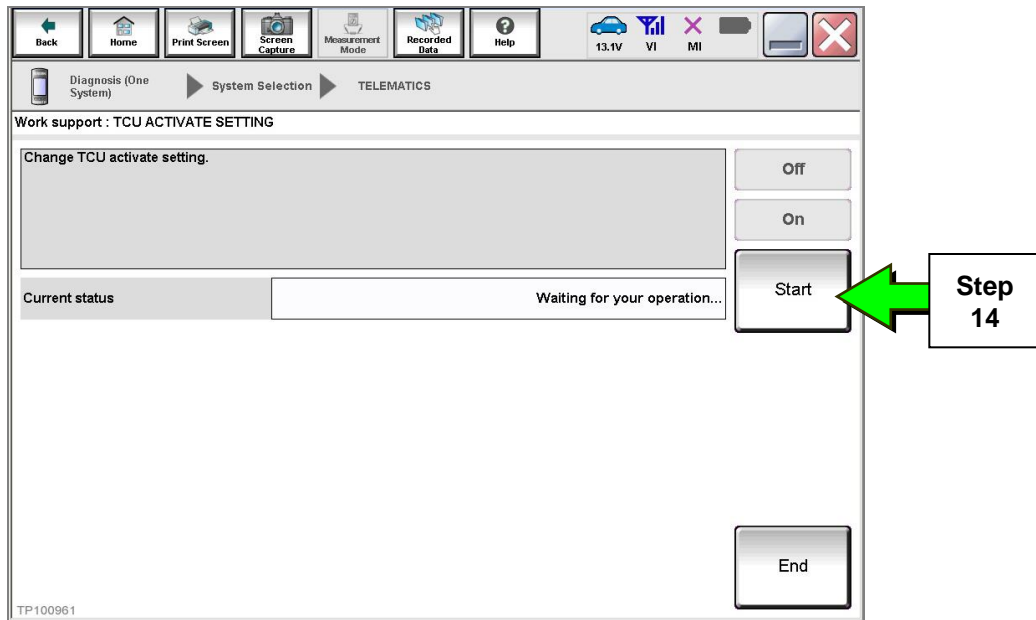

Figure 8

15. Confirm "**Off**" is displayed in the **Current status** field.

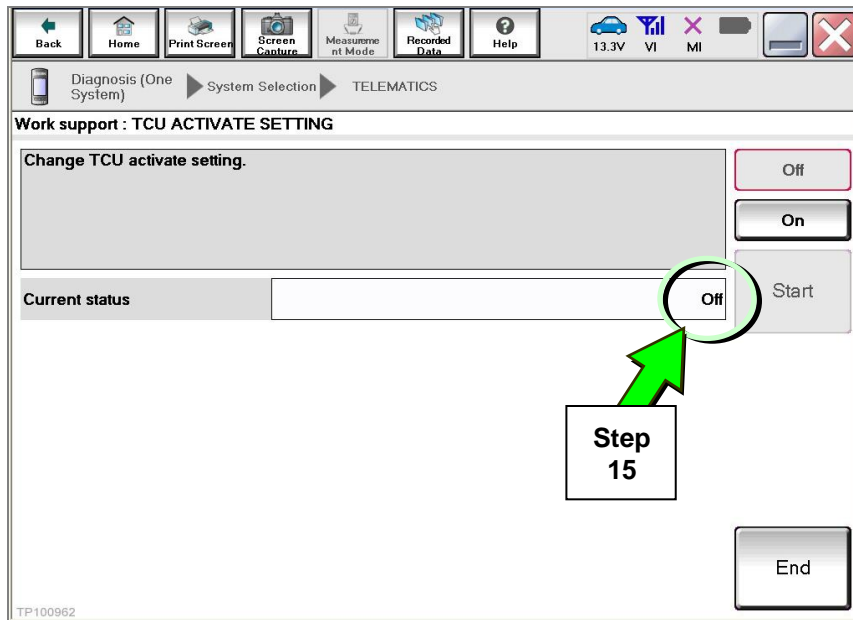

Figure 9

Save VIN Data

1. Select **SAVE VIN DATA**.
2. Select **Start**.

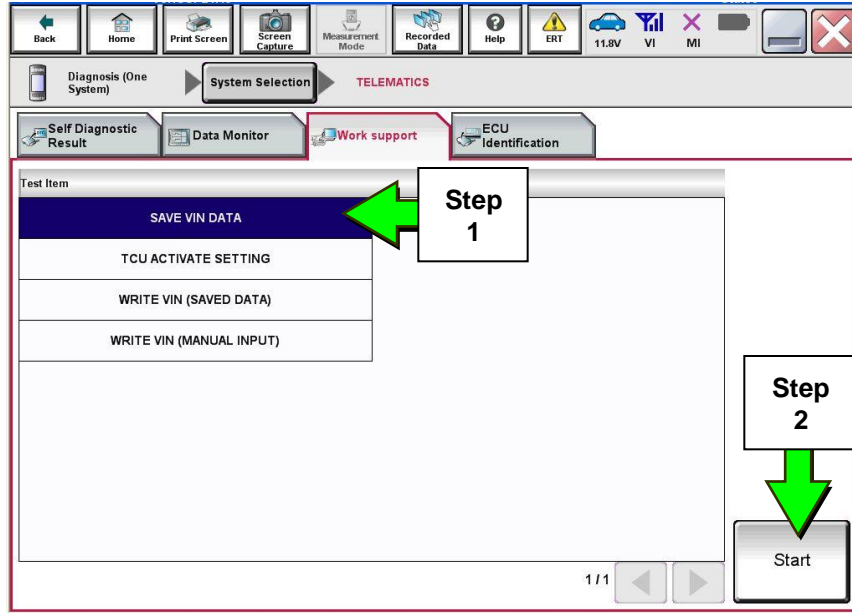

Figure 10

3. Select **Start**.

NOTE: If the VIN data cannot be saved, you will have to manually enter the VIN later in this procedure.

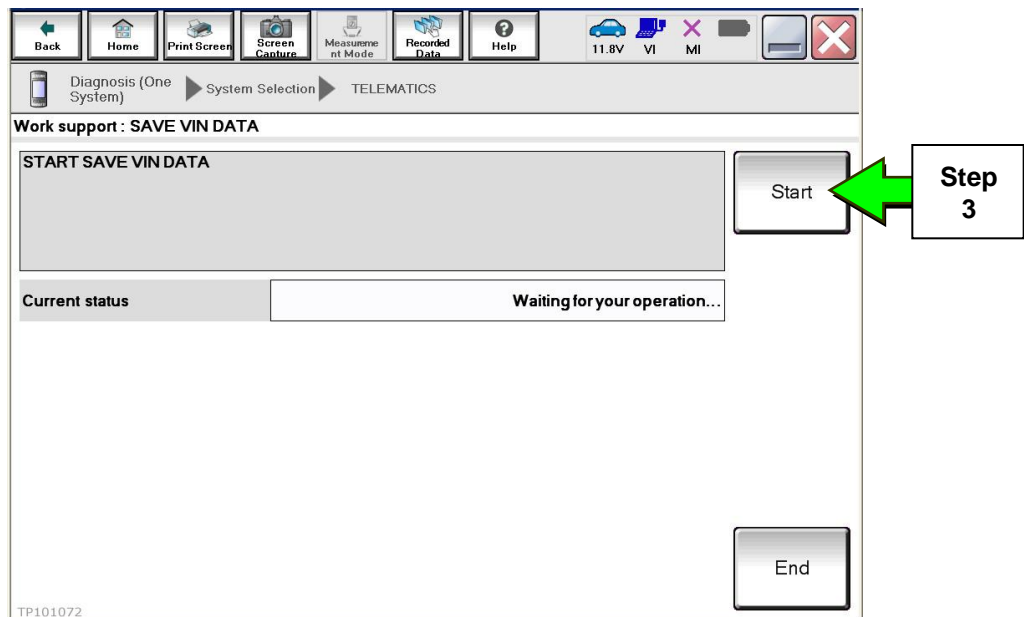

Figure 11

4. Select **End**.

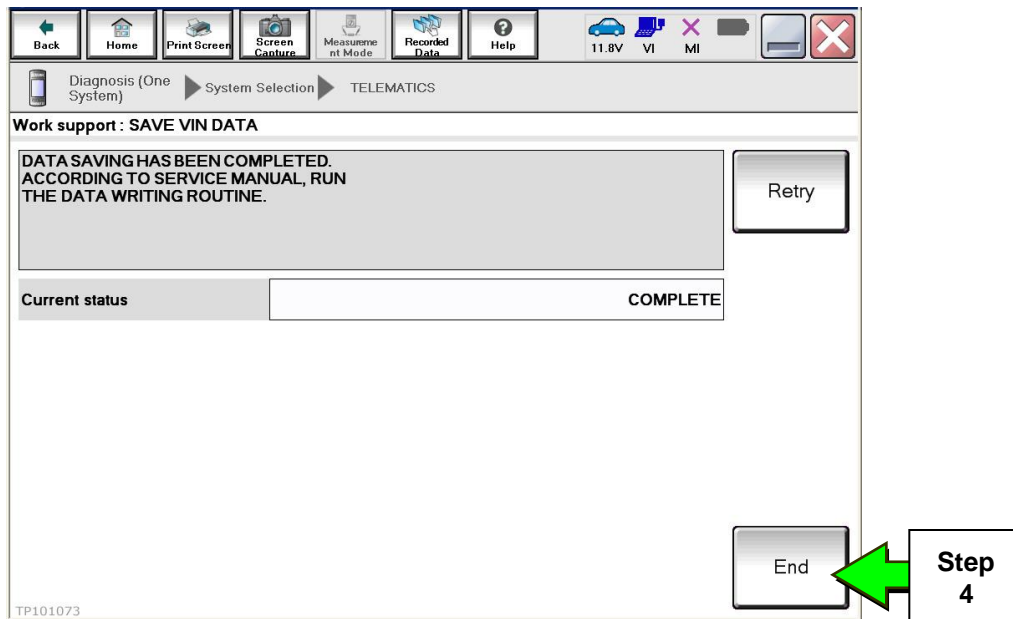

Figure 12

Remove the TCU from the Vehicle

1. Remove glove box lid.
 - a. Open glove box lid.
 - b. Disengage the pawl, then remove damper pin on left side.

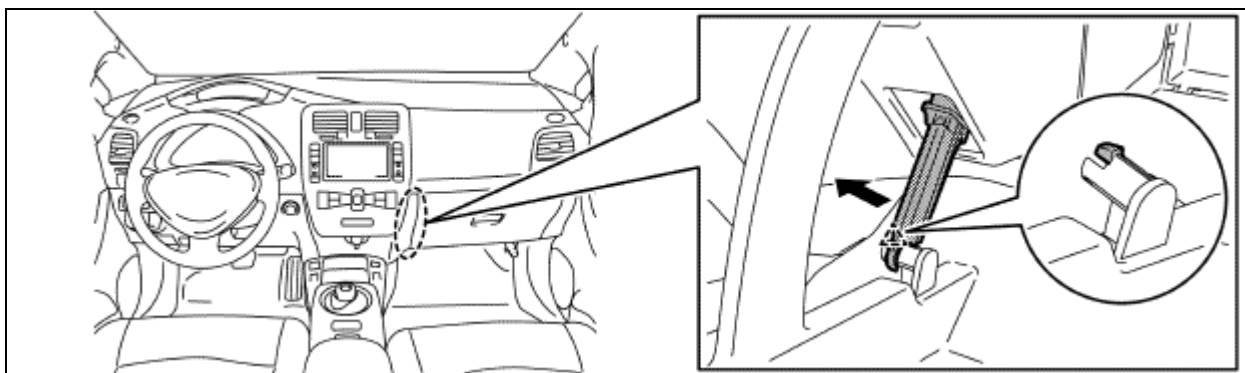

Figure 13

△ : Pawl

CAUTION:
Do not excessively pull string of glove box damper.

2. Pull glove box lid (1) toward vehicle rear, then disengage the joint from glove box cover assembly (2).

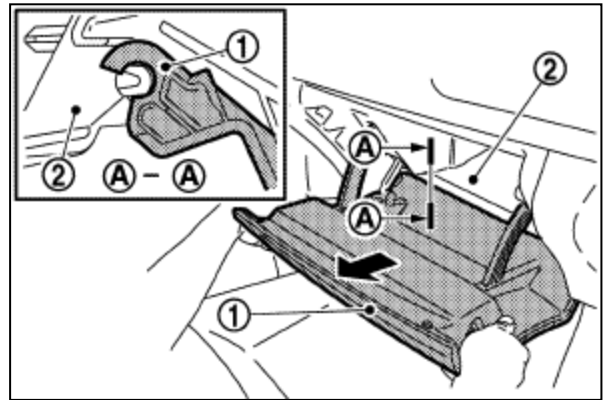

Figure 14

3. Remove glove box cover assembly.
 - a. Remove screws (A).
 - b. Pull back the glove box cover assembly while holding the lower side and disengage the pawl and metal clips according to numerical order 1 → 3 the as shown.

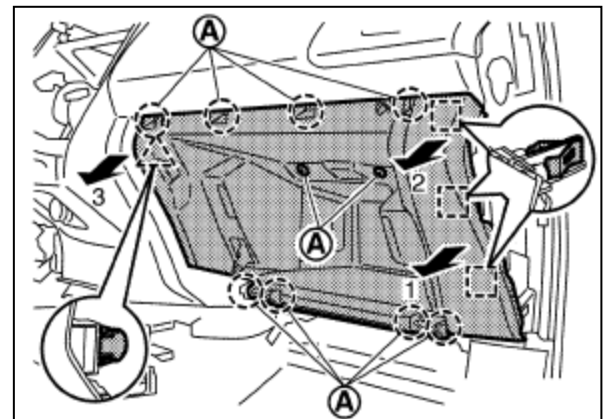
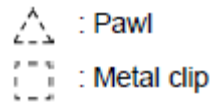

Figure 15

4. Remove the three sheet metal screws (Figure 16) that attach the TCU bracket to the right hand side of the steering member.

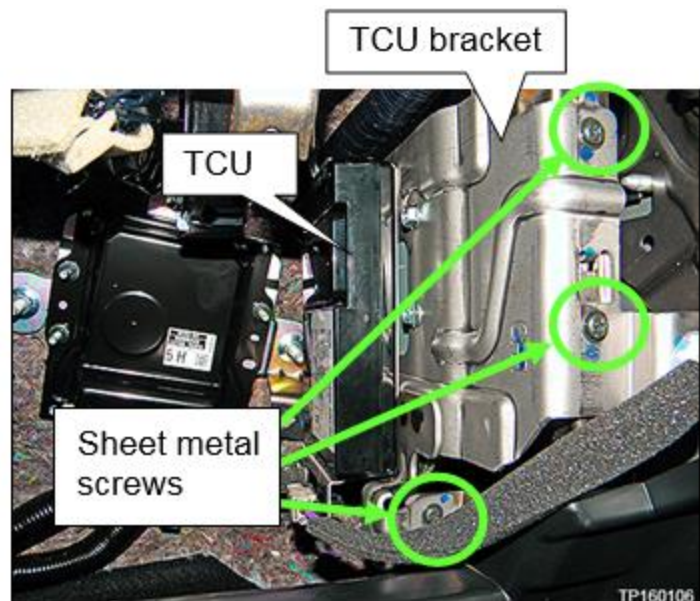

Figure 16

5. Disconnect three harness connectors from the TCU (Figure 17).

NOTE: Leave harnesses attached to bracket.

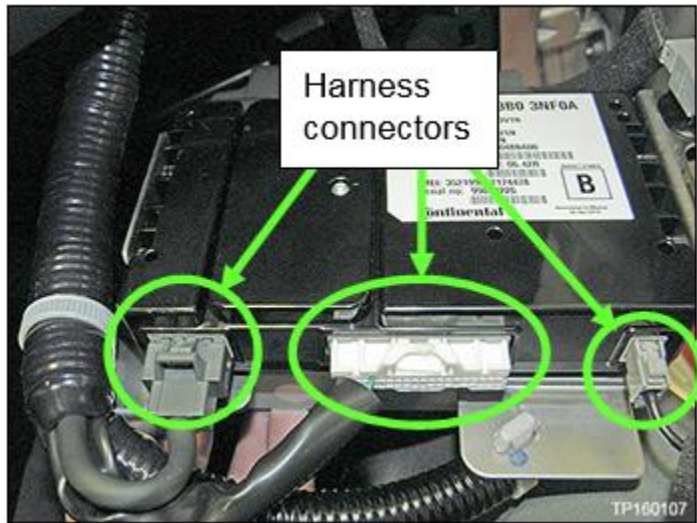

Figure 17

6. Remove the four screws (T20) shown in Figure 18 and Figure 19 (two from each side) that attach the TCU to the mounting bracket and remove TCU from bracket.

NOTE: Do not install the new TCU yet.

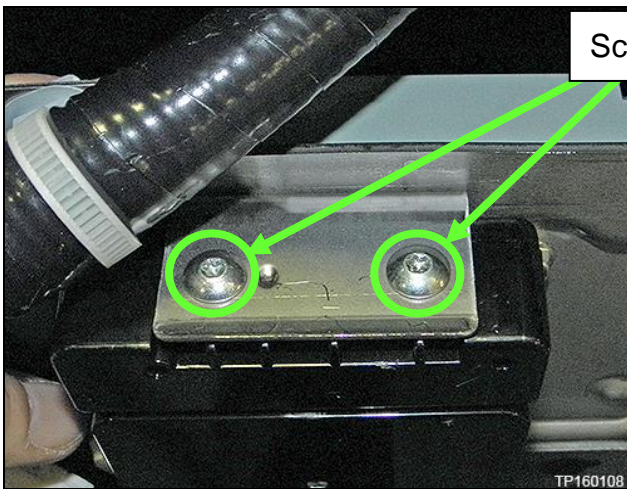

Figure 18

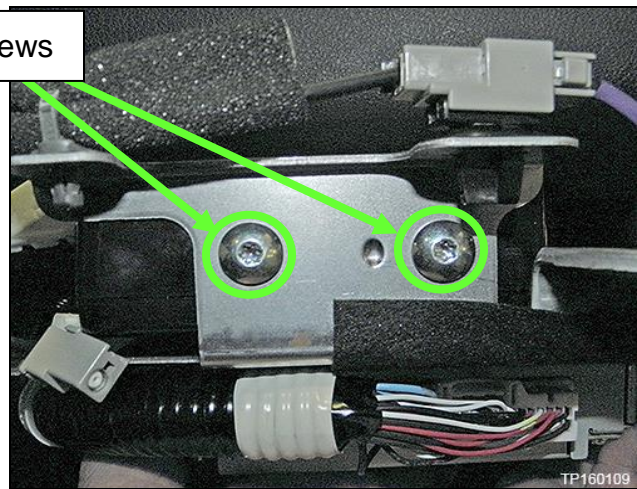

Figure 19

Deactivate the Old TCU and then Activate the New TCU

Steps 1 and 2 must be performed **AFTER** the original TCU is removed from the vehicle and **BEFORE** the new TCU is installed.

1. Collect and have ready the following information:
 - VIN.
 - International Mobile Equipment Identity Number (IMEI) of the original TCU. This number is located on the TCU.
 - IMEI Number of the replacement TCU. This number is located on the TCU.
 - Serial Number of the replacement TCU. This number is located on the TCU.

LABEL ON TCU



Figure 20

2. Call Nissan LEAF TCU Replacement Support at **1-800-922-1528**. (Hours of operation are listed at the bottom of the page.)

NOTE: The phone number shown above is for TCU activation and deactivation **ONLY**. The Support Center agent is unable to assist with matters unrelated to TCU activation and deactivation.

During this call:

- You will be asked for your name, dealership name, and all of the information collected in step 1.
- The Support Center agent will deactivate the original TCU and activate the replacement TCU.

IMPORTANT: Step 2 **MUST** be performed to activate the replacement TCU. If it is not performed the TCU will not be able to communicate with the NissanConnect Global Data Center.

Nissan LEAF TCU Replacement Support – Hours of Operation (Central Time Zone)

Monday – Friday: 7AM – 10PM Saturday: 8AM – 5PM

Special Holiday Hours:

Closed Thanksgiving, Christmas, and New Years Day

Christmas Eve: 7AM – 7PM

New Years Eve: 7AM – 7PM

Install Replacement TCU

- Perform steps 1-6 of **Remove the TCU from the Vehicle** procedure on page 8, in reverse order, to install.

Turn TCU ON

- Perform steps 1-15 of **Turn OFF the TCU** procedure, starting on page 3, to turn the TCU ON and then confirm the **Current status** field shows “On”.

Write VIN Data

1. Select **WRITE VIN (SAVED DATA)**.
2. Select **Start**.

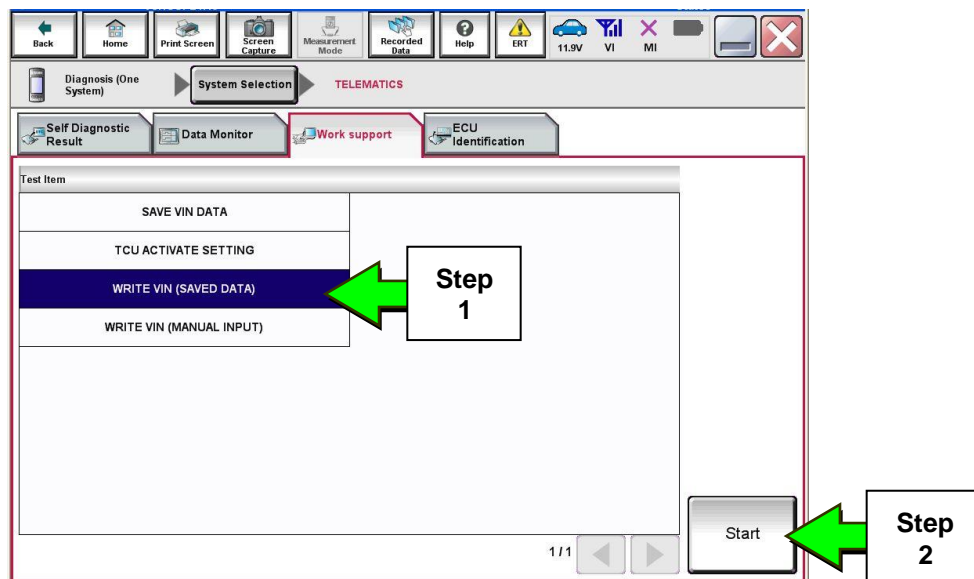

Figure 21

3. Select **Start**.

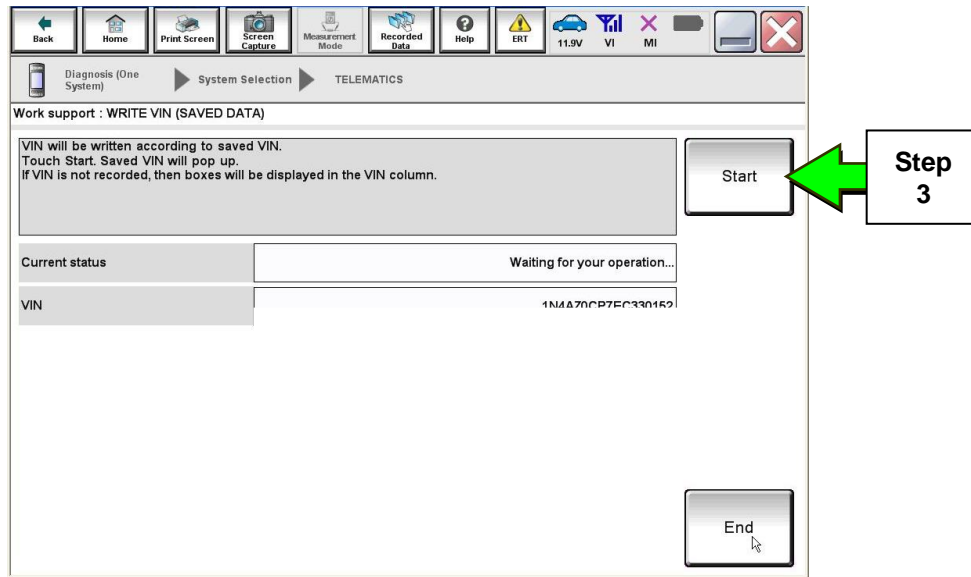

Figure 22

4. Select **End**.

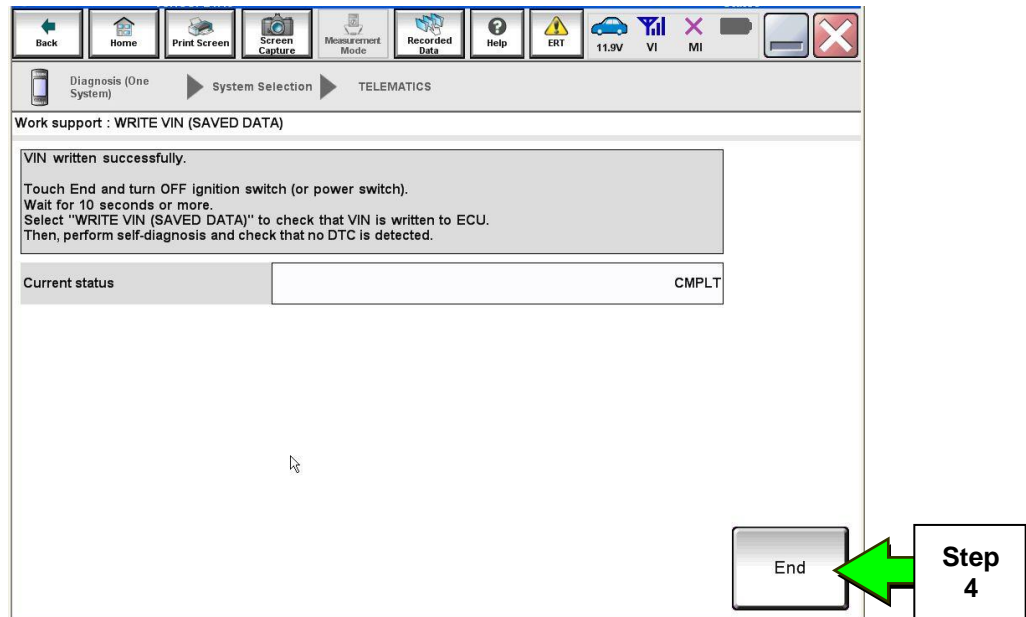

Figure 23

IMPORTANT:

- Wait at least 2 minutes after the ignition is turned ON before checking for DTCs. If DTCs are checked prior to this a U1000 may be stored.

Sign in to TCU with customer's User ID and Password
(Owner has an existing NissanConnect EV account)

1. Press the **Zero Emission button** on the Multifunction Control Panel (Figure 22).



Figure 24

2. Select **CARWINGS**) and then **CARWINGS Settings**.

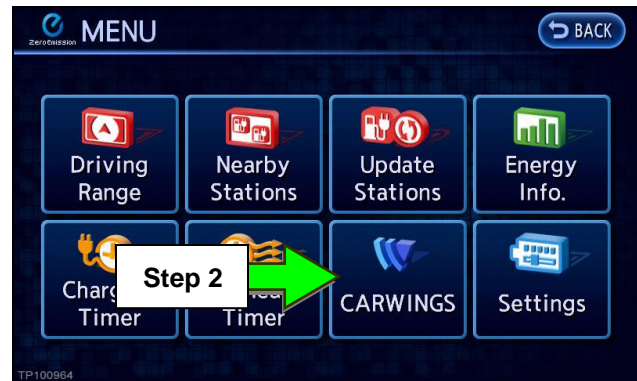

Figure 25

3. Select **Sign in**.



Figure 26

4. Select **Send ID and password** to resend the NissanConnect EV/CARWINGS User ID and Password.

NOTE: The NissanConnect EV/CARWINGS User ID and Password will automatically be entered into these fields after Write VIN Data is performed.

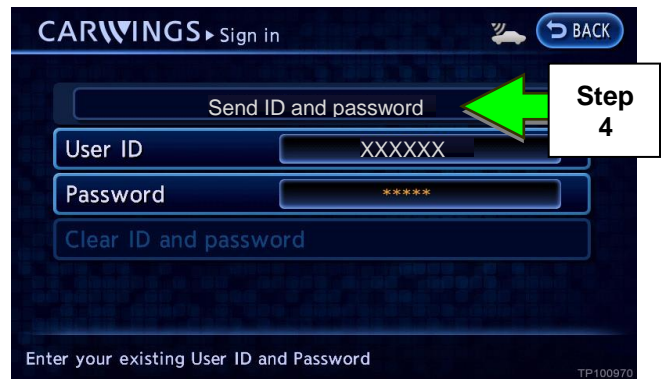

Figure 27

If an owner **does not** have an existing NissanConnect EV account, the owner will have to create an account as follows, then sign into the TCU in their vehicle using their User ID and Password.

1. Create a Nissan Owner Portal account (<https://owners.nissanusa.com/nowners/>)
2. Add your contact information and VIN
3. Agree to the Terms & Conditions
4. Press the Confirm button to obtain the instructions for providing your User ID and Password for the vehicle's information screen
5. Download the NissanConnect EV companion app and log in using your Nissan Owner Portal ID & Password

PARTS INFORMATION

DESCRIPTION	PRODUCTION DATES	PART NUMBER	QUANTITY
Telematics Control Unit	12/1/2012 – 09/30/2015	283B0-3NF2A	1
Telematics Control Unit	9/20/2011 – 11/30/2012	283B0-3NA2A	1
Telematics Control Unit	11/1/2010 – 09/19/2011	283B0-3NA1A	1

CLAIMS INFORMATION

Submit a Campaign (CM) line claim using the following claims coding:

CAMPAIGN ("CM") ID	DESCRIPTION	OP CODE	FRT
PC449	Replace Telematics Control Unit (\$199 Co-Pay)	PC4490	1.1 hrs.
PC450	Replace Telematics Control Unit (No Co-Pay)	PC4500	1.1 hrs.