



PREVOST

ENREGISTRÉ - REGISTERED
ISO 9001 & ISO 14001

**MAINTENANCE
INFORMATION**

Mi12-04C



DATE : MARCH 2012	SECTION : 04 - Exhaust
SUBJECT : WIRING - ACM GROUND AND SUPPLY, DPF TEMP SENSORS, VECU SUPPLY	

Rev C: April 12, 2016. Added parts to splice new wire with spare.

APPLICATION

Model	VIN
H3-45 and H3-45 VIP	EPA 2010 (US10) vehicles up to incl. 2PCVS3497CC712058
X3-45, X3-45 VIP and XLII-45	EPA 2010 (US10) vehicles up to incl. 2PCG3349XCC735274

DESCRIPTION

An improved harness and wiring modification procedure is available to avoid fault codes and messages. Refer to tables below for specific fault code list.

Part “A”

A faulty ground at the Aftertreatment Control Module (ACM) and possible Electromagnetic Interference (EMI) in the DPF (Diesel Particulate Filter) temperature sensors wiring may cause “Check OBD fault” message to appear in the Driver’s Information Display (DID) along with a persistent “engine” MIL lamp.

The following codes may appear

VACDS diagnostic tool	DID on dashboard
MID 128 PID 173 FMI 2	SPN 173 FMI 2
MID 128 PPID 387 FMI 2	SPN 3249 FMI 2
MID 128 PPID 436 FMI 2	SPN 3245 FMI 2
MID 128 PSID 121 FMI 0	SPN 4375 FMI 0

This instruction will improve ACM ground and correct EMI interference issues. Select the appropriate version according to your vehicle, H3 or X3.

Premium Tech Tool is required to complete this part of the bulletin.

Part “B”

Power supply arrangement to the Vehicle Electronic Control Unit (VECU) may cause recurrent “Vehicle ECU fault” codes in the Driver’s Information Display (DID).

The following codes may appear

VACDS diagnostic tool	DID on dashboard
MID 144 PSID 230 FMI 5	N/A

This instruction will modify the supply source to the VECU. Select the appropriate version according to your vehicle, H3 or X3.

MATERIAL

For H3-45 and H3-45 VIP

Order the following parts:

Part No.	Description	Bulletin Part	Qty
068459	Harness	A	1
561890	PED Connector, 4 cavity	A	1
560784	1/4" shrink tube	A	4
504637	Cable Tie 3/16" x 13"	A/B	40
504397	Grommet	A	1
560784	Double wall shrink tube	B	1 ft
562228	Butt splice	B	2
561246	3/8" ring terminal	A	1
682176	Sikaflex 221 Black	A	1
680319	Electrical tape	A/B	1
562593	Cable, yellow, 18 gage, TXL	B	10 ft
562368	Tab terminal 12-8	B	1
562771	Socket terminal 22-18	B	1
563588	Pin terminal 20-16	B	1
563603	Socket terminal 20-16	B	1

For X3-45, X3-45 VIP and XLII-45

Order the following parts:

Part No.	Description	Bulletin Part	Qty
068434	Harness	A	1
504637	Cable Tie 3/16" x 13"	A/B	40
680319	Electrical tape	A/B	1
560784	Double wall shrink tube	B	1 ft
562228	Butt splice	B	2
562368	Tab terminal 12-8	B	1
562593	Cable, yellow, 18 gage, TXL	B	10 ft
562771	Socket terminal 22-18	B	1
563588	Pin terminal 20-16	B	1
563603	Socket terminal 20-16	B	1

NOTE

Material can be obtained through regular channels.

INSTRUCTION PART "A"

H3-45 AND H3-45 VIP - ROUTING OF 068459 HARNESS.

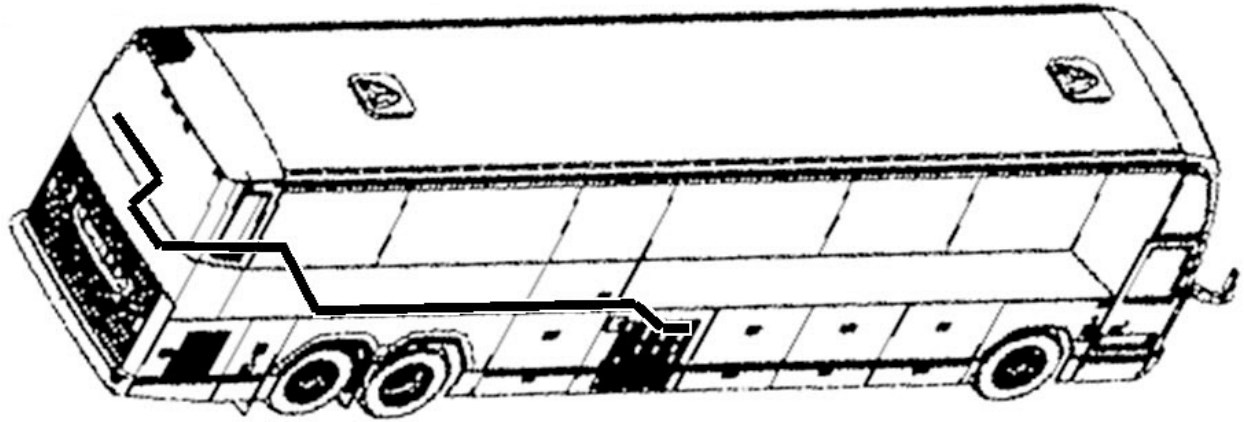

DANGER

Park vehicle safely, apply parking brake, stop engine and set battery master switch(es) to the OFF position prior to working on the vehicle.

1. Follow existing harness in condenser compartment.

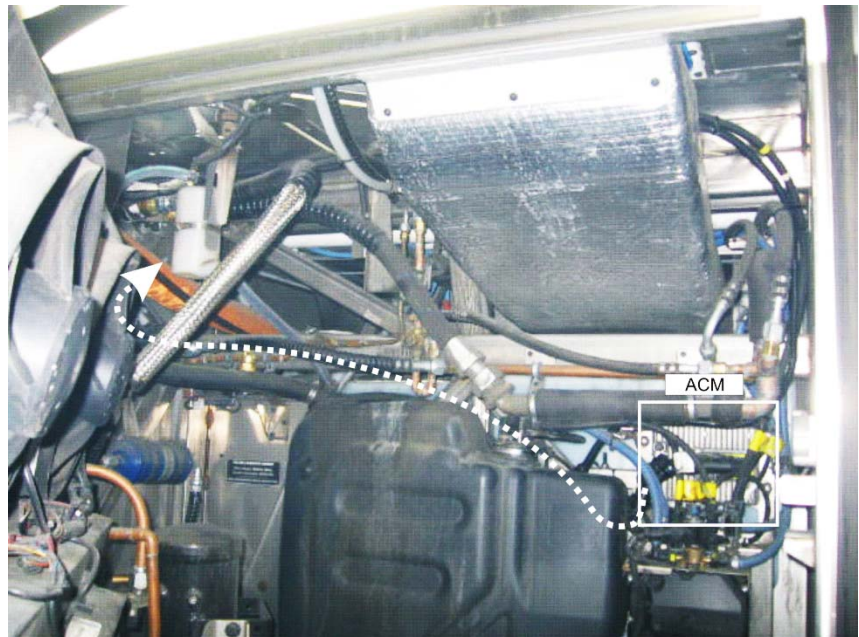

2. Cut and open the ACM harness about 12 inches from ACM connector.

3. Locate wires 511, 512, 513 and 526 and cut them at about 8" from connector

4. Install #561890 PED connector as follows:

Wire 511 to PIN A

Wire 512 to PIN B

Wire 513 to PIN C

Wire 526 to PIN D

5. Seal with shrink tube the existing 4 wires

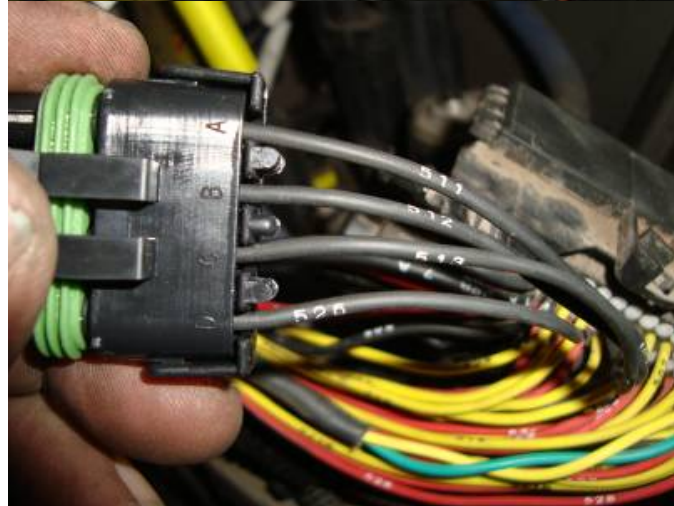

6. Tape the wires inside the harness. Tape the convoluted tubing.

7. Connect and secure the mated PED connectors to the main harness with cable ties.



8. Locate the ground stud behind the DEF tank and cut ground wire 0RB7, leaving some length for solder.

9. Solder 0RB7-12 wire with the 0RB7 wire, part of the new harness. Heat shrink the connection

10. Secure all cables

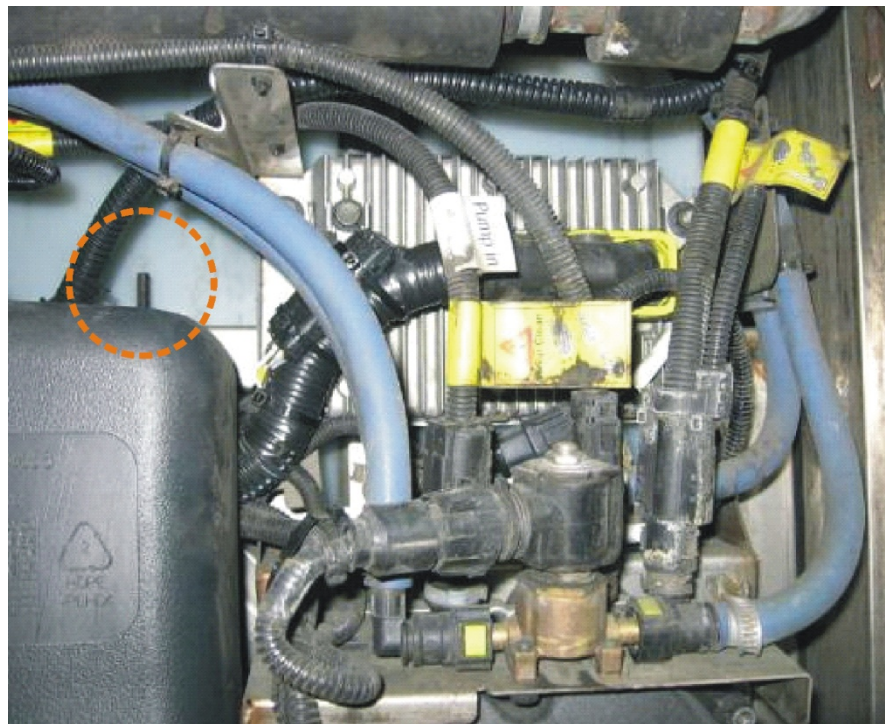

11. Routing in last luggage bay –Follow existing harness.

DO NOT ATTACH TO DEF LINES.



12. Drill 1-1/8" hole using a unibit style bit and install rubber grommet #504397.

13. In rear axle well, run harness through grommet and seal with Sikaflex 221 #682176.



14. Run harness down and attach to the air line going to the back of the engine, LH of air tank.



In engine compartment. Accessible through rear access panel inside the coach, close to the restroom. Looking towards the left.

15. Run harness from the tag axle area (previous step) up to the back of the coach following main harness.

Ground cable (black) should be run to the rear electrical compartment.



16. Harness routing in engine compartment

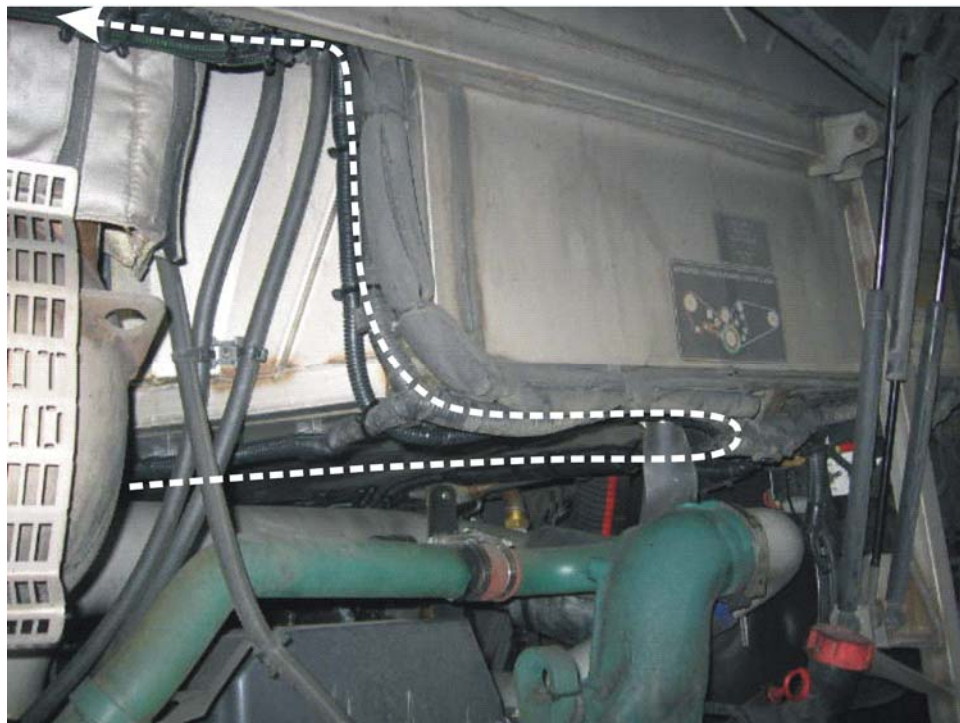

17. Open exhaust aftertreatment system access door.

18. Disconnect existing temp sensor connectors.

19. Connect harness to DPF temp sensor connectors, B85, B97 and B98.

20. Seal and secure unused connectors.

21. In rear electrical compartment, route cable as shown.

22. Remove grey plastic cover and connect #561246 ring terminal to electronic ground.



Using Premium Tech Tool open VCADS pro and verify Fault Codes.

Next will be to go to the DPF Service Regeneration page 2545-08-03-03 and start a Park Regeneration.

Monitor all 3 temperature sensors to confirm all 3 sensors are reading correctly.

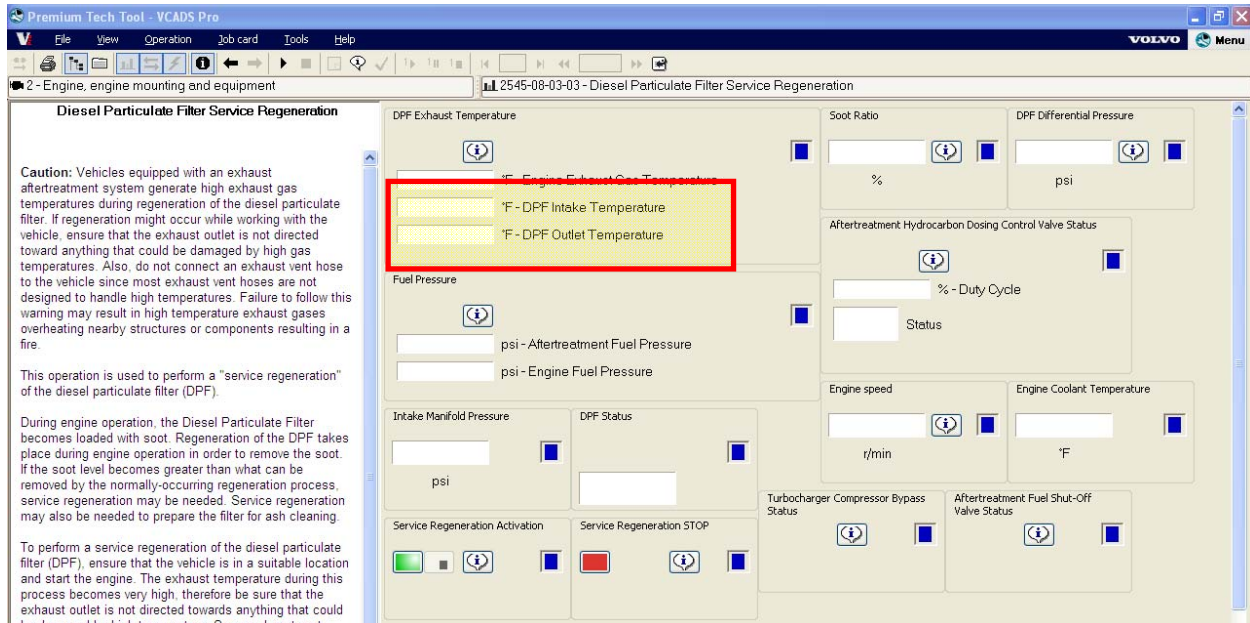

INSTRUCTION PART "A"

X3-45, X3 VIP AND XLII-45 – ROUTING OF 068434 HARNESS.



DANGER

Park vehicle safely, apply parking brake, stop engine and set battery master switch(es) to the OFF position prior to working on the vehicle.

General view of X3 routing from the ACM in condenser compartment up to the DPF

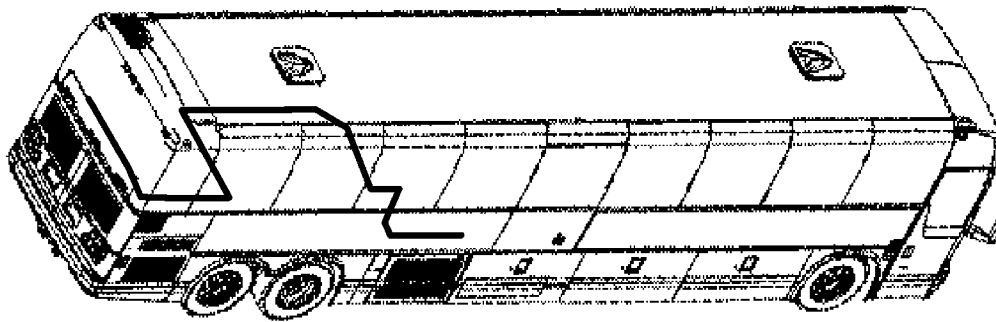

Top view of suggested harness routing. As a reference, position green tape on transversal cable support above transmission. Routing is realised from this point up to DPF and up to ACM in condenser compartment.

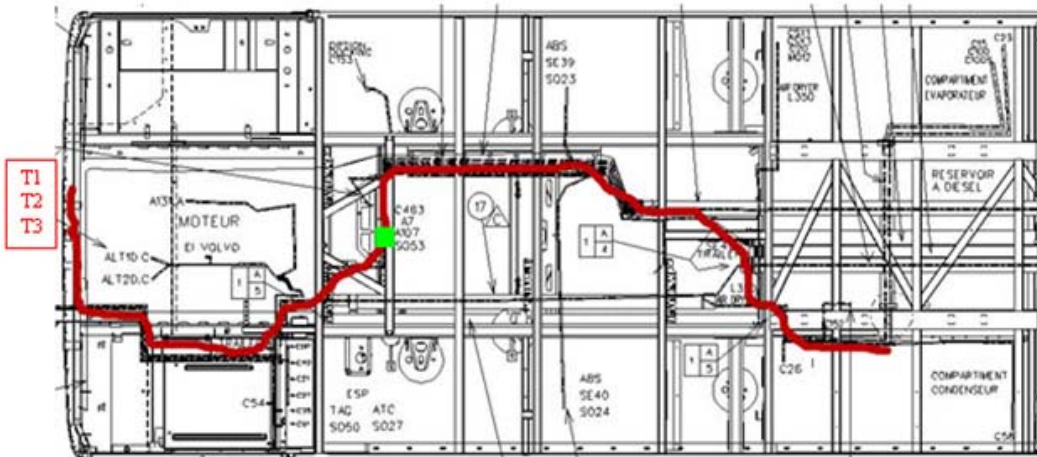

1. Place green tape on transverse cable support above transmission.

Use rear floor hatch to position harness.



2. Route 0RB8B ground cable to rear electrical compartment.
3. Use any available passage through rubber boot, upper or lower.



- 4. Ground connexion in rear electrical compartment

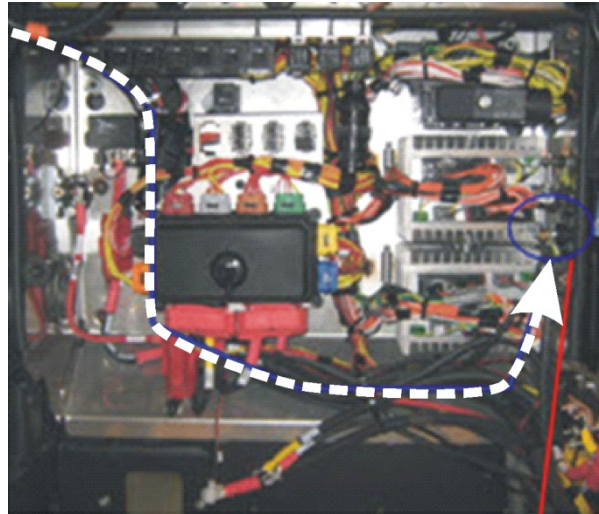

- 5. Routing towards DPF.



6. Open Exhaust system aftertreatment access door.

7. Disconnect existing temp sensor connectors.

8. Connect harness to DPF temp sensor connectors, B85, B97 and B98.

9. Seal and secure unused connectors.



10. From green tape up to condenser compartment, over tag and drive axles.

11. Use any existing free passage from axle well to condenser compartment.

12. Make sure harness is not exposed to sharp edges.

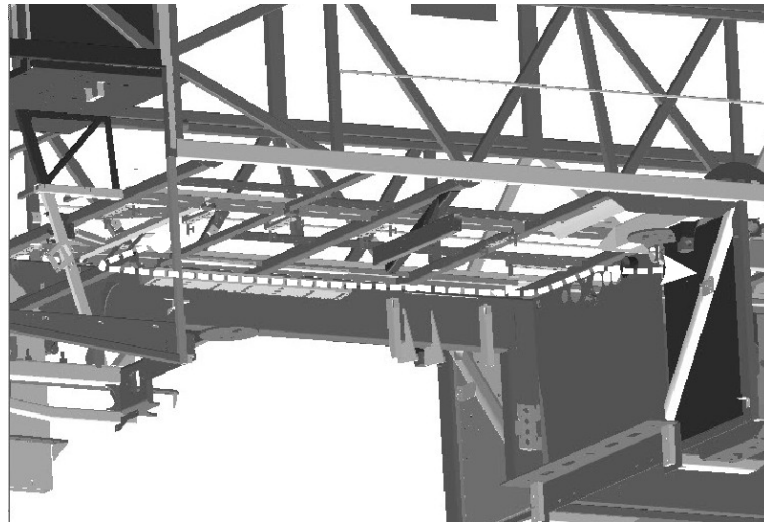

Routing and connections at the ACM

13. Follow existing harness in condenser compartment.

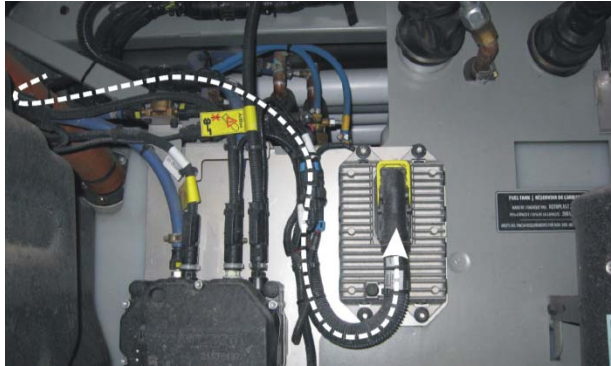

14. Open the ACM harness to access back of connector.

15. Locate and remove wires below:

Wire	Pin
511	39
512	42
513	34
526	55
ORB7	57
ORB7A	58
ORB7B	59

16. Replace removed wires with wires from harness #068434.

Wire	Pin
511	39
512	42
513	34
526	55
ORB8	57
ORB8A	58
ORB8B	59

When removing wires, lightly push yellow lock lever to release terminals.

Use extractor tools #687976 & #683594 to replace pins.

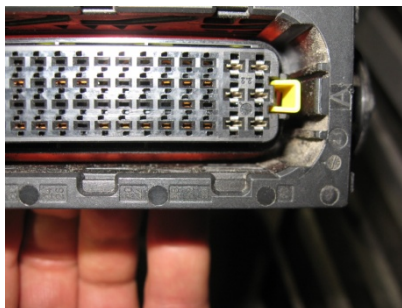
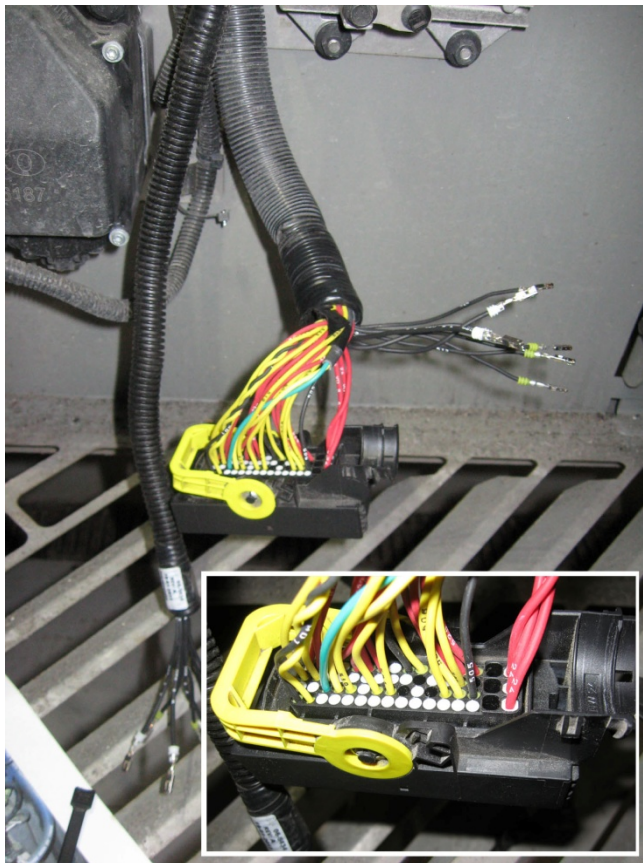

17. Tape the wires inside the harness.
Tape the convoluted tubing.



Using Premium Tech Tool open VCADS pro and verify Fault Codes.

Next will be to go to the DPF Service Regeneration page 2545-08-03-03 and start a Park Regeneration.

Monitor all 3 temperature sensors to confirm all 3 sensors are reading correctly.

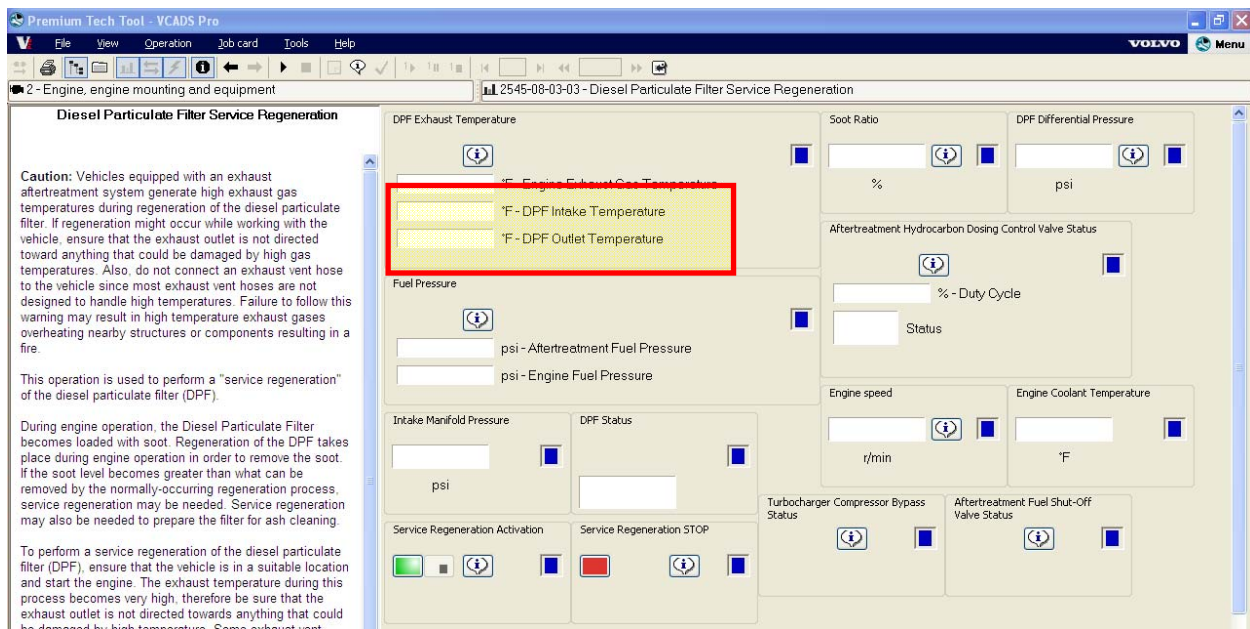

PARTS / WASTE DISPOSAL

Discard waste according to applicable environmental regulations (Municipal/State[Prov.]/ Federal)

INSTRUCTION PART "B" - H3-45 AND H3-45 VIP

1. In rear electrical compartment, locate **R31**
2. Cut existing tab terminal at pin 30.
3. Crimp new wire #562593 and existing 12ECU wire on #562368 tab terminal. Replace at pin 30 of R31.
4. Install #563588 pin and #563603 socket terminal to pass new wire through C21.
5. (Use extractor tool #682321)
6. Splice new wire end with SP17.
#562228 butt splice
#560784 shrink tube
7. Locate SP17 in front electrical and service compartment it is located near C2.
8. Cut wire 12 CPC at VECU JA13.
9. Run a new 12CPC wire from spare wire SP17 to JA13. Install # 562771 terminal and connect.
10. Once completed, remove R22 Relay from VECF as it is now unused.

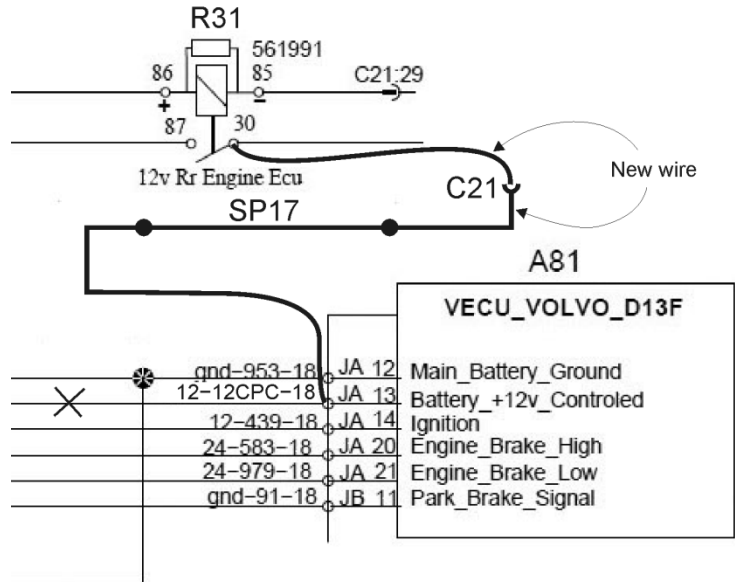

INSTRUCTION PART “B” - X3-45, X3-45 VIP AND XLII-45

1. In rear electrical compartment, locate **R34**
2. Remove existing tab terminal at pin 30.
3. Crimp a new wire #562593 and existing 12ECU wire on #562368 tab terminal. Replace at pin 30 of R34.
4. Install #563588 pin and #563603 socket terminal to pass through C21. (Use extractor tool #682321 as required)
5. Connect new wire end with SP17.
#562228 butt splice
#560784 shrink tube
6. In front electrical and service compartment, cut wire 12VECU at VECU JA13 in front junction box.
7. Run a new 12VECU wire from SP17 to JA13. Install # 562771 terminal and connect.
8. Once completed, remove R22 Relay from VECF as it is now unused.

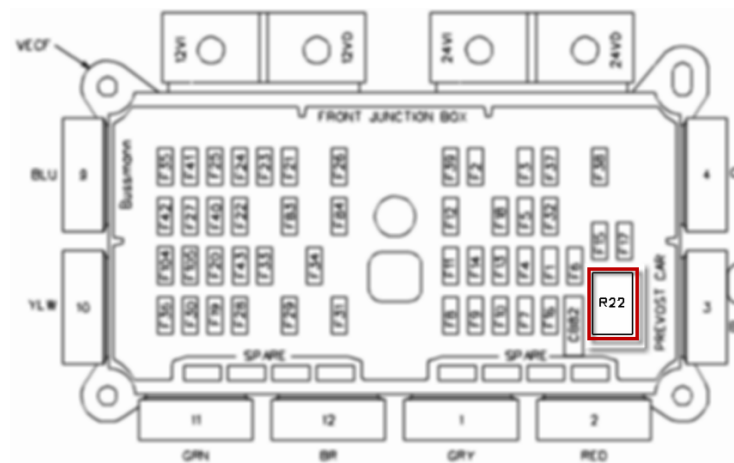
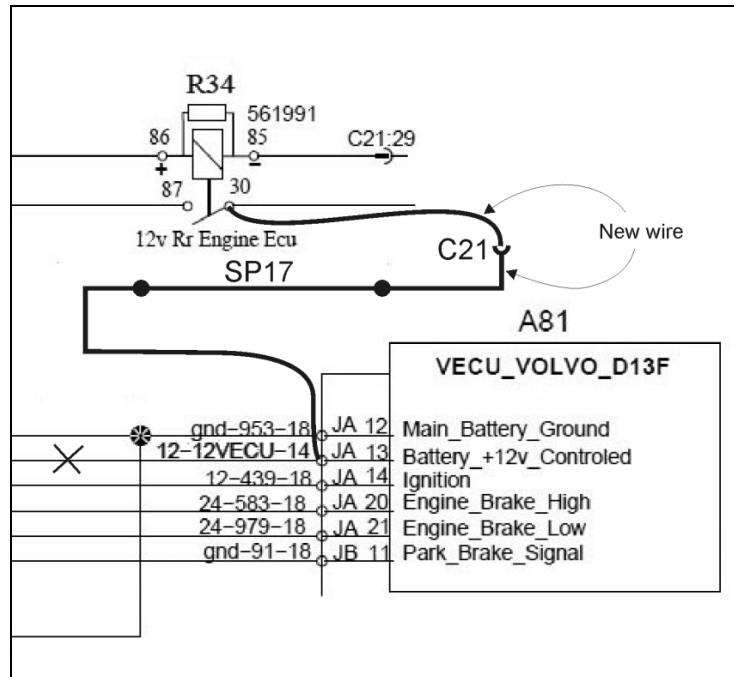

PARTS / WASTE DISPOSAL

Discard waste according to applicable environmental regulations (Municipal/State[Prov.]/ Federal)