

TECHNICAL BULLETIN

JTB00432NAS2

13 OCT 2015



© Jaguar Land Rover North America, LLC

NOTE: The information in Technical Bulletins is intended for use by trained, professional Technicians with the knowledge, tools, and equipment required to do the job properly and safely. It informs these Technicians of conditions that may occur on some vehicles, or provides information that could assist in proper vehicle service. The procedures should not be performed by 'do-it-yourselfers'. If you are not a Retailer, do not assume that a condition described affects your vehicle. Contact an authorized Jaguar service facility to determine whether this bulletin applies to a specific vehicle.

This reissue replaces all previous versions. Please destroy all previous versions.

Changes are highlighted in gray

SECTION: 501-00

Vibrations and/or Rattles When Listening to the Entertainment System

AFFECTED VEHICLE RANGE:

F-TYPE (X152)

Model Year: 2014-2015
VIN: K00001-K27000
Manufacturing Plant: Castle Bromwich

MARKETS:

NAS

CONDITION SUMMARY:

Situation: Vibrations and/or rattles may be evident when listening to the entertainment system.

Cause: This may be caused by trim and/or wiring contact.

Action: Should a customer express this concern, follow the Service Instruction below.

PARTS:

T2R21202	Foam insulator kit	Quantity: 1
T2R21163	NVH pad	Quantity: 2
T2R21164	NHV pad	Quantity: 2

TOOLS:



NOTE: this 'Active Bulletin' will display a functional programming shortcut if accessed within a diagnostic session using SDD.

SDD with latest DVD and Calibration File

Jaguar Land Rover-approved Midtronics battery power supply

Refer to the Service Instruction/Workshop Manual for any required special tools.

WARRANTY:



NOTE: Repair procedures are under constant review, and therefore times are subject to change; those quoted here must be taken as guidance only. Always refer to TOPIx to obtain the latest repair time.



NOTE: DDW requires the use of causal part numbers. Labor only claims must show the causal part number with a quantity of zero.

DESCRIPTION	SRO	TIME (HOURS)	CONDITION CODE	CAUSAL PART
Checking the software level of the Audio Amplifier Module using SDD	86.99.99	0.2	42	T2R10501
Configuring the Audio Amplifier Module using SDD	86.99.42	0.6	42	T2R10501
Door trim panel removed for access - Single door	76.34.01.90	0.2	42	T2R10501
Door trim panel removed for access - Both doors	76.34.15.90	0.3	42	T2R10501
Rear subwoofer speaker - Renew - Coupe	86.51.05.12	0.6	42	T2R10501
Rear subwoofer speaker - Renew - Convertible	86.51.05.70	0.5	42	T2R10501
Insulating components - Single door	05.10.30	0.3	42	T2R10501

Insulating components - Both doors	05.10.50	0.5	42	T2R10501
Insulating components - Single door and parcel shelf	05.10.70	0.7	42	T2R10501
Insulating components - Both doors and parcel shelf	05.10.90	0.9	42	T2R10501

 **NOTE: Normal Warranty procedures apply.**

SERVICE INSTRUCTION 'A'

 **CAUTION: a Jaguar Land Rover-approved Midtronics battery power supply must be connected to the vehicle battery during SDD diagnosis / module programming.**

 **CAUTION: ensure all ignition 'ON' / ignition 'OFF' requests are carried out; failure to perform these steps may cause damage to control modules in the vehicle.**

 **NOTE: SDD must be loaded with DVD142.06 v.215 or later.**

- 1 Connect the Jaguar Land Rover-approved Midtronics battery power supply to the vehicle battery.
- 2 Turn ignition 'ON' (engine not running).
- 3 Connect the Symptom Driven Diagnostics (SDD) system to the vehicle and begin a new session.
- 4 Follow the on-screen prompts, allowing SDD to read the VIN and identify the vehicle and initiating the data collect sequence.
- 5 Check the software level of the Audio Amplifier Module (AAM).
 - If a software update is available, continue to the next step.
 - If no software update is available, continue to Service Information.
- 6 Select 'Diagnosis' from the Session Type screen.
- 7 Select the 'Selected Symptoms' tab and then select:
 - Electrical > Information and entertainment system > Entertainment system
- 8 Select 'continue'.
- 9 Select the 'Recommendations' tab, and then select '**Run**' to perform the 'Configure existing module - Audio amplifier module' option.
- 10 Follow all on-screen instructions to complete this task, ensuring all DTCs are cleared.
- 11 Exit the current session.
- 12 Disconnect the SDD and the battery power supply from the vehicle.

SERVICE INFORMATION:

- 1 The Service Instruction comprises three levels of repair:
 1. Left door
 2. Right door
 3. Parcel shelf
 - Only carry out the Service Instruction(s) ['B' or 'C'] below as per the customer complaint.

SERVICE INSTRUCTION 'B'

Door vibration or rattle insulation procedure

1  **NOTE: left door shown; right door similar.**

Remove the door trim panel as required (see TOPIx Workshop Manual, section 501-05).

2 Remove the door panel.

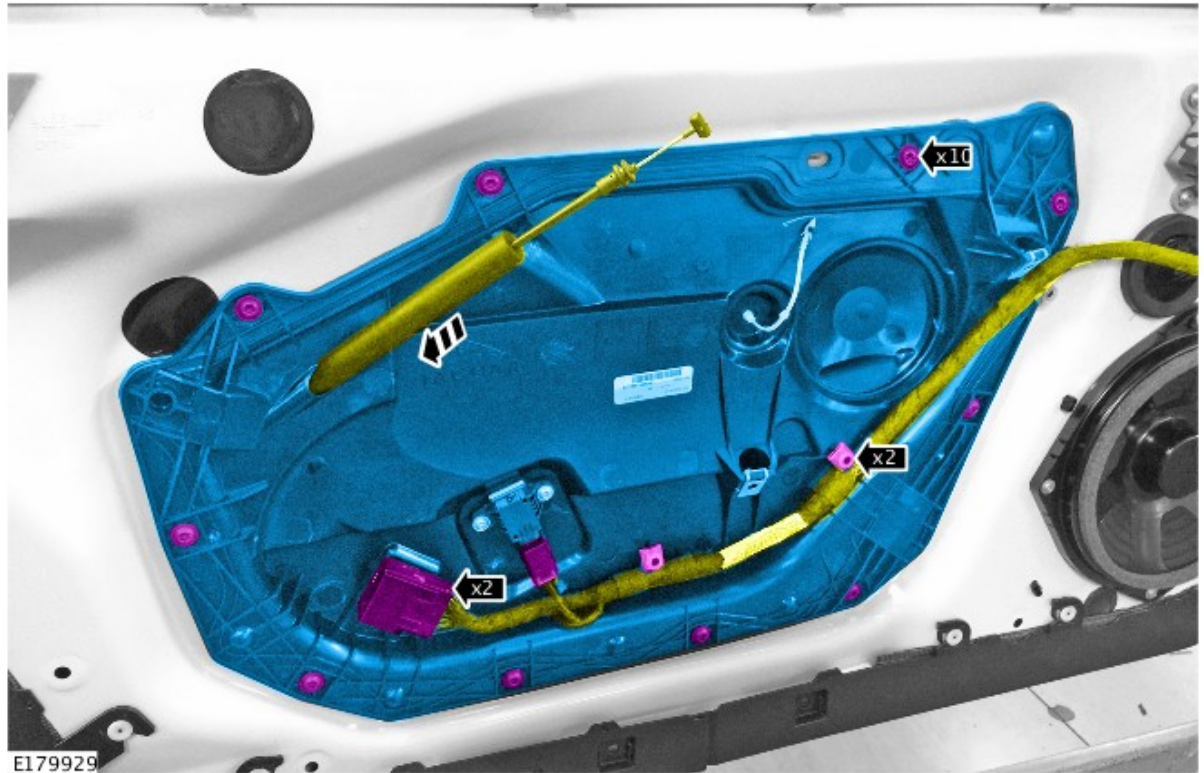

3 Install a foam insulating block in between the electrical wiring harness retaining clip and the door as shown.

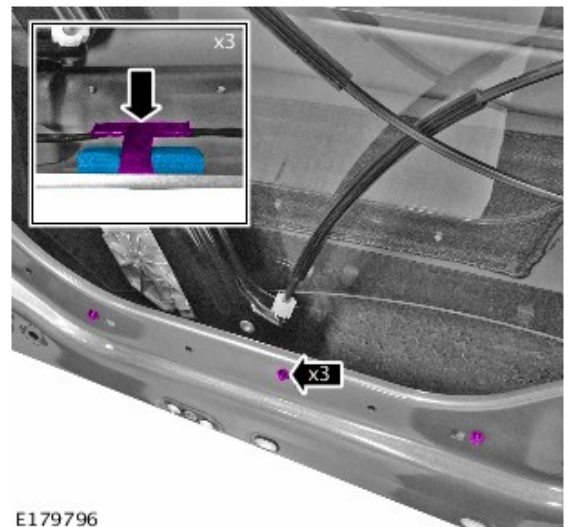

4 **CAUTION:** make sure when installing the felt insulation tape a gap of 40mm is left at the connector end to allow for electrical wiring harness movement.

Install the felt insulation tape along the length of the door electrical wiring harness.

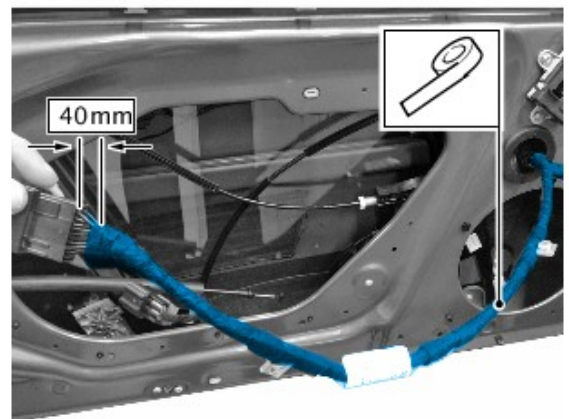

- 5 Install a second layer of felt insulation tape to the door electrical wiring harness retaining clips.

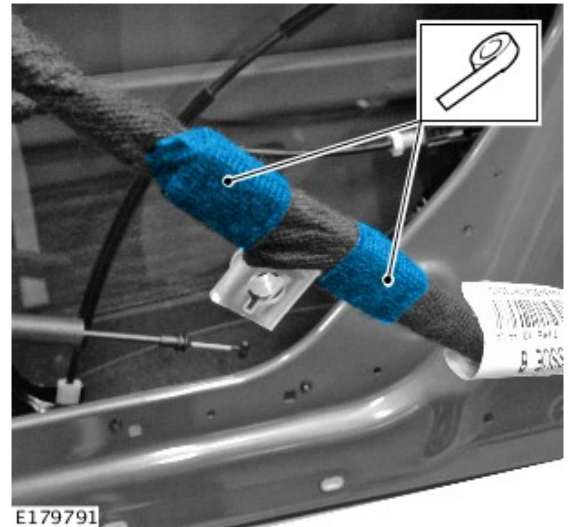

- 6 **CAUTION:** make sure when installing the felt insulation tape a gap of 40mm is left at the connector end to allow for electrical wiring harness movement.

Install the felt insulation tape along the length of the door electrical wiring harnesses.

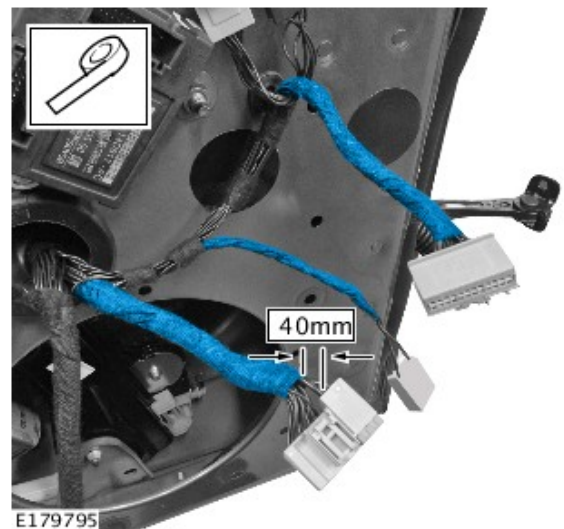

- 7  **CAUTION:**
the Noise,
Vibration
and
Harshness
(NVH) pads
must be
installed at
a
temperature
of 74°F to
adhere
correctly.

Install the NVH pads inside the door as shown.

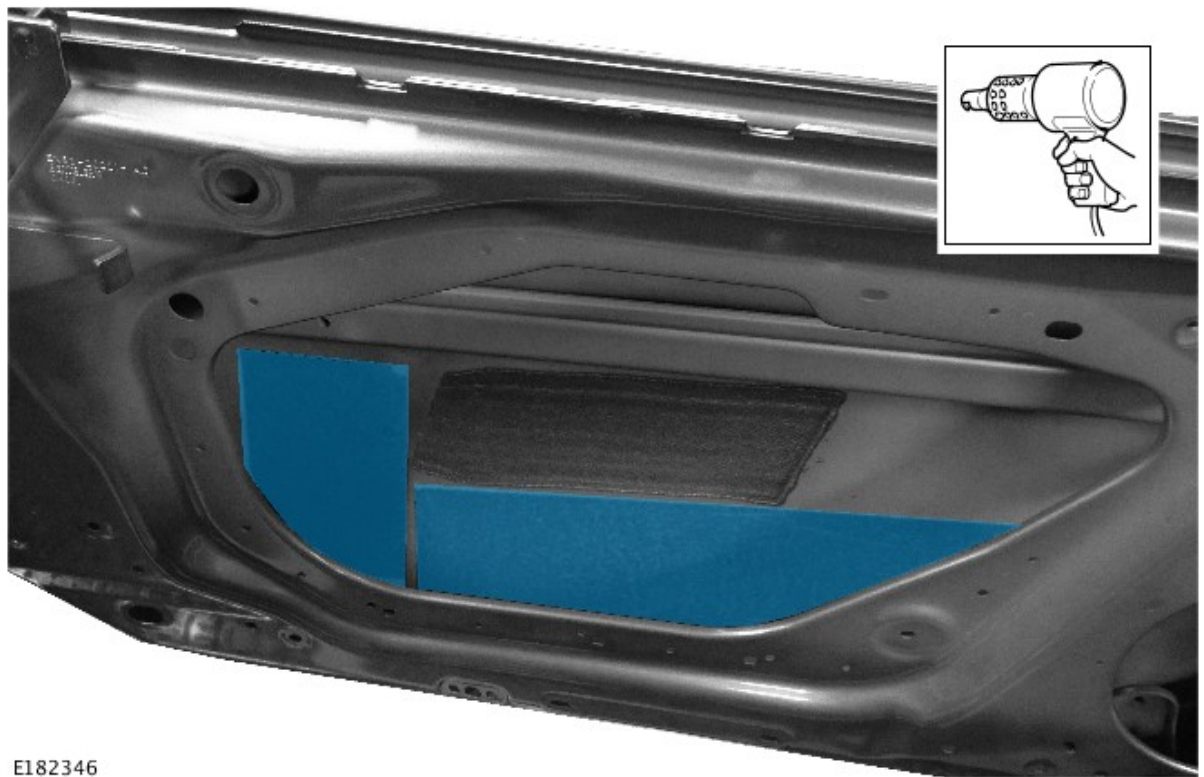

E182346

- 8 Remove the self adhesive pads from the door to access the exterior door handle retaining nuts.

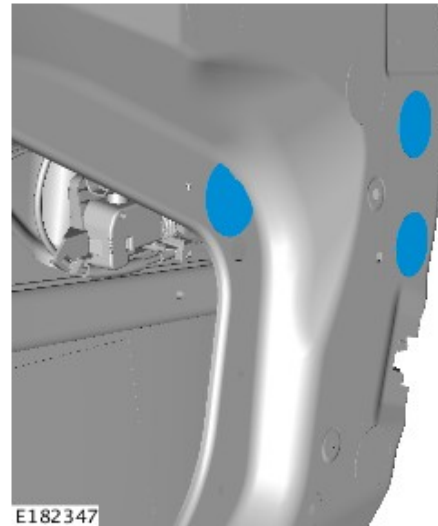

E182347

- 9 Loosen but do not remove the exterior door handle retaining nuts.
- Turn the retaining nuts seven complete turns in an anti clockwise direction.

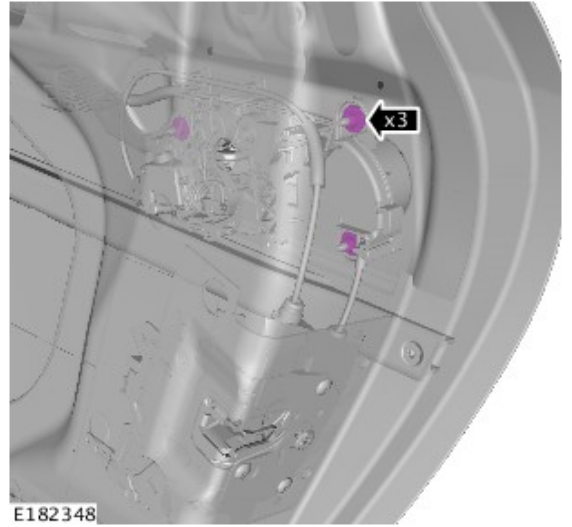

10 Position the exterior door handle to one side.

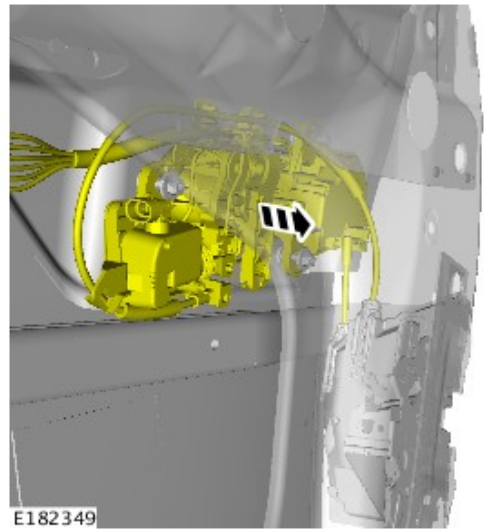

11 When installing the foam pad in Step 12, make sure it is aligned as shown.

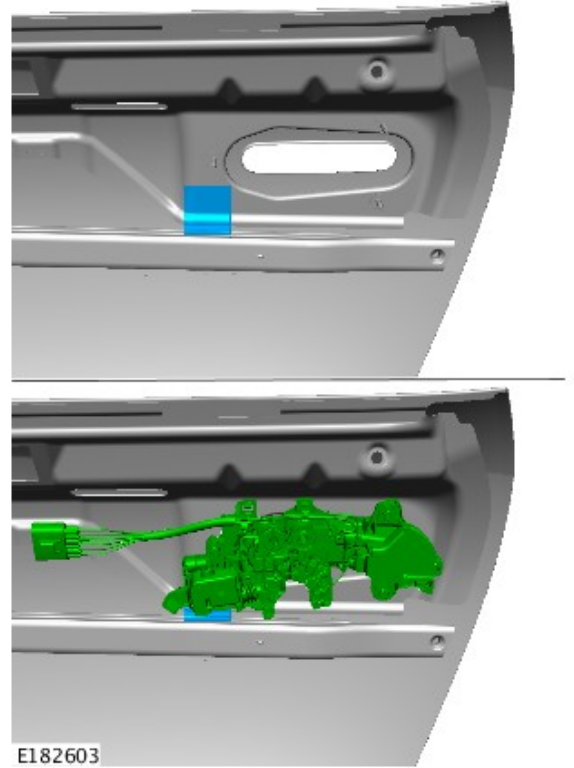

12 Install the foam pad behind the exterior door handle.

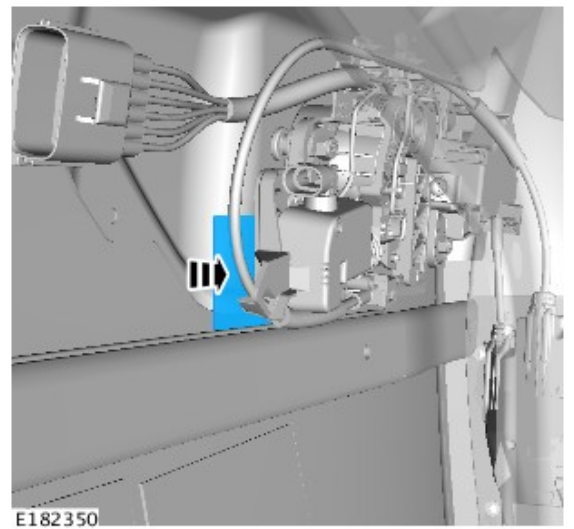

13 When installing the exterior handle make sure there is an even gap around its outer edge..

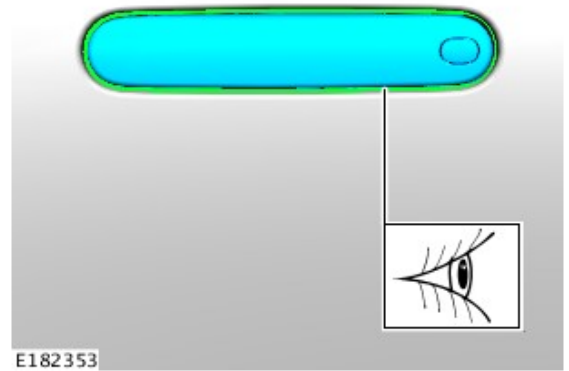

14 Install the exterior door handle retaining nuts.

- Torque: 8 Nm

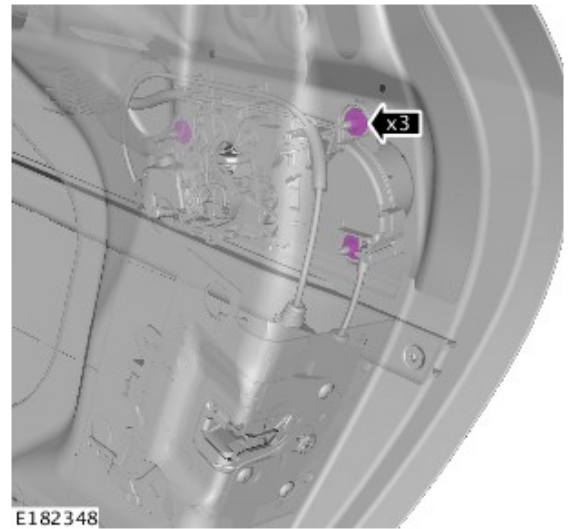

15 Remove the self adhesive pads from the the exterior door handle retaining nuts.

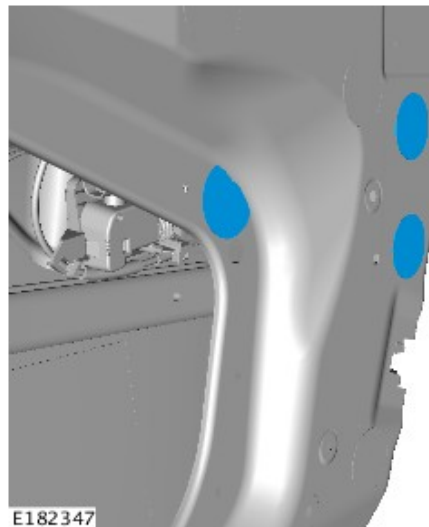

16When installing the door panel, make sure that the locating lugs are correctly located into the door.

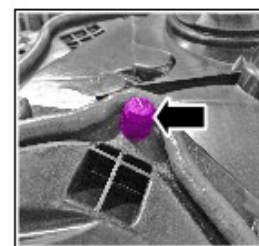
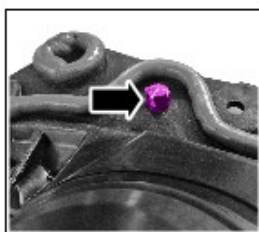

E179789

17  **NOTE:**
do not
tighten the
retaining
screws at
this stage.

Install the door
panel.

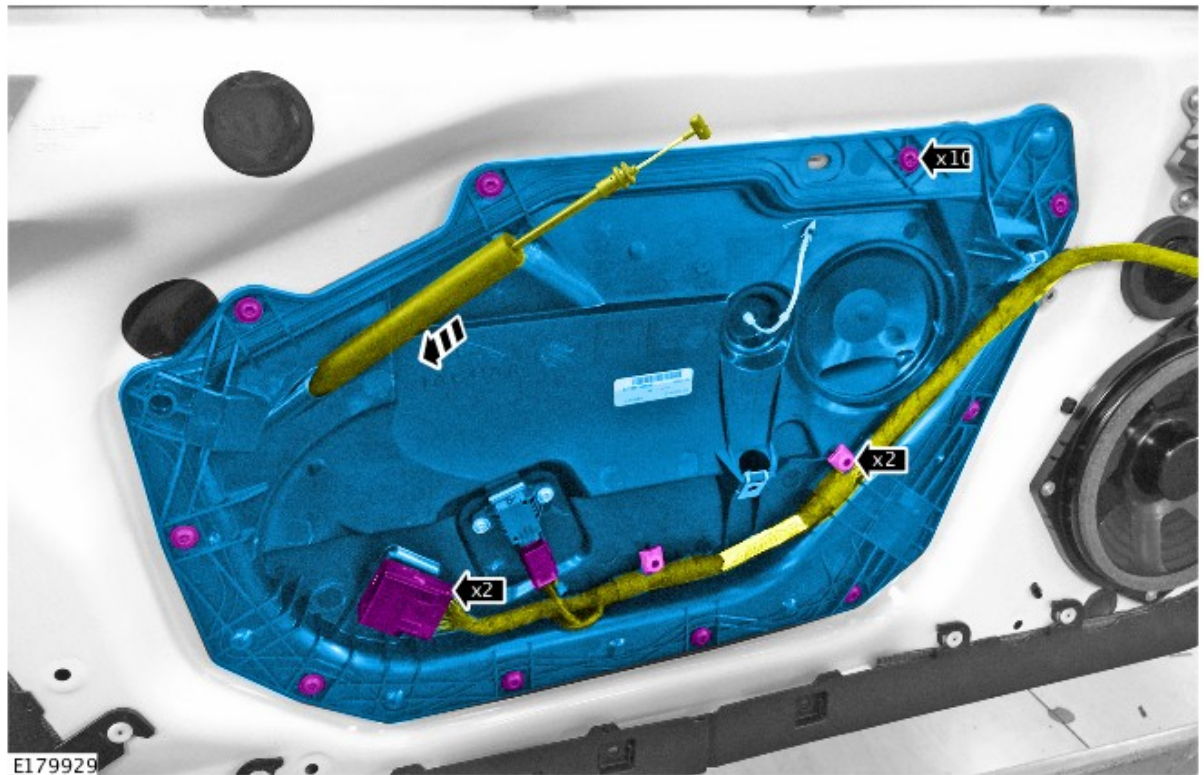

18 Tighten the
retaining
screws in the
sequence
shown.

- Torque:
1.5Nm

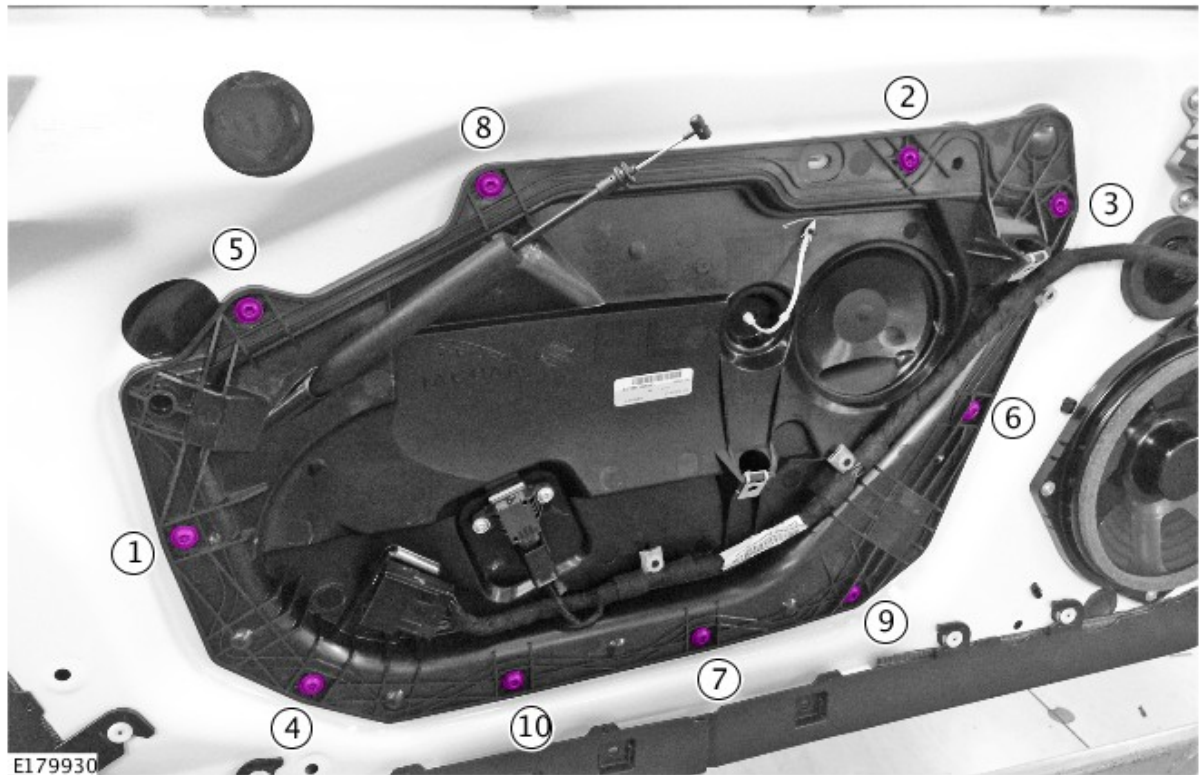

E179930

19 Install the foam noise insulators to the door.

- The foam block should be aligned with the door panel (1).
- The foam pad must be installed behind the label on the door electrical wiring harness, the exact location of the label may vary between vehicles (2).

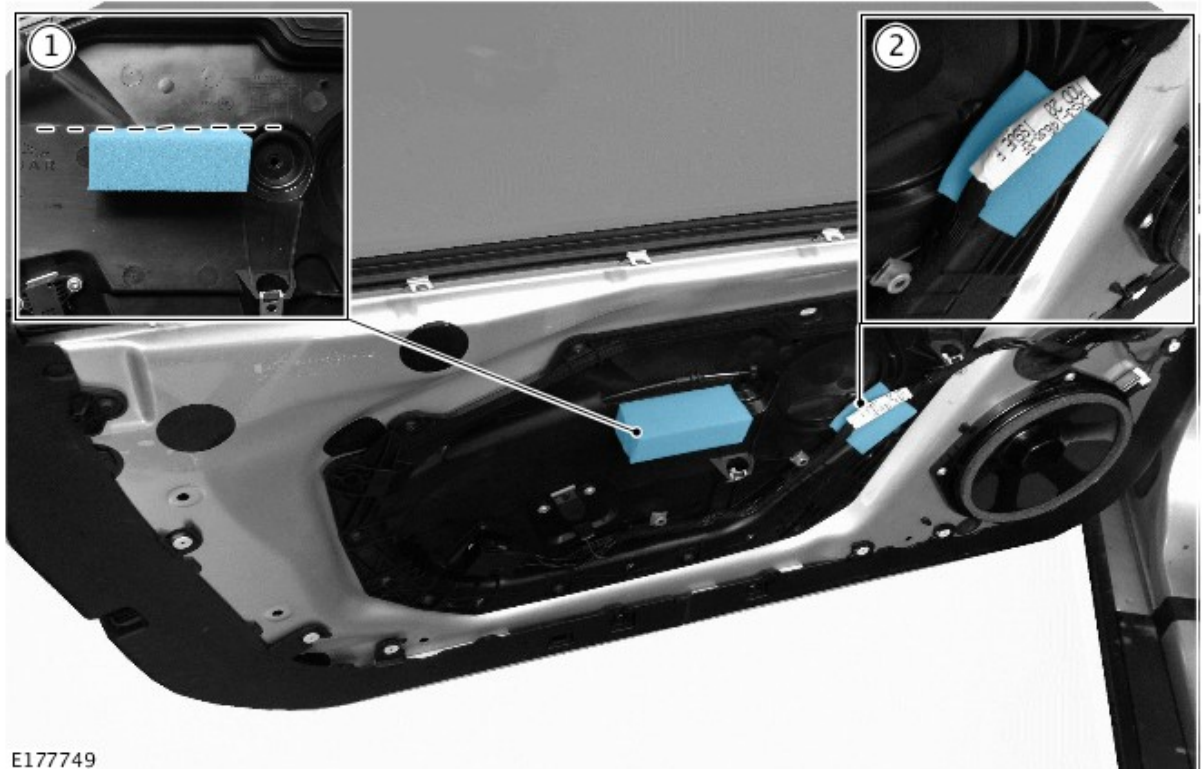

E177749

20 Remove the door trims.



E179941

21 Install 0.5mm felt insulation tape to the door trim as shown.

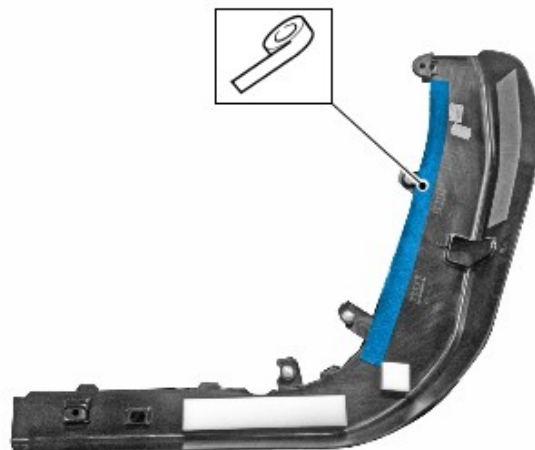

E179792

22 Install 0.5mm felt insulation tape to the door trim as shown.

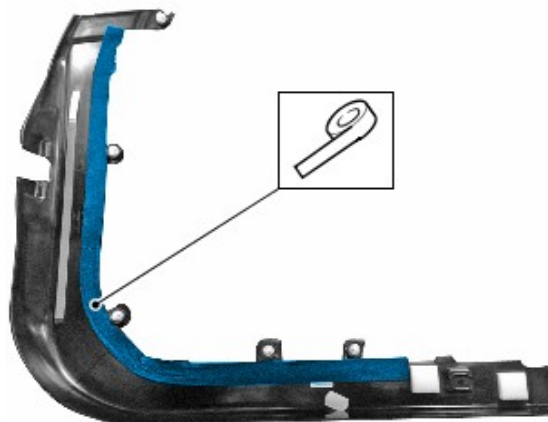

E179793

- 23 Install the foam pads behind the door trim panel electrical wiring harness.

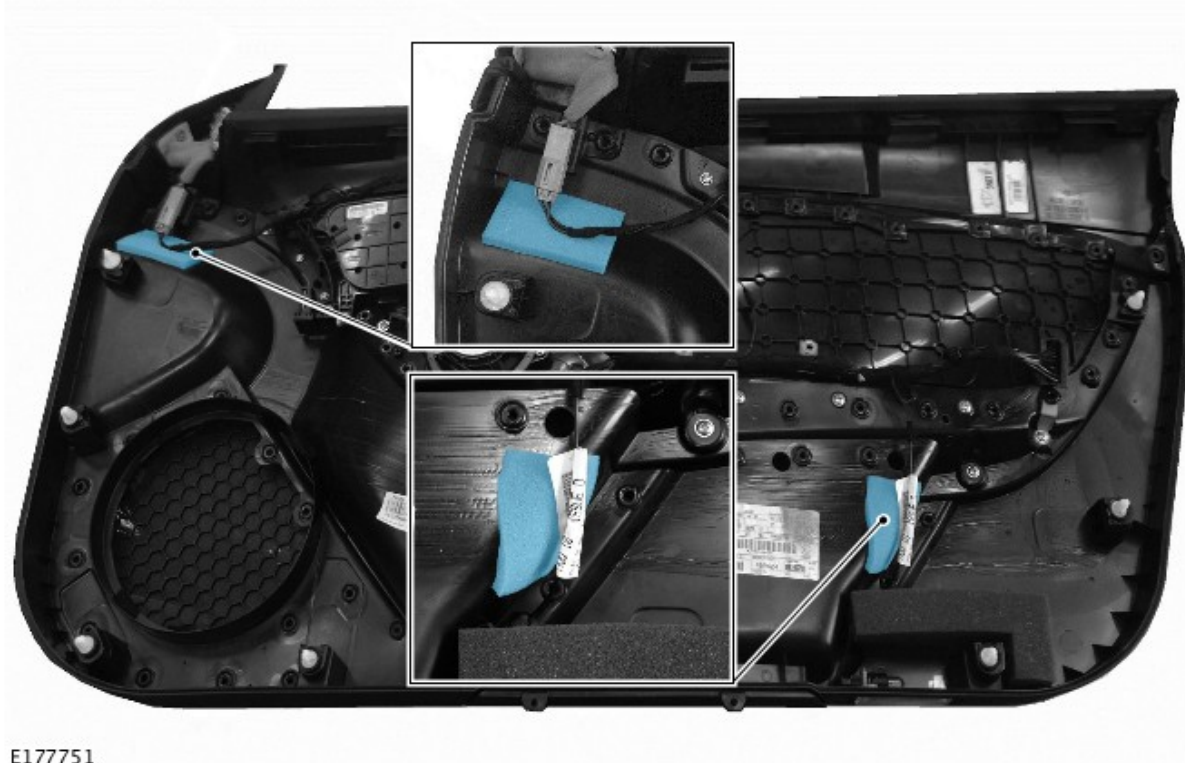

E177751

- 24  **CAUTION:** make sure when installing the felt insulation tape a gap of 40mm is left at the connector end to allow for electrical wiring harness movement.

Install felt insulation tape to the door trim electrical wiring harness.

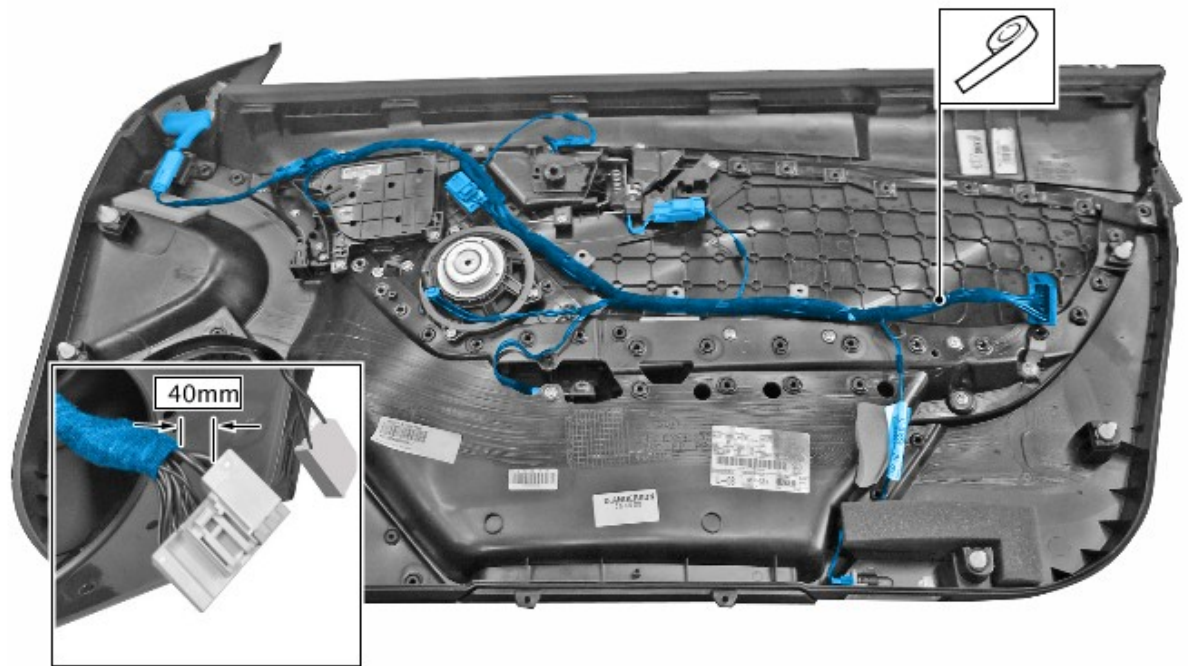

E179794

25 Inspect the speaker grille on the door trim panel.

- Using a suitable feeler gauge check the clearance between the speaker baffle and the door trim panel.
- If a clearance is found proceed to step 6. If no clearance is found proceed to Step 7



E177750

26 Using a suitable trim tool, install felt tape between the speaker baffle and the door panel trim.



E177752

27 Repeat Steps 1-26 for the other side of the vehicle if required.

28 To install, reverse the removal procedure.

SERVICE INSTRUCTION 'C'

Parcel Shelf Vibration or Rattle Insulation Procedure

1 Remove the subwoofer speakers (see TOPIx Workshop Manual, section 415-01).

2  **NOTE:**
Convertible
shown;
Coupe
similar.

When the parcel shelf is removed, install foam pads to the contact areas shown.



E177756

3  **NOTE: the exact position and quantity of the foam pad(s) necessary to install will be determined by the routing of the electrical wiring harness.**

Install the foam pad(s) where the electrical wiring harness is in contact with the vehicle body

when the subwoofer speaker is installed.

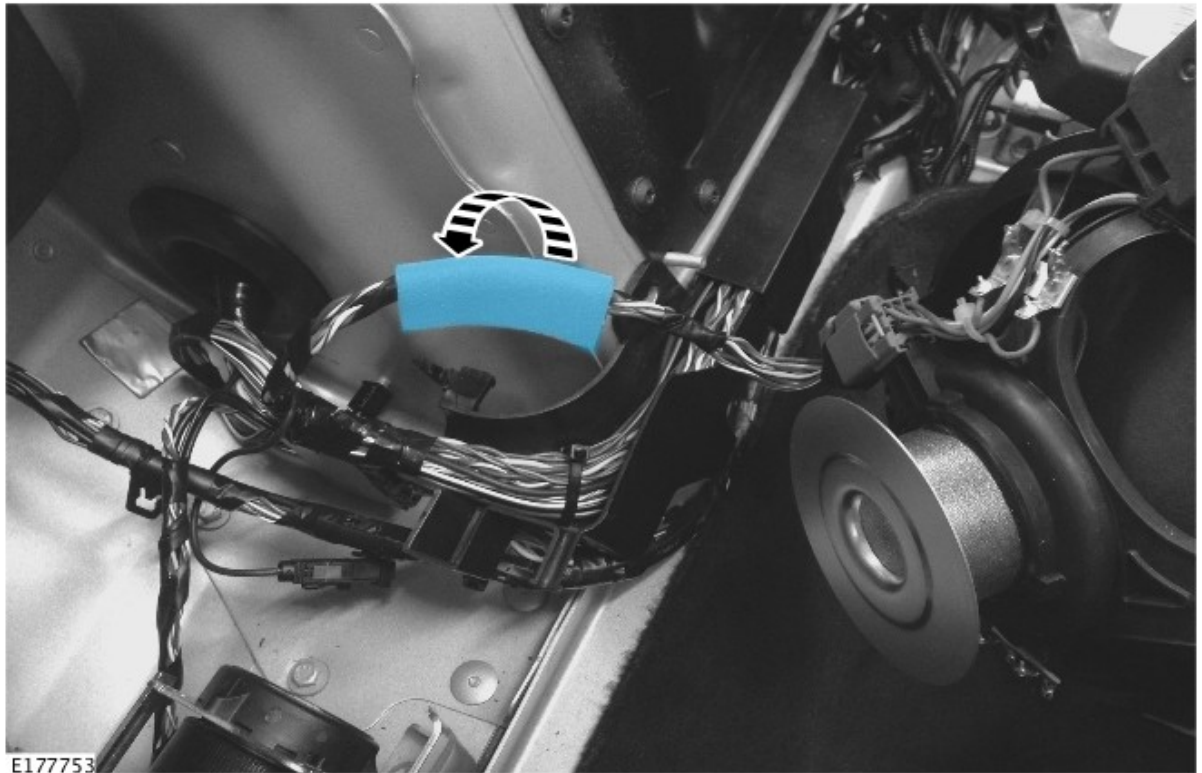

4 Make sure when installing the subwoofer the electrical wiring harness is installed into the body cavity,

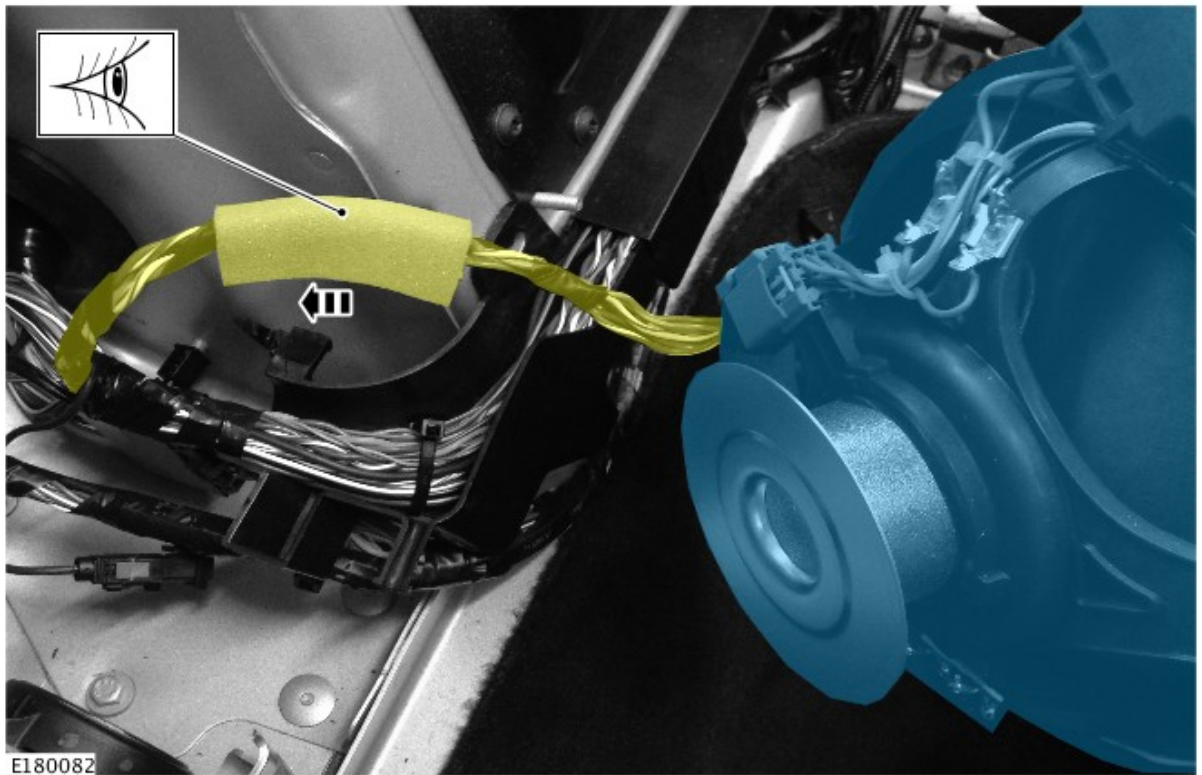

5  **NOTE: repeat for both sides of the vehicle.**

Before installing the subwoofer speakers install the foam block as shown.

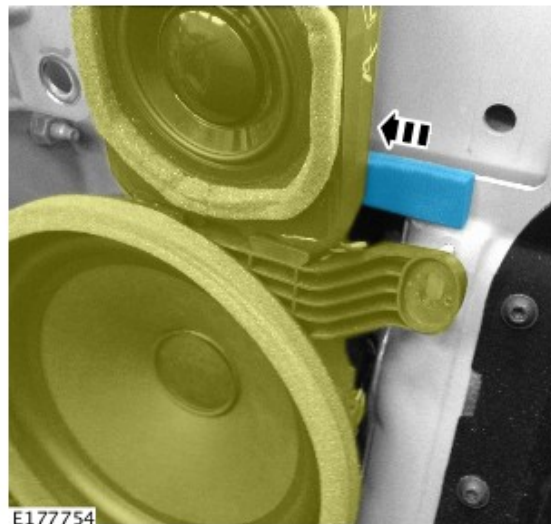

6  **NOTE: repeat for both sides of the vehicle.**

Install the rubber insulator on the subwoofer speaker.

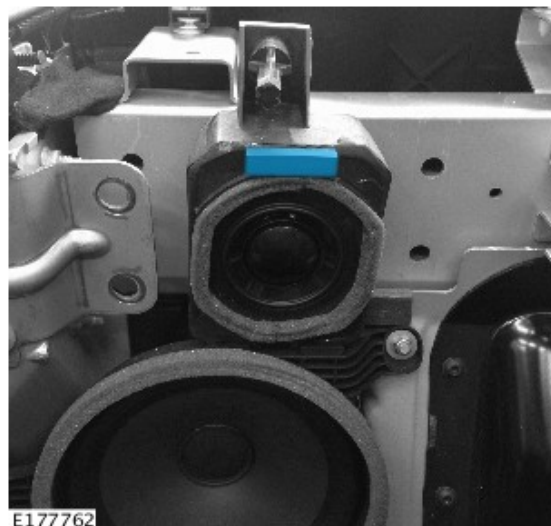

7 Install the foam pads on the electrical wiring harness conduit.

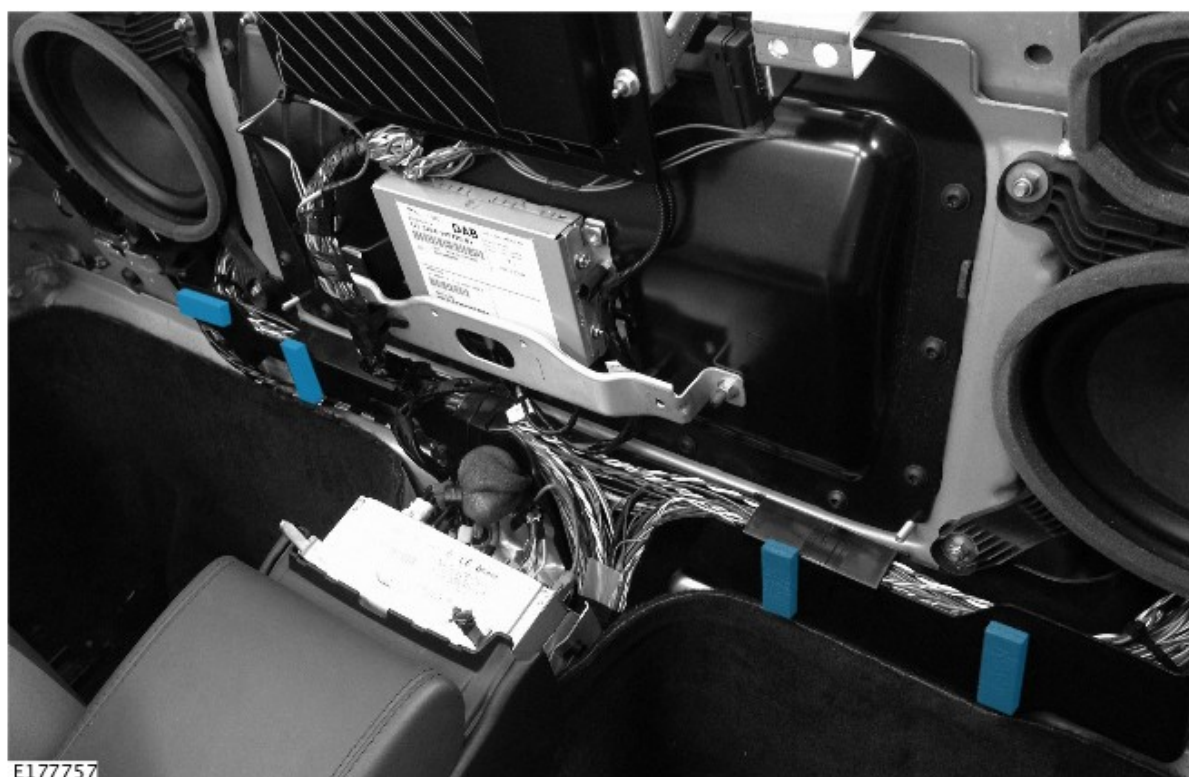

8 Make sure the electrical wiring is routed and retained correctly.

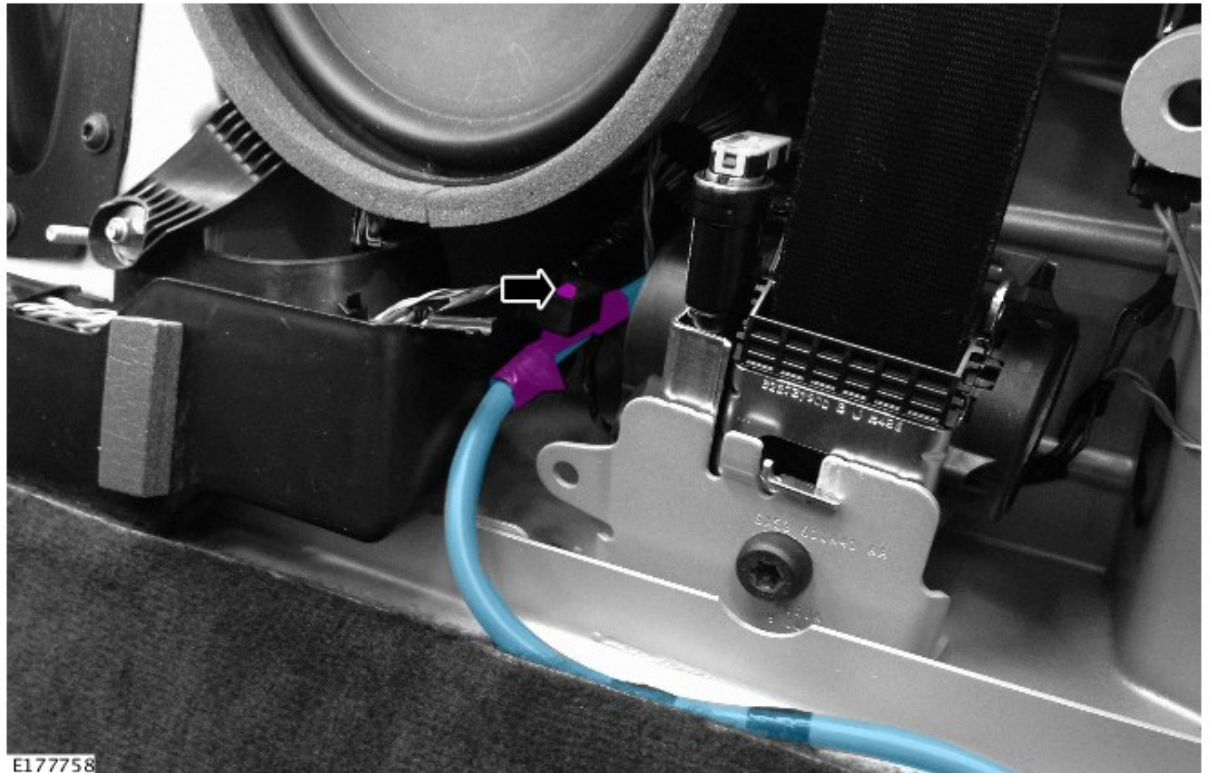

9  **NOTE: it is important that the felt pads wrap around the retaining lugs so they are insulated on both sides.**

Before installing the covers to the subwoofer speakers make sure the retaining lugs are covered with the felt pads.

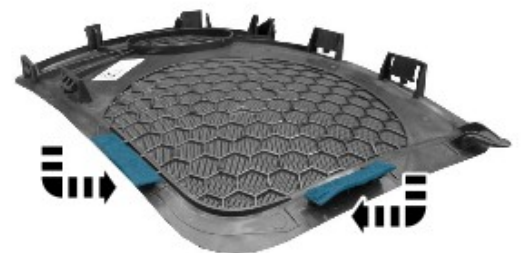

E17755

10To install, reverse the removal procedure.