



Service Bulletin

SERVICE UPDATE

SUBJECT: Service Update for Inventory Vehicles Only
Transmission Gear Whine Noise
Expires April 30, 2016

MODELS: 2015 Cadillac Escalade, Escalade ESV
2015 Chevrolet Silverado LD Crew, Silverado LD Crew LTZ,
Silverado LD Ext LTZ
2015 GMC Sierra LD Crew, Sierra LD Crew Denali, Sierra LD Ext,
Yukon, Yukon Denali, Yukon XL, Yukon XL Denali
Equipped with 8-Speed Transmission (M5U) and 6.2L Engine (L86)

The Parts Information, Service Procedure and Warranty Transaction Information sections have been revised. Part numbers 11546930 and 11612187 have been removed. Repair steps 15, 16 and 17 have been modified. Floor plan reimbursement instructions have been added. Please discard all copies of bulletin 15178.

This service update involves vehicles in dealer inventory only and will expire April 30, 2016.

PURPOSE

This bulletin provides a service procedure to perform a drive audit and, if necessary, replace the reaction/output carrier assembly and associated parts on certain 2015 model year Cadillac Escalade, Escalade ESV; Chevrolet Silverado LD Crew, Silverado LD Crew LTZ, Silverado LD Ext LTZ; and GMC Sierra LD Crew, Sierra LD Crew Denali, Sierra LD Ext, Yukon, Yukon Denali, Yukon XL, Yukon XL Denali vehicles equipped with an 8-speed transmission (M5U) and a 6.2L engine (L86). Some of these vehicles may exhibit a transmission gear whine noise at 1000-2000 RPM and between 20 mph (32 kph) and 35 mph (56 kph).

This service procedure should be completed on involved vehicles currently in dealership inventory as soon as possible but no later than April 30, 2016, at which time this bulletin will expire.

VEHICLES INVOLVED

All involved vehicles are identified by VIN in the Global Warranty Management System – Investigate Vehicle History Application. Dealership technicians should always check this site to confirm vehicle involvement prior to beginning any required inspections and/or repairs. It is important to routinely use this tool to verify eligibility because not all similar vehicles may be involved regardless of description or option content.

Additionally, a list of involved vehicles currently in dealer inventory is available on the “Service Update Bulletin Information” link under the “Service” tab in GM GlobalConnect (U.S.) or attached to the GlobalConnect message (Canada) used to release this bulletin.

PART INFORMATION

Parts required to complete this service update are to be obtained from General Motors Customer Care and Aftersales (GMCCA). Please refer to your “involved vehicles listing” before ordering parts. This part will be on Order Writing control initially and all DRO’s (Daily Replenishment Orders) will cancel. Dealers can place orders CSO (Customer Special Order). In emergency situations a dealer should place a SPAC case and the orders will be processed in the order received.

Note: Do NOT order parts unless a repair is required. Use the vehicle identification number (VIN), SI and the GM Electronic Parts Catalog to determine which parts to order. The transmission replacement procedure in SI states what parts are required to complete the repair. For example, gaskets, one-time use fasteners and fluids.

Part Number	Part Description	Quantity/Vehicle
24259393	REACTION CARRIER ASSEMBLY	1 (If Req'd)
11547864	BOLTS, PARK PAWL	2 (If Req'd)
11546433	BOLTS, SENSOR	2 (If Req'd)
23107857	RETAINER,RR PROP SHF	2 (If Req'd)
11548472	BOLT,RR PROP SHF	4 (If Req'd)
15077362	SEAL,EXH SYS - RH	1 (If Req'd)
15035747	SEAL,EXH SYS - LH	1 (If Req'd)
26064275	CLAMP,F/AXL PROP SHF SLIP YOKE BOOT	1 (If Req'd)
24245110	GASKET,TRFER CASE ADAP	1 (If Req'd)
23135703	SEAL,TRANS FLUID CLR PIPE FTG	1 (If Req'd)
11547366	TRANSMOUNT BOLTS	2 (If Req'd)
19300536-US 19300537-CA	FLUID,A/TRANS (DEXRON HP ATF) (1 QUART)	8 (If Req'd)
Kent-Moore J-36850-A (Obtain Locally*)	TRANSGEL LUBRICANT (1LB. TUB - 20 APPLICATIONS PER TUB)	1 Application (If Req'd) (Submit in Net Item)

* If not available, an equivalent such as petroleum jelly may be used. Do not order from GMCCA.

SERVICE PROCEDURE

Note: Gear whine noise, if present, is typically observed at 1000-2000 RPM and between 20 mph (32 kph) and 35 mph (56 kph). Drive conditions that may reveal the gear whine noise are provided below. Perform the repair procedure in this bulletin if gear whine noise is present in any gear or RPM range.

Under light drive condition coming from a stop:

- Third gear: a little gear whine

- Fourth gear: gear whine becomes very apparent
- Fifth gear: gear whine still high but lower level compared to fourth gear

Under coast coming to a stop:

- Fifth gear: gear whine still high but lower level compared to fourth gear
 - Fourth gear: gear whine becomes very apparent
 - Third gear: a little gear whine
1. Drive the vehicle for about 15-20 minutes at various speeds up to 40 mph (64 kph) to determine if gear whine noise is present.
 - If gear whine noise is NOT present, no further action is required.
 - If gear whine noise is present, refer to *Reaction Carrier Gear Noise Repair* in this bulletin.

Reaction Carrier Gear Noise Repair

Caution: This repair must be performed with the transmission off-vehicle, do not attempt this repair with the transmission in the vehicle. Several internal components are held in place by the extension and if done on-vehicle they will come out of alignment during reassembly causing damage to internal components.

1. Remove the transmission from the vehicle and mount to DT-48989 transmission holding fixture. Refer to *Transmission Replacement* in SI.
2. Remove the 15 bolts securing the fluid pan and gasket to the transmission.

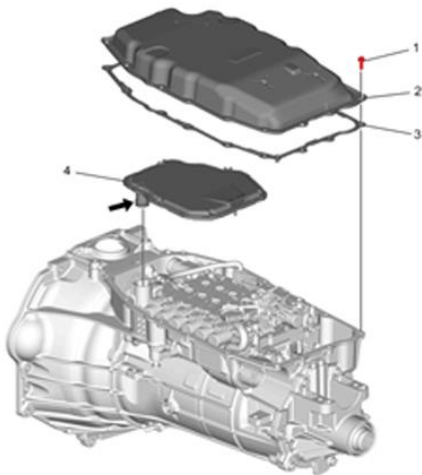

4119366

Note: The fluid pan gasket is reusable. Inspect the gasket to determine if it may be reused. If the gasket is stuck to the case or pan, it should be replaced.

3. Remove the fluid pan and gasket. The fluid filter does not need to be removed.

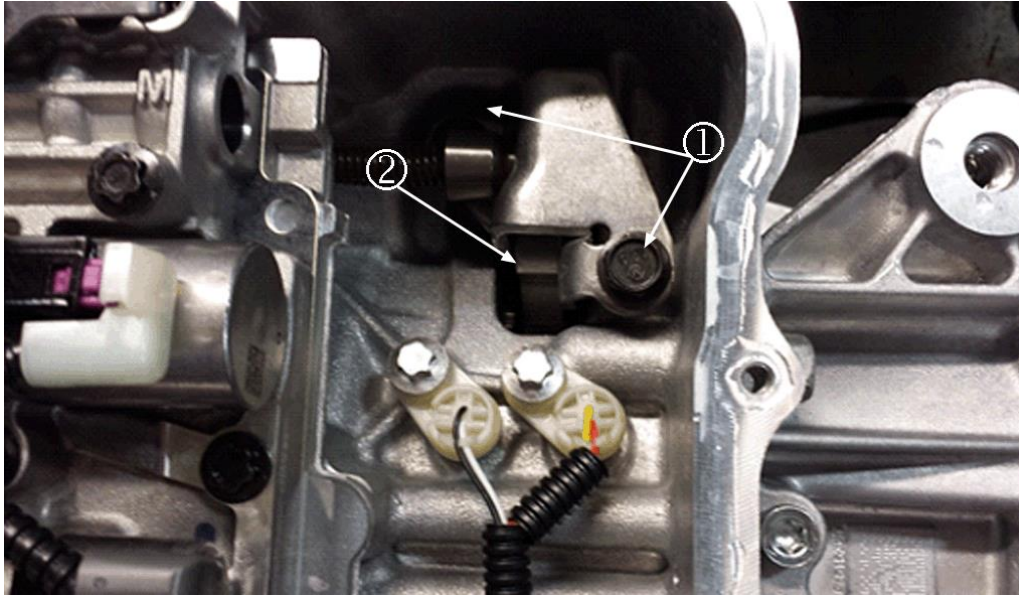

4119602

4. Remove the two park pawl actuator bracket bolts (1). Discard the bolts.
5. Move the park pawl (2) away from the output carrier assembly gear.

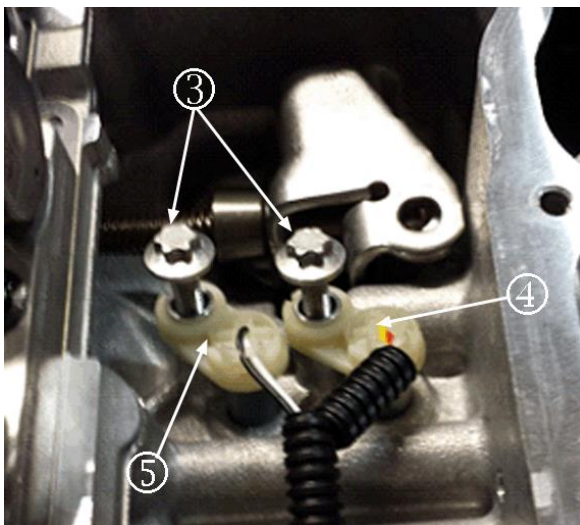

4121123

6. Using the DT-48285 Torx Plus socket, remove the two output speed sensor wiring harness bolts (3). Discard the bolts.
7. Position the transmission output speed sensor (TOSS) (4) and clutch input speed sensor (CISS) (5) out of the access holes.

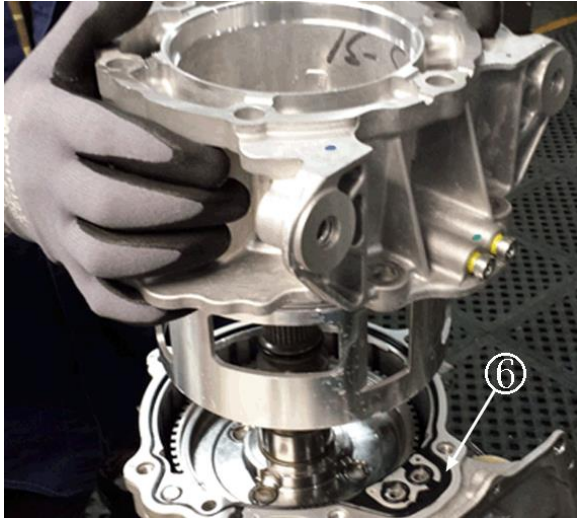

4121125

- 8. Turn the transmission vertically and remove the 6 case extension bolts.
- 9. Carefully remove the case extension assembly and extension seal (6).



4121151

- 10. Remove the output shaft bearing.



4119614

11. Remove the output shaft.



4121181

12. Remove the output sun gear thrust bearing.

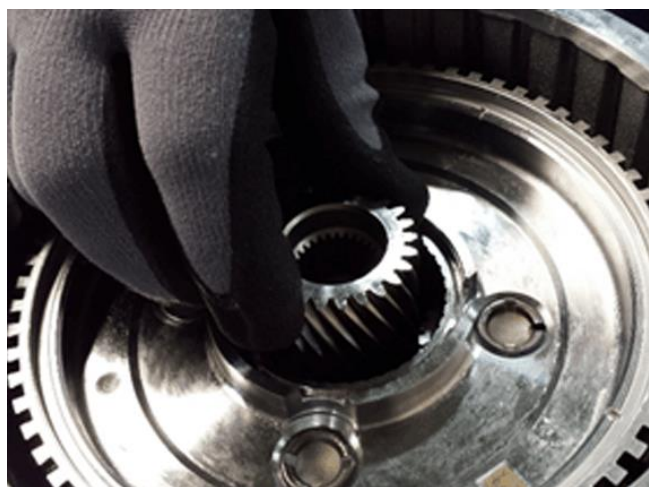

4121157

13. Remove the output sun gear.

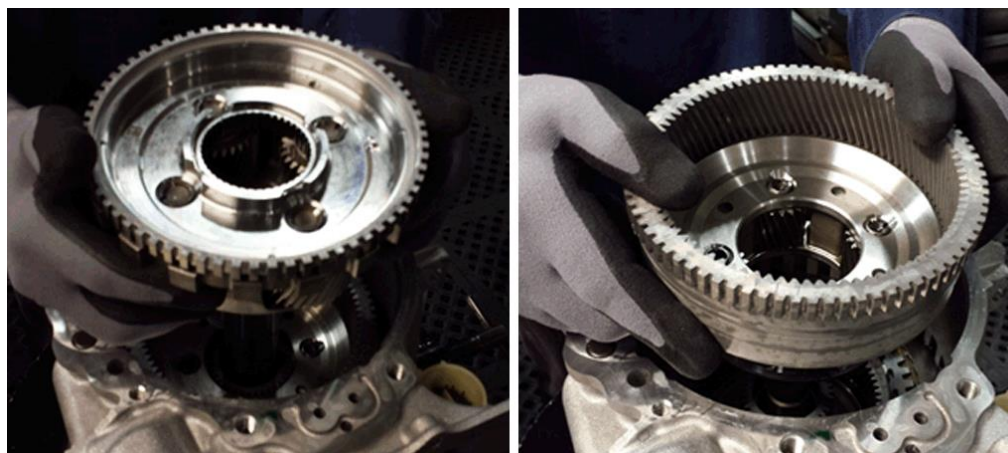

4121116

14. Remove the output carrier assembly.

15. Remove the reaction carrier assembly.

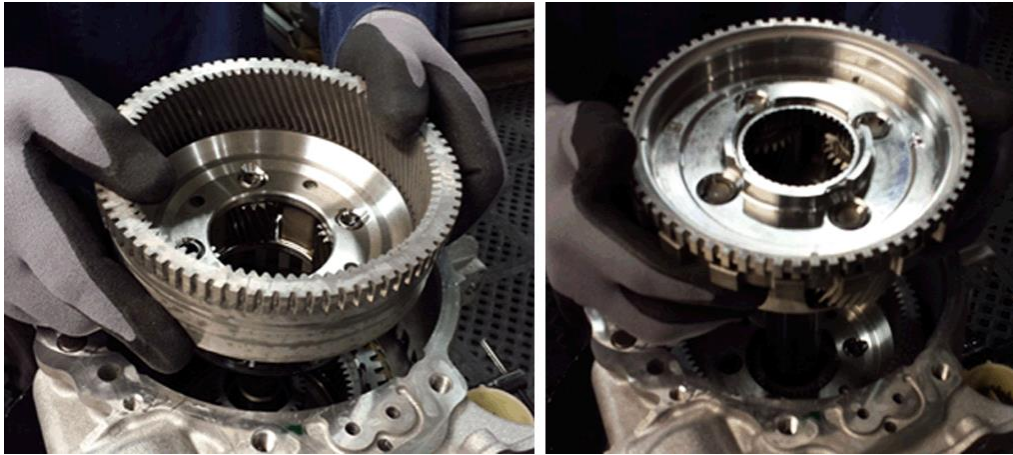

4121120

16. Install the new reaction carrier assembly.

17. Install the old output carrier assembly.

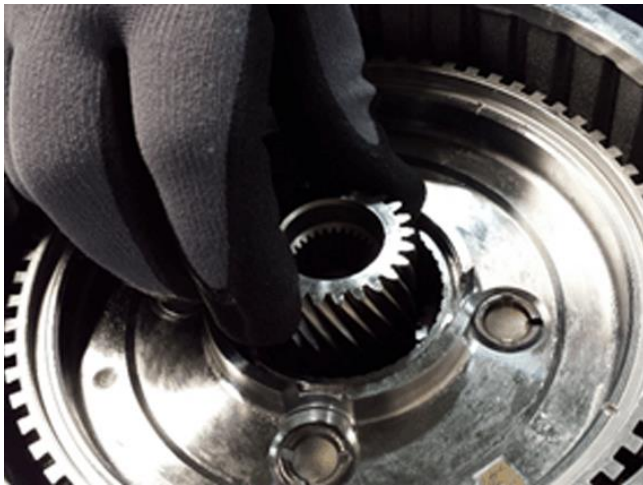

4121157

18. Install the output sun gear.



4121181

19. Install the output sun gear thrust bearing (flange side down).



4119614

20. Install the output shaft.

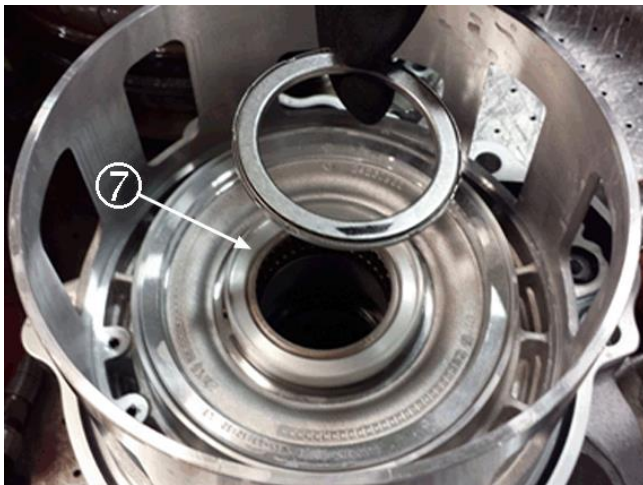

4121186

19. To hold the bearing in place during assembly, apply Kent-Moore J-36850-A Transgel Lubricant or equivalent to the underside of the output shaft bearing and insert the bearing into the case extension assembly bearing pocket (7).



4121191

20. Install the case extension seal (6).

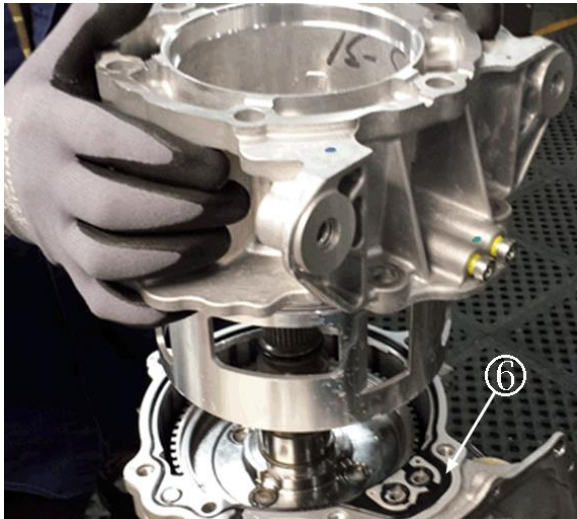

4121125

21. Ensure transmission is completely vertical and carefully install the case extension assembly.

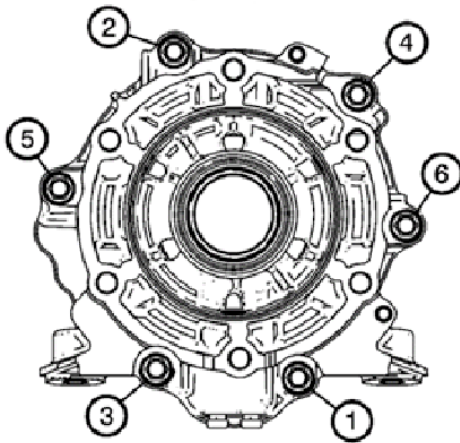

4121195

22. Install the 6 case extension bolts. Tighten the bolts in the sequence shown. Tighten the bolts a first pass to **20 Nm (15 lb ft)**. Tighten the bolts a final pass to **55 degrees**.

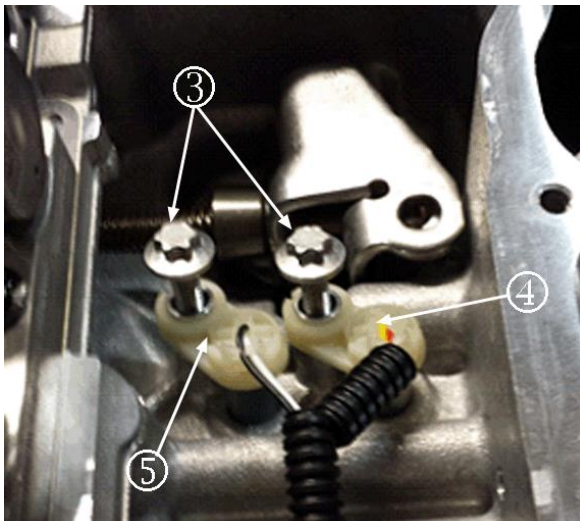

4121123

23. Turn the transmission horizontally and install the transmission output speed sensor (TOSS) (4) and clutch input speed sensor (CISS) (5) into the appropriate positions.

24. Using the DT-48285 Torx Plus socket secure the sensors using 2 new output speed sensor wiring harness bolts (3). Tighten the bolts a first pass to **4 Nm (35 lb in)**. Tighten the bolts a final pass to **45 degrees**.

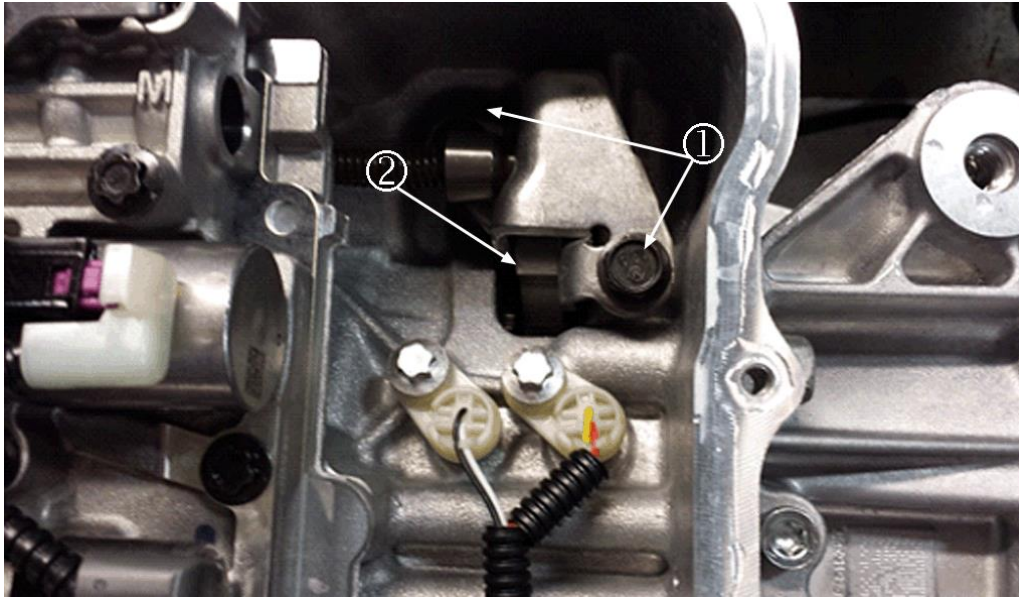

4119602

25. Properly install the park pawl into the output carrier assembly gear and secure the park pawl bracket using 2 new park pawl actuator bracket bolts. Tighten the bolts to **40 Nm (30 lb ft)**.
26. Ensure the park pawl actuator assembly is positioned correctly against the pawl.

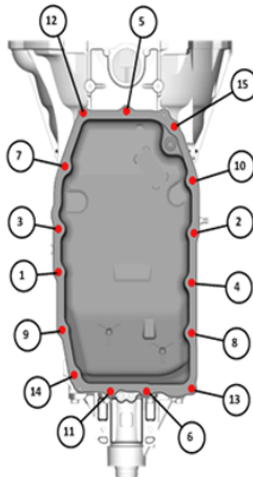

4121203

27. Install the fluid pan and gasket and secure with 15 bolts. Tighten the bolts to **10 Nm (89 lb in)** in the sequence shown.
28. Install the transmission into the vehicle. Refer to *Transmission Replacement* in SI.

WARRANTY TRANSACTION INFORMATION

Submit a transaction using the table below. All transactions should be submitted as a ZFAT transaction type, unless noted otherwise.

Labor Code	Description	Labor Time	Net Item
9101404	Drive Audit - Gear Whine Noise is NOT Present - No Further Action Required	0.5	*
9101446	Reaction Carrier Gear Noise Repair (Includes Drive Audit)		
	- Four Wheel Drive	6.7	**
	- Two Wheel Drive	5.4	**
9101516	Floor Plan Reimbursement	N/A	***

- * The amount identified in "Net Item" should represent the actual cost for the gasoline required for the drive audit, not to exceed \$3.50 USD, \$3.90 CAD.
- ** The amount identified in "Net Item" should represent the actual cost for the gasoline required for the drive audit, not to exceed \$3.50 USD, \$3.90 CAD plus the actual cost for the transgel lubricant or equivalent needed to perform the required repairs, not to exceed \$0.98 USD, \$1.20 CAD. The total amount should not exceed \$4.48 USD, \$5.10 CAD.
- *** The amount identified in "Net Item" should represent the product of the vehicle's average daily interest rate (see table below) multiplied by the actual number of days the vehicle was in dealer inventory and not available for sale because it failed the drive audit. This reimbursement is limited to the number of days from the date of the drive audit message (March 24, 2015) to the date the repair is completed and the vehicle is ready for sale (not to exceed 34 days).

Vehicle	U.S. Reimbursement Amount
Escalade	\$9.43
Escalade ESV	\$9.85
Silverado LD	\$4.95
Sierra LD	\$5.32
Yukon	\$7.28
Yukon XL	\$7.67

DEALER PROGRAM RESPONSIBILITY

Dealers must take the steps necessary to ensure that the service update correction has been made to all involved vehicles in dealer inventory before selling or dealer-trading the vehicle, but no later than April 30, 2016.



GM CUSTOMER CARE AND AFTERSALES
DCS3647
URGENT - DISTRIBUTE IMMEDIATELY

Date: May 1, 2015

Subject: 15178A – Service Update Bulletin
Transmission Gear Noise

Models: 2015 Cadillac Escalade, Escalade ESV

2015 Chevrolet Silverado LD Crew, Silverado LD Crew LTZ,
Silverado LD Ext LTZ

2015 GMC Sierra LD Crew, Sierra LD Crew Denali, Sierra LD Ext,
Yukon, Yukon Denali, Yukon XL, Yukon XL Denali

Equipped with 8-Speed Transmission (RPO M5U) and 6.2L
Engine (RPO L86)

To: All Cadillac, Chevrolet and GMC Dealers

Attention: General Manager, Service Advisor, Service Manager, Parts and
Service Director, Parts Manager, New Vehicle Sales Manager,
and Warranty Administrator

The Parts Information, Service Procedure and Warranty Transaction Information sections have been revised. Part numbers 11546930 and 11612187 have been removed. Repair steps 15, 16 ,and 17 have been modified. Floor plan reimbursement instructions have been added. Please discard all copies of bulletin 15178.

END OF MESSAGE
GM CUSTOMER CARE AND AFTERSALES