 HYUNDAI NEW THINKING. NEW POSSIBILITIES.	GROUP	NUMBER
	CAMPAIGN	15-01-015-1
Technical Service Bulletin	DATE	MODEL(S)
	JUNE 2015	GENESIS (DH)
SUBJECT: DUMMY HOUSING INSTALLATION (SERVICE CAMPAIGN TX0)		

This TSB supersedes bulletin 15-01-015 to include retail vehicles.

*** IMPORTANT**

***** Dealer Stock and Retail Vehicles *****

Dealers must perform this Service Campaign on all affected vehicles prior to customer retail delivery and whenever an affected vehicle is in the shop for any maintenance or repair.

When a vehicle arrives at the Service Department, access Hyundai Motor America's "Warranty Vehicle Information" screen via WEBDCS to identify open Campaigns.

Description: This bulletin describes the procedure to install a Dummy Housing to the passenger's seat connector on certain 15MY Genesis (DH) vehicles to seal the connection housing. In the event of water intruding into the interior cabin, an unsealed connector could result in connector pin corrosion.



Applicable Vehicles: Certain 2015 Genesis (DH)

Circulate To: General Manager, Service Manager, Parts Manager, Warranty Manager, Service Advisors, Technicians, Body Shop Manager, Fleet Repair

Parts Information:

Part Name	Part #	Comment
DUMMY HOUSING	 88570-B1200QQH	- 2 pin type - 1 EA

Warranty Information:

Model	Op. Code	Operation	Op. Time
GENESIS (DH)	40C080R1	DUMMY HOUSING INSTALLATION	0.2M/H

NOTE: Submit Claim on Campaign Claim Entry Screen

Service Procedure:

1. Move the passenger's seat all the way forward, and fold the seatback fully forward.

- A : Forward/Rearward adjustment lever
- B : Seatback angle adjustment lever

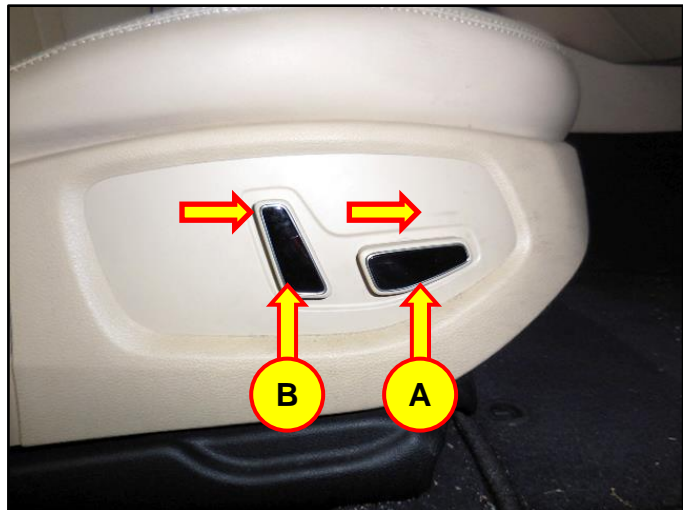

2. Locate the integration connector under the passenger's seat.



3. To release the locking mechanism, rotate the lever (C) in the direction of the arrow.

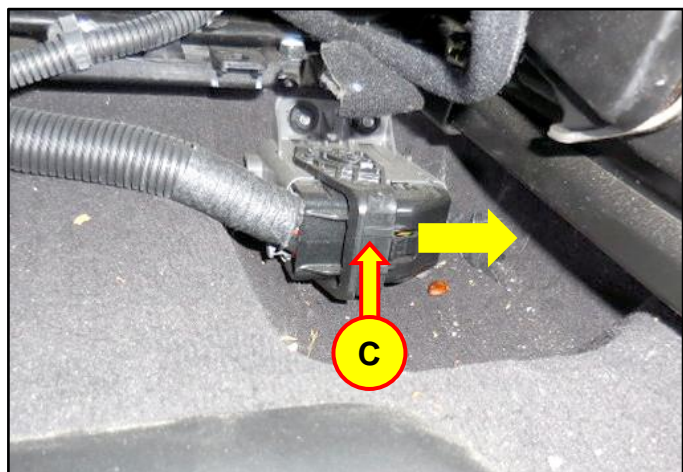

4. Disconnect the integration connector (D).

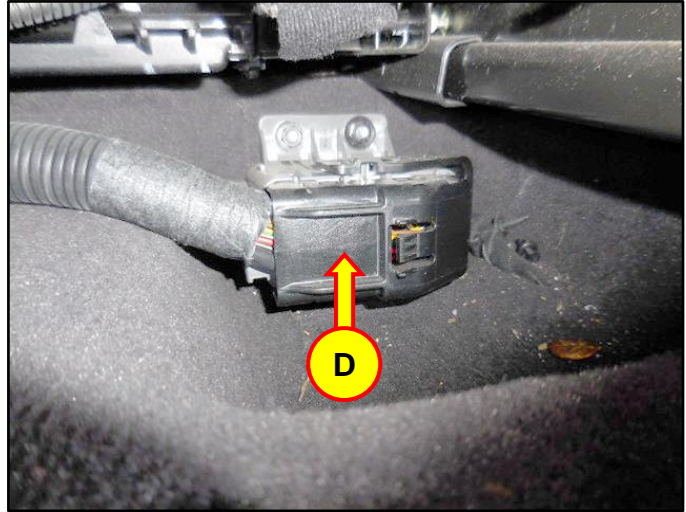

5. Using a flat head screw driver carefully remove the connector cover by releasing the locking hooks (E).

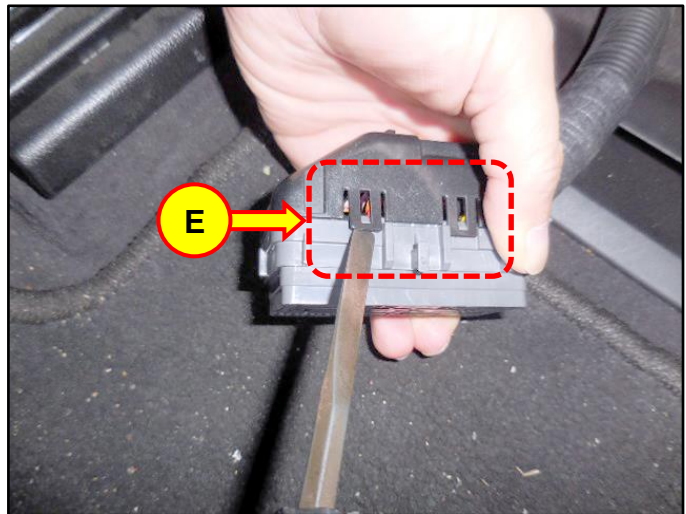

6. Install the dummy housing (F) to the connector. See below for connector diagram.

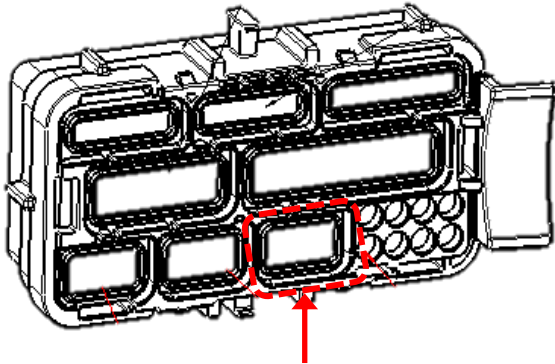

Install dummy housing here.

NOTICE

Photo to the right shows correct integration of the dummy housing with connector.

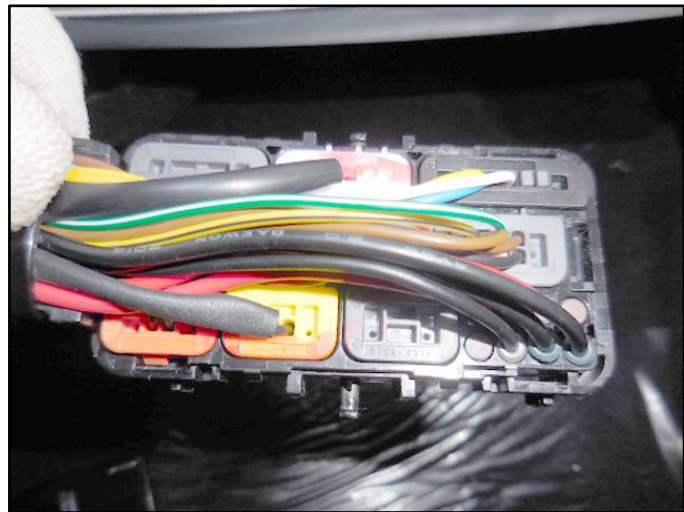
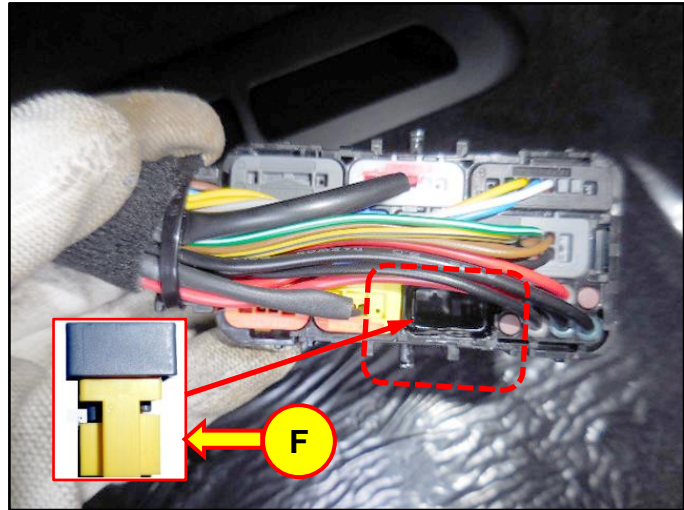

7. Reinstall the connector cover and then reconnect the integration connector.
8. Connect GDS and erase any DTC history.