



SERVICE CAMPAIGN BULLETIN

SUBJECT: SB-10056921-8103		No: SC-14-003REV	
i-MiEV UNDERCARRIAGE RUST –		DATE: April, 2015	
SERVICE CAMPAIGN – REVISED		MODEL: 2012 i-MiEV	
CIRCULATE TO:	<input checked="" type="checkbox"/> GENERAL MANAGER	<input checked="" type="checkbox"/> PARTS MANAGER	<input checked="" type="checkbox"/> TECHNICIAN
<input checked="" type="checkbox"/> SERVICE ADVISOR	<input checked="" type="checkbox"/> SERVICE MANAGER	<input checked="" type="checkbox"/> WARRANTY PROCESSOR	<input checked="" type="checkbox"/> SALES MANAGER

This bulletin supercedes SC-14-003, issued October, 2014, to clarify the repair procedures and require photos be uploaded to the PRC prior to under cover replacement. Changes are italicized and indicated by ◀.

PURPOSE

The undercarriage on certain 2012 i-MiEV vehicles, along with the bolts securing the Main Drive Lithium-ion battery under covers and non-essential ground connections, may be susceptible to rust.

This campaign bulletin instructs dealers to inspect the non-essential ground connection bolts and undercarriage. If the bolts are not *broken*, the dealer will remove any undercarriage rust, apply anti-corrosion wax to the frame, reinstall the under covers, and replace the bolts. If the bolts are *broken*, upload photos of the broken bolt to the PRC for Techline review. Once approved, the "209 – Product Support" parts restriction on the under covers are removed and the order will process. The dealer will then remove any undercarriage rust, apply anti-corrosion wax to the frame, and replace the under covers with new covers that use ground bus bars.

AFFECTED VEHICLES

2012 i-MiEV built October 28, 2011 – July 2, 2012

CUSTOMER NOTIFICATIONS

A letter will be sent to all owners of affected vehicles requesting them to bring their vehicle to a local Certified Mitsubishi Motors i-MiEV dealer to have this product improvement performed. A copy of the customer notification letter appears at the end of this bulletin.

REQUIRED OPERATIONS

- Before starting this campaign procedure, **CHECK THE WARRANTY SUPERSCREEN** to verify if the vehicle is an affected VIN for this campaign and this campaign procedure has not already been completed.
- Record the vehicle's production date. This information will be needed during the **Repair Procedure**.
- Repairs must be completed by a certified i-MiEV technician. Please ensure the Main Drive battery's charge is properly maintained while the vehicle is not being serviced.

IMPORTANT

To maximize customer satisfaction with the quality of their vehicle, affected new or used inventory vehicles should be remedied before the vehicle is delivered. Dealers must check their inventory vehicles' VINs on the Warranty Super Screen to verify whether the vehicle is involved in this service campaign.

IMPORTANT

Please ensure the Main Drive battery is fully charged prior to vehicle delivery. If the vehicle cannot be immediately remedied, the Main Drive battery should be charged while the vehicle is waiting for the product improvement. This will limit customer inconvenience and maximize customer satisfaction.

PROCESS FLOW CHART

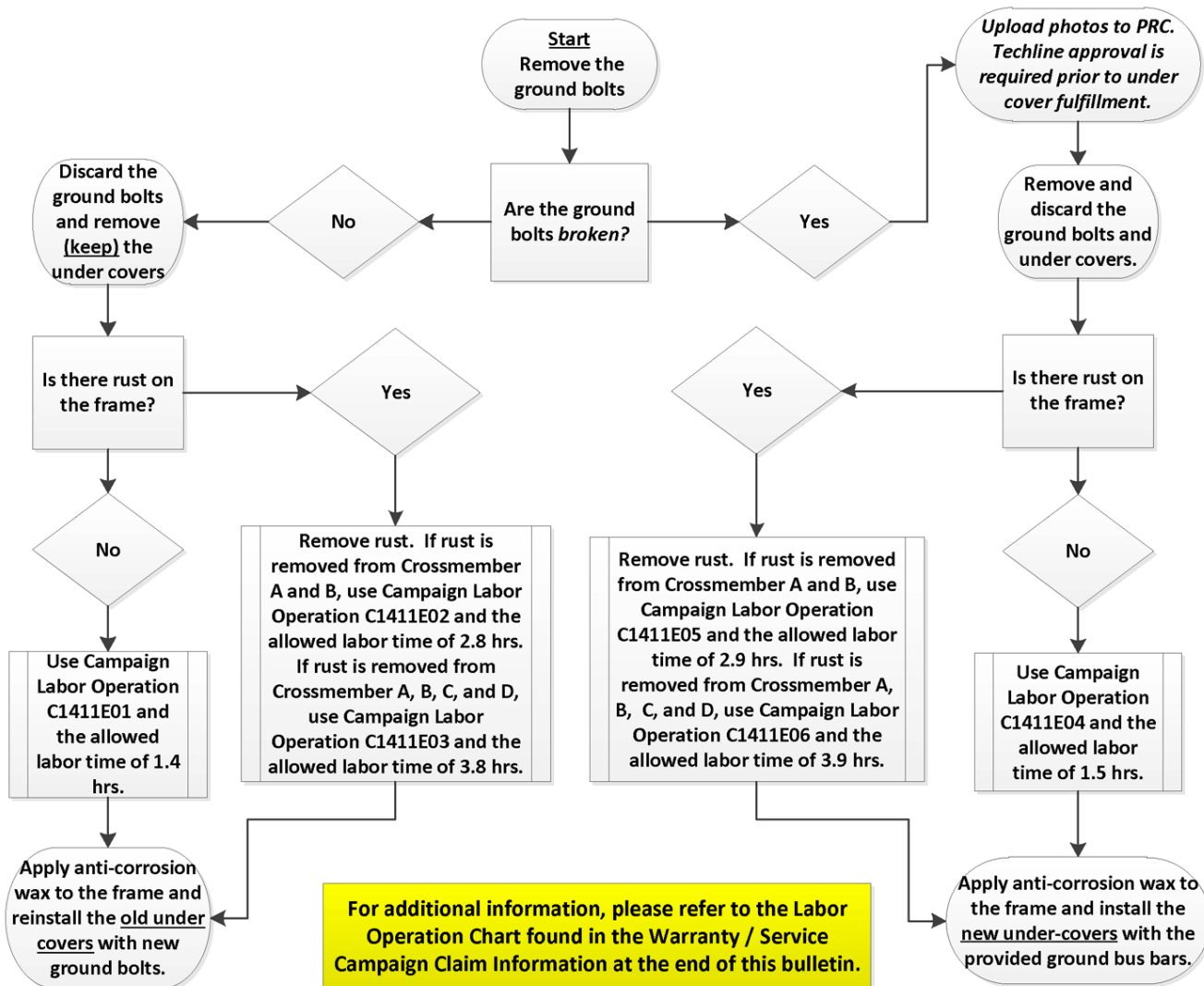

⚠ WARNING Wear safety goggles, gloves, and a face mask while performing this repair.

REPAIR PROCEDURE

1. Place the vehicle on a lift, shift the selector to PARK, set the parking brake, and turn the electric motor switch to the OFF position. Raise the vehicle.
2. Remove the front and rear plug covers (#3 and #6 – refer to the diagram below) and the non-essential ground bolts (#4 and #7 – refer to the diagram below).
3. Remove the front under cover (#5 – refer to the diagram below), then remove the rear under cover (#8 – refer to the diagram below).

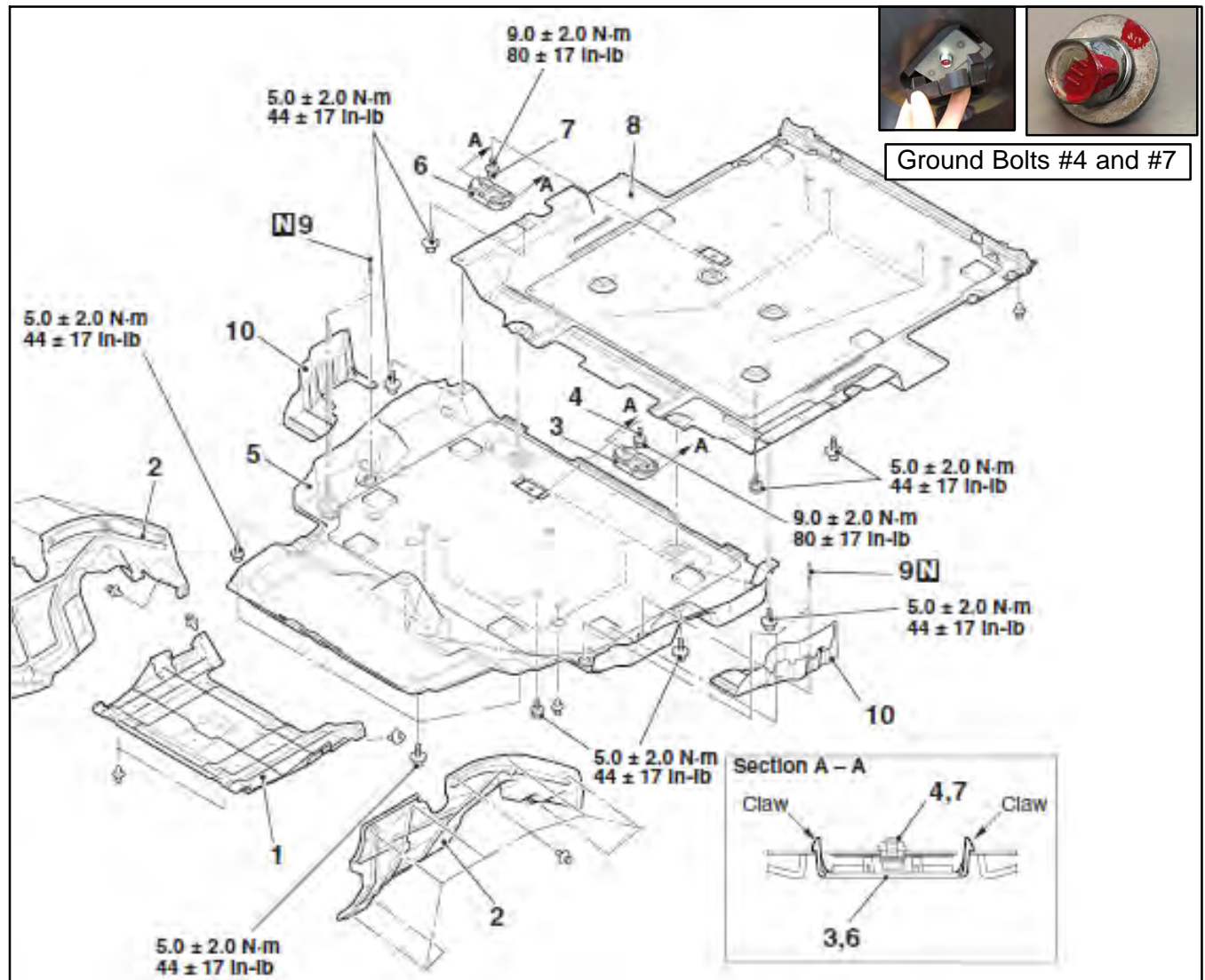

4. If the non-essential ground bolts are *broken*, upload photos of the broken bolt to the PRC. Once approved by Techline, the "209 - Product Support" parts restriction on the under covers are removed and the order will process. Skip Step 5 and go to Step 6.

5. If the non-essential ground bolts are *not broken*:
 - a. Use a high pressure air hose to remove dirt from the under covers.
 - b. Remove any rust on the under covers with a wire brush until the surface is smooth.

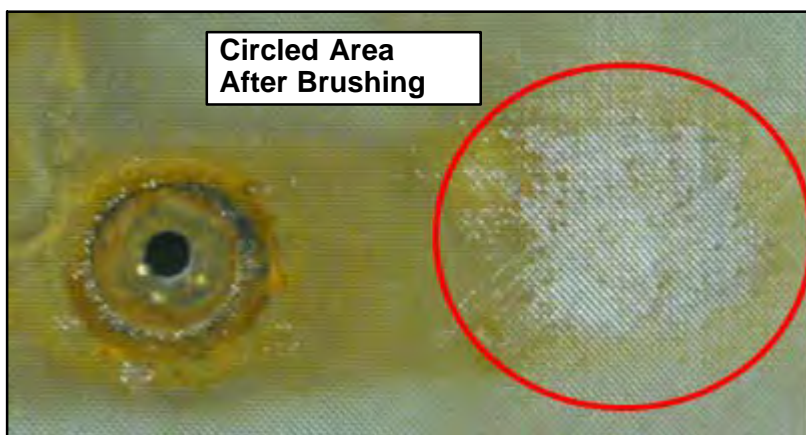
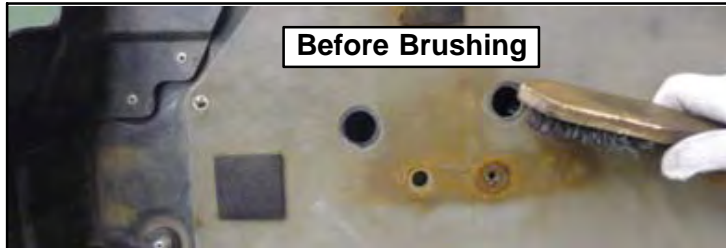

6. Inspect Crossmember A. If rust is present, remove 50% or more of the rust using hand tools such as a wire brush, flat head screwdriver and a scraper.

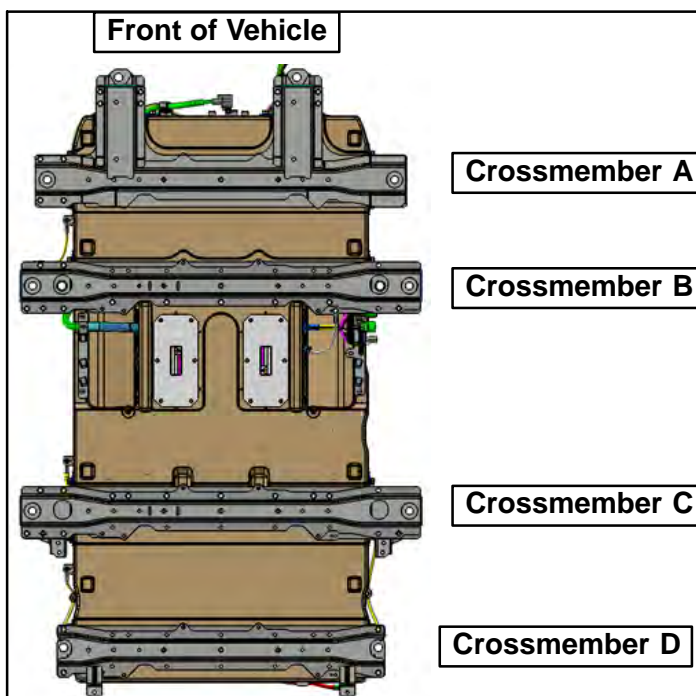



7. Repeat Step 6 for Crossmember B, C, and D and remove rust if required.

8. Install (9) washers to the frame with super glue or epoxy in the attachment points indicated below.

IMPORTANT Apply pressure to each washer for at least 1 minute to ensure proper bonding.

IMPORTANT Ensure rust is removed from the indicated attachment points before washer adhesion.

IMPORTANT Ensure the washers and frame are clean before installation.

IMPORTANT Do not cover the bolt holes with the washer.

IMPORTANT Do not apply super glue or epoxy to the bolt hole threads.

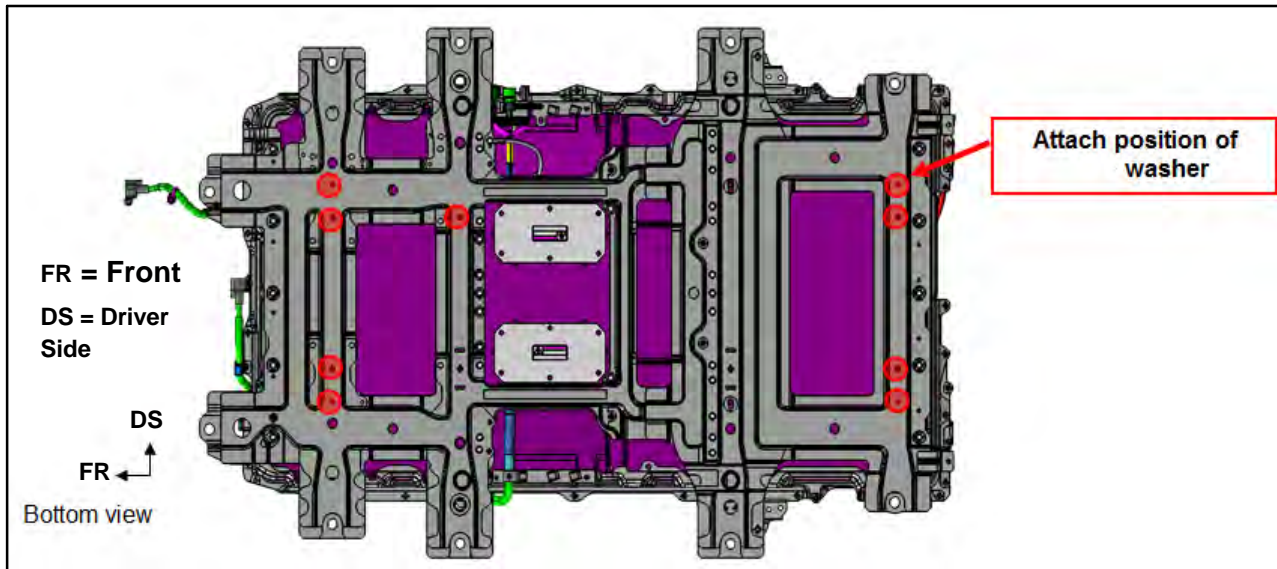

NOTE: Apply adhesives to each washer as shown in the left illustration.

9. To prevent anti-corrosion wax from contacting the resin undercarriage components (harness, battery tray, etc...), mask the indicated areas below with shipping/packaging paper or plastic covers.

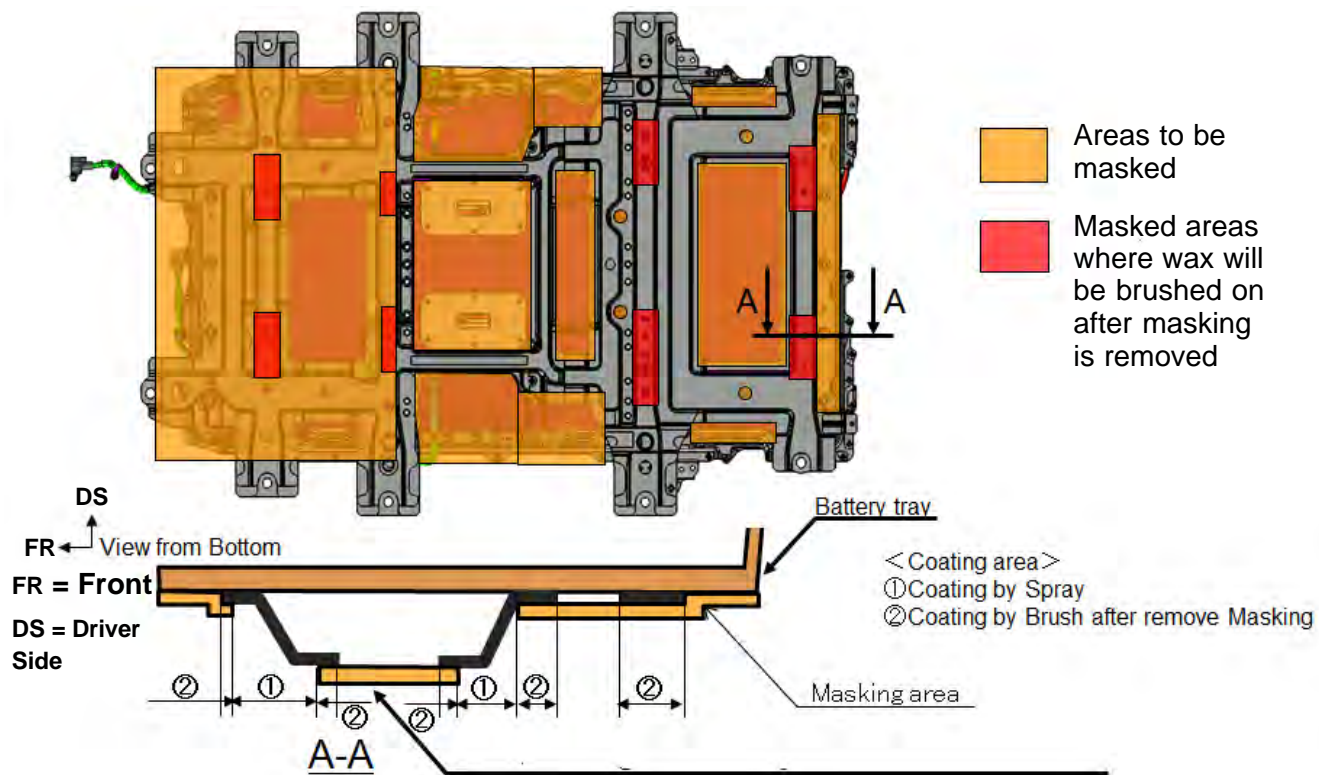

Without proper masking, wax may adhere to the battery tray through the holes

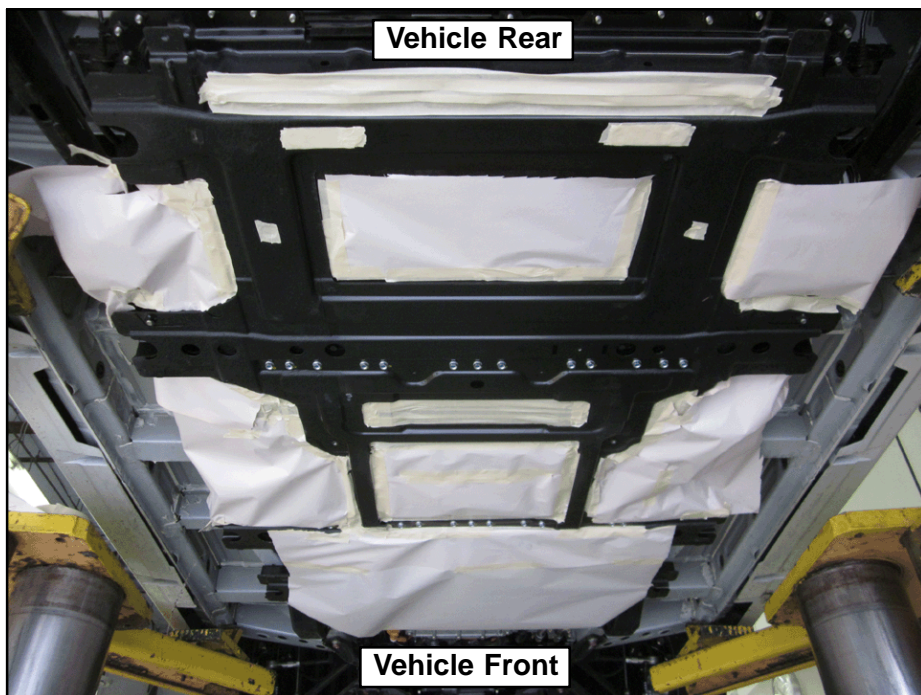

10. In one continuous motion, spray anti-corrosion wax on the frame in the areas indicated with **red arrows** shown below. After the initial application, immediately apply 2-3 more coatings. The anti-corrosion wax coating must be thicker than the existing frame undercoating.

IMPORTANT Dealers in Oregon and Washington must use Dinitrol anti-corrosion wax Part No. 1117901 and anti-corrosion wax applicator Part No. 1700700. Dealers in all other states must use Three Bond anti-corrosion wax Part No. MZ320725.

IMPORTANT If Dinitrol applicator Part No. 1700700 is required, set shop air to 29-58 psi. Clean after every use with mineral spirits or similar solvent.

CAUTION Familiarize yourself with the DANGER, PRECAUTIONS, and WARNING labels on the can before applying the anti-corrosion wax.

WARNING Do not apply anti-corrosion wax to the high voltage wiring or resin components.

NOTE: Ensure the area is clean before applying anti-corrosion wax.

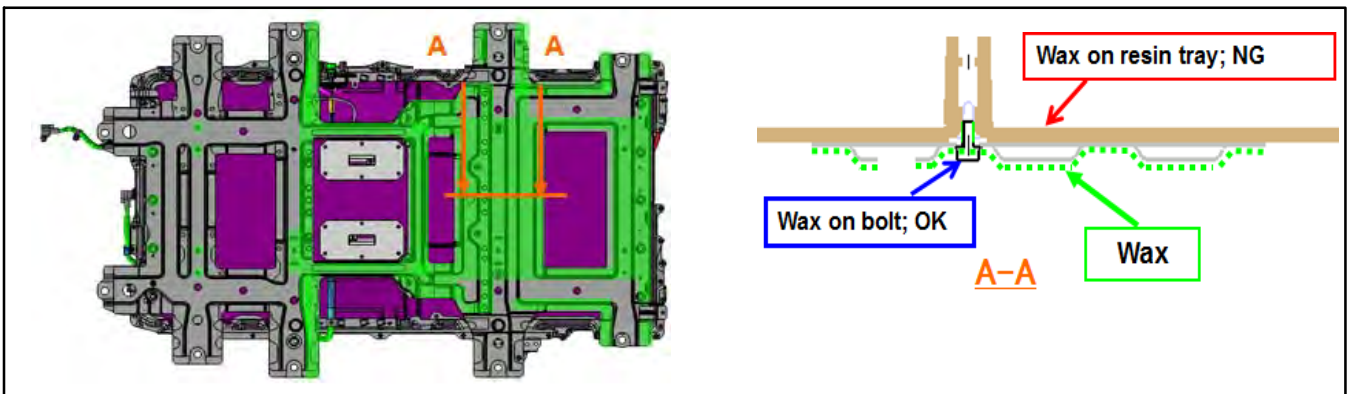
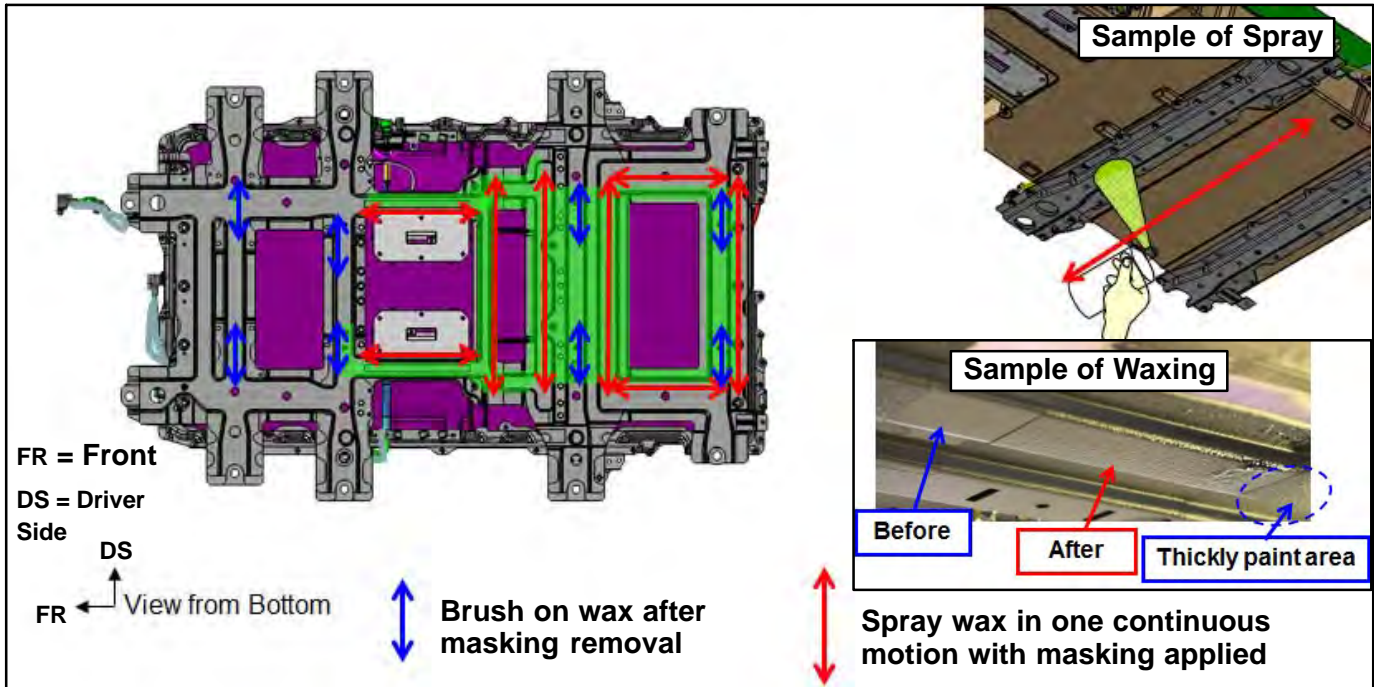

CAUTION To avoid applying anti-corrosion wax to the resin components, and the bolt and clip mounting locations, spray the wax onto a brush and apply to the indicated areas.

11. Remove the masking. Spray anti-corrosion wax onto a brush and brush areas indicated with **blue arrows** shown in the illustration in Step 10.

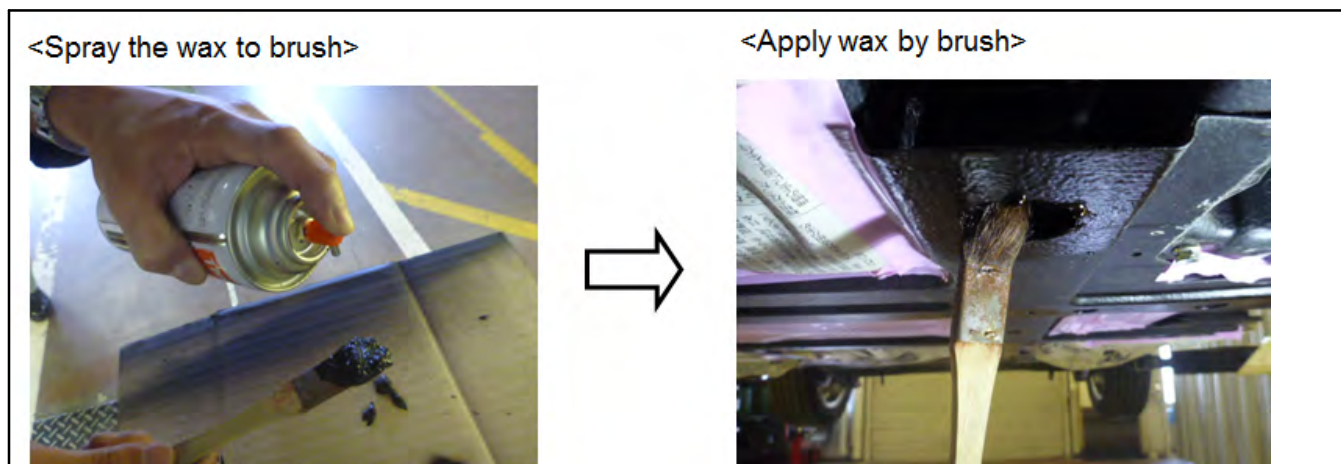

NOTE: In the indicated area below, the method of brushing depends on the vehicle's build date.

- For vehicles built in October 2011 and earlier, apply wax according to Figure A.
- For vehicles built in November 2011 and after, apply wax according to Figure B.

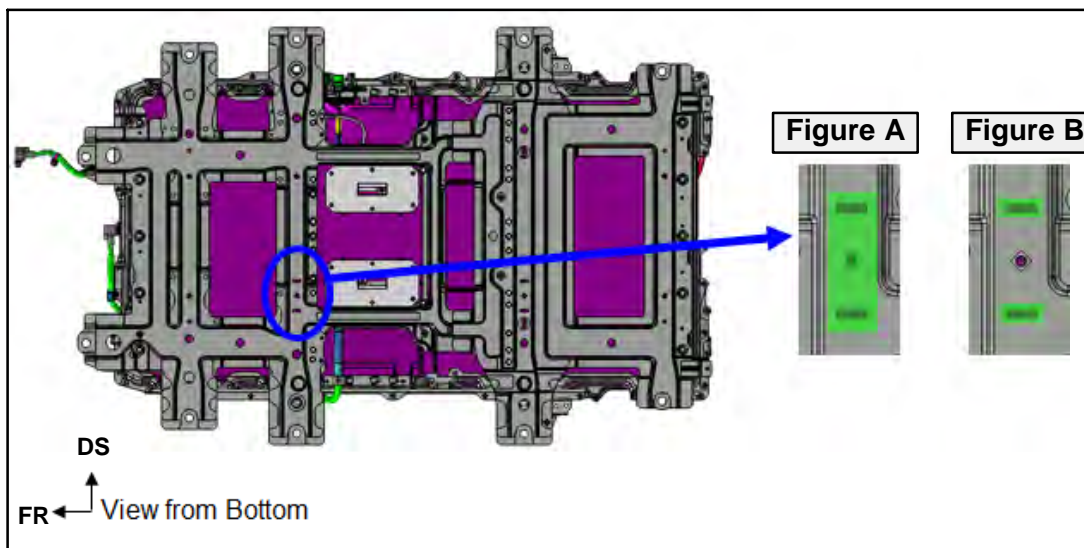

12. Allow 30 minutes for the anti-corrosion wax to dry.

13. If the ground bolts from Step 2 are not *broken*, reinstall the old under covers (**do not reinstall the plug covers**) and replace the ground bolts with new ones. Torque ground bolts to 80 ± 17 in-lb (9 ± 2 N-m) and the under cover bolts to 44 ± 17 in-lb (5 ± 2 N-m). **Proceed directly to the Continuity Check Procedure section below.**

If the ground bolts from Step 2 are *broken*, and the order for the under covers is approved by Techline, proceed to Step 14.

14. Discard the old under covers. Install the bus bar assembly to the new rear under cover as shown, then install the under cover to the vehicle.

NOTE: Do not install the plug covers until the **Continuity Check Procedure** has been completed.

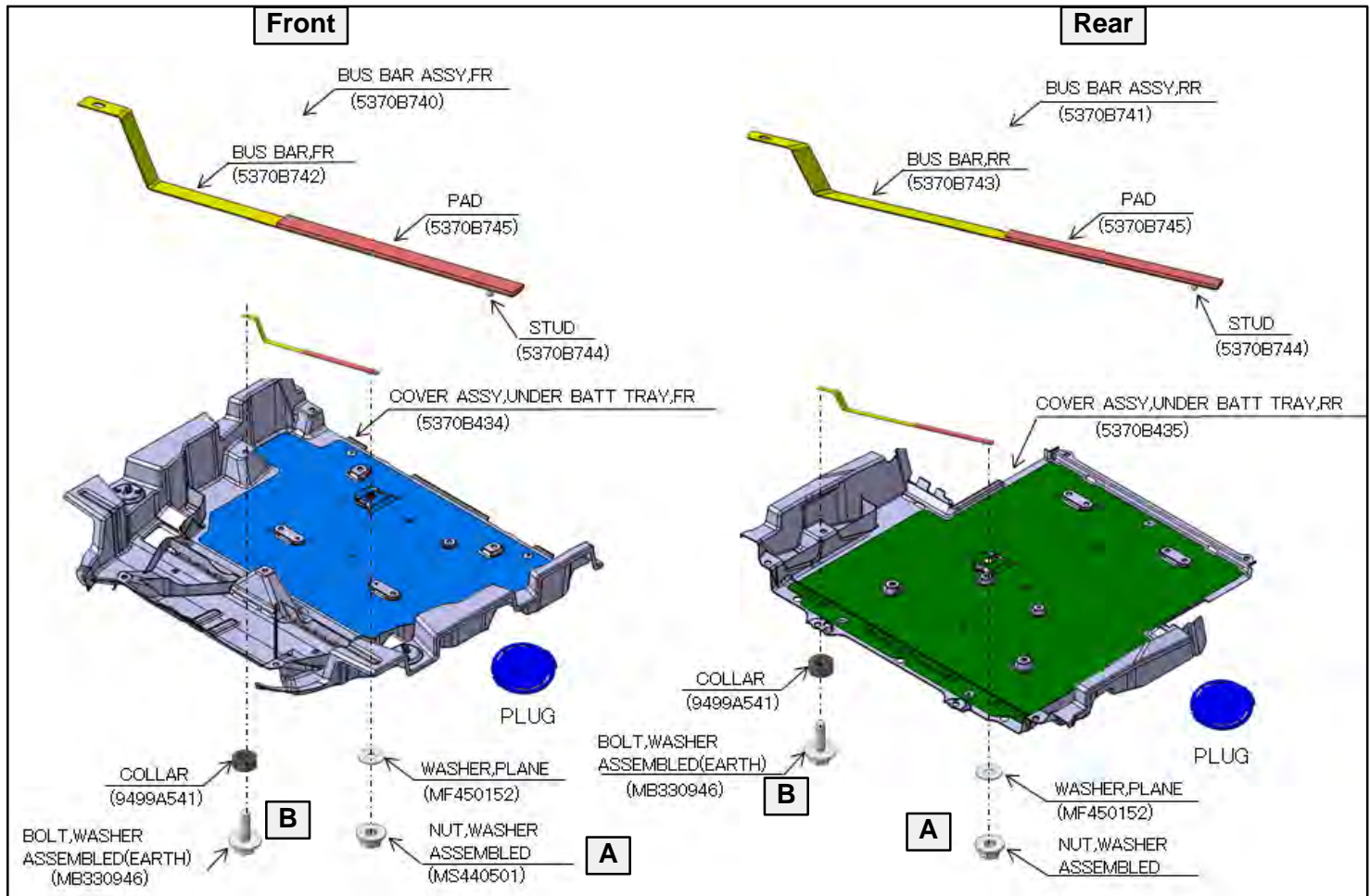

- Install, but do not torque, the ground nut (A).
- Install, but do not torque, the frame bolt (B).
- Torque ground nut (A) to 17.5–35 in–lbs (2–4 N–m).
- Torque frame bolt (B) to 26.5 – 62 in–lbs (3–7 N–m).

15. Repeat Step 14 for the new front under cover, and ensure the driver side and passenger side mounting tabs are properly mounted into the frame.

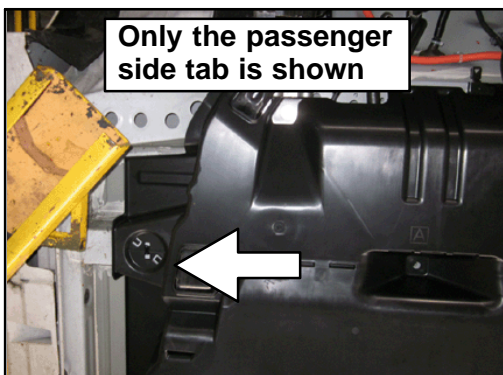

16. New under covers with ground bus bars installed.

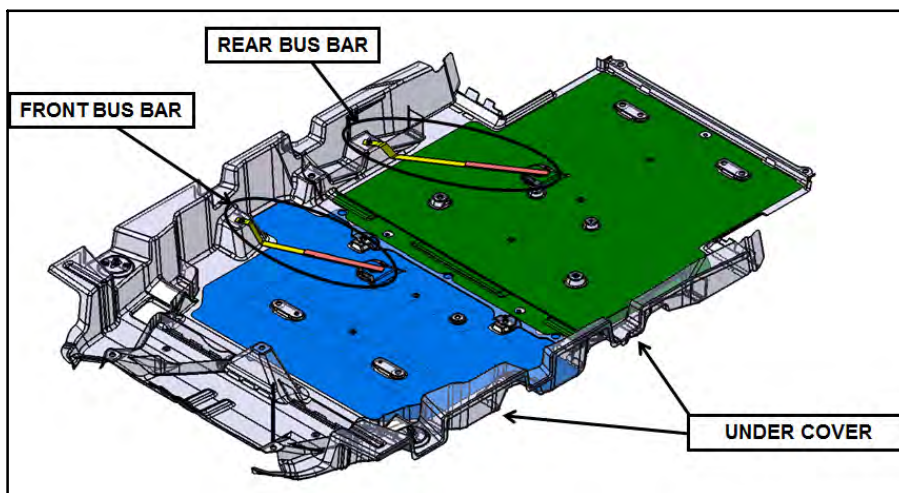

CONTINUITY CHECK PROCEDURE

1. Use an ohmmeter and perform a continuity check between the two ground locations as shown below. The value should be less than 2Ω . If the value is more than 2Ω , ensure the ground bus bars or ground bolts were properly installed and measure the resistance again.

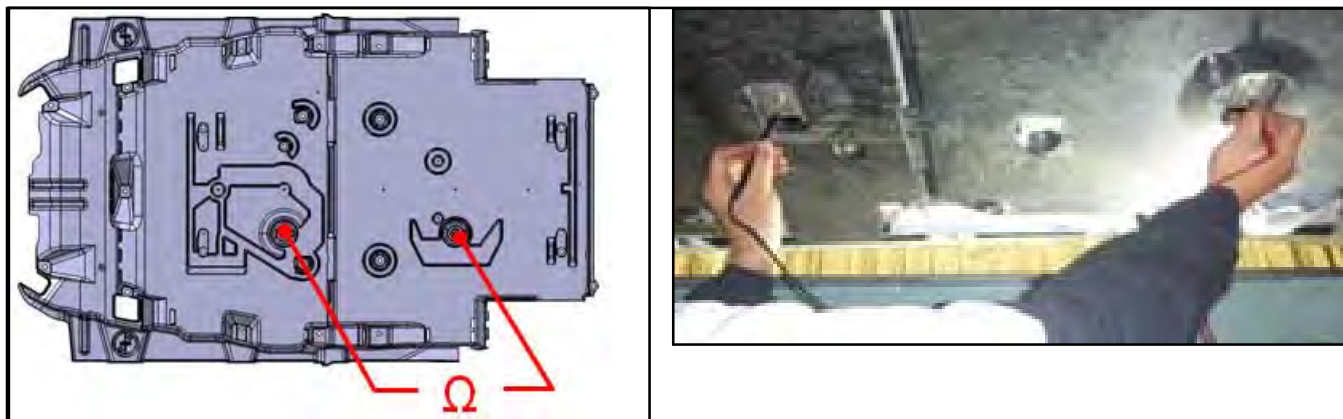

2. Install the under cover plug covers.

PARTS INFORMATION

Use the genuine Mitsubishi Parts listed below:

Description	Part Number	Qty
Kit, Under Battery Bolt	5370B704	1
Kit, Front Under Battery Cover – “209-Product Support” Parts Restriction	5370B760	1*
Kit, Rear Under Battery Cover – “209-Product Support” Parts Restriction	5370B761	1*
Anti-Corrosion Wax, Three Bond	MZ320725	1**
Anti-Corrosion Wax, Dinitrol	1117901	1***
Applicator for Dinitrol Anti-Corrosion Wax	1700700	1***

*Required if ground bolts are *broken*. *Techline approval required to process order*

For dealers in states other than Oregon and Washington *For dealers in Oregon and Washington

For additional information on safety, use, handling, and disposal of the anti-corrosive wax, please reference the Material Safety Data Sheet (MSDS) by inputting the Part Number in the [MDL > Parts > Parts Information > Hazardous Materials > Request Safety Data Sheets \(SDS\)](#).

WARRANTY INFORMATION

There are 6 repair scenarios

#	Campaign OP#	Labor Time	Repair Description	Part Kit Number(s)	Wax Part #
1	C1411E01	1.4 hrs	<i>Ground bolts not broken</i> , remove under covers, no rust found on crossmembers, apply wax, reinstall under covers with new ground bolts.	5370B704	1117901 – OR & WA
					MZ320725 – Other 48 States
2	C1411E02	2.8 hrs	<i>Ground bolts not broken</i> , remove under covers, rust found on crossmembers A and B, remove rust on crossmembers A and B, apply wax, reinstall under covers with new ground bolts.	5370B704	1117901 – OR & WA
					MZ320725 – Other 48 States
3	C1411E03	3.8 hrs	<i>Ground bolts not broken</i> , remove under covers, rust found on crossmembers A, B, C, and D, remove rust on crossmembers A, B, C, and D, apply wax, reinstall under covers with new ground bolts.	5370B704	1117901 – OR & WA
					MZ320725 – Other 48 States
4	C1411E04	1.5 hrs	<i>Ground bolts broken</i> , remove under covers, no rust found on crossmembers, apply wax, install new under covers with new ground bus bars.	5370B704	1117901 – OR & WA
				5370B760	MZ320725 – Other 48 States
				5370B761	
5	C1411E05	2.9 hrs	<i>Ground bolts broken</i> , remove under covers, rust found on on crossmembers A and B, remove rust on crossmembers A and B, apply wax, install new under covers with new ground bus bars.	5370B704	1117901 – OR & WA
				5370B760	MZ320725 – Other 48 States
				5370B761	
6	C1411E06	3.9 hrs	<i>Ground bolts broken</i> , remove under covers, rust found on on crossmembers A, B, C, and D, remove rust on crossmembers A, B, C, and D, apply wax, install new under covers with new ground bus bars.	5370B704	1117901 – OR & WA
				5370B760	MZ320725 – Other 48 States
				5370B761	



WARRANTY / RECALL CAMPAIGN CLAIM INFORMATION

Enter all claims as claim type 'C' – Recall/Campaign Claims

Please follow the campaign instructions when entering each claim in order to select the applicable operation code that correctly matches up with the work that was actually performed. A claim example is provided below.

Certain 2012 MY i-MiEV Models

Required Operation to be performed

Labor Operation Labor Time
(See Scenario Chart)

- 2012MY i-MiEV models undercarriage rust

Claim Header Section:

**Service Warranty
Warranty Claim**

Claim Entry Vehicle Information

Campaign Information

Campaign Operation No: C1411E__

Miles/Km: 15500

VIN: JA.....

Service Technician: [] Emp No: [] Service Advisor: [] Emp No: []

Spec Value * [] Duplicate Recall *

Dealer: 99320 Ref No: [] VIN: []

Claim No: [] Adj: [] Claim Status: Incomplete Model and Year: []

Save & Continue Main Menu

Enter in the first 6 characters of this campaign labor operation: **C1411E.**

This campaign is for the possible undercarriage rust on certain 2012MY i-MiEVs.

Check the Open Campaign area of the Superscreen each time to be certain of a vehicle's eligibility. Only VINs showing **C1411E** as open are eligible.

After entering the required customer data, vehicle information, selecting the applicable repair scenario performed (please note there are 6 possible repair scenarios for this campaign), and then hitting the "Save and Continue" button will automatically fill-in several fields.

CAMPAIGN INFORMATION		C1411E - 6 Possible Repair Scenarios	
Campaign Operation No	C1411E	Repair Performance	
Miles / KM	15,500	Repair Order No	EX12345
VIN	JA3215H1XCU013185	Repair Date	10 / 30 / 2014
	2012MY IMiEV Under Carriage Rust	Out	10 / 30 / 2014

Labor and Parts:

There are 6 possible repair scenarios. Refer to the related RO to determine what repair was actually performed and what parts were used. You may only claim the labor and parts associated with the one specific repair scenario performed. Refer to the chart below for specifics.

NOTE: For the required wax, dealers in Oregon and Washington MUST use Part Number 1117901 in the repair. All dealers in all other states may only use wax MZ320725. Wax will be reimbursed on a per vehicle basis (one can of P/N 1117901 does 4 vehicles, one can of P/N MZ320725 does 2 vehicles).

Campaign Repair Scenarios					
#	Campaign OP#	Labor Time	Repair Description	Part Kit Number(s)	Wax Part #
1	C1411E01	1.4 hrs	<i>Ground bolts not broken</i> , remove under covers, no rust found on crossmembers, apply wax, reinstall under covers with new ground bolts.	5370B704	1117901 – OR & WA
					MZ320725 – Other 48 States
2	C1411E02	2.8 hrs	<i>Ground bolts not broken</i> , remove under covers, rust found on crossmembers A and B, remove rust on crossmembers A and B, apply wax, reinstall under covers with new ground bolts.	5370B704	1117901 – OR & WA
					MZ320725 – Other 48 States
3	C1411E03	3.8 hrs	<i>Ground bolts not broken</i> , remove under covers, rust found on crossmembers A, B, C, and D, remove rust on crossmembers A, B, C, and D, apply wax, reinstall under covers with new ground bolts.	5370B704	1117901 – OR & WA
					MZ320725 – Other 48 States
4	C1411E04	1.5 hrs	<i>Ground bolts broken</i> , remove under covers, no rust found on crossmembers, apply wax, install new under covers with new ground bus bars.	5370B704	1117901 – OR & WA
				5370B760	MZ320725 – Other 48 States
				5370B761	
5	C1411E05	2.9 hrs	<i>Ground bolts broken</i> , remove under covers, rust found on on crossmembers A and B, remove rust on crossmembers A and B, apply wax, install new under covers with new ground bus bars.	5370B704	1117901 – OR & WA
				5370B760	MZ320725 – Other 48 States
				5370B761	
6	C1411E06	3.9 hrs	<i>Ground bolts broken</i> , remove under covers, rust found on on crossmembers A, B, C, and D, remove rust on crossmembers A, B, C, and D, apply wax, install new under covers with new ground bus bars.	5370B704	1117901 – OR & WA
				5370B760	MZ320725 – Other 48 States
				5370B761	

Rental Cars:

If there is a need to provide the owner with a rental car, claims the applicable charges in this section of the claim on the lower portion of the labor entry screen.

Select	Labor Operation	Labor Operation Description		Amount
<input type="checkbox"/>	SHO	SPECIAL HANDLING ORDER	SHO Parts Order	
<input type="checkbox"/>	RENTACAR	RENTAL CAR CHARGES	Days Reason <small>(Select date)</small> Rental Company Invoice Number	
<input type="checkbox"/>	95300040	FREIGHT CHARGES	Freight Company Invoice Number	
<input type="checkbox"/>	95200040	TOWING CHARGES	Towing Company Invoice Number	

Replaced Parts Retention:

Retain all replaced parts for the standard parts retention holding period of 30 days past the end of month claim statement where the claim was shown as paid. Replaced parts may be requested back.



Mitsubishi Motors North America, Inc.
6400 Katella Avenue
Cypress, CA 90630
Telephone: 714-372-6000
www.mitsubishicars.com

AFFECTED VEHICLES
MODEL: 2012 i-MiEV

This notice applies to your vehicle, _____.

Date: October, 2014

Re: Customer Satisfaction Campaign SC-14-003

Dear Mitsubishi Owner,

Mitsubishi Motors always strives to build vehicles with the highest level of quality, and continuously improve that quality with every vehicle built. To help assure continued satisfaction with your Mitsubishi vehicle, we are recommending that the following product improvement be performed on certain 2012 i-MiEV vehicles built between October 28, 2011 and May 28, 2012.

Recommended Product Improvement:

The undercarriage on certain 2012 i-MiEV vehicles, along with the bolts securing the Main Drive Lithium-ion battery under covers and non-essential ground connections, may be susceptible to rust.

What your dealer will do:

Your local certified i-MiEV Mitsubishi dealer will inspect the non-essential ground connection bolts and under covers. If the bolts are not rusted or damaged, the dealer will remove any undercarriage rust, apply anti-corrosion wax to the frame, reinstall the under covers, and replace the bolts. If the bolts are rusted or damaged, the dealer will remove any undercarriage rust, apply anti-corrosion wax to the frame, and replace the under covers with new covers that use ground bus bars. These services will be provided **free of charge**. Depending on operation, this repair will take approximately **1.5 to 4.0** hours to complete. However, the dealer may need your vehicle for a longer period of time due to scheduling. Every effort will be made to minimize your inconvenience.

What you should do:

Please contact your local certified i-MiEV Mitsubishi dealership to schedule an appointment. Although not required, it is recommended to bring this letter when you take your vehicle into the dealership.

If you have any questions regarding this customer satisfaction campaign, please contact us:

Mitsubishi Customer Relations Department
P.O. Box 6400
Cypress, CA 90630-0064
Phone 1-888-648-7820
Hours: Monday – Friday 7 a.m. – 4 p.m. Pacific Time

If you have already encountered a problem with undercarriage rust and had repairs completed as a result of this specific condition and have paid for the repair, you may send your original repair order or invoice, **and** original receipt/proof of payment to the following address for reimbursement consideration:

Mitsubishi Customer Relations Department, P.O. Box 6400, Cypress, CA 90630-0064

We appreciate your prompt attention to this matter, and apologize for any inconvenience.

Sincerely,

Mitsubishi Motors North America, Inc.

C1411E