



Countries:	RUSSIA, AUSTRALIA, CANADA, TAIWAN, UNITED STATES, MEXICO, GUAM, KOREA, SOUTH KOREA, NEW ZEALAND	Document ID:	IK1900240
Availability:	ISIS, FleetISIS	Revision:	5
Major System:	ACCESSORIES	Created:	12/23/2014
Current Language:	English	Last Modified:	7/24/2015
Other Languages:	NONE	Author:	Kevin Kochanek
Viewed:	4763		

[Less Info](#)

Hide Details

Coding Information

Copy Link 	Copy Relative Link 	Bookmark View My Bookmarks	Add to Favorites 	Print 	Provide Feedback 	Helpful 21	Not Helpful 3
----------------------	-------------------------------	--	-----------------------------	------------------	-----------------------------	--------------------------	-----------------------------

Title: Pressure Transducer (PT) Switch Install

Applies To: ProStar / LoneStar 2012 -Current

CHANGE LOG

- 04/23/2015 - Initial Article Release
- 05/04/2015 - Added ISX to LoneStar parts kit
- 05/12/2015 - Added Link to A/C Refrigerant and Oil Capacities Article. Added E-Fix Column to Feature Code Table
- 07/07/2015 - Made visible for fleets to view, updated SRTs to reflect N13 engines
- 07/24/2015 - Fixed article coding...again.

DESCRIPTION

This document will guide the user through the necessary steps to install the Pressure Transducer (PT) Switch Conversion Kit into the 2012 - Current ProStar® (01-39) and LoneStar® .

SYMPTOMS

Diagnostic Trouble Codes & Dashboard Indicator Lights:

DTC/Light	Description
Not Applicable	Not Applicable

Customer Observations or Concerns:

Failures to refrigerant portion of the A/C system in lower charge / no charge conditions.

SPECIAL TOOL(s) / SOFTWARE

Tool Description	Tool Number	Comments	Instructions
A/C Machine	34988 or 980C-NAV	NA	NA
EZ-Tech®	NA	NA	NA

SERVICE PARTS INFORMATION

Kit Description	Application	Part Number	Quantity Required
Kit, Pressure Transducer Switch Conversion	ProStar 113 BBC 2010 Sleeper		

		2514360C91	1
Kit, Pressure Transducer Switch Conversion	ProStar 122 BBC 2010 Sleeper	2514361C91	1
Kit, Pressure Transducer Switch Conversion	ProStar 122 BBC 2013 ISX Sleeper	2514362C91	1
Kit, Pressure Transducer Switch Conversion	LoneStar 122 BBC 2013 Sleeper w/ISX	2514363C91	1
Kit, Pressure Transducer Switch Conversion	ProStar 113 BBC Day Cab	2514364C91	1
Kit, Pressure Transducer Switch Conversion	ProStar 122 BBC Day Cab	2514365C91	1
Kit, Pressure Transducer Switch Conversion	ProStar 122 BBC 2013 Day Cab w/ ISX	2514366C91	1
Kit, Pressure Transducer Switch Conversion	LoneStar 122 BBC 2013 Day Cab w/ ISX	2514367C91	1

DIAGNOSTIC STEP(s)

For Diagnostic Procedures, refer to [IK1900228](#).

WARNINGS / CAUTIONS

WARNING:

To prevent property damage, personal injury, and / or death, park vehicle on hard flat surface, turn the engine off, set the parking brake, and install wheel chocks to prevent the vehicle from moving in either direction

WARNING:

To prevent personal injury and / or death, always wear safe eye protection when performing vehicle maintenance.

WARNING:

To prevent property damage, personal injury and / or death, disconnect the main negative battery terminal before removing or installing any electrical components.

WARNING:

To prevent property damage, personal injury and / or death, allow engine to cool before removing components.

**WARNING:**

To prevent property damage, personal injury and / or death, never put any part of your body beneath a raised hood unless the hood is all the way forward in its range of motion and is fully settled in the over center position.

REPAIR STEP(s)**PROCEDURE:****NOTE:**

Graphics depicted in this procedure are shown on an N13 equipped ProStar[®] 122 vehicle. All procedural steps should be considered typical except where noted.

NOTE:

This procedure requires use of an A/C machine.



0000366621

Figure 1: A/C Machine.

1. Bring vehicle into shop and park on flat surface.
2. Shift transmission to Park or Neutral, set parking brake, and install wheel chocks.
3. Unlatch and open hood. If necessary, remove front bumper and hood.
4. Disconnect negative battery cable / terminal.

NOTE:

Record recovery waste oil level for future reference.

5. Using A/C machine (Figure 1), begin to evacuate A/C system.

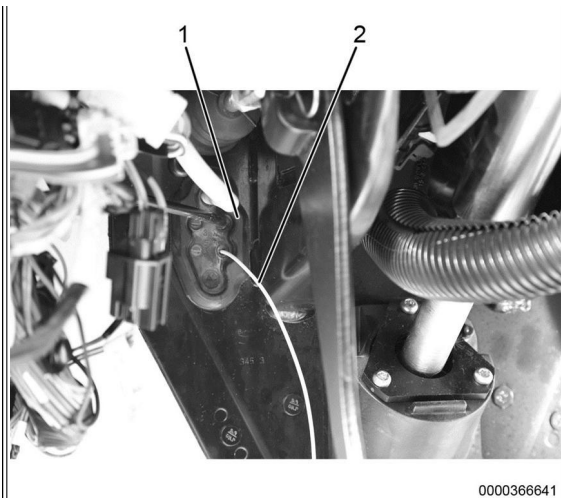

0000366641

Figure 2: Interior Accessory Grommet.

Item 1: Accessory grommet

Item 2: Kit-supplied wire

6. Remove driver-side interior kick panels.
7. Locate the interior accessory grommet (Figure 2, Item 1) just forward of the operator pedals.
8. Using pick tool, puncture hole through grommet to create a pass through location.
9. Insert the unterminated side of the kit-supplied wire (Figure 2, Item 2) through the pass through location of grommet, working towards the front of vehicle.

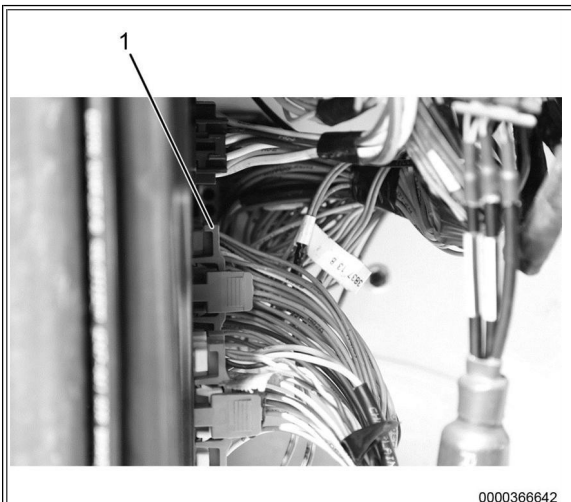

0000366642

Figure 3: Body Control Module (BCM) - J3 Connector.

Item 1: Connector

10. Access the vehicle BCM.
11. Locate RED J3 connector (Figure 3, Item 1) on vehicle BCM and disconnect.
12. Disengage the gray connector lock.



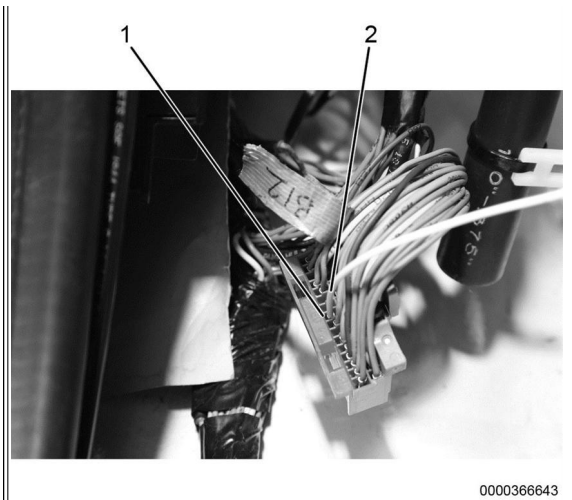

0000366643

Figure 4: Cavity B9.

Item 1: Cavity B9
Item 2: Kit-supplied harness

13. Route the terminated side of the kit-supplied wire through the J3 connector lock.
14. Populate the terminated side of the kit-supplied wire (Figure 4, Item 2) into cavity B9 (Figure 4, Item 1) of the connector.
15. Engage connector lock.
16. Connect J3 connector to BCM.
17. Inspect A/C machine to verify recovery is complete. Once complete, ensure there is no pressure in either line.
18. Remove air cleaner assembly.
19. From the engine compartment, insert the BCM wire into the kit-supplied split loom.

CAUTION:

To prevent component damage, do not route wiring / harness near any moving parts.

NOTE:

ONLY secure BCM wire / split loom harness assembly to 42-way harness located under the cowl tray at this point of procedure. Dependent on engine equipped, the secure points on the 42-way harness may vary.

20. Route the BCM wire / split loom harness assembly under the cowl tray and secure to existing 42-way harness with tie wrap(s) (under cowl tray **ONLY**):

- **MaxxForce 13 / N13 - engine equipped vehicles**, route following A/C discharge and liquid lines, working towards PT sensor area.
- **Cummins - engine equipped vehicles**, route following main engine harness working towards discharge and liquid lines located on passenger side of vehicle.

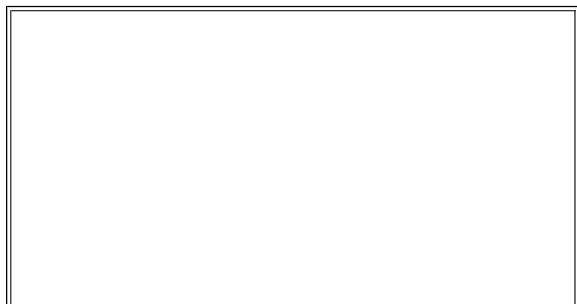

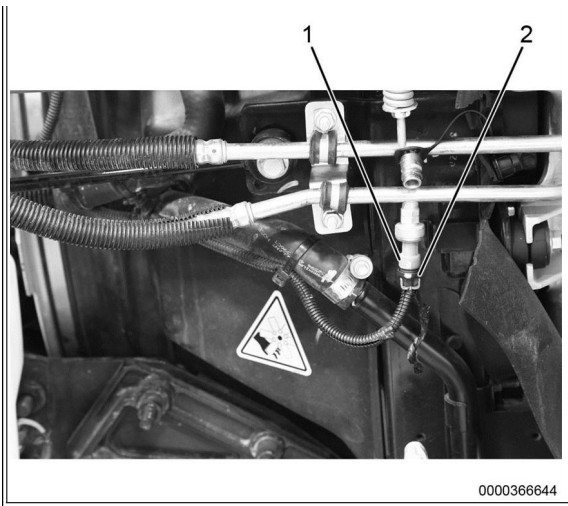

0000366644

Figure 5: Pressure Transducer (PT) Sensor.
 Item 1: PT sensor
 Item 2: Harness

21. Disconnect harness (Figure 5, Item 2) and remove the existing PT sensor (Figure 5, Item 1) from the liquid line.

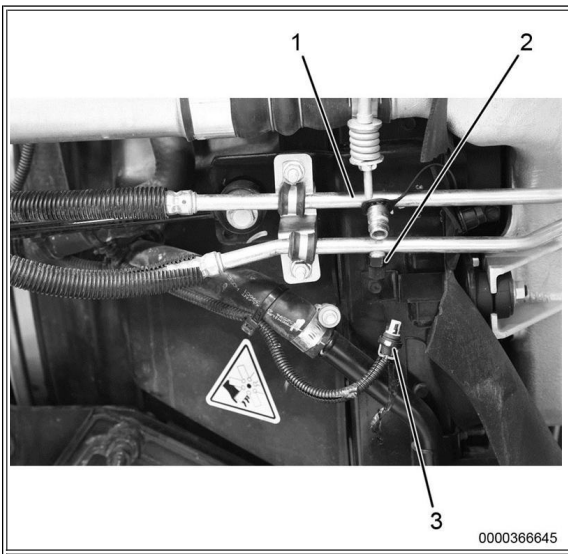

0000366645

Figure 6: AC Compressor Discharge Line - N13 Equipped ProStar 122.
 Item 1: Discharge line
 Item 2: Kit-supplied cap
 Item 3: PT sensor connector

NOTE:
 Save P-clamps for reuse.

- 22. **MaxxFace 13 / N13 - engine equipped vehicles**, remove compressor discharge line and discard.
- 23. **MaxxFace 13 / N13 - engine equipped vehicles**, install kit-supplied discharge line (Figure 6, Item 1). Secure using existing P-clamps and new tie-wraps.
- 24. **MaxxFace 13 / N13 - engine equipped vehicles**, install kit-supplied cap (Figure 6, Item 2) into liquid line. Tighten securely.



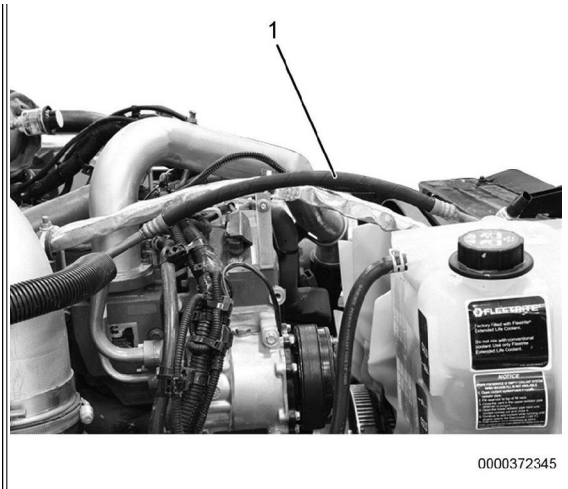

Figure 7: A/C Compressor Discharge Line - Cummins Equipped ProStar 122.

Item 1: Discharge line

NOTE:
Save P-clamps for reuse.

- 25. **Cummins - engine equipped vehicles**, remove compressor discharge line and discard.
- 26. **Cummins - engine equipped vehicles**, install kit-supplied discharge line (Figure 7, Item 1) at compressor.

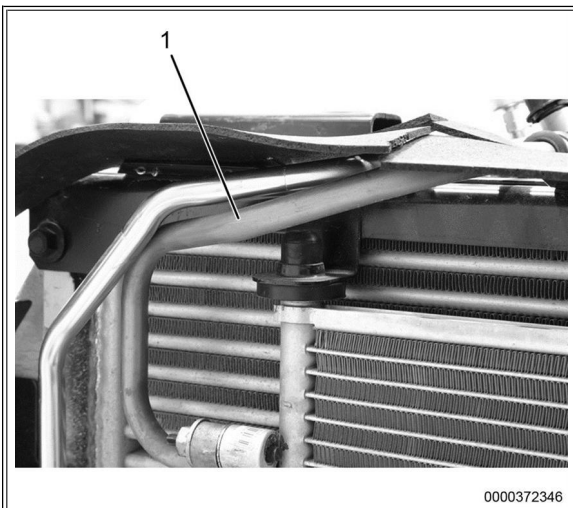

Figure 8: A/C Compressor Discharge Line - Cummins Equipped ProStar 122.

Item 1: Discharge line

CAUTION:
To prevent component / engine damage, never attempt to pry / bend the A/C discharge line.

NOTE:

Vehicles built before 14 April 2014 may be equipped with A/C lines that resemble those shown in Figure 8.

27. **Cummins - engine equipped vehicles**, ensure the discharge line (Figure 8, Item 1) is installed behind the liquid line:

- Position the discharge line under the liquid line.
- Install fastener at compressor. Ensure there are adequate gaps between the liquid and discharge lines.
- Once properly aligned, secure using existing P-clamps and new tie-wraps.
- Some production build levels may require the installation of the kit-supplied cap into liquid line. Tighten securely.

28. Remove A/C drier. Refer to appropriate engine service manual, service bulletin, or equivalent for detailed instruction.

29. Install kit-supplied A/C drier. Refer to appropriate engine service manual, service bulletin, or equivalent for detailed instruction.

30. Using A/C machine, begin both default vacuum and leak test procedures.

31. Inspect A/C machine to verify no leaks are present. Once complete, ensure there is no pressure in either line.

32. Remove existing PT sensor connector (Figure 6, Item 3) from loom and cut from harness jumper.

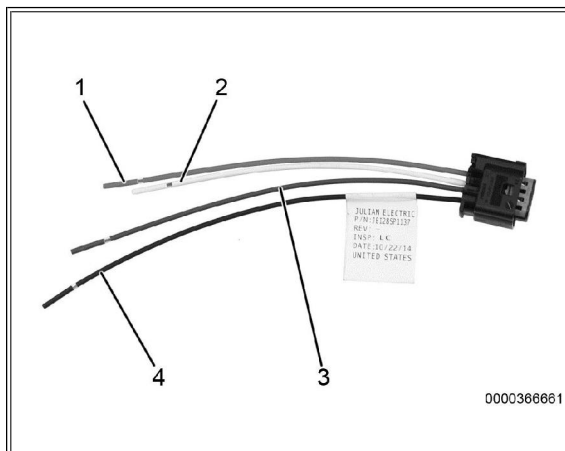

Figure 9: Pigtail

Item 1: Red (Kit) to Gray (Factory) Circuit K6DB
 Item 2: White (Kit) to White (Factory) BCM Circuit
 Item 3: Green (Kit) to Green (Factory) Circuit K77B
 Item 4: Black (Kit) to Gray (Factory) Circuit K9AA or K9AAA

33. Prepare existing PT jumper harness by trimming wire lengths to properly align to new PT sensor connector pigtails (Figure 9, Items 1-4).

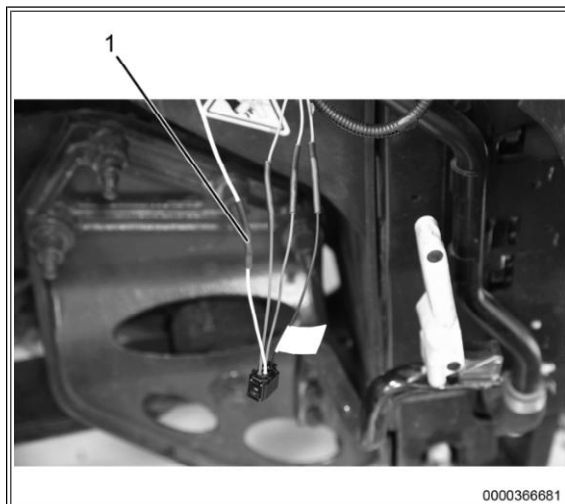
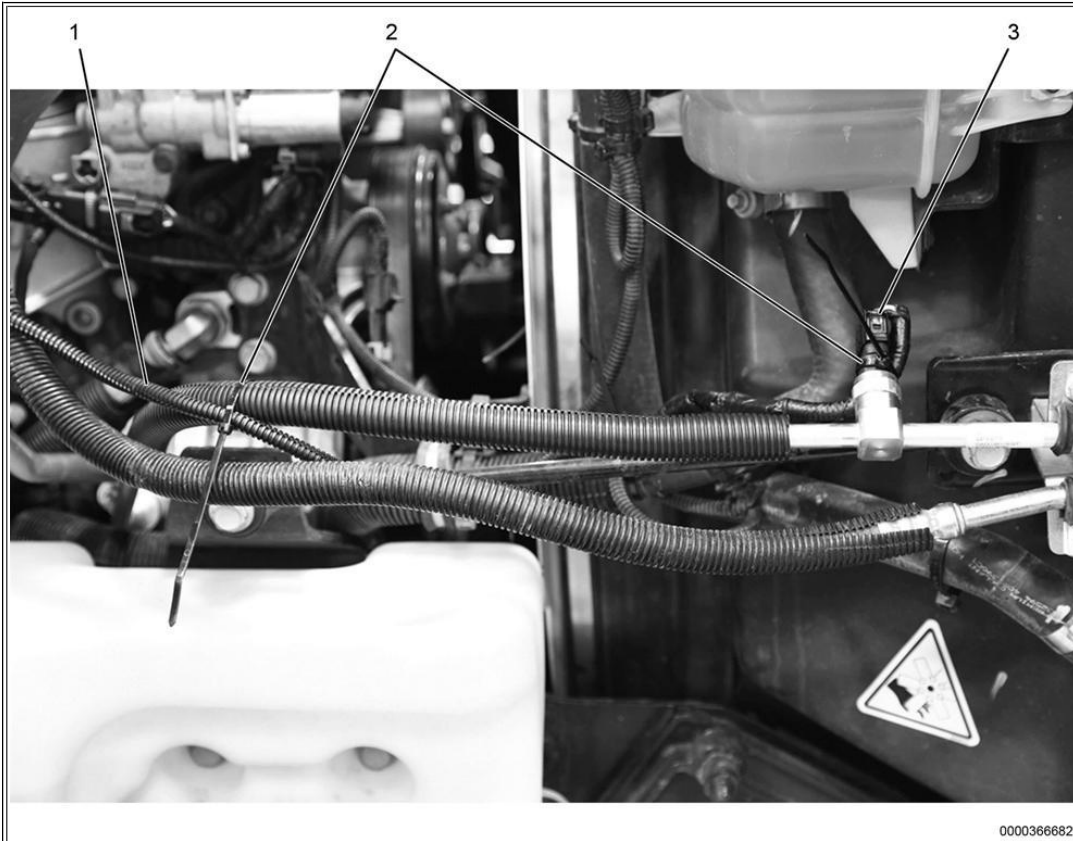

Figure 10: Pigtail Splice.

Item 1: Splice

34. Using Navistar approved Proper Procedure for Wire Repair / Splice Operation (SFN-0639), splice and solder (Figure 10, Item 1) the kit-supplied connector pigtails to the factory PT sensor harness.

35. Insert soldered wires carefully into split loom and secure with tape.



0000366682

Figure 11: Kit-Supplied PT Sensor - N13 Equipped ProStar 122.

- Item 1: Kit-supplied harness / loom
- Item 2: Tie-wrap (as needed)
- Item 3: Kit-supplied PT sensor connector



0000372347

Figure 12: Kit-Supplied PT Sensor - Cummins Equipped ProStar 122.

Item 1: Kit-supplied PT sensor connector
 Item 2: Tie-wrap (as needed)
 Item 3: Kit-supplied harness / loom

NOTE:

New PT sensor is pre-installed in discharge line.

36. Connect kit-supplied sensor connector (Figure 11, Item 3, or, Figure 12, Item 1 [Dependent On Engine Equipped]) to new PT sensor, pre-installed on new discharge line.

37. Secure sensor connector (Figure 11, Item 3, or, Figure 12, Item 1 [Dependent On Engine Equipped]) and harness / loom (Figure 11, Item 1, or, Figure 12, Item 3 [Dependent On Engine Equipped]) with tie-wraps (Figure 11, Item 2, or, Figure 12, Item 2 [Dependent On Engine Equipped]).

38. Inspect A/C machine to verify no leaks are present. Once complete, ensure there is no pressure in either line.

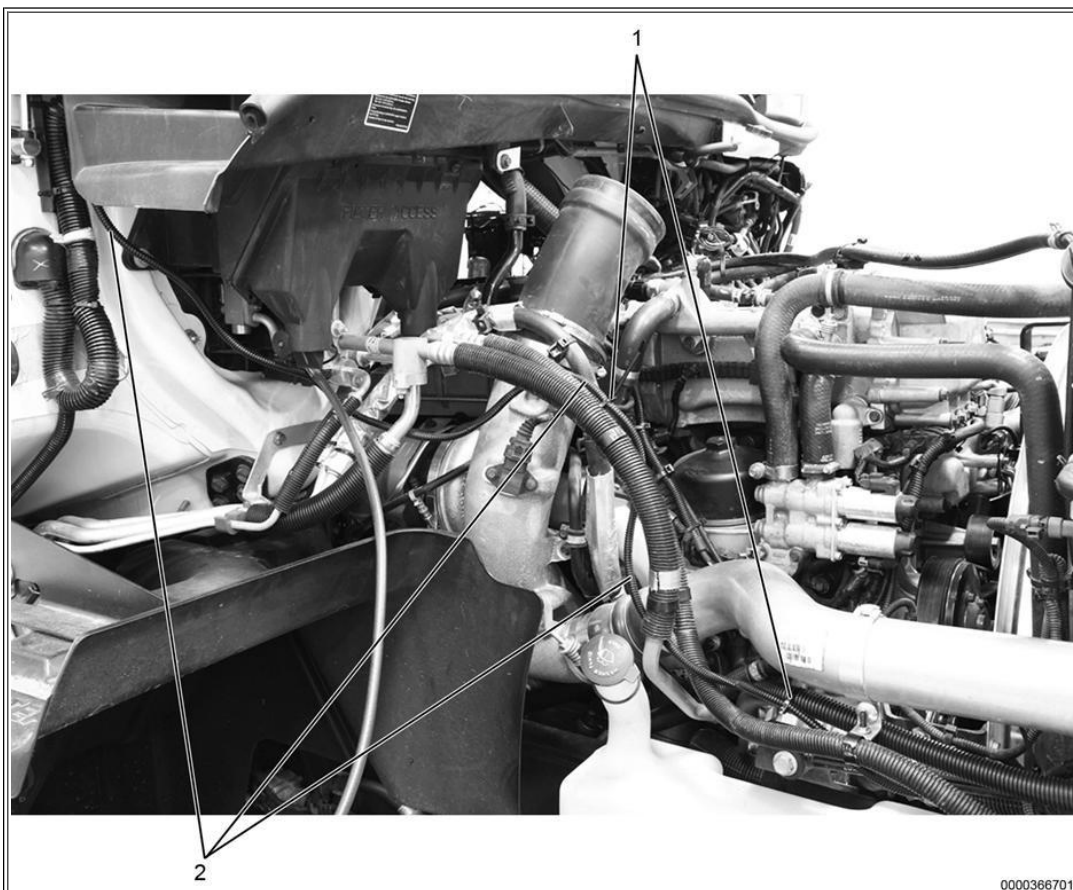

Figure 13: Kit-Supplied PT Sensor - N13 Equipped ProStar 122.

Item 1: Tie-wrap
 Item 2: Kit-supplied harness / loom

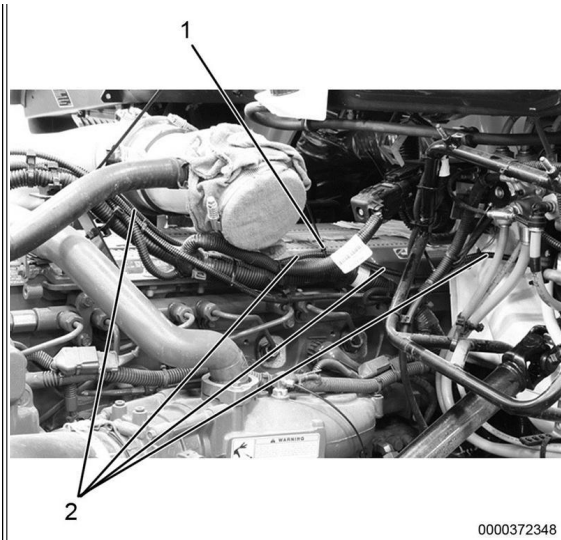

Figure 14: Kit-Supplied PT Sensor - Cummins Equipped ProStar 122.
 Item 1: Kit-supplied harness / loom
 Item 2: Tie-wrap

39. Continue securing harness (Figure 13, Item 2, or, Figure 14, Item 1 [Dependent On Engine Equipped]) towards cowl using tie-wraps (Figure 13, Item 1, or, Figure 14, Item 2 [Dependent On Engine Equipped]).

40. Install air cleaner assembly.

41. Add the volume of oil recovered and recharge system to specified fill capacity. If necessary, refer to [IK1900022](#) A/C Refrigerant and Oil Capacities.

42. Disconnect A/C machine.

CAUTION:
 To prevent component damage, do not secure wiring / harness near any moving parts.

NOTE:
 Following the securing of the kit-supplied wiring harness in the vehicle interior, it is considered a best practice to seal the hole punctured in the interior accessory grommet (Figure 2, Item 1) just forward of the operator pedals.

43. From the vehicle interior, secure kit-supplied wiring / harness.

44. Install driver-side interior kick panels.

45. Connect negative battery cable / terminal.

HVAC FEATURE CODES

New Feature Code	Old Feature Code (Being Replaced)	E-Fix	Description
0595BWY	0595BHK	1068	BC PROG, HVAC in Cab With Switch Controls (Bergstrom); High Side Pressure / Temp Transducer
0595BWZ	0595BJN	1069	

			BC PROG, HVAC 2010 In Sleeper (Behr) and Cab (Bergstrom); High Side Pressure / Temp Transducer
0595BXA	0595BMB	1070	BC PROG, HVAC In Sleeper (Bergstrom) and Cab (Bergstrom); High Side Pressure / Temp Transducer

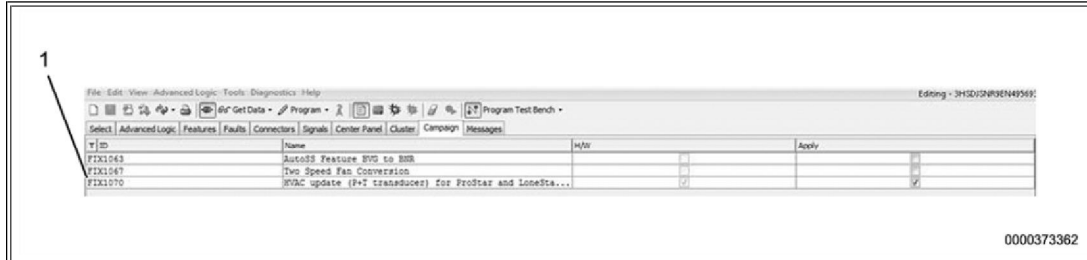

Figure 15: Campaign FIX.

Item 1: Campaign fix parameter

46. Using Diamond Logic Builder® (DLB) E-Fix, perform BCM programming steps:

- Launch DLB, connect to internet and verify latest release is installed.
- Connect the vehicle to DLB.
- Click on SELECT tab.
- Verify VIN selected is correct.
- Click on CAMPAIGN tab.
- Verify appropriate FIX parameter is shown (Figure 15, Item 1). Refer to the HVAC FEATURE CODES table listed above.
- Click on APPLY SELECTED CAMPAIGN button.
- Click on FEATURE tab.
- Verify correct parameter is selected.
- Depending on vehicle configuration (Day Cab, Conventional, No-Idle Sleeper), locate and check the new HVAC feature code. Refer to the HVAC FEATURE CODES table listed above.
- After checking on new HVAC feature code, click SAVE and PROGRAM VEHICLE.

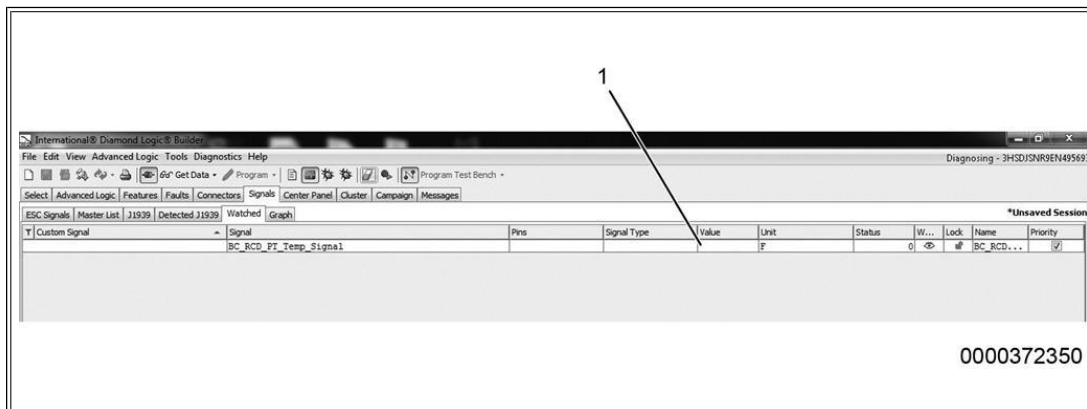
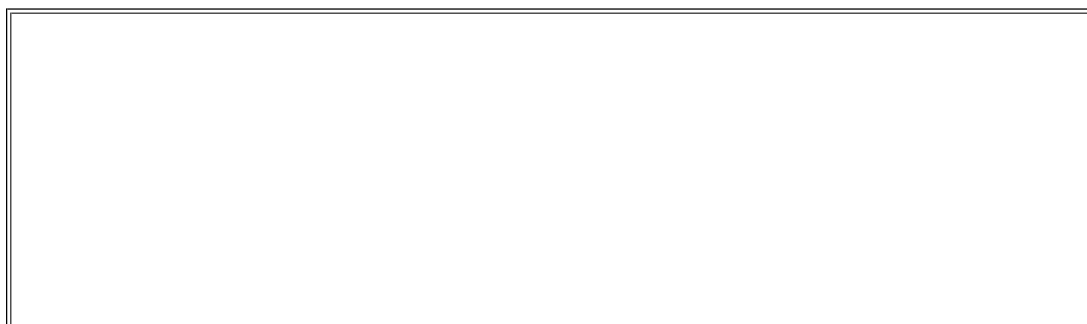

Figure 16: Incorrect Software Programming.

Item 1: Blank value



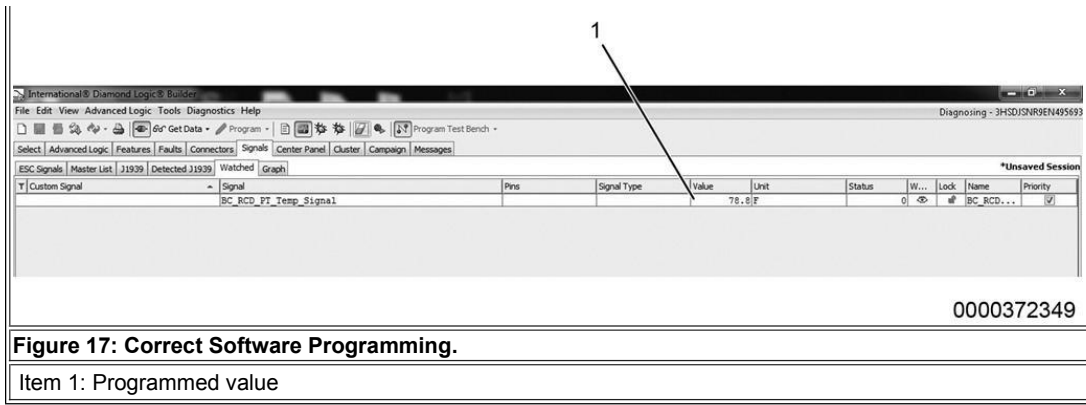

Figure 17: Correct Software Programming.

Item 1: Programmed value

47. Confirm BCM is properly programmed:

- If temperature signal is blank (Figure 16, Item 1), reprogram BCM.
- If temperature signal shows a value (Figure 17, Item 1), BCM programming is successful.

48. Close and latch hood. If necessary, install hood and front bumper.

NOTE:

If any wires are installed incorrectly or the PT connector is disconnected, the A/C compressor will not engage.

49. Start vehicle, activate A/C system, and verify the following:

- A/C compressor is engaged.
- A/C system is cooling adequately.
- Cycle key OFF and ON and verify A/C compressor is engaged.

50. Remove wheel chocks.

WARRANTY INFORMATION

Warranty Claim Coding:

Group:	19000 - Truck Air Conditioner
Noun:	909 - A/c high pressure switch

Standard Repair Time(s):

Step	Description	Chassis	Engine	SRT	Hours
1-50	A/C Pressure Transducer (PT) Switch Install	ProStar 122	N13	A99 - T1	1.7 Hrs
1-50	A/C Pressure Transducer (PT) Switch Install	ProStar 113	N13	A99 - T1	1.8 Hrs
1-50	A/C Pressure Transducer (PT) Switch Install	ProStar 122	MaxxForce 13	R20-1012U-21	1.7 Hrs
1-50	A/C Pressure Transducer (PT) Switch Install	ProStar 113	MaxxForce 13	R20-1012U	1.8 Hrs
1-50	A/C Pressure Transducer (PT) Switch Install	ProStar	Cummins ISX	R20-1012S	1.6 Hrs
1-50	A/C Pressure Transducer (PT) Switch Install	LoneStar	Cummins ISX	S20-1012S-20	1.6 Hrs

OTHER RESOURCES

- [Master Service Information Site](#)
- [IK1900156 - Pre-2010 A/C HVAC Service Resource Center](#)
- [IK1900228 - 2010 and Newer Vehicle Air Conditioning Diagnostics](#)

 Hide Details

Feedback Information

Viewed: 4762
Helpful: 21
Not Helpful: 3

No Feedback Found