



Service Bulletin

PRELIMINARY INFORMATION

Subject: Exhaust Leak or Vibration/Rattle Noise at Approximately 900 RPM, Fuel Smell, White Smoke, Oily Substance on Exhaust Downpipe

Models: 2011-2015 Chevrolet Express 2500/3500/4500, Silverado 2500HD/3500HD
2011-2015 GMC Savana 2500/3500/4500, Sierra 2500HD/3500HD
Equipped with 6.6L Duramax® Diesel Engine (RPOs LML or LGH)

Attention: This PI also applies to any of the above models that may be Israel Export vehicles.

This PI has been revised to update the Important statement under Verify Condition Corrected. Please discard PI0235I.

Condition/Concern

Some customers may comment on fuel smell and/or white smoke intermittently when driving the vehicle, usually after coming to a stop. They also may comment on a possible exhaust leak or on rare occasions a vibration/rattle noise at approximately 900 RPM. Upon further diagnosis, a technician may notice what appears to be an oily substance at the bottom of the turbocharger's exhaust downpipe.

The cause of this condition may be that the joint for the turbocharger to turbocharger exhaust pipe or turbocharger exhaust pipe exhaust downpipe connection may be loose or out of position. The fuel smell or appearance of an oily substance could be from the Hydro-Carbon Injection process used during the diesel particulate filter (DPF) regeneration event (Note: the substance is not DEF (urea), as it is injected further down the exhaust stream).

Recommendation/Instructions

To correct this condition, the exhaust system must be aligned until the flanges between the turbocharger exhaust pipe and the downpipe are flush and parallel with no or minimal load or force applied.

1. Allow the exhaust system to cool down.

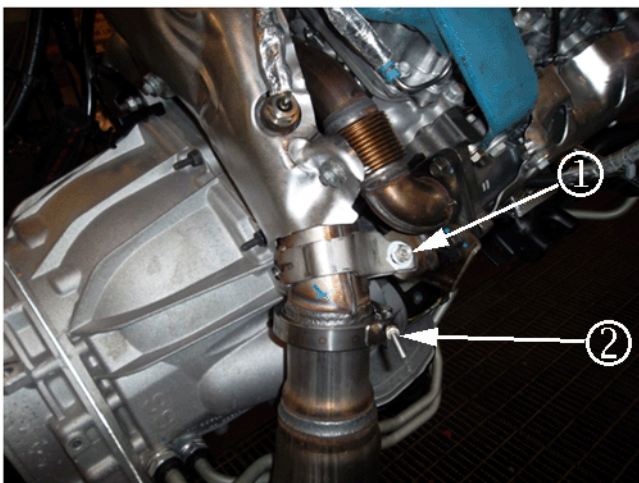

2. Remove and discard the exhaust clamp between the downpipe and the turbocharger exhaust pipe (2) as shown in the illustration above.

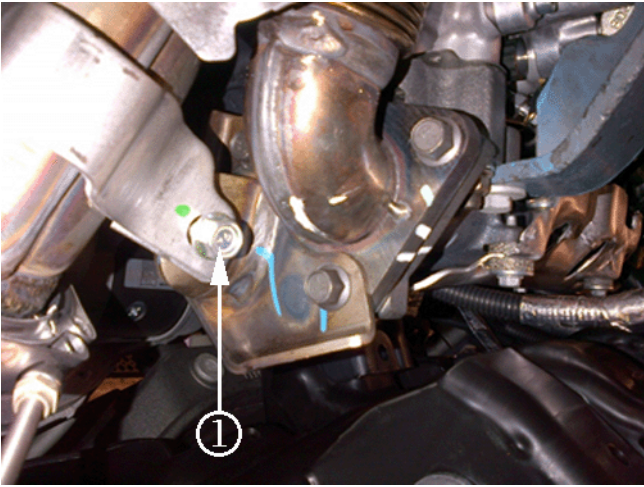

3. If the joint has a gap on either the left or right side, loosen or remove the turbo exhaust pipe mounting bolt (1) as shown in the illustration above.

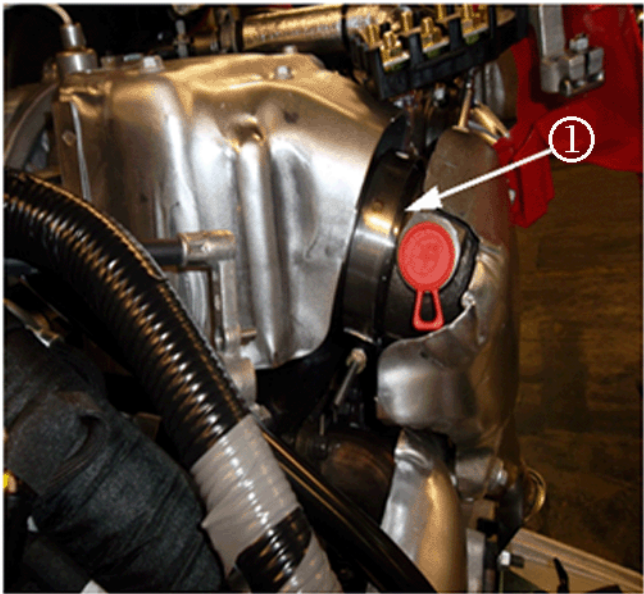

4. Remove and discard the exhaust clamp at the turbo to turbo exhaust pipe (1). This can allow the turbo exhaust pipe to be rotated slightly to close the gap as shown in the illustration above.

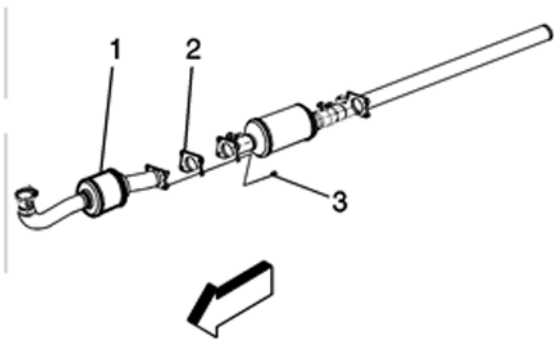

5. Loosen or disconnect the four flange mid-joint bolts located after the catalytic converter.

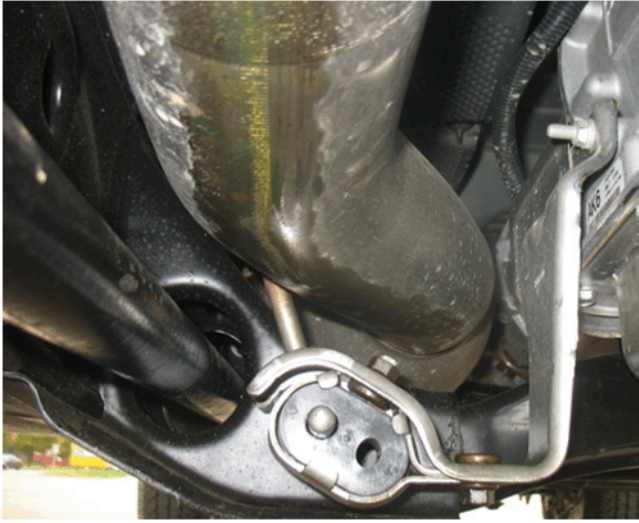

6. Verify that the exhaust pipe hanger at the transmission is mounted in the outer insulator hole as shown in the illustration above.

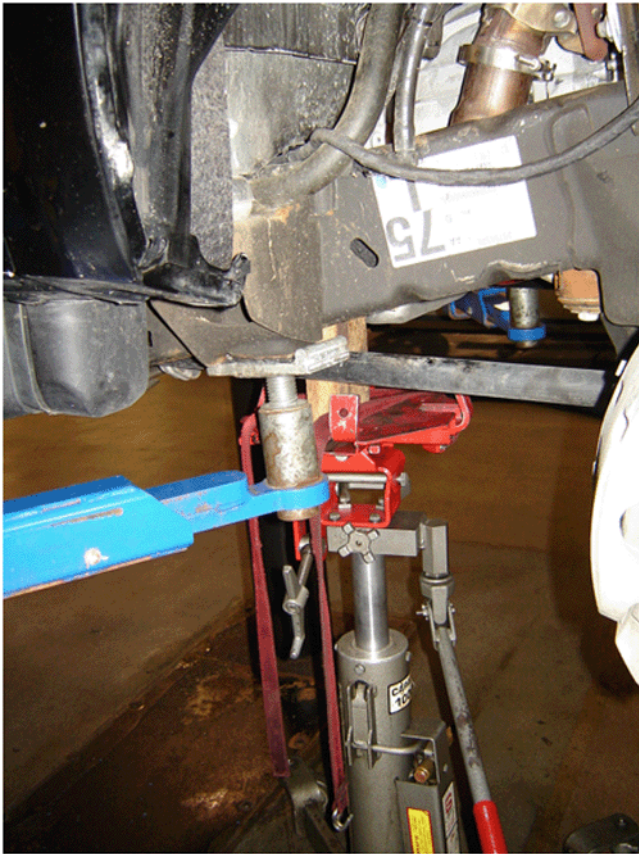

7. Using a transmission jack, align the exhaust pipe, downpipe and the turbocharger exhaust pipe flanges until all mounting joints and the flanges are flush and parallel with no or minimal load or force applied. This could include adjusting the mounts as necessary, allowing the flanges to sit flush with the exhaust in a neutral state, using care not to compromise clearances around the exhaust.



8. Visually verify the joint has good contact completely around the downpipe and the turbocharger exhaust pipe as shown in the illustration above.

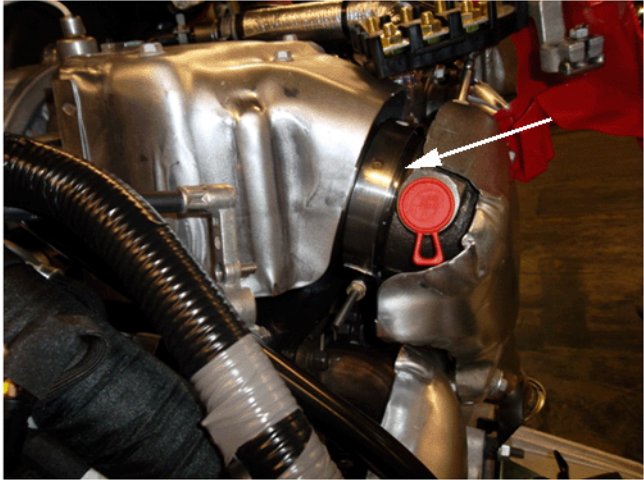

9. After alignment of all the joints, install and tighten a new clamp at the turbocharger (if removed earlier).



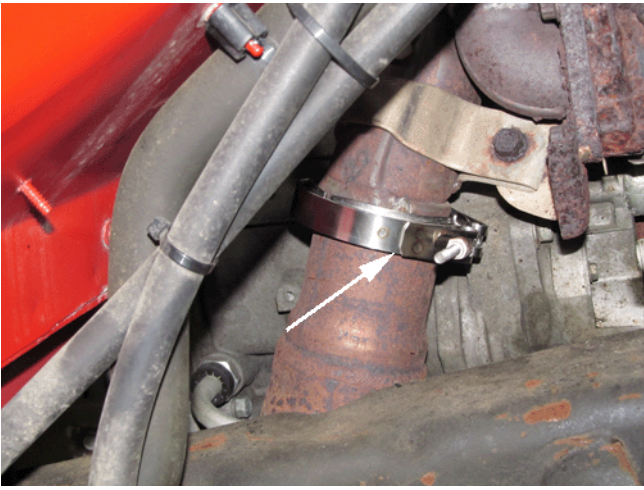

10. Install the gasket and updated exhaust clamp, and tighten the exhaust clamp between the downpipe and the turbocharger exhaust pipe. When installing place the gaps of the v-clamp away from the original leak area if possible.
11. If needed, replace the gasket for the four bolt flange mid-joint and tighten.

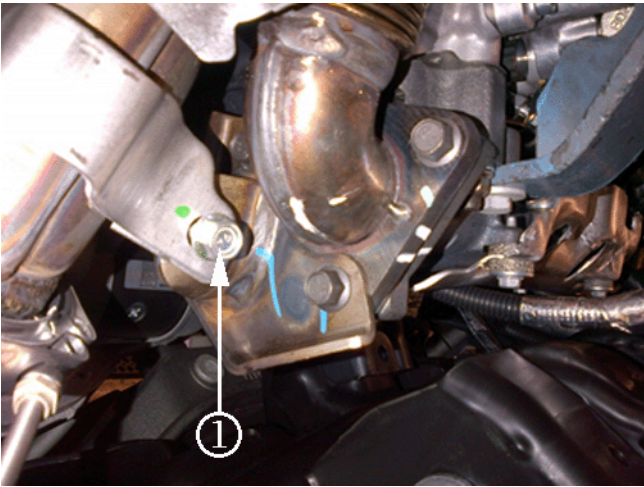

12. Install the mounting bolt (1). If the mounting bracket was removed, align and install the bracket. If the bolt will not line up, bend or shim the bracket until alignment is possible.

Verify Condition Corrected

On 2011 trucks – If the ECM calibration has not been updated on or after 6-11-12, update the calibration. This will allow the Tech 2 to be used to perform a stationary Service Regeneration that will activate the hydrocarbon injector.

Important: For 2012-2013 trucks, the Tech 2 can be used to perform a stationary Service Regeneration that will activate the hydrocarbon injector without updating the calibration. For 2014-2015 trucks, utilize the GDS 2.

When inspecting for exhaust odor, make sure there are no other diesel vehicles operating nearby. It is very easy to notice another vehicle's exhaust odor.

If the above alignment procedure does not correct the condition, the turbocharger exhaust pipe may need to be replaced on trucks built prior to the breakpoints listed below with an updated turbocharger exhaust pipe with a pilot flange. If the turbocharger exhaust pipe has the new flange, you should not need to replace it. Refer to the Turbocharger Exhaust Pipe Replacement procedure in SI.

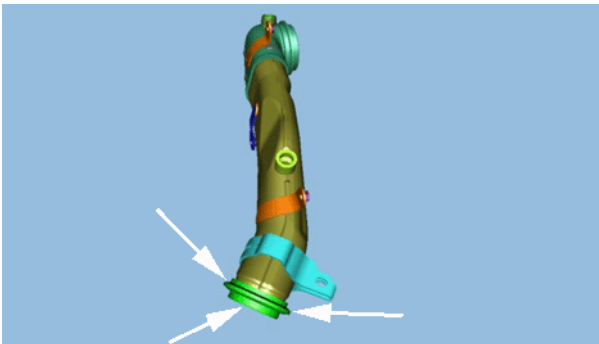

Note: The illustration above is the updated turbocharger exhaust pipe with a pilot flange.

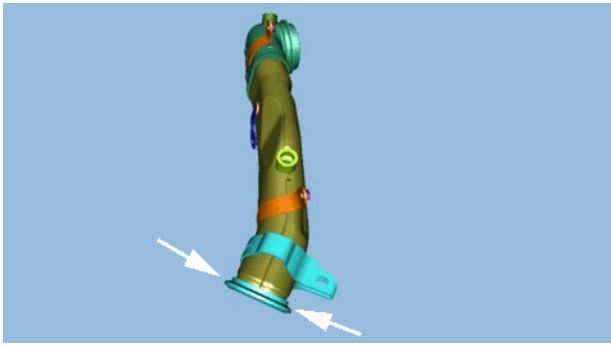

Note: The illustration above is the turbocharger exhaust pipe without a pilot flange.

Plant	VIN Breakpoint
Ft Wayne	BZ204950
Flint	BF151767
Wentzville	B1112382

In most cases it will not be necessary to replace the exhaust downpipe/catalytic converter assembly for this condition. However if the mating flange on the exhaust downpipe/catalytic converter assembly is not true, it is possible a leak may occur.



This can be inspected easily by placing a gauge block flush against the flange and inspect for excessive gaps or damage to the flange.

If there are gaps, the converter may need replacing, but the new gasket should compensate for minor surface variation. It is preferred that the alignment process is attempted prior to replacing the converter. There have been very few cases that required the converter to correct this condition.

Parts Information

Part Number	Description
15126137	Gasket, Exhaust Manifold Pipe (4-HOLE Gasket)
12643610	Pipe, Turbocharger Exhaust
97354769	Clamp, TURBO EXH PIPE
22967814	Turbo pipe to converter Exhaust Clamp and Gasket Kit
22887212	Converter (should not be required in most cases)

Warranty Information

For vehicles repaired under the Emission coverage, use the following labor operation. Reference the Applicable Warranties section of Investigate Vehicle History (IVH) for coverage information.

Labor Operation	Description	Labor Time
4080238*	Re-align Exhaust Pipe/Replace Gasket	1.5♦hrs
Add	To Replace the Turbocharger Exhaust Pipe	1.2♦hrs (G Van)
		3.7♦hrs (C Truck)
		4.1♦hrs (K Truck)
*This is a unique Labor Operation for Bulletin use only. It will not be published in the Labor Time Guide.		

GM bulletins are intended for use by professional technicians, NOT a "do-it-yourselfer". They are written to inform these technicians of conditions that may occur on some vehicles, or to provide information that could assist in the proper service of a vehicle. Properly trained technicians have the equipment, tools, safety instructions, and know-how to do a job properly and safely. If a condition is described, DO NOT assume that the bulletin applies to your vehicle, or that your vehicle will have that condition. See your GM dealer for information on whether your vehicle may benefit from the information.



WE SUPPORT VOLUNTARY TECHNICIAN CERTIFICATION